

Labelling of the cytoplasmic domains of ovine rhodopsin with hydrophilic chemical probes

Paul L. BARCLAY and John B. C. FINDLAY*

Department of Biochemistry, University of Leeds, Leeds LS2 9JT, U.K.

(Received 27 October 1983/Accepted 1 February 1984)

The disposition of polypeptide chain of ovine rhodopsin in the photoreceptor disc membrane was investigated by using two hydrophilic reagents, 3,5-di-[¹²⁵I]iodo-4-diazobenzenesulphonate ([¹²⁵I]DDISA) and [¹⁴C]succinic anhydride. Both reagents were used to modify rhodopsin in intact disc membranes under conditions where no loss of *A*₅₀₀ occurred. Reaction of [¹²⁵I]DDISA with rhodopsin approached completion after 30 min. Binding was saturated at a 75-fold molar excess of reagent, which gave binding ratios of up to 2 mol/mol of rhodopsin. Proteolysis of rhodopsin, using *Staphylococcus aureus* V8 proteinase, yielded two membrane-bound fragments, both of which contained bound radioactive probe. Subsequent CNBr cleavage of these fragments produced five radiolabelled peptides which corresponded to the C-terminal region and cytoplasmic loops of rhodopsin. Similar studies with [¹⁴C]succinic anhydride also gave binding ratios of up to 2 mol/mol of rhodopsin. Sequencing of the [¹⁴C]succinylated peptides identified the location of the reactive sites as lysine residues 66, 67, 141, 245, 248, 311, 325 and 339 in the polypeptide chain. Non-permeability of both probes was demonstrated by the absence of any radioactivity associated with the intradiscal *N*-terminal glycopeptide. Sonication of membranes in the presence of [¹²⁵I]DDISA led to the incorporation of label in this peptide.

The primary structure of the integral membrane protein rhodopsin has been determined (Ovchinnikov, 1982; Hargrave *et al.*, 1983; Brett & Findlay, 1983) and the sequence information has been used to predict the secondary structure of the molecule (Eliopoulos *et al.*, 1982; Hargrave *et al.*, 1983; Pappin *et al.*, 1983). These predictions give some indication of the spacial orientation of the polypeptide chain in the bilayer, suggesting seven transmembrane 'broken' helical segments, with small sections of the protein, at the *N*- and *C*-termini, in the aqueous phase. To substantiate these predictions, however, much experimental evidence is required on the disposition of the polypeptide chain with respect to the lipid bilayer.

Histochemical evidence and lectin-binding studies support the view that the glycosylated *N*-terminal region is located in the intradiscal aqueous phase (Rohlich, 1976; Clark & Molday,

1979). The *C*-terminal portion is available for phosphorylation by an enzyme system present in the cytosol (Sale *et al.*, 1978; Hargrave *et al.*, 1980). Proteolysis of sealed disc membranes with *Staphylococcus aureus* V8 proteinase and thermolysin cleaves rhodopsin internally in one particularly susceptible region, to give two membrane-bound fragments (Saari, 1974; Findlay *et al.*, 1981). In addition, the same region can be modified by transglutaminase (Poher *et al.*, 1978). However, evidence for a further two loops presumably exposed at the cytoplasmic membrane surface is scarce. Proteolytic cleavage with subtilisin (Dratz *et al.*, 1979) and papain (Sale *et al.*, 1977) are indicative of further loops, but the cleavage sites have not been established. Much remains to be done, therefore, before the putative organization of the protein in the bilayer can be confirmed and further refined. Chemical modification of rhodopsin with small impermeant probes may provide a means by which this might be achieved. Some work along these lines has been reported by Raubach *et al.* (1974) using [¹⁴C]isethionyl acetimide and choline acetimidate, and by Mas *et al.* (1980) using the photoactivatable probe *N*-(4-

Abbreviations used: DDISA, 3,5-di-iodo-4-diazobenzenesulphonate; SDS, sodium dodecyl sulphate; AEAP, aminoethylaminopropyl.

* To whom correspondence and requests for reprints should be addressed.

azido-2-nitrophenyl)-2-aminoethane-[³⁵S]sulphonate (NAP-aurine).

We have employed two impermeant chemical probes ([¹²⁵I]DDISA and [1,4-¹⁴C]succinic anhydride) to identify those regions of the polypeptide exposed at the cytosolic surface of the disc membrane. [¹²⁵I]DDISA was previously synthesized by Helmkamp & Sears (1970) for use as a surface label for the erythrocyte membrane. Diazonium salts are fairly reactive species, and are thought to bind covalently to proteins at tyrosine, histidine and lysine residues, and possibly also with cysteine and arginine side chains. The probe has been used successfully as a vectorial label for lymphocytes (Spiva & Sears, 1981), platelets (Tam *et al.*, 1980), kidney microvillar membrane (Booth & Kenny, 1980), sarcoplasmic reticulum (Yu *et al.*, 1976) and brain synaptic membranes (Law *et al.*, 1981).

Succinic anhydride, which reacts with free amino groups and, more unusually, with a reactive threonine in glyceraldehyde-3-phosphate dehydrogenase (Allen & Harris, 1976), has been used with rod outer segment membranes (DeGrip, 1974). Extensive modification of the membrane resulted in disruption of the protein structure with a resulting loss in spectral integrity (DeGrip, 1974). However, to our knowledge, limited modification of proteins with [¹⁴C]succinic anhydride has received little attention (Allen & Harris, 1976). It would appear to be suitable for the study of membrane proteins, which only a small number of lysine residues would be available for modification.

Materials and methods

Materials

[1,4-¹⁴C]succinic anhydride and carrier-free Na¹²⁵I were obtained from Amersham International; all other reagents were as described in Brett & Findlay (1983) and Pappin & Findlay (1984).

Preparation of [¹²⁵I]DDISA

Di-iodosulphanilic acid was synthesized from sulphanilic acid by the method of Helmkamp & Sears (1970), decolorized with activated charcoal, and purified by two recrystallizations from 0.1 M-NaHCO₃ (iodine content 59.5%; theoretical 59.7%). [¹²⁵I]DDISA was prepared from di-iodosulphanilic acid (34 mg) by isotope exchange using carrier-free Na¹²⁵I (1 mCi) and ICl reagent (200 μl), followed by diazotization with NaNO₂ (6.4 mg). [¹²⁵I]DDISA was identified by coupling to 1-naphthol [10 μl added to 50 μl of 10% (w/v) 1-naphthol in 50% (v/v) ethanol], followed by t.l.c. on silica gel G, with methanol/diethyl ether (1:4, v/v) as solvent. It gave a single radioactive spot (*R_F* 0.67) corresponding to the [¹²⁵I]DDISA-1-naph-

thol conjugate. The concentration and specific radioactivity of [¹²⁵I]DDISA was determined spectrophotometrically after coupling to 1 mM-1-naphthol, using an absorption coefficient at 430 nm of 670 M⁻¹·cm⁻¹. The specific radioactivity was determined to be approx. 10 Ci/mol when first synthesized, and was redetermined before each experiment.

Preparation of photoreceptor disc membranes

Intact photoreceptor disc membranes were prepared from dark-adapted sheep eyes according to the method of Brett & Findlay (1979), using 0.1 M-sodium phosphate buffer, pH 7.4, in place of 0.1 M-Tris/HCl buffer, pH 7.4. All procedures were performed at 4°C, in dim red light, unless otherwise stated.

Rhodopsin content of the photoreceptor disc membranes was determined spectrophotometrically, as in Pappin & Findlay (1984).

Labelling with [¹²⁵I]DDISA

Photoreceptor membranes were suspended to 0.5–2.0 mg/ml in 0.1 M-sodium phosphate buffer, pH 7.4, and incubated at 4°C with portions of [¹²⁵I]DDISA, dissolved in distilled water. Initial experiments designed to investigate reaction conditions used precipitation with trichloroacetic acid to measure [¹²⁵I]DDISA incorporation into disc membranes. Samples from the reaction mixture, containing 25–250 μg of protein, were mixed with 1.0 ml of ice cold 10% (w/v) trichloroacetic acid. The precipitated material was centrifuged, and washed by centrifugation and resuspension with two 1 ml portions of 10% (w/v) trichloroacetic acid. Radioactivity bound to the precipitate was determined with an Intertechnique CG4000 gamma counter. In later experiments, the labelling reaction was terminated by addition of a large molar excess of 100 μM-histidine, pH 7.4, and the membranes were washed twice by centrifugation in this solution, prior to assay by precipitation with trichloroacetic acid.

The incorporation of [¹²⁵I]DDISA into rhodopsin was determined by SDS/polyacrylamide-gel electrophoresis. Labelled membranes were washed twice by centrifugation in 100 mM-histidine, pH 7.4, and dissolved in 1% (w/v) SDS, 10% (v/v) glycerol, 1% (v/v) 2-mercaptoethanol, 0.05 M-Tris/HCl buffer, pH 8.8, containing Bromophenol Blue marker dye. Samples, containing 25–100 μg of protein, were loaded on gradient slab gels (5–30% acrylamide), and subjected to electrophoresis at 60 V for 18 h, with Tris/glycine running buffer (0.025 M-Tris, 0.192 M-glycine, 0.1% SDS), pH 8.4, according to the method of Laemmli (1970). Gels were stained and scanned as described previously (Brett & Findlay, 1979) and cut into 3 mm slices for

the determination of radioactivity in a gamma counter.

Labelling with [^{14}C]succinic anhydride

[^{14}C]Succinic anhydride (50 μCi) was mixed with sufficient unlabelled succinic anhydride to give a 20-fold molar excess over primary amino groups in photoreceptor membranes. This was added slowly, over 30 min, to a suspension of photoreceptor disc membranes (5 mg/ml) in 0.1 M-sodium phosphate, pH 7.4, at 24°C. After the final addition of succinic anhydride, the reaction mixture was incubated for a further 30 min at 4°C, before washing the membranes three times by centrifugation in 0.1 M-sodium phosphate, pH 7.4. Radioactivity was measured in a Beckman LS230 liquid scintillation counter, with Triton/toluene scintillation cocktail [Triton/toluene, 1:2, v/v]; 4.0 g of 2,5-diphenyloxazole and 0.2 g of 1,4-bis-(5-phenyloxazol-2-yl)benzene per litre].

Proteolysis, carboxymethylation and delipidation of rhodopsin

Labelled photoreceptor disc membranes were digested with 2% (w/w) *S. aureus* V8 proteinase, the detergent-solubilized protein was carboxymethylated and the V8L and V8S fragments were isolated by the procedures described in Brett & Findlay (1983). Cleavage of V8L and V8S with a 50-fold excess of CNBr and the purification and sequencing of the various peptides have been described previously (Brett & Findlay, 1983; Pappin & Findlay, 1984).

Results

Characterization of reaction with [^{125}I]DDISA

In order to characterize the labelling of disc membranes with [^{125}I]DDISA, it was necessary to develop a suitable quenching agent, which could be used to terminate the reaction rapidly. The

results obtained for the various compounds tested are shown in Table 1. The reagent proposed by Edwards *et al.* (1979), 1-naphthol, was found to increase [^{125}I]DDISA incorporation into disc membranes. This compound is hydrophobic, and when coupled to [^{125}I]DDISA may form an amphipathic detergent-like product which partitions into, and may disrupt, the bilayer. Histidine therefore was chosen as the most suitable reagent, because of its ability to quench the reaction, its good solubility in aqueous buffers and the formation of stable diazoamino linkages with [^{125}I]DDISA.

[^{125}I]DDISA incorporation into disc membranes reached a maximum after 20–30 min, with more than half of the reaction occurring in the first 2 min (Fig. 1). Subsequent experiments used an incubation time of 30 min.

Labelling increased in proportion to the concentration of the reagent, up to a level of 75-fold molar excess of [^{125}I]DDISA over rhodopsin (Fig. 2). Modified membranes washed extensively with 100 mM-histidine solution, gave values of 14 mol of [^{125}I]DDISA equivalents per mol of rhodopsin. Subsequent analysis of this material by precipitation with trichloroacetic acid and SDS/polyacrylamide-gel electrophoresis gave values of 7 and 2 mol of [^{125}I]DDISA per mol of rhodopsin, respectively. Differences between membranes washed in histidine buffer only and trichloroacetic acid-precipitated membranes may be due to the removal of non-covalently bound probe, and the hydrolysis of acid-labile bonds between [^{125}I]DDISA and the membrane. Trichloroacetic acid precipitation showed a higher level of [^{125}I]DDISA incorporation than did SDS/polyacrylamide-gel electrophoresis, mainly due to the contribution of labelled phospholipids.

Proteolysis of [^{125}I]DDISA-modified photoreceptor membranes with *S. aureus* V8 proteinase revealed that radioactivity occurred in both of the

Table 1. *Quenching agents*

[^{125}I]DDISA (specific radioactivity 8.3 Ci/mol) at a final concentration of 0.27 mM was preincubated with various quenching agents for 30 min at 4°C, before incubation with photoreceptor membranes (1 mg of protein/ml) for a further 20 min. For the control samples [^{125}I]DDISA was preincubated with 0.1 M-sodium phosphate buffer, pH 7.4. Naphthol and tyrosine were used at relatively low concentrations, due to their limited solubility in aqueous buffers.

Quenching agent	Final concn. (mM)	Molar excess over DDISA	DDISA bound (c.p.m./ μg)		
			Membranes (trichloroacetic acid precipitate)	Rhodopsin (gels)	Average (% of control)
Control	—	—	410	156	100
Naphthol	0.4	$\times 2$	480	195	120
Tyrosine	0.4	$\times 2$	160	116	60
Histidine	4.0	$\times 20$	50	40	20
Lysine	4.0	$\times 20$	40	20	10

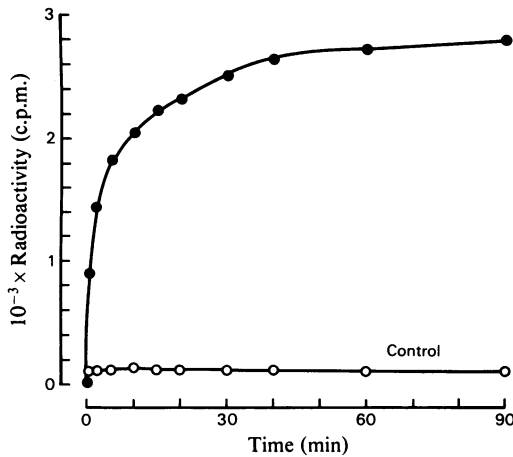

Fig. 1. Time course for [125 I]DDISA labelling of photoreceptor membranes

[125 I]DDISA (specific radioactivity 7.0 Ci/mol) at a final concentration of 0.5 mM was incubated with photoreceptor disc membranes (1 mg of protein/ml) at 4°C, and at the appropriate times 100 μ l aliquots were removed, and the reaction was stopped by pipetting into 1 ml of 100 mM-histidine/0.1 M-sodium phosphate buffer, pH 7.4. As a control for the labelling reaction, [125 I]DDISA was preincubated with 100 mM-histidine before incubation with disc membranes.

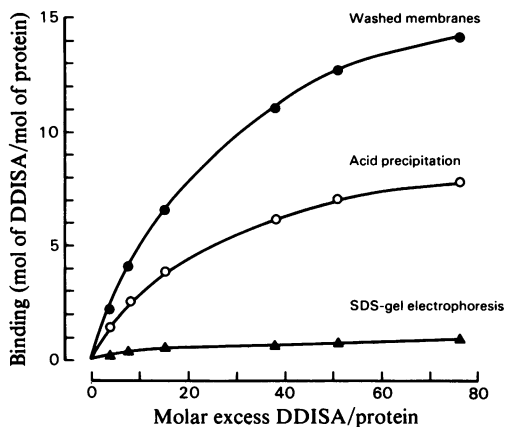

Fig. 2. Concentration curve for [125 I]DDISA labelling of photoreceptor membranes

[125 I]DDISA (specific radioactivity 4.2 Ci/mol) at appropriate concentrations was incubated with photoreceptor membranes (0.5 mg of protein/ml) for 30 min at 4°C. The reaction was stopped by addition of histidine to 60 mM. Incorporation of [125 I]DDISA into protein was assayed using washed membranes, trichloroacetic acid precipitated membranes, and SDS/polyacrylamide-gel electrophoresis.

membrane-bound fragments (Fig. 3). Experiments with [14 C]succinylated protein gave a similar result.

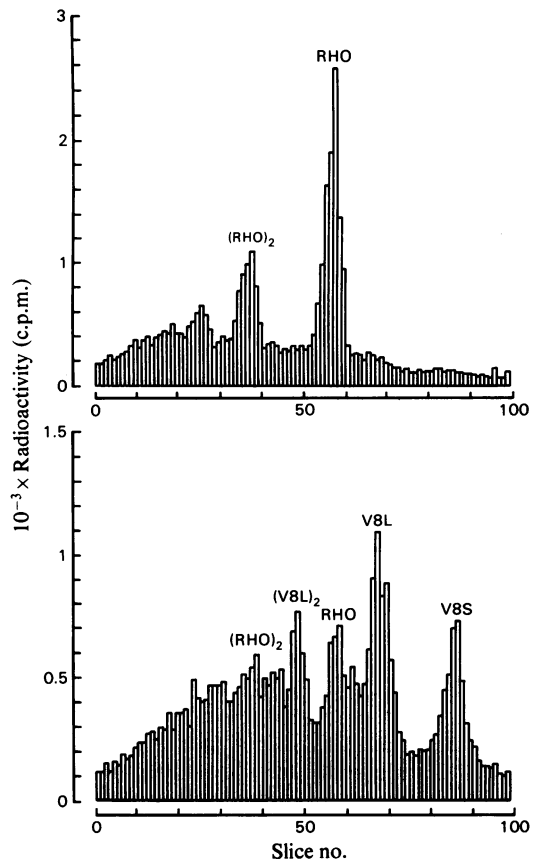

Fig. 3. Proteolysis of [125 I]DDISA-labelled photoreceptor membranes with *S. aureus* V8 proteinase

[125 I]DDISA-labelled rhodopsin (1.1 mol of DDISA/mol) in photoreceptor membranes (resuspended to 2 mg of protein/ml) was cleaved with 2% (w/w) *S. aureus* V8 proteinase for 3 h at 30°C. Digestion was analysed by SDS/polyacrylamide-gel electrophoresis on a 5–20% gradient acrylamide gel, with a gel loading of 103 μ g of protein. Abbreviation used: RHO, rhodopsin.

Characterization of the cytoplasmic surfaces of rhodopsin

Rhodopsin modified with [125 I]DDISA or [14 C]-succinic anhydride was subject to proteolytic and chemical cleavage, to identify which regions of the polypeptide chain were accessible to the reagent. The seven-residue peptide released into the supernatant by digestion with *S. aureus* V8 proteinase was not labelled with either reagent. The two membrane-bound fragments were carboxymethylated and separated by gel filtration on Sephadex LH60 (Fig. 4).

(i) *V8S* fragment. CNBr cleavage of [125 I]-DDISA-labelled V8S or [14 C]succinyl-V8S and subsequent chromatography on Sephadex LH60 gave the profiles shown in Figs. 5 and 6.

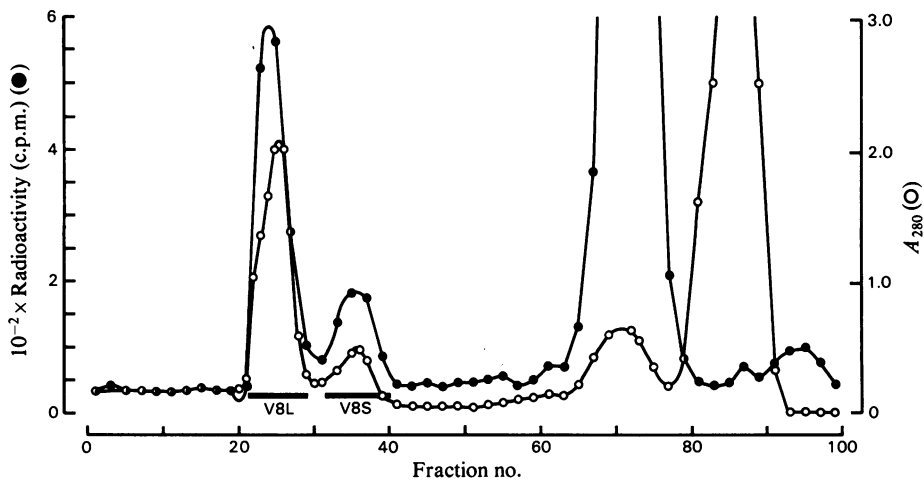

Fig. 4. Purification of [^{14}C]succinyl-labelled V8L and V8S on Sephadex LH60

V8-cleaved [^{14}C]succinyl-rhodopsin (1.5 mol of succinic anhydride/mol) in photoreceptor membranes was carboxymethylated, lyophilized, dissolved in 5 ml of 90% formic acid/acetic acid/chloroform/ethanol (1:1:2:1, by vol.), and applied to a column of Sephadex LH60 equilibrated in the same solvent. The column (2.0 cm \times 143 cm) was eluted at 10 ml/h and 4.5 ml fractions were collected. The eluate was monitored at 280 nm (\circ) and 50 μl samples were counted for radioactivity (\bullet). V8L and V8S were isolated by pooling as shown.

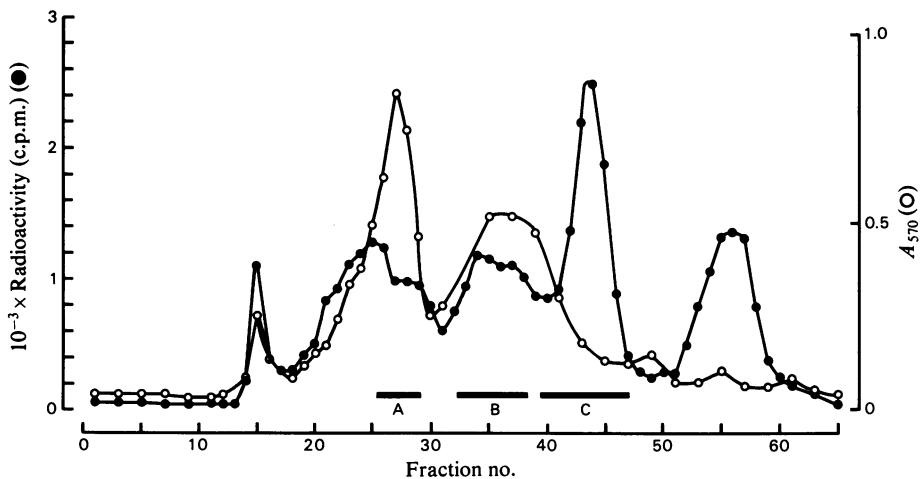

Fig. 5. CNBr cleavage of [^{125}I]DDISA-labelled V8S

Approx. 100 nmol of [^{125}I]DDISA V8S was cleaved with CNBr for 24 h at 25°C. Lyophilized peptides were dissolved in 5 ml of 90% formic acid/ethanol (3:7, v/v) and applied to a column of Sephadex LH60 (1.0 cm \times 165 cm), equilibrated in the same solvent. Peptides were eluted at 8 ml/h and 8.0 ml fractions were collected. Portions (0.8 ml) of the eluate were taken for protein determination by the manual ninhydrin method (\circ), and 1.0 ml samples were counted for radioactivity (\bullet). Fractions were pooled as shown.

Pool A contained a single peptide, V8S-I, identified by amino acid analysis and automated sequencing. This peptide was not significantly labelled with [^{125}I]DDISA or [^{14}C]succinic anhydride.

Pool B was rechromatographed on Sephadex LH20 in solvent A to yield pure peptide V8S-II labelled with both probes. Sequencing of [^{14}C -

succinyl-V8S-II by using the spinning cup gave specific radioactivities of 7.5 d.p.m./nmol for lysine-8 and, with reference to the whole peptide, 40.1 d.p.m./nmol for lysine 22 (Fig. 7).

Rechromatography of Pool C with Sephadex LH20 separated two radioactive peptides, V8S-III and V8S-IV. These peptides were coupled via homoserine lactone to AEAP-glass, and subjected

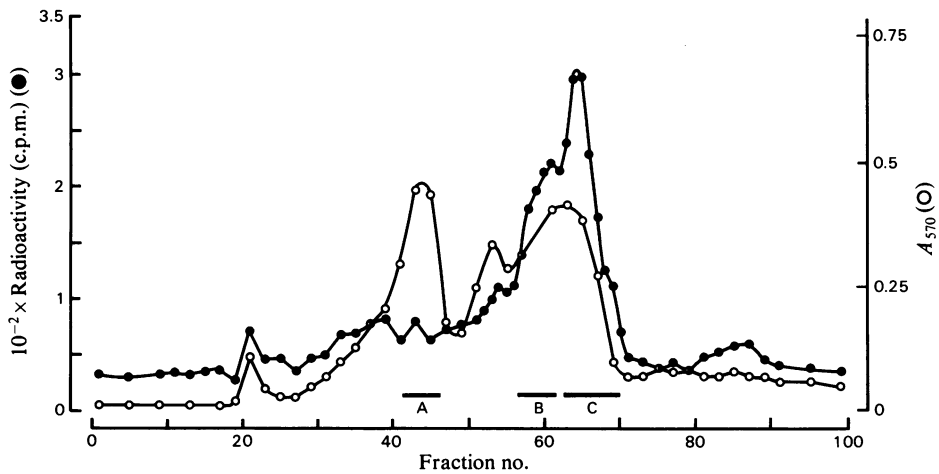
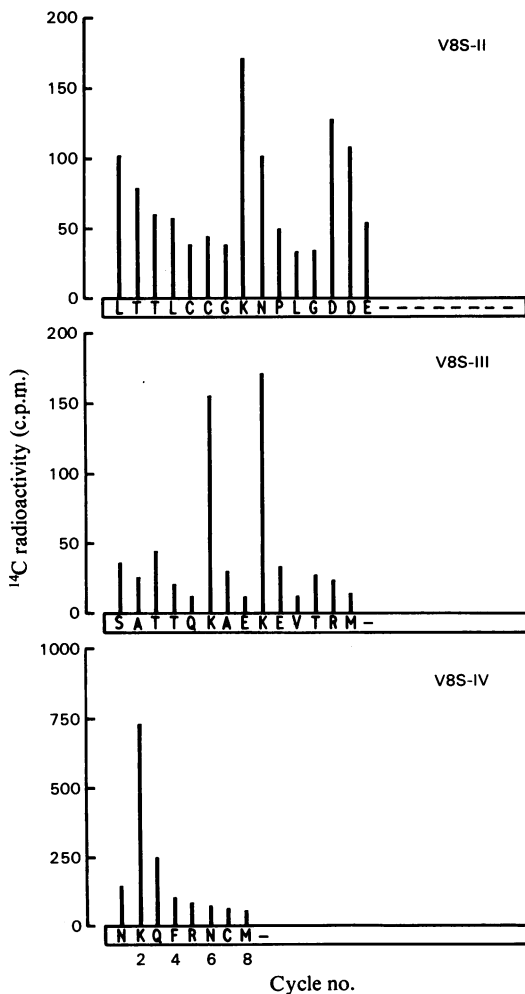

Fig. 6. CNBR cleavage of [^{14}C]succinyl-labelled V8S

[^{14}C]Succinyl-V8S (approx. 300nmol) was CNBr cleaved, lyophilized and dissolved in 5ml of 90% formic acid/ethanol (3:7, v/v). This was applied to a column of Sephadex LH60 (2.0 cm \times 159 cm), peptides were eluted at 10ml/h with the same solvent, and 5.0ml fractions were collected. Portions (200 μ l) of the eluate were taken for protein determination (○) and for counting for radioactivity. Fractions were pooled as shown.



to solid phase sequencing. ^{14}C radioactivity was released from [^{14}C]succinylated V8S-III at cycles 6 and 9, corresponding to the two lysine residues in the peptide, giving specific radioactivities of 36.4 and 55.9 d.p.m./nmol, respectively. The specific radioactivity of the single lysine residue in V8S-IV was 77.2 d.p.m./nmol (Fig. 7).

(ii) *V8L fragment*. ^{125}I -labelled and ^{14}C -labelled V8L was cleaved with CNBr, and chromatographed on Sephadex LH60 (Figs. 8 and 9). The [^{14}C]succinylated material in Pool A, eluting at the void volume, was subject to amino acid analysis and spinning cup sequencing and shown to be V8L-I. No radioactivity was recovered up to residue 30. It was not possible, therefore to obtain the specific radioactivity for the [^{14}C]succinyl-lysine at residue 55 directly from sequencing. However, its specific radioactivity (121.4 d.p.m./nmol) was inferred from that of the whole peptide, which is known to contain only one lysine residue (Fig. 10).

Pool B was treated with 20% formic acid, to separate peptides V8L-II and V8L-III. The insoluble

Fig. 7. Sequence of the [^{14}C]succinylated peptides from V8S

Sequenced residues identified at each cycle are given by the one-letter code [see *Biochem. J.* (1969) 113, 1-4]. V8S-II (36nmol, 1267 c.p.m.) was sequenced by the spinning cup method, giving a repetitive yield of 93%. V8S-III (9nmol, 565 c.p.m.) was sequenced by solid-phase methods, giving a repetitive yield of 91%. V8S-IV (16nmol, 867 c.p.m.) was sequenced by solid-phase methods, giving a repetitive yield of 90%. Counting efficiency was 70%.

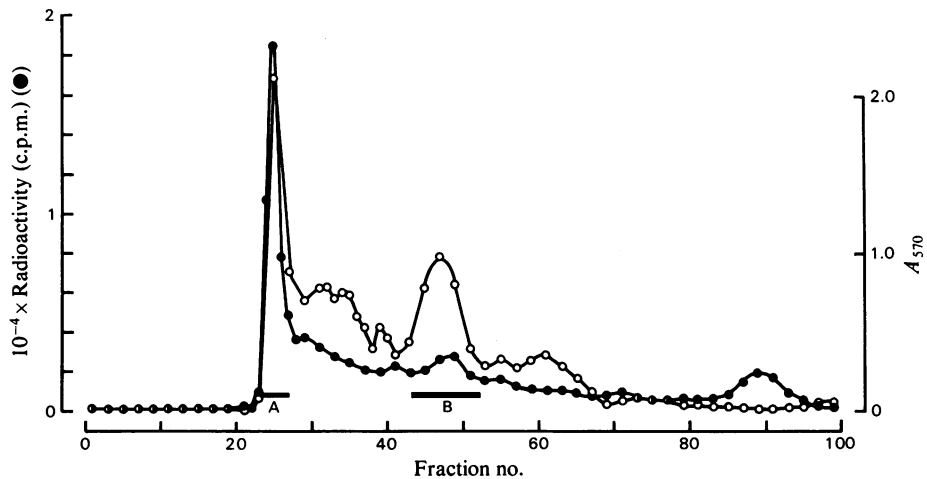

Fig. 8. *CNBr* cleavage of [^{125}I]DDISA-labelled V8L

Approx. 300 nmol of [^{125}I]DDISA-labelled V8L was *CNBr* cleaved, lyophilized and dissolved in 5 ml of 90% formic acid/ethanol (3:7, v/v). This was loaded on to a column of Sephadex LH60 (2.0 cm \times 159 cm) equilibrated in the same solvent. The column was eluted at 12 ml/h and 5.0 ml fractions were collected. Portions (0.5 ml) of the eluate were samples for protein determination (0.5 ml; \circ) radioactivity (1 ml; \bullet). Fractions were pooled as shown.

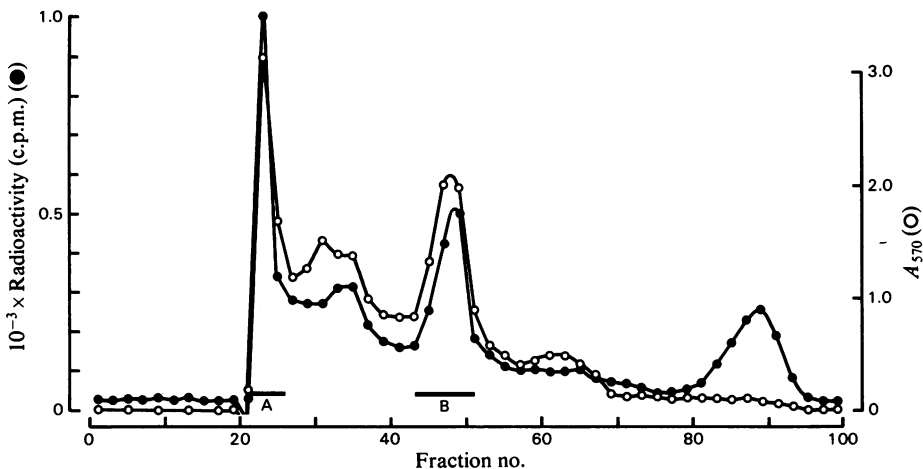

Fig. 9. *CNBr* cleavage of [^{14}C]succinyl-labelled V8L

[^{14}C]succinyl-V8L (approx. 500 nmol) was cleaved with *CNBr* for 24 h at 25°C. Lyophilized peptides were dissolved in 5 ml of 90% formic acid/ethanol (3:7, v/v) and applied to a column of Sephadex LH60. The column (2.0 cm \times 159 cm) were eluted at 10 ml/h with this solvent, and 4.8 ml fractions were collected. Portions of the eluate were taken for protein determination (200 μl ; \circ) by the manual ninhydrin method, and for counting for radioactivity (200 μl ; \bullet). Fractions were pooled as shown.

ble precipitate of V8L-II was found to carry both [^{125}I]DDISA and [^{14}C]succinyl label. [^{14}C]Succinyl V8L-II was coupled to AEAP-glass via homoserine lactone, and subject to solid-phase sequencing. The specific radioactivities of lysines 22 and 23 were found to be 16.8 and 57.1 d.p.m./nmol, respectively (Fig. 10).

The soluble peptide V8L-III was found to be the

N-terminal glycopeptide. It was not labelled to any significant extent by either reagent. If, however, the disc preparation was sonicated in the presence of DDISA, ^{125}I -labelled V8L-III could be isolated, demonstrating that lysine or tyrosine residues in this peptide were available for labelling if the membrane barrier was destroyed. Using a 10-fold molar excess of DDISA, for example, sonicated

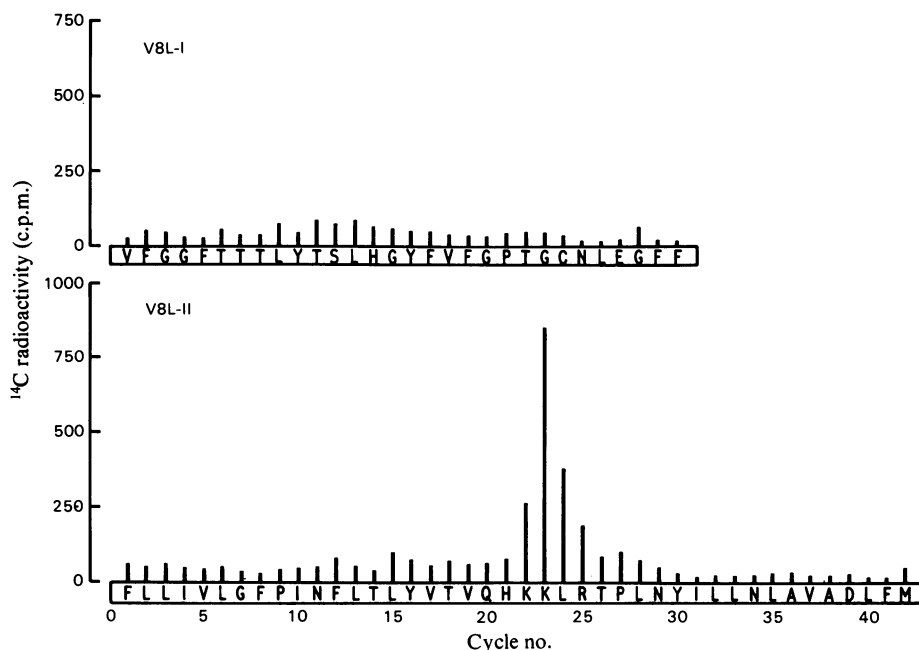

Fig. 10. Sequence of the [^{14}C]succinylated peptides from V8L

Sequenced residues identified at each cycle are given by the one-letter code. V8L-I (32 nmol, 2868 c.p.m.) was sequenced by using the spinning cup; repetitive yield was 95%. V8L-II (40 nmol, 2251 c.p.m.) was sequenced by using solid phase methods; repetitive yield was 95%. Counting efficiency was 72%.

Table 2. Specific activities of CNBr peptides

Membranes were modified with a 20-fold molar excess of DDISA or succinic anhydride, peptides were isolated by chromatography on Sephadex LH resins in 90% formic acid/ethanol (3:7, v/v), and identified by amino acid composition and sequence. Fractions of each peptide were taken for radioactive counting, and the amount of protein was estimated by amino acid analysis.

Peptide	Specific activity (mol of probe bound/mol of peptide)	
	[^{125}I]DDISA	[^{14}C]succinic anhydride
V8L-I	0.299	0.193
V8L-II	0.110	0.120
V8S-II	0.082	0.076
V8S-III	0.058	0.136
V8S-IV	0.228	0.116

membranes gave specific radioactivities of 0.037 and 0.029 mol of [^{125}I]DDISA/mol for V8L-II and V8L-III respectively.

The specific radioactivities of the CNBr peptides of V8S and V8L are presented in Table 2.

Discussion

Labelling studies with [^{125}I]DDISA and [^{14}C]succinic anhydride indicate that several regions of

the polypeptide chain of rhodopsin are available at the cytosolic surface of the photoreceptor disc membrane. Comparison of the labelling with [^{125}I]DDISA and [^{14}C]succinic anhydride gives good agreement as to which CNBr peptides are so exposed. The degree of labelling, however, differs between the two probes and this can be attributed to differences in their specificity and reactivity.

Neither [^{125}I]DDISA nor [^{14}C]succinic anhydride reacted with the intradiscally-located *N*-terminal glycopeptide V8L-III (please refer to Fig. 11), in spite of the presence of several potential reaction sites for the probes. This lack of interaction indicates that both reagents are membrane impermeable under the conditions employed. In contrast, peptides V8L-I, V8L-II, V8S-II, V8S-III and V8S-IV are all available for modification with both probes at the cytosolic surface of the disc membrane.

The fragment V8L-II is labelled with [^{14}C]succinic anhydride at Lys-66, and to a greater extent at Lys-67. His-65 and Tyr-74 are also candidates for modification by [^{125}I]DDISA. This labelled peptide, therefore, represents the first aqueous cytoplasmic loop, the peptide chain emerging from the bilayer before His-65 and re-entering possibly after Tyr-74.

V8L-I reacted with both [^{14}C]succinic anhydride and [^{125}I]DDISA. The only susceptible site

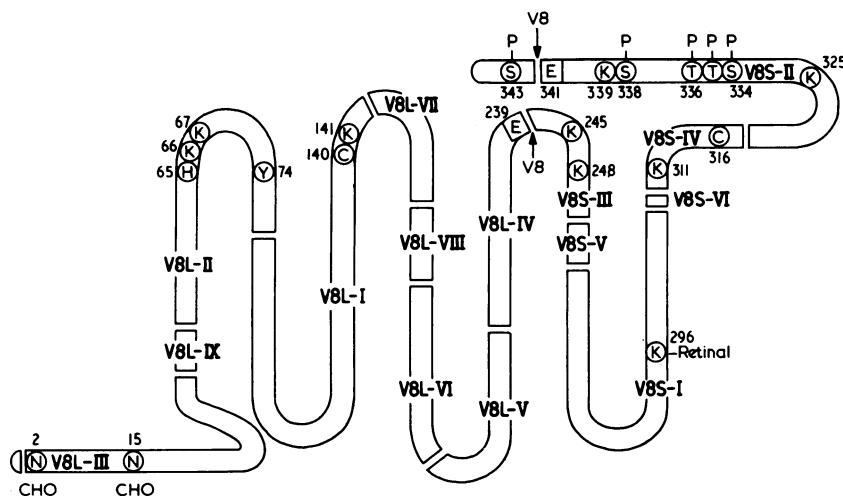

Fig. 11. Schematic model of ovine rhodopsin, showing those residues available for reaction with hydrophilic chemical probes at the cytosolic surface of the membrane

Individual CNBr peptides are represented as continuous line segments. The phosphorylation sites (P), carbohydrate attachment sites (CHO) and *S. aureus* V8 proteinase cleavage sites (V8) are also shown. Individual amino acid residues are indicated by the one-letter code.

for [^{14}C]succinic anhydride is Lys-141 although the possibility exists of reactive serine or threonine residues (Allen & Harris, 1976). The much higher incorporation of [^{125}I]DDISA into the peptide suggests the possibility that the reagent is also modifying either or both of Tyr-136 and Cys-140. This labelled peptide represents the second cytosolic membrane loop, which leaves the bilayer before Lys-141, possibly near Tyr-136. V8L-IV was not radioactive despite the presence of a potential site, His-152, for modification by [^{125}I]DDISA.

The third cytoplasmic loop is provided partly by V8L-IV, which contains the site of action of *S. aureus* V8 proteinase (Glu-239). It is interesting to note, however, that Lys-231 is not modified by either reagent to any significant extent. The remainder of this exposed proteinase-sensitive loop is provided by V8S-III, both of whose lysine residues react with succinic anhydride and DDISA.

V8S-IV contains a very reactive exposed thiol group, Cys-316, and this peptide can also be labelled by DDISA, and by succinic anhydride at Lys-311. One can hypothesize, therefore, that none of this peptide is located within the hydrophobic phase of the membrane.

Comparison of the specific radioactivities of the two lysines in V8S-II, modified with [^{14}C]succinic anhydride, indicates that the lysine at position 339 is much more heavily labelled than Lys-325. Lys-325 also has a lower specific radioactivity than Lys-310 in V8S-IV. The data suggest, therefore, that the lysine at position 325 in V8S-II is in a 'hidden' conformation or in an unusual environment, and

therefore less available for reaction. This is further supported by the observation that the two cysteines at positions 322 and 323 in V8S-II are not available for carboxymethylation in dark-adapted disc membranes (M. Brett & J. B. C. Findlay, unpublished work). The low level of radioactivity associated with lysine 325 may be due to the presence of a small amount of unregenerable (bleached) rhodopsin, in which this region of the protein becomes available for modification due to conformational changes which occur in bleaching.

Finally, it should be noted that peptides containing Tyr-10, Lys-16, Tyr-29, Tyr-30, Tyr-178, Cys-185, Cys-187, Tyr-191, Lys-195 and His-278 did not react with either reagent when sealed discs were used, although at least some of these were modified (V8L-III and V8S-I) when the discs were sonicated. As a result, it has been possible to speculate approximately where the polypeptide chain enters and leaves the environment of the lipid bilayer and to place some credence on the models proposed from structure prediction studies (Eliopoulos *et al.*, 1982; Hargrave *et al.*, 1983; Pappin *et al.*, 1984).

P. L. B. was in receipt of an SERC studentship. We are grateful to Mr. T. Thackrah for operation of the spinning cup sequencer and amino acid analyser. This research was supported by grants to J. B. C. F. from the SERC (grant BR/B/25315) and MRC (grant G979/352N).

References

- Allen, G. & Harris, J. I. (1976) *Eur. J. Biochem.* **62**, 601–612

- Booth, A. G. & Kenny, A. J. (1980) *Biochem. J.* **187**, 31–44
- Brett, M. & Findlay, J. B. C. (1979) *Biochem. J.* **177**, 215–233
- Brett, M. & Findlay, J. B. C. (1983) *Biochem. J.* **211**, 661–670
- Clark, S. P. & Molday, R. S. (1979) *Biochemistry* **18**, 5868–5873
- DeGrip, W. J. (1974) Ph.D. Thesis, University of Nijmegen
- Dratz, E. A., Miljanich, G. P., Nemes, P. P., Gaw, J. E. & Schwartz, S. (1979) *Photochem. Photobiol.* **29**, 661–670
- Edwards, R. M., Kempson, S. A., Carlson, G. L. & Dousa, T. P. (1979) *Biochim. Biophys. Acta* **553**, 54–65
- Eliopoulos, E., Geddes, A. J., Brett, M., Pappin, D. J. C. & Findlay, J. B. C. (1982) *Int. J. Biol. Macromol.* **4**, 263–268
- Findlay, J. B. C., Brett, M. & Pappin, D. J. C. (1981) *Nature (London)* **293**, 314–316
- Hargrave, P. A., Fong, S.-L., McDowell, J. H., Mas, M. T., Curtis, D. R., Wang, J. K., Juszczak, E. & Smith, D. P. (1980) *Neurochem. Int.* **1**, 231–244
- Hargrave, P. A., McDowell, J. H., Curtis, D. R., Wang, J. K., Juszczak, E., Fong, S.-L., Mohanna Rao, J. K. & Argos, P. (1983) *Biophys. Struct. Eng.* **9**, 235–240
- Helmkamp, R. W. & Sears, D. A. (1970) *Int. J. Appl. Radiat. Isotop.* **21**, 683–685
- Laemmli, U. K. (1970) *Nature (London)* **277**, 680–685
- Law, P. Y., Ostwald, T. J., Way, E. L. & Loh, H. H., (1981) *Mol. Pharmacol.* **19**, 355–366
- Mas, M. T., Wang, J. K. & Hargrave, P. A. (1980) *Biochemistry* **19**, 684–692
- Ovchinnikov, Yu. A. (1982) *FEBS Lett.* **148**, 179–191
- Pappin, D. J. C. & Findlay, J. B. C. (1984) *Biochem. J.* **217**, 605–613
- Pappin, D. J. C., Eliopoulos, E., Geddes, A. J. & Findlay, J. B. C. (1984) *Int. J. Biol. Macromol.*, in the press
- Pober, J. S., Iwanij, V., Reich, E. & Stryer, L. (1978) *Biochemistry* **17**, 2163–2169
- Raubach, R. A., Nemes, P. P. & Dratz, E. A. (1974) *Exp. Eye Res.* **18**, 1–12
- Rohlich, P. (1976) *Nature (London)* **263**, 789–791
- Saari, J. C. (1974) *J. Cell. Biol.* **63**, 480–491
- Sale, G. J., Towner, P. & Akhtar, M. (1977) *Biochemistry* **16**, 5641–5649
- Sale, G. J., Towner, P. & Akhtar, M. (1978) *Biochem. J.* **175**, 421–430
- Spiva, D. A. & Sears, D. A. (1981) *J. Reticuloendothelial Soc.* **30**, 129–145
- Tam, S. W., Fenton, J. W. & Detwiler, T. C. (1980) *J. Biol. Chem.* **255**, 6626–6632
- Yu, B. P., Masoro, E. J. & Morley, T. F. (1976) *J. Biol. Chem.* **251**, 2037–2043