

Spectrophotometric Studies of Acyl-Coenzyme A Synthetases of Rat Liver Mitochondria

By P. B. GARLAND,* D. W. YATES AND B. A. HADDOCK
Department of Biochemistry, University of Bristol, Bristol BS8 1TD, U.K.

(Received 20 April 1970)

1. Deca-2,4,6,8-tetraenoic acid is a substrate for both ATP-specific (EC 6.2.1.2 or 3) and GTP-specific (EC 6.2.1.-) acyl-CoA synthetases of rat liver mitochondria. The enzymic synthesis of decatetraenoyl-CoA results in new spectral characteristics. The difference spectrum for the acyl-CoA minus free acid has a maximum at 376nm with ϵ_{max} 34. Isosbestic points are at 345nm and 440nm. 2. The acylation of CoA by decatetraenoate in mitochondrial suspensions can be continuously measured with a dual-wavelength spectrophotometer. 3. By using this technique, three distinct types of acyl-CoA synthetase activity were demonstrated in rat liver mitochondria. One of these utilized added CoA and ATP, required added Mg^{2+} and corresponded to a previously described 'external' acyl-CoA synthetase. The other two acyl-CoA synthetase activities utilized intramitochondrial CoA and did not require added Mg^{2+} . Of these two 'internal' acyl-CoA synthetases, one was insensitive to uncoupling agents, was inhibited by phosphate or arsenate, and corresponded to the GTP-specific enzyme. The other corresponded to the ATP-specific enzyme. 4. Atractylate inhibited the activity of the two internal acyl-CoA synthetases only when the energy source was added ATP. 5. The amount of intramitochondrial CoA acylated by decatetraenoate was independent of whether the internal ATP-specific or GTP-specific acyl-CoA synthetase was active. It is concluded that these two internal acyl-CoA synthetases have access to the same intramitochondrial pool of CoA. 6. The amount of intramitochondrial CoA that could be acylated with decatetraenoate was decreased by the addition of palmitoyl-DL-carnitine, 2-oxoglutarate, or pyruvate. These observations indicated that pyruvate dehydrogenase (EC 1.2.4.1), oxoglutarate dehydrogenase (EC 1.2.4.2), carnitine palmitoyltransferase (EC 2.3.1.-), citrate synthase (EC 4.1.3.7), and succinyl-CoA synthetase (EC 6.2.1.4) all have access to the same intramitochondrial pool of CoA as do the two internal acyl-CoA synthetases.

A number of schemes have been proposed in attempts to understand the manner in which acyl-CoA synthesis activities are arranged in mitochondria (Fritz, 1963; Rossi, Galzigna, Alexandre & Gibson, 1967; van den Bergh, 1967; Garland & Yates, 1967; Bremer, Norum & Farstad, 1967). All of these schemes involve permeability barriers and compartments, and such features require to be studied in mitochondria that are undamaged [i.e. intact mitochondria; criteria for intactness are described elsewhere (Nicholls & Garland, 1969)]. To facilitate the direct study of mitochondrial acyl-CoA synthetases we have investigated the use of deca-2,4,6,8-tetraenoic acid as a chromophoric substrate. Fatty acids with one or more double bonds conjugated with the carboxyl group have

characteristic absorption spectra with maxima in the u.v. These maxima occur at higher wavelengths when a thiol ester is formed. For instance, the anions of crotonic (but-2-enoic) acid and sorbic (hexa-2,4-dienoic) acid have absorption maxima at 205nm and 250nm respectively, whereas their thiol esters have maxima at 263nm and 296nm (Jaenicke & Lynen, 1960; Wakil & Hübscher, 1960). These wavelengths occur in a region where considerable technical difficulties arise in the application of spectrophotometric techniques to suspensions of mitochondria (Chance, 1961). It was anticipated that fatty acids with three or four double bonds conjugated with the carboxyl group would have more favourable optical properties. In this paper we describe the spectral properties of deca-2,4,6,8-tetraenoic acid and its coenzyme A thiol ester, and the exploitation of these properties in a study of

* Present address: Department of Biochemistry, University of Dundee, Dundee DD1 4HN, U.K.

mitochondrial acyl-CoA synthetases. Preliminary reports have been published (Yates & Garland, 1967; Garland, Haddock & Yates, 1969).

MATERIALS

Mitochondria were prepared from the livers of male or female Wistar rats as described previously (Garland, Shepherd & Yates, 1965). The acyl-CoA synthetase specific for ATP and medium-chain-length fatty acids (EC 6.2.1.2) was prepared from an acetone-dried powder of ox liver mitochondria by the procedure of Mahler, Wakil & Bock (1953) modified to include further purification by chromatography on a column of diethylaminoethylcellulose. Decatetraenoic acid was purchased from K & K Laboratories, Plainview, N.Y., U.S.A., and examined for purity by t.l.c. on silicic acid with a solvent system of light petroleum (b.p. 40–60°C)–diethyl ether–methanol (90:20:2, by vol.). Examination of the developed t.l.c. plate under u.v. light revealed only one compound, which ran closely behind the solvent front. This result was consistent with the suppliers' claim that their decatetraenoic acid was at least 95% pure. The decatetraenoic acid obtained from another source was found to be highly impure when similarly examined by t.l.c. Decatetraenoic acid appeared to be unstable on storage; the absorption spectrum of a 10 mM solution in methanol kept at 0°C changed slowly, the extinction at 323 nm declining by about 5% per day. Methanolic solutions of decatetraenoic acid (10 mM) were therefore prepared freshly as required. CoA, ATP, pyruvic acid and 2-oxoglutaric acid were obtained from C. F. Boehringer und Soehne G.m.b.H., Mannheim, Germany, oligomycin and tris base from Sigma Chemical Co., St Louis, Mo., U.S.A., and DL-carnitine from Koch–Light Laboratories Ltd., Colnbrook, Bucks., U.K. All other reagents used were of analytical grade where possible. Octa-2,4,6-trienoic acid was purchased from the Aldrich Chemical Co Inc., Milwaukee, Wis., U.S.A. *p*-Trifluoromethoxycarbonyl cyanide phenylhydrazone (Heytler, 1963) and lewisite oxide were kindly given by Professor J. B. Chappell, and atractylate was obtained from Dr S. Luciani.

METHODS

CoA was assayed as described by Garland *et al.* (1965). Mitochondrial incubations were made in an initially air-saturated medium at 25°C containing KCl (80 mM), tris-chloride buffer, pH 7.2 (20 mM), and EDTA (1 mM). Other additions were as described below. Absorption spectra of decatetraenoic and octatrienoic acids and of their enzymically-synthesized thiol esters were measured with a Unicam SP. 800 spectrophotometer. Absorption spectra of mitochondrial suspensions were measured with a split-beam scanning spectrophotometer that originates from the design of Yang (1954). Our apparatus used a 100W tungsten-filament lamp with a quartz jacket containing I₂ vapour, and a Hilger and Watts Monospek 600 monochromator giving a reciprocal dispersion of 13.6 nm cm⁻¹. In the experiments described here the following operating conditions were used: width of entrance and exit slits, 1 mm; optical path of cuvettes, 1 cm; chopping frequency between cuvettes, 1 kHz; scanning speed, 2–5 nm s⁻¹. The kinetics of decatetraenoyl-CoA formation by mito-

chondrial suspensions were measured with a dual-wavelength spectrophotometer (Chance & Legallais, 1951) that utilized a 100W tungsten lamp (see above), two Hilger and Watts D275 monochromators (quartz prisms), a chopping frequency of 70 Hz, and slit widths corresponding to a spectral band width of 2 nm at the wavelength pair used, which was 376–412 nm. The cuvette had an optical path of 1 cm. In all dual-wavelength spectrophotometric recordings reproduced in the figures, an upward deflexion corresponds to an increase in extinction at 376 nm over any change at 412 nm.

To study acyl-CoA synthetases in submitochondrial fractions, the mitochondria were treated in the following manner. First 120 mg of mitochondrial protein was diluted with incubation medium into a final volume of 6.0 ml, and exposed in 3.0 ml samples to the full output of an MSE 60W ultrasonic disintegrator (Measuring and Scientific Equipment Ltd., London S.W.1, U.K.) for a total of 1 min. The suspension of disintegrated mitochondria was then centrifuged in the 8 × 10 ml head of an MSE50 centrifuge for 2 h at 40 000 rev./min (105 000g). The mitochondrial supernatant (soluble fraction) was removed and the pellet (membrane fraction) was suspended in incubation medium at 0°C. Decatetraenoyl-CoA synthesis by these fractions was studied with the dual-wavelength spectrophotometer at a wavelength pair of 376–420 nm, where $\epsilon_{m\mu}$ (thiol ester minus acid) is 27. The conditions for the assays are described in the legends of the appropriate figures. Palmitoyl-CoA synthetase activity was assayed by the procedure of Yates, Shepherd & Garland (1966) which measures the conversion of CoA into its acid-insoluble form, palmitoyl-CoA.

RESULTS

Spectra of decatetraenoic acid, octatrienoic acid and their thiol esters with CoA. The spectra of these two acids in aqueous solution at pH 7.2 are shown in Figs. 1 and 2. Octatrienoate has a maximum extinction at 292 nm, whereas that for decatetraenoate is at 323 nm. Acid–CoA ligase (AMP) from ox liver catalyses the following reaction:

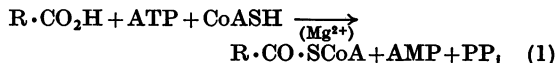

To determine whether octatrienoate or decatetraenoate were substrates for this reaction, the spectra in Figs. 1 and 2 were redetermined after addition of the appropriate substrates (reaction 1) and Mg²⁺ to the cuvettes. No change was observed until acyl-CoA synthetase was added, when the original absorption maximum diminished and was replaced by another at a higher wavelength: 343 nm for octatrienoate, 376 nm for decatetraenoate. Repetitive wavelength scans were made until the change was complete, which took about 20 min under the conditions of Figs. 1 and 2. In these experiments the extinction change was limited by the amount of fatty acid, and the reaction could be restarted after completion only by the addition of further

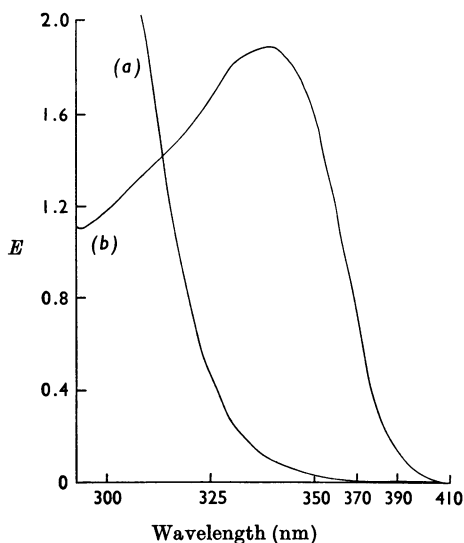

Fig. 1. Spectra of octatrienoic acid and octatrienoyl-CoA. Recordings were made with a Unicam SP.800 spectrophotometer, with cuvettes of 1 cm light-path. The wavelength scale is expanded twofold below 350nm. Both cuvettes contained 200 μ mol of tris-chloride buffer, pH 8.5, 2 μ mol of $MgCl_2$, 2 μ mol of ATP and 0.2 unit of acid-CoA ligase (AMP) (EC 6.2.1.2, prepared from ox liver) in a final volume of 2.0ml at 25°C. Then 0.16 μ mol of Octa-2,3,6-trienoic acid was added to the test cuvette and spectrum (a) was recorded. CoA (0.5 μ mol) was added to the test cuvette, and repetitive scans were made until no further change was detected (20 min) when spectrum (b) was recorded.

fatty acid; more enzyme, Mg^{2+} , ATP or CoA were without effect. These spectral changes were dependent on the presence of CoA, ATP, fatty acid and Mg^{2+} as well as enzyme, and were not observed if any of these was omitted. From these observations it is concluded that octatrienoate and decatetraenoate are substrates for the medium-chain-length specific ATP-specific acyl-CoA synthetase. Under the conditions used the acylation of CoA was apparently complete if all other substrates were in excess, as was to be expected from the studies of Wakil & Hübscher (1960) and Tubbs & Garland (1964). From the results of Figs. 1 and 2, the ϵ_{mM} (thiolester minus acid) for octatrienoyl-CoA (343nm) and decatetraenoyl-CoA (376nm) were calculated to be 24 and 27 respectively. When CoA was the limiting substrate ϵ_{mM} at 376nm was observed to be 34 for decatetraenoyl-CoA minus decatetraenoate. This value is higher than that observed when decatetraenoate was limiting, and is probably due to the fact that the completion of the reaction was

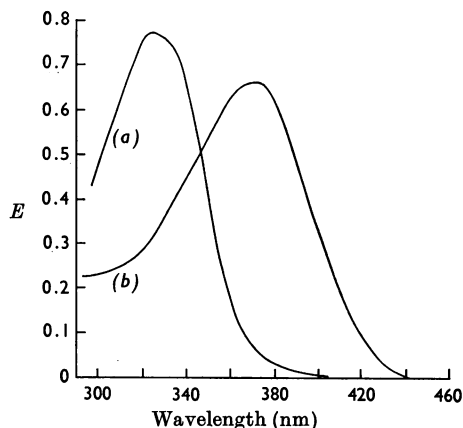

Fig. 2. Spectra of decatetraenoic acid and decatetraenoyl-CoA. Recordings were made with a Beckman DB spectrophotometer with cuvettes of 1 cm light-path. Both cuvettes contained 200 μ mol of tris-chloride buffer, pH 7.5, 2 μ mol of $MgCl_2$, 2 μ mol of ATP and 0.2 unit of acid-CoA ligase in a final volume of 2.0ml at 25°C. Then 50 nmol of deca-2,4,6,8-tetraenoic acid was added to the test cuvette, and spectrum (a) was recorded. CoA (0.5 μ mol) was then added to the test cuvette, and repetitive scans were made until no further change was detected (30 min), when spectrum (b) was recorded.

more sharply defined when CoA was limiting, and therefore not measured prematurely.

Fig. 3 shows the difference spectrum for decatetraenoyl-CoA minus decatetraenoate. There is an isosbestic point at 345nm and a trough at 320nm.

Spectra of intramitochondrial decatetraenoyl-CoA. The successful application of a chromophoric substrate for studies of acyl-CoA formation in mitochondria clearly depends upon the avoidance of spectroscopic changes due to other events, such as the reduction of NAD (340nm) or cytochrome *b* (429nm). Decatetraenoic acid was preferable to octatrienoic acid for obtaining spectroscopic specificity, since the absorption maximum of decatetraenoyl-CoA is at a point (376nm) where oxidation-reduction changes in rat liver mitochondria cause minimal changes in extinction (Chance & Williams, 1956). By contrast, the absorption maximum for octatrienoyl-CoA is at 343nm and nearly coincides with that of NADH and NADPH.

Spectroscopic studies of light-scattering suspensions require measurement not only at the wavelength of interest but also at a nearby reference wavelength to compensate for changes in light-scattering (Chance & Legallais, 1951). In these studies we have used a wavelength pair of 376 and 412nm and ϵ_{mM} 24 for decatetraenoyl-CoA minus decatetraenoate.

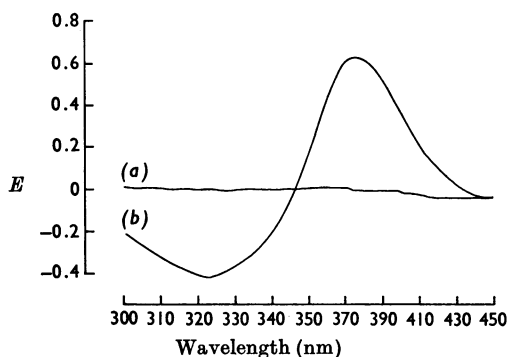
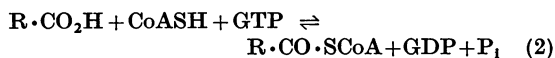

Fig. 3. Difference spectrum for decatraenoyl-CoA minus decatetraenoate. Recordings were made with a Unicam SP.800 spectrophotometer with cuvettes of 1 cm light-path. The wavelength scale is expanded twofold below 350 nm. Both cuvettes contained 200 μ mol of tris-chloride buffer, pH 8.5, 2 μ mol of $MgCl_2$, 2 μ mol of ATP, 0.2 μ mol of deca-2,4,6,8-tetraenoic acid and 0.2 unit of acid-CoA ligase in a final volume of 2.0 ml. The base-line (a) was recorded, and 20 nmol of CoA was added to the test cuvette. Spectrum (b) was recorded 20 min later when no further changes were occurring.

Interference could occur from sufficiently large changes in the oxidoreduction state of respiratory carriers, but in the experiments described no such changes occurred. However, further evidence for the validity of dual-wavelength spectrophotometric measurements of the transition between steady states comes from difference spectra. In the experiment of Fig. 4, the intramitochondrial content of nucleoside triphosphate was depleted by preincubation of the mitochondria with an uncoupling agent trifluoromethoxycarbonyl cyanide phenylhydrazine and also arsenate (Heldt, Jacobs & Klingenberg, 1964). Decatetraenoate and oligomycin were then added to the mitochondria and synthesis of decatetraenoyl-CoA did not occur (see below) until ATP was added to the test cuvette. The resultant difference spectrum (plus ATP versus minus ATP) is that for decatetraenoyl-CoA minus decatetraenoate.

The kinetics of decatetraenoyl-CoA synthesis by rat liver mitochondria. (a) Synthesis in the presence of uncoupling agents. A GTP-specific acyl-CoA synthetase has been isolated from ox liver by Rossi & Gibson (1964), and catalyses the reversible reaction (2).



The enzyme is inhibited by P_1 and catalyses an arsenolysis of acyl-CoA. Evidence for the presence of this enzyme in rat liver mitochondria has been described by van den Bergh (1965), who concluded

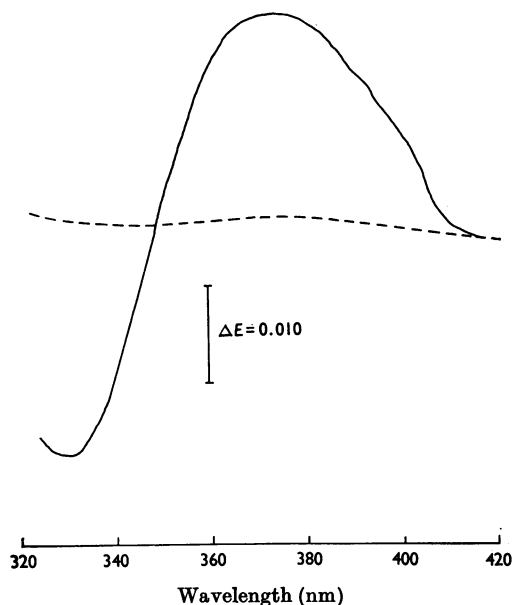

Fig. 4. Difference spectrum for decatetraenoyl-CoA synthesized by mitochondria. Stock mitochondrial suspension (0.2 ml; 60 mg of protein/ml of 0.25 M-sucrose) was mixed with 5.0 ml of incubation medium containing 4 nmol of trifluoromethoxycarbonyl cyanide phenylhydrazine and 20 μ mol of sodium arsenate, pH 7.2, and left at 25°C for 3 min when 5 μ g of oligomycin and 50 nmol of decatetraenoic acid were added. The mixture was divided equally between the test and reference cuvettes of a scanning spectrophotometer, and the base-line (----) was recorded. ATP (2 μ mol) was then added to the test cuvette, and after 2 min the spectrum shown was recorded. An upward deflexion corresponds to an increase in the extinction of the test cuvette over the reference cuvette.

that the oxidation of endogenous 2-oxoglutarate could provide sufficient GTP for reaction (2) despite the presence of an uncoupling agent such as 2,4-dinitrophenol. Fig. 5 shows experiments demonstrating a mitochondrial decatetraenoyl-CoA synthetase activity with the characteristics of the GTP-specific enzyme, namely insensitivity to uncoupling agents, inhibition by phosphate, inhibition [and deacylation (Fig. 6)] with arsenate. The likely involvement of endogenous oxoglutarate oxidation is demonstrated by the inhibitory effect of lewisite oxide. Atractylate (20 μ M) did not inhibit the synthesis of decatetraenoyl-CoA under these conditions, nor did 10 mM-potassium fluoride.

(b) Synthesis dependent on added ATP. Demonstration of an ATP requirement could be most clearly demonstrated when the GTP-specific enzyme was first inhibited with arsenate or phosphate.

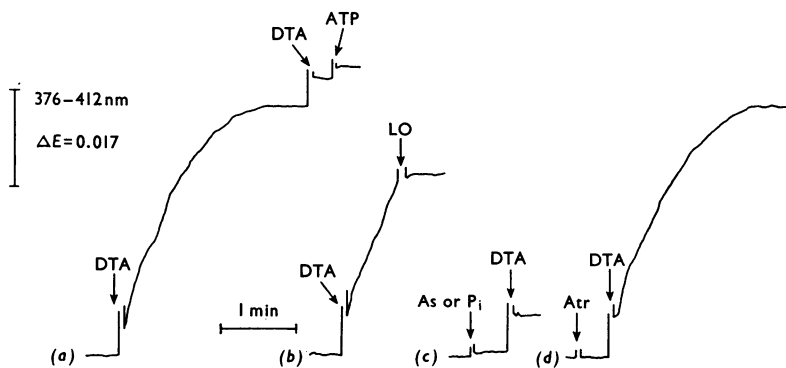

Fig. 5. Inhibition of mitochondrial decatetraenoyl-CoA synthesis by arsenate and phosphate dual-wavelength spectrophotometric recordings. In each experiment 4 mg of mitochondrial protein was mixed with 2.0 ml of incubation medium containing 10 nmol of pentachlorophenol. After 2 min 10 μ g of oligomycin was added, and after a further 1 min, 20 nmol of decatetraenoic acid (DTA). Further additions were: experiment (a), another 20 nmol of DTA and 4 μ mol of ATP; experiment (b), 0.3 mg of lewisite oxide (LO); experiment (c), 4 μ mol of potassium phosphate (P_i), pH 7.2, or potassium arsenate (As), pH 7.2; experiment (d), 40 nmol of atractylate (Atr).

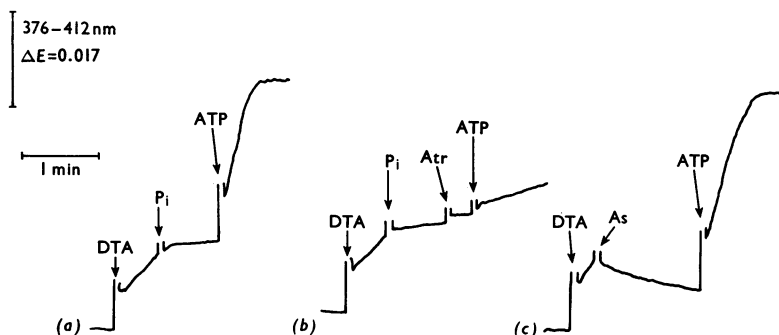

Fig. 6. ATP-dependent decatetraenoyl-CoA synthesis by mitochondria; dual-wavelength spectrophotometric recordings. In each experiment 4 mg of mitochondrial protein was mixed with 2.0 ml of incubation medium containing 10 nmol of pentachlorophenol. After 2 min 10 μ g of oligomycin was added, and after another 1 min, 20 nmol of decatetraenoic acid (DTA). Other additions were: experiment (a), 4 μ mol of potassium phosphate (P_i), pH 7.2, and 4 μ mol of ATP; experiment (b), 4 μ mol of potassium phosphate (P_i), pH 7.2, 40 nmol of atractylate (Atr) and 4 μ mol of ATP; experiment (c), 4 μ mol of potassium arsenate (As), pH 7.2, and 4 μ mol of ATP.

The addition of ATP resulted in decatetraenoyl-CoA synthesis. Atractylate was inhibitory (Fig. 6).

(c) Synthesis dependent on added CoA. When decatetraenoyl-CoA synthesis from intramitochondrial CoA was completed, the addition of CoA resulted in a further, extensive reaction (Fig. 7). The synthesis of decatetraenoyl-CoA from added CoA and ATP required the addition of Mg^{2+} but was insensitive to atractylate (20 μ M).

Thus so far three distinct decatetraenoyl-CoA synthetase activities have been characterized, and their properties are summarized in Table 1. For reasons discussed below, the activities are referred

to as (1) internal GTP-dependent, (2) internal ATP-dependent, and (3) external ATP-dependent, where 'internal' and 'external' refer to the permeability barrier that separates intramitochondrial nucleotides from added (extramitochondrial) nucleotides.

(d) The extent of acylation of intramitochondrial CoA by decatetraenoate. Rat liver mitochondria contain approximately 2 nmol of CoA/mg of protein. Garland *et al.* (1965) showed that most of this CoA could be acylated by the addition of palmitoyl-DL-carnitine, but that acylation was less extensive if palmitate and ATP were the acylating

agents. The maximum amount of intramitochondrial CoA acylated by decatetraenoate in experiments such as those shown in Figs. 5 and 6

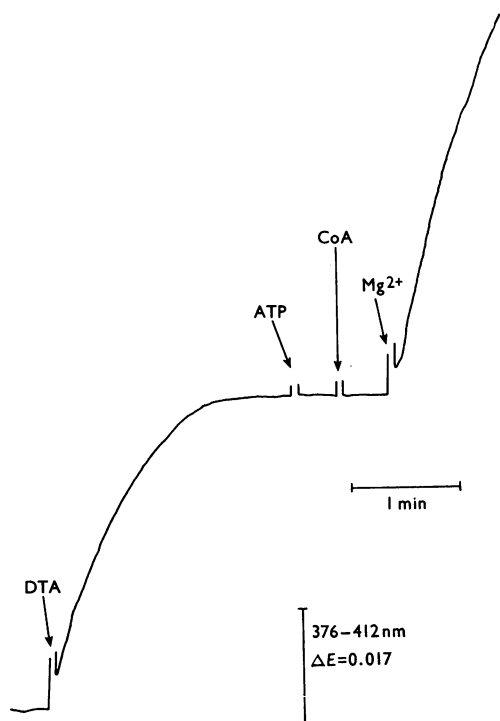

Fig. 7. Synthesis of decatetraenoyl-CoA from added CoA by mitochondria; dual-wavelength spectrophotometric recordings. Mitochondrial protein (4 mg) was mixed with 2.0 ml of incubation medium containing 10 nmol of pentachlorophenol. After 2 min 10 μ g of oligomycin was added, and after a further 1 min, 20 nmol of decatetraenoic acid (DTA). Further additions were 4 μ mol of ATP, 20 nmol of CoA and 4 μ mol of $MgCl_2$.

was about 1 nmol/mg when calculated from the extinction change. A comparison between the changes of acylation of intramitochondrial CoA as measured by direct assay of CoA (Garland *et al.* 1965) or by the extinction of decatetraenoyl-CoA was made in the experiment shown in Fig. 8. It is seen that there was excellent agreement between the changes in CoA measured directly and the changes in decatetraenoyl-CoA measured indirectly. The small excess of CoA change over decatetraenoyl-CoA change may be due to the utilization of endogenous fatty acids. Only 50% of the intramitochondrial CoA became acylated in this experiment. In view of the reversibility of reactions (1) and (2), it seems unfounded to allocate the unacylated CoA to a separate compartment as we previously proposed (Garland *et al.* 1965).

(e) Acylation of intramitochondrial CoA by GTP- and ATP-specific enzymes. The experiments in Figs. 5 and 6 show that within a single preparation of mitochondria the amount of intramitochondrial CoA that can be acylated by decatetraenoate is independent of whether the internal GTP-specific or ATP-specific enzyme is active. The simplest explanation is that the two enzymes occur in the same mitochondria and that they have access to a common pool of CoA.

(f) Deacylation of intramitochondrial decatetraenoyl-CoA. Previously synthesized intramitochondrial decatetraenoyl-CoA could possibly become deacylated by four mechanisms: (1) hydrolysis by a deacylase (EC 3.1.2.2); (2) arsenolysis via the GTP-dependent acyl-CoA synthetase; (3) acyl transfer to carnitine; and (4) reversal of either of the two acyl-CoA synthetases (reactions 1 and 2). Deacylation by an active hydrolase could be anticipated if the intramitochondrial acyl-CoA synthetases were inhibited after decatetraenoyl-CoA synthesis had occurred, as in the experiment in Fig. 9, where atractylate was added after ATP. In

Table 1. *Properties of decatetraenoyl-CoA synthetase activities of intact mitochondria from rat liver*

Abbreviation: FCCP, *p*-trifluoromethoxycarbonyl cyanide phenylhydrazine.

	Decatetraenoyl-CoA synthetase		
	Internal		External
Presumed nucleotide specificity	ATP	GTP	ATP
Requirement for added Mg^{2+}	None	None	Absolute
Requirement for added CoA	None	None	Absolute
CoA acylated	Endogenous	Endogenous	Exogenous
Response to arsenate or phosphate	None	Inhibited	None
Requirement for ATP after treatment with FCCP and arsenate	Required	—	Required
Effect of atractylate on activity dependent on added ATP	Inhibitory	—	Non-inhibitory

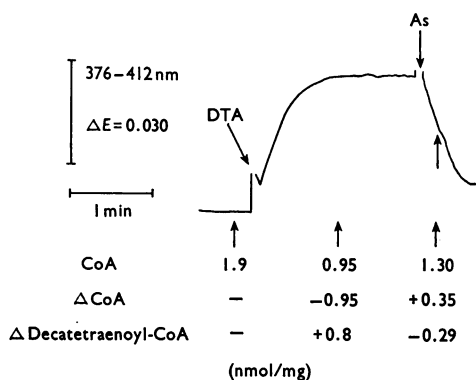

Fig. 8. Comparison of decatetraenoyl-CoA synthesis and CoA disappearance. An experiment was first made with the dual-wavelength spectrophotometer, and the result is shown in the recorder tracing. Mitochondrial protein (4mg) in 2.0ml of incubation medium containing 10nmol of pentachlorophenol was incubated for 2min before the addition of 20nmol of decatetraenoic acid (DTA). Then 4 μ mol of sodium arsenate (As), pH7.2, was added. Repeats of the start of the experiment were made and terminated at moments indicated by the arrows below the spectrophotometer tracing. Termination was effected by transfer of the contents of the cuvette to 2.0ml of ice-cold 10% (w/v) HClO₄. The HClO₄ extract was assayed enzymically for CoA as described by Garland *et al.* (1965). The values underneath the termination arrows are the mitochondrial contents of CoA (as determined by enzymic analysis) and the changes (Δ values) in the content of CoA and decatetraenoyl-CoA, the latter being calculated from the dual-wavelength recording.

fact deacylation was not observed. Deacylation after the addition of arsenate is clearly demonstrated in the experiment in Fig. 8. Deacylation after the addition of carnitine is demonstrated by the experiment in Fig. 9 and can be attributed to the activity of carnitine palmitoyltransferase (EC 2.3.1.-), which has a relatively broad chain-length specificity.

Reversal of decatetraenoyl-CoA synthesis would be expected if one of the substrates of reactions 1 and 2 were removed after the reaction had proceeded. CoA is one substrate that can be removed by conversion into acetyl-CoA or succinyl-CoA, and Fig. 10 shows an experiment in which decatetraenoyl-CoA was deacylated after the addition of pyruvate and then resynthesized after the addition of ATP. This effect of ATP can be attributed to its involvement in reaction 1. It is unlikely that this effect of pyruvate was due to displacement of decatetraenoate by an anion exchange from the intramitochondrial space, since a similar concentration of L-malate was without effect. Further, this effect of pyruvate was abolished by the presence of 0.5mM-sodium

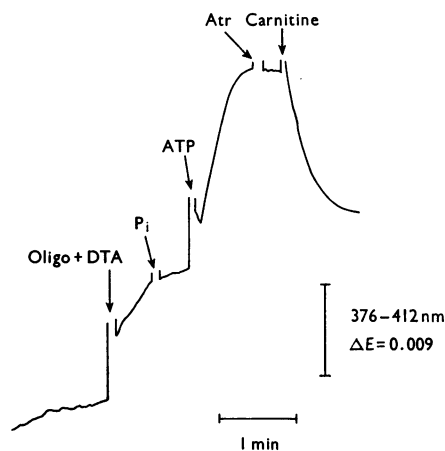

Fig. 9. Deacylation of intramitochondrial decatetraenoyl-CoA by DL-carnitine, dual-wavelength measurements at 376 and 412nm. Mitochondrial protein (6 mg) was incubated for 2min in 2.0ml of incubation medium containing 10nmol of pentachlorophenol. Further additions then made were 10 μ g of oligomycin with 20nmol of decatetraenoic acid (Oligo+DTA), 4 μ mol of potassium phosphate, pH7.2 (P_i), 4 μ mol of ATP, 40nmol of atractylate (Atr) and 0.5 μ mol of DL-carnitine.

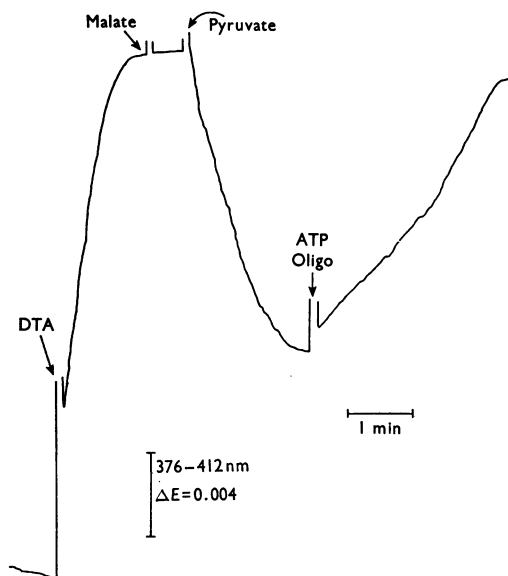

Fig. 10. Deacylation of decatetraenoyl-CoA; dual-wavelength spectrophotometer recordings. Mitochondrial protein (4 mg) was mixed with 2.0ml of incubation medium containing 10nmol of pentachlorophenol. After 2min 20nmol of decatetraenoic acid (DTA) was added, followed by L-malate (4 μ mol), sodium pyruvate (4 μ mol), oligomycin (Oligo) (10 μ g) and ATP (4 μ mol).

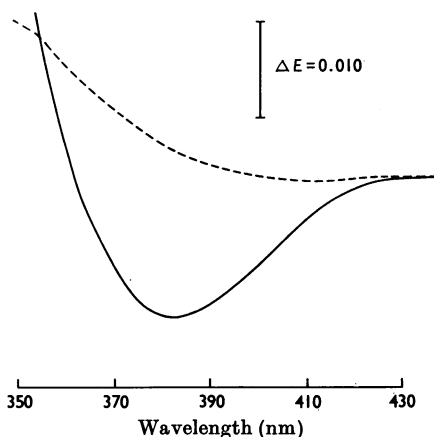

Fig. 11. Deacylation of intramitochondrial decatetraenoyl-CoA by the addition of pyruvate. Stock mitochondrial suspension (0.2 ml; 60 mg/ml of 0.25 M-sucrose) was mixed with 5.0 ml of incubation medium containing 25 nmol of pentachlorophenol and 50 nmol of decatetraenoate, and left at 25°C for 2 min. The mixture was then divided equally between the test and reference cuvettes of a scanning spectrophotometer, and the base-line (----) was recorded. Then 5 μ mol of sodium pyruvate (pH 7.2) was added to the test cuvette, and after 2 min the spectrum shown (—) was recorded. An upward deflexion corresponds to an increase in the extinction of the test cuvette over the reference cuvette.

arsenite. 2-Oxoglutarate (2 mM) behaved in a manner similar to pyruvate, except that the extent of deacylation was greater. These spectroscopic observations do not reflect concomitant changes in the oxidation-reduction state of respiratory carriers; the split-beam spectrophotometric recording shown in Fig. 11 demonstrates the appearance of a trough at 376 nm when pyruvate caused deacylation of decatetraenoyl-CoA. The higher wavelength (356 nm) for the isobestic point in this spectrum is probably due to an increase in extinction at the lower wavelength due to pyruvate itself and some reduction of NAD and NADP. The behaviour of 2-oxoglutarate was again similar to that of pyruvate. If palmitoyl-DL-carnitine (20 μ M) was added in place of malate and pyruvate in an experiment such as that of Fig. 10 the extinction change due to previous decatetraenoyl-CoA synthesis was completely reversed.

(g) The effects of other fatty acids. The thiol esters of saturated unsubstituted fatty acids exhibit an increase in extinction over the free acid at 232 nm. This is a technically difficult wavelength at which to study mitochondrial suspensions, but the synthesis of these thiol esters could be inferred if the acids acted as inhibitors of decatetraenoyl-CoA synthesis. The results of such experiments are

Table 2. Inhibition of decatetraenoyl-CoA synthesis by other fatty acids

In each experiment decatetraenoyl-CoA synthesis was measured spectrophotometrically at 376 minus 412 nm. Mitochondrial protein (12 mg) was diluted in 3.0 ml of incubation medium containing 4 μ mol of arsenate and 20 nmol of pentachlorophenol. After 2 min 20 nmol of decatetraenoic acid was added together with another fatty acid. After a further 1 min 1 μ mol of ATP and 10 μ g of oligomycin was added. The final volume was 3.25 ml. The uninhibited rate was that observed in the presence of decatetraenoate alone.

Added fatty acid	Inhibition of decatetraenoyl-CoA synthesis (%)
Butyrate (33 μ M)	26
Octanoate (26 μ M)	95
Palmitate (16 μ M)	16

summarized in Table 2, from which it is apparent the ATP-dependent internal decatetraenoyl-CoA synthetase is maximally inhibited by octanoate, implying that the enzyme has mainly medium-chain-length specificity.

The kinetics of decatetraenoyl-CoA synthesis by submitochondrial fractions. GTP does not penetrate that fraction of the mitochondrial water that is impermeable to sucrose (Klingenberg & Pfaff, 1966) and neither does CoA (Yates & Garland, 1966). These observations make it unlikely that GTP can penetrate to the site where intramitochondrial CoA is located. In keeping with this is the fact that in experiments such as those in Figs. 5 and 6, added GTP (2 mM) was without effect on the rate of decatetraenoyl-CoA synthesis. To provide more direct evidence for the presence of both ATP- and GTP-specific decatetraenoyl-CoA synthetases, mitochondria were separated into soluble and membrane fractions after ultrasonic disintegration (see the Methods section).

Fig. 12 demonstrates the linear relationship between decatetraenoyl-CoA synthesis and the amount of soluble fraction, either ATP or GTP being used. The rates observed with the membrane fraction were about eightfold lower and were not studied further. The demonstration (Fig. 12) that either ATP or GTP can be used for decatetraenoyl-CoA synthesis does not in itself imply two distinct enzymes: unequivocal proof of this point requires the separation and characterization of two distinct proteins. However, studies of the apparent substrate affinities and inhibitor sensitivities of the ATP- and GTP-dependent activities reveal a number of marked differences.

Half-maximal activation with Mg^{2+} was obtained at 0.1 mM-magnesium chloride with the

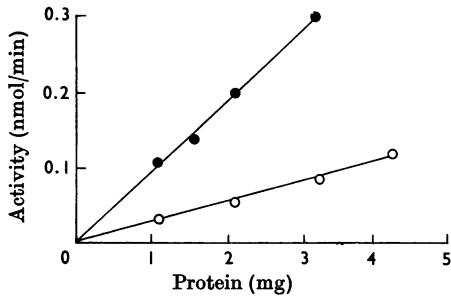

Fig. 12. Relationship of ATP- and GTP-dependent decatetraenoyl-CoA synthesis to the amount of protein present in the soluble fraction of mitochondria. Various additions of soluble fraction (0.1–0.4 ml) were made to a reaction vessel containing incubation medium, 5 μ mol of Mg^{2+} , 10 μ g of oligomycin, 60 nmol of decatetraenoic acid and 200 nmol of CoA to a final volume of 2.0 ml at 25°C. When a steady base-line had been recorded, the reaction was initiated by the addition of either 2 μ mol of ATP or 1 μ mol of GTP and the increase in extinction followed at 376 nm minus 420 nm with a dual-wavelength spectrophotometer. ●, ATP-dependent reaction; ○, GTP-dependent reaction.

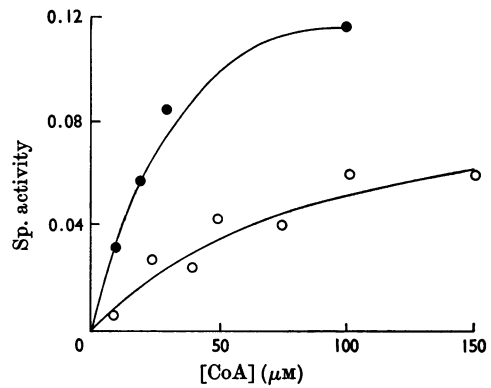

Fig. 14. Effect of various CoA concentrations on ATP- and GTP-dependent decatetraenoyl-CoA synthesis by the soluble fraction. Assay conditions were as given in the legend to Fig. 12 except that the protein concentration was held constant (values as in Fig. 13) and the CoA concentration was varied from 0 to 150 μ M. The K_m values calculated from reciprocal plots were 35 μ M- and 125 μ M-CoA for the ATP-dependent (●) and GTP-dependent (○) activities respectively.

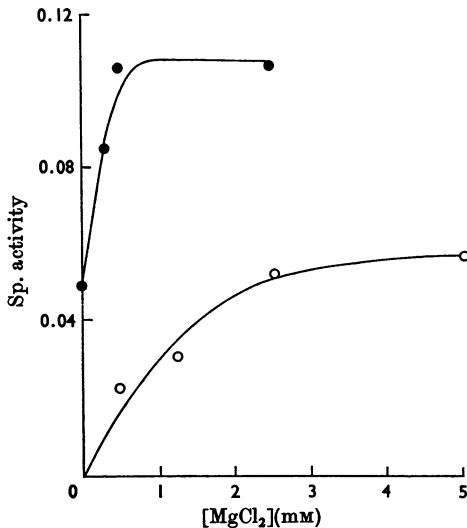

Fig. 13. Effect of various Mg^{2+} concentrations on ATP- and GTP-dependent decatetraenoyl-CoA synthesis by the soluble fraction. Assay conditions were as given in the legend to Fig. 12 except that the protein concentration was held constant [0.5 mg/ml for ATP-dependent reaction (●) and 1.0 mg/ml for GTP-dependent reaction (○)] and the amount of added $MgCl_2$ was varied (0–5 mM).

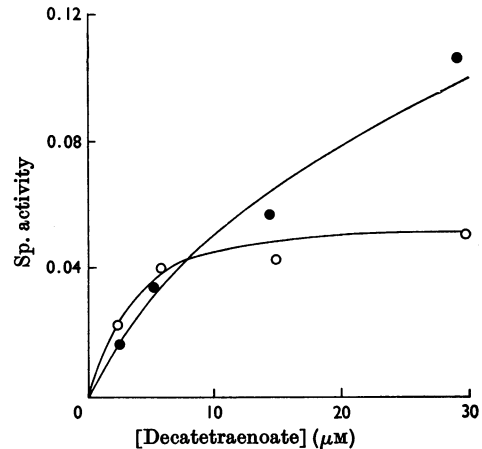

Fig. 15. Effect of various decatetraenoic acid concentrations on ATP- and GTP-dependent decatetraenoyl-CoA synthesis by the soluble fraction. Assay conditions were as given in the legend to Fig. 12 except that the protein concentration was held constant (values as Fig. 13) and the decatetraenoic acid concentration was varied from 0 to 30 μ M. The K_m values calculated from reciprocal plots were 28 μ M- and 5 μ M-decatetraenoic acid for the ATP-dependent (●) and GTP-dependent (○) enzymes respectively.

ATP-dependent activity whereas the comparable activation of the GTP-dependent activity needed 1 mM-magnesium chloride (Fig. 13). Differences in

the half-maximally activating concentrations of CoA and decatetraenoate were also apparent between the ATP- and GTP-dependent activities (Figs. 14 and 15).

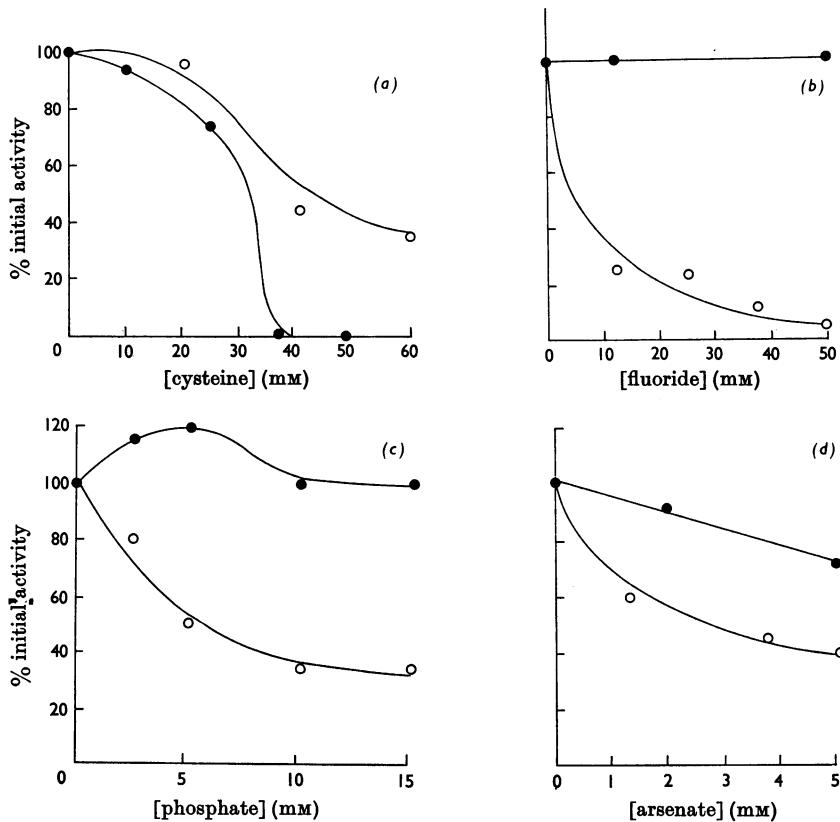

Fig. 16. Effect of various concentrations of cysteine, fluoride, phosphate and arsenate on the ATP- and GTP-dependent synthesis of decatetraenoyl-CoA. Assay conditions were as given in the legend to Fig. 12 except that the protein concentration was held constant (values as Fig. 13). In (a) the soluble fraction was prepared from mitochondria that had been ultrasonically disrupted in the additional presence of 0, 20, 40 and 60 mM-cysteine. In the remaining curves the effect of further additions to the reaction cuvette is shown: (b) NaF (0–50 mM); (c) potassium phosphate, pH 7.2 (0–15 mM) and (d) potassium arsenate, pH 7.2 (0–5 mM). ●, ATP-dependent reactions; ○, GTP-dependent reactions.

Both activities were inhibited by the presence of cysteine in the assay cuvette, the ATP-dependent activity being the more sensitive (Fig. 16a). Fluoride, an inhibitor of the GTP-specific acyl-CoA synthetase isolated by Galzigna, Rossi, Sartorelli & Gibson (1967), severely inhibited the GTP-dependent activity but did not affect the ATP-dependent activity (Fig. 16b). Phosphate, known to inhibit the GTP-specific acyl-CoA synthetase (Rossi *et al.* 1967), caused a slight stimulation of the ATP-dependent activity (Fig. 16c) but inhibited the GTP-dependent activity. Finally, arsenate was a stronger inhibitor of the GTP- than of the ATP-dependent activity (Fig. 16d). It should be remembered that these observations were all made with a crude preparation, namely the fraction of protein solubilized by ultrasonic disintegration of

mitochondria. It is therefore probable that the fraction contained Mg^{2+} , adenine and guanine nucleotides, enzymes that catalyse phosphate transfer between these nucleotides, and enzymes that catalyse other reactions (e.g. ATP hydrolysis). These considerations may explain the relatively low sensitivity of the GTP-dependent activity towards arsenate; nevertheless, it seems fairly certain from these results that there are both ATP- and GTP-specific decatetraenoyl-CoA synthetases in the soluble protein fraction of rat liver mitochondria.

The relationship between the decatetraenoyl-CoA synthetase and palmitoyl-CoA synthetase activities of submitochondrial fractions was investigated in the experiments shown in Table 3. It is apparent that the decatetraenoyl-CoA synthetases were

Table 3. Comparison of palmitoyl-CoA and decatetraenoyl-CoA (ATP- and GTP-dependent) synthetases in rat liver mitochondria

Specific activities are expressed as nmol of acyl-CoA/min per mg of protein. Dual-wavelength assays for decatetraenoyl-CoA synthesis were performed at 25°C in 2.0 ml of incubation medium containing 5 μ mol of MgCl₂, 10 μ g of oligomycin, 40 nmol of decatetraenoate, 200 nmol of CoA, 0.7–3 mg of protein, and started with 1 mM-ATP or GTP. Palmitoyl-CoA synthetase was assayed by sampling at 30 s intervals from 10 ml of incubation medium at 25°C containing approx. 5 mg of protein, 50 mg of defatted bovine plasma albumin, 5 μ g of rotenone, 50 μ g of oligomycin, 500 nmol of potassium palmitate, 10 μ mol of ATP and (to start the reaction) 1 μ mol of CoA. The rate of production of acid-insoluble CoA from CoA was linear for at least 2 min.

Fraction	Palmitoyl-CoA synthetase			Decatetraenoyl-CoA synthetase (ATP)		Decatetraenoyl-CoA synthetase (GTP)	
	% protein	Sp. activity	Recovery (%)	Sp. activity	Recovery (%)	Sp. activity	Recovery (%)
Mitochondria (ultrasonically disintegrated)	100	6.3	100	0.121	100	0.064	100
Soluble fraction	52.5	2.0	17	0.222	97	0.105	86
Membrane fraction	47.5	8.8	67	<0.010	<4	0.018	13

largely if not completely solubilized by ultrasonic disintegration whereas the palmitoyl-CoA synthetase activity remained mostly membrane-bound.

DISCUSSION

The use of decatetraenoic acid as a chromophoric substrate for mitochondrial acyl-CoA synthetases appears to be a specific and convenient means of direct and continuous assay of these enzymes in complex systems such as mitochondria. The validity of this technique depends among other things upon the metabolic inertness of the product, decatetraenoyl-CoA. This could be anticipated from the studies of Wakil & Hübscher (1960), who showed that hexa-2,4-dienoyl-CoA was not hydrated at a significant rate by enoyl-CoA hydratase (EC 4.2.1.17). Further evidence for the metabolic inertness of decatetraenoyl-CoA is provided by the close similarity between the absorption spectra (thiol ester minus free acid) observed when synthesis was made either with a purified enzyme or whole mitochondria (Figs. 3 and 4).

Decatetraenoate appears to be a substrate for an ATP-dependent acyl-CoA synthetase of predominantly medium-chain-length specificity, as shown by the results in Tables 2 and 3. The observations made when the GTP-dependent enzyme was operative do not permit a conclusion to be made about its chain-length specificity. The sensitivity of the solubilized GTP-dependent activity towards fluoride, phosphate and arsenate (Fig. 16) is in keeping with that observed by Galzigna *et al.* (1967) when studying a highly purified GTP-specific acyl-CoA synthetase from rat liver mitochondria.

Further support for the conclusion that decatetraenoate is a substrate for two distinct acyl-CoA synthetases is provided by a quantitative consideration of their requirements for CoA, Mg²⁺ and decatetraenoate; in each case the plots of substrate concentration against enzyme activity are dissimilar (Figs. 13, 14 and 15). These brief studies on the solubilized decatetraenoyl-CoA synthetases do little other than confirm the report of Galzigna *et al.* (1967). Nevertheless, it was essential in the present context to demonstrate in a soluble system that decatetraenoate was a substrate for both ATP- and GTP-specific acyl-CoA synthetases. More confident interpretation could then be made of the spectrophotometric observations of decatetraenoyl-CoA synthesis in intact mitochondria.

When mitochondrial decatetraenoyl-CoA synthesis proceeds to a spectrophotometric completion, about half of the mitochondrial CoA is still present as the free thiol (Fig. 8). This does not necessarily mean that the unacylated CoA is in a separate compartment, for the reaction could have come to a halt through reaching equilibrium. The mitochondrial situation is not strictly comparable with that obtaining when a purified enzyme is used with excess of ATP and decatetraenoate, and completion of acylation in the latter situation is a poor model for the mitochondria. That intramitochondrial decatetraenoyl-CoA synthesis can be reversed is apparent from experiments where CoA-acylating substrates were added, namely pyruvate, 2-oxoglutarate and palmitoyl-DL-carnitine (e.g. Fig. 9). More detailed studies of the equilibrium position of intramitochondrial decatetraenoyl-CoA synthesis would require the measurement of the intramitochondrial contents of the reactants of reactions 1 and 2.

Despite this, the demonstration of what is presumably the reversal of one or both of these reactions enables us to conclude that they share a common pool of CoA with pyruvate dehydrogenase, 2-oxoglutarate dehydrogenase, carnitine palmitoyl transferase and succinyl-CoA synthetase. Fritz (1968) has proposed that pyruvate dehydrogenase utilizes a CoA pool that is distinct from that used by fatty acid oxidation. Bearing in mind that the GTP-specific acyl-CoA synthetase is active with both long- and medium-chain-length acids (Galzigna *et al.* 1967), and that the medium-chain-length fatty acids are rapidly oxidized by liver mitochondria in the absence of carnitine, it seems likely that acyl-CoA synthesis via these routes occurs in the same intramitochondrial site as the enzymes of β -oxidation. Thus a common pool of CoA for pyruvate dehydrogenase and an acyl-CoA synthetase implies that the same pool serves for the other enzymes of β -oxidation.

The relationship of these and other enzymes to the inner and outer mitochondrial membranes is discussed in greater detail in the following paper (Haddock, Yates & Garland, 1970). On the basis of the results presented in the present paper, it can be concluded that there are at least three decatetraenoyl-CoA synthetases present in rat liver mitochondria, of which two are 'internal' in that they utilize endogenous CoA. The external activity probably corresponds to the palmitoyl-CoA synthetase of the outer membrane.

We thank the Medical Research Council for research expenses, the Science Research Council (B.A.H) and British Insulin Manufacturers (D.W.Y.) for grants, and the Royal Society and NATO Research Programme (grant 318) for funds to construct the dual-wavelength and split-beam spectrophotometers respectively.

REFERENCES

- Bremer, J., Norum, K. & Farstad, (1967). In *Mitochondrial Structure and Compartmentation*, p. 380. Ed. by Quagliariello, E., Papa, S., Slater, E. C. & Tager, J. Bari: Adriatica Editrice.
- Chance, B. (1961). In *CIBA Found. Symp: Quinones in Electron Transport*, p. 327. Ed. by Wolstenholme, G. E. W. & O'Connor, C. M. London: J. and A. Churchill Ltd.
- Chance, B. & Legallais, V. (1951). *Rev. scient. Instrum.* **22**, 727.
- Chance, B. & Williams, G. R. (1956). *Adv. Enzymol.* **17**, 65.
- Fritz, I. B. (1963). *Adv. Lipid Res.* **1**, 286.
- Fritz, I. B. (1968). In *Cellular Compartmentalization and Control of Fatty Acid Metabolism*, p. 39. Ed. by Gran, F. C. Oslo: Universitetsforlaget; New York and London: Academic Press.
- Galzigna, L., Rossi, C. R., Sartorelli, L. & Gibson, D. M. (1967). *J. biol. Chem.* **242**, 2111.
- Garland, P. B., Haddock, B. A. & Yates, D. W. (1969). In *FEBS Symp. vol 17: Mitochondria Structure and Function*, p. 111. Ed. by Ernster, L. & Drahotka, Z. London and New York: Academic Press.
- Garland, P. B., Shepherd, D. & Yates, D. W. (1965). *Biochem. J.* **97**, 587.
- Garland, P. B. & Yates, D. W. (1967). In *Mitochondrial Structure and Compartmentation*, p. 385. Ed. by Quagliariello, E., Papa, S., Slater, E. C. & Tager, J. M. Bari: Adriatica Editrice.
- Haddock, B. A., Yates, D. W. & Garland, P. B. (1970). *Biochem. J.* **119**, 565.
- Heldt, H.-W., Jacobs, H. & Klingenberg, M. (1964). *Biochem. biophys. Res. Commun.* **17**, 130.
- Heytler, P. G. (1963). *Biochemistry, Easton*, **2**, 357.
- Jaenicke, L. & Lynen, F. (1960). In *The Enzymes*, vol. 3, p. 3. Ed. by Boyer, P. D., Lardy, H. & Myrback, K. New York and London: Academic Press.
- Klingenberg, M. & Pfaff, E. (1966). In *Regulation of Metabolic Processes in Mitochondria*, p. 180. Ed. by Tager, J. M., Papa, S., Quagliariello, E. & Slater, E. C. Amsterdam: Elsevier Publishing Co.
- Mahler, H. R., Wakil, S. J. & Bock, R. M. (1953). *J. biol. Chem.* **204**, 453.
- Nicholls, D. G. & Garland, P. B. (1969). *Biochem. J.* **114**, 215.
- Rossi, C. R., Galzigna, L., Alexandre, A. & Gibson, D. M. (1967). *J. biol. Chem.* **242**, 2102.
- Rossi, C. R. & Gibson, D. M. (1964). *J. biol. Chem.* **239**, 1964.
- Tubbs, P. K. & Garland, P. B. (1964). *Biochem. J.* **93**, 550.
- van den Bergh, S. G. (1965). *Biochim. biophys. Acta*, **98**, 442.
- van den Bergh, S. G. (1967). In *Mitochondrial Structure and Compartmentation*, p. 400. Ed. by Quagliariello, E., Papa, S., Slater, E. C. & Tager, J. Bari: Adriatica Editrice.
- Wakil, S. J. & Hübscher, G. (1960). *J. biol. Chem.* **235**, 1554.
- Yang, C. C. (1954). *Rev. Scient. Inst.* **25**, 807.
- Yates, D. W. & Garland, P. B. (1966). *Biochem. biophys. Res. Commun.* **23**, 460.
- Yates, D. W. & Garland, P. B. (1967). *Biochem. J.* **102**, 40p.
- Yates, D. W., Shepherd, D. & Garland, P. B. (1966). *Nature, Lond.*, **209**, 1213.