

How *Chlamydomonas* Keeps Track of the Light Once It Has Reached the Right Phototactic Orientation

Klaus Schaller, Ruth David, and Rainer Uhl

Abteilung Physikalische Biologie der Ludwig Maximilians Universität, D-80638 München, Germany

ABSTRACT By using a real-time assay that allows measurement of the phototactic orientation of the unicellular alga *Chlamydomonas* with millisecond time resolution, it can be shown that single photons not only induce transient direction changes but that fluence rates as low as $1 \text{ photon cell}^{-1} \text{ s}^{-1}$ can already lead to a persistent orientation. Orientation is a binary variable, i.e., in a partially oriented population some organisms are fully oriented while the rest are still at random. Action spectra reveal that the response to a pulsed stimulus follows the Darnall-nomogram for a rhodopsin while the response to a persistent stimulus falls off more rapidly toward the red end of the spectrum. Thus light of 540 nm, for which *chlamy*-rhodopsin is equally sensitive as for 440-nm light, induces no measurable persistent orientation while 440-nm light does. A model is presented which explains not only this behavior, but also how *Chlamydomonas* can track the light direction and switches between a positive and negative phototaxis. According to the model the ability to detect the direction of light, to make the right turn and to stay oriented, is a direct consequence of the helical path of the organism, the orientation of its eyespot relative to the helix-axis, and the special shielding properties of eyespot and cell body. The model places particular emphasis on the fact that prolonged swimming into the correct direction not only requires making a correct turn initially, but also avoiding further turns once the right direction has been reached.

INTRODUCTION

Phototaxis means orientation parallel to the ambient light and movement toward (positive phototaxis) or away from (negative phototaxis) the light source (Pfeffer, 1904; Buder, 1917). To achieve this goal the organism has been assumed to possess the ability to determine the light direction and, using some sort of internal signal processing (Foster and Smyth, 1980), to evaluate intensity data and adjust its orientation accordingly (Pfeffer, 1904; Buder, 1917; Feinleib, 1975; Foster and Smyth, 1980; Smyth et al., 1988; Ruffer and Nultsch, 1991; Witman, 1993).

During forward-swimming, *Chlamydomonas* uses its two flagella in a breaststroke-style fashion (Foster and Smyth, 1980; Ruffer and Nultsch, 1985, 1991). However, instead of swimming on straight lines, the alga rotates counterclockwise around its longitudinal axis and thus pursues a helical path (Buder, 1917; Ruffer and Nultsch, 1985; Witman, 1993). In the course of the body rotation the photoreceptor molecules in the eyespot perceive a sinusoidally modulated light intensity. Modulation decreases when the "right orientation" is approached and vanishes when tracking- and light-direction coincide (Foster and Smyth, 1980). This has been assumed to constitute a "tracking signal" that steers the cells into the right direction; i.e., the cells are thought to determine this amplitude and to pursue a turning action until the modulation has vanished. This model, however, does not allow distinguishing between a swimming direction

toward or away from the light and does not explain how the switch between positive and negative phototaxis is brought about. The following communication addresses this problem and proposes a solution.

By using a novel assay that allows measurement of phototactic orientation with high precision and millisecond time resolution (Schaller et al., unpublished observations) we have monitored both the orientation process and the persistence of a once-achieved orientation under conditions where only one or a few photons are absorbed per cell and second. We found a different wavelength dependence for the two processes, similarly to what has been noted before by Nultsch et al. (1971), Foster et al. (1984), Foster and Smyth (1980), and ourselves (Uhl and Hegemann, 1990 a,b), i.e., measurements that probe the phototactic migration yield an action spectrum which falls off much more rapidly toward the red than measurements that probe the actual orientation process, i.e., direction changes. As Foster and Smyth (1980) have pointed out, using threshold action spectra can reduce the difference between the two diverging results, but they give no specific explanation for what could be responsible for this behavior in the given case. We have therefore studied the discrepancy in detail under conditions where both the orientation process and the process of being and staying oriented can be registered simultaneously, and this has led us to extend existing models of phototaxis. Our new model provides an explanation for the above discrepancy, it explains how orientation can be achieved with short flashes of light (Feinleib, 1975) or even, as an all-or-nothing event, by single photons (see below) and it offers an explanation for the observation that orientation may be reached with a time course too rapid to make use of a modulated intensity signal: 250 ms after the onset of orientation, i.e., after $\frac{1}{2}$ rotation period, half-maximal orientation is already achieved.

Received for publication 31 October 1996 and in final form 28 May 1997.

Address reprint requests to Rainer Uhl, Abteilung Physikalische Biologie der Ludwig Maximilians Universität, Menzinger Strasse 67, D-80638 München, Germany. Tel.: +49-89-1786-1227; Fax: +49-89-1786-1185; E-mail: uhl@botanik.biologie.uni-muenchen.de

© 1997 by the Biophysical Society

0006-3495/97/09/1562/11 \$2.00

MATERIALS AND METHODS

C. reinhardtii strain 806 mt⁻ cells were grown on agar plates for 5 days and differentiated overnight in nitrogen-free liquid minimal medium (NMM: 80 μ M MgSO₄, 100 μ M CaCl₂, 3.1 mM K₂HPO₄, 3.4 mM KH₂PO₄, pH = 6.8 plus trace elements) at a cell concentration of 7×10^6 cells/ml as previously described (Hegemann et al., 1988). The phototactically most active cells were photoselected and dark-adapted (Uhl and Hegemann, 1990a,b) under optimal aeration for at least another hour in a phosphate buffer containing 3.1 mM K₂HPO₄, 3.4 mM KH₂PO₄, 100 μ M CaCl₂, and 80 μ M Mg₅O₄ adjusted to pH 6.8. Before the experiment, cells were diluted to 10^6 cells/ml and placed in a cuvette. Fresh aliquots were taken for every set of exposures. Strain 806 mt⁻, which exhibits only negative phototaxis (Hegemann et al., 1988), was chosen in order to assure that only a single orientation response was obtained under all conditions, thus simplifying the interpretation considerably.

The optical set-up, which has been described in detail elsewhere (Schaller et al., unpublished observations) is schematically depicted in Fig. 1 a and in detail in Fig. 1 b. Parallel monitoring light of 880 nm was scattered by the cells in the cuvette and the scattered light was collected by

a lens-combination. In the focal plane of the lens-combination, 12 detectors (Siemens SFH 2030-F) were arranged on a circle, measuring light scattered at a constant scattering angle " ϑ " and on this circle like the ciphers on a clock, corresponding to a variable scattering angle " φ ". Maximal signals, reflecting the transition of the population from an unoriented to an oriented state, were obtained at $\vartheta = 16^\circ$ and an angle " φ " corresponding to the 3 o'clock position.

The continuous actinic light had a bandwidth of 22 nm and the pulsed actinic light was derived from a commercial photo-flash of 1 ms duration (Metz Meccablitz, Germany). Both actinic light sources could be coupled into the system by means of a quartz fiber (Fig. 1 b) such that they either originated from within the detector circle (1), faced the detector circle (2 or 3), or came from one or the other side of it (4 or 5).

Photocurrents were converted into voltages using current-to-voltage converters with a feedback resistor of 10 M Ω . Their output was fed into logarithmic amplifiers (Uhl et al., 1987) and subsequently sampled by an ITC-16 (Instrutech) A/D-converter, controlled by a power Macintosh computer (Apple) and the IGOR-Xops, provided by R. Bookman.

Motion analysis was carried out under the microscope, using a 10 \times objective, a commercially available CCD-video camera, and the program BIOTRACK (Dr. K. Vogel, Germany). Absolute photon exposures were determined using a calibrated, large-area photodiode (S 1337-BQ, Hamamatsu).

The position of the eyespot relative to the helical path of the organism was determined in an upright microscope, using a 63 \times water immersion objective (Zeiss Achroplan water 63 \times , NA 0.90). Cells were placed in a chamber which had a coverslip as bottom and was open on top. The monitoring beam (880 nm) was produced by a light-emitting diode (Hitachi HLP 40). It illuminated the cells from below. The orienting actinic light was delivered from one side, using the fiber cw-delivery system described elsewhere (Schaller et al., unpublished observations), and the flash was applied from a position in the same plane, i.e., perpendicular to the optical axis of the microscope and 135 $^\circ$ away from the cw-light source. In both cases the light was collimated using appropriate lenses.

A slow scan CCD-camera (Theta, Gröbenzell, Germany) was placed in the image plane. Its frame transfer structure allows it to acquire two subsequent images spaced only 0.2 ms apart (Messler et al., 1996). One image was recorded with several hundred milliseconds exposure time. It was meant to produce continuous helical traces of as many as possible algal cells. Due to the high magnification, however, only a tiny fraction of the cells produced a clearly visible helical trace within the narrow depth of field. A second image was taken shortly after the first one, and during its exposure a flash of orange light was applied. A fraction of the cells that had produced a helical trace in one plane also produced a measurable reflex, and since the two images were taken so shortly after each other, the position of the reflex could be identified relative to the helical path.

To test the effectiveness of actinic light of varying wavelength and angle of incidence with respect to its ability to induce stop-responses, single cells were sucked into a pipette and held in the specimen plane of the confocal microscope (Schaller et al., 1997). By repeated sucking and release action the organism could be oriented such that the eyespot directly faced one objective. This 0 $^\circ$ position, which was considered confirmed when maximal reflexes were seen, [for details see Schaller et al. (1997)], served as a reference point from which, by rotating the pipette, various defined angles of incidence could be reached. Flashes of monochromatic light were then applied through the microscope optics and the frequency of stop-responses was determined from video recordings. The undulation movement of the two flagella, which sets in ~ 30 ms after the flash, could thus be identified easily.

RESULTS AND DISCUSSION

Measuring orientation of an organism exhibiting optical anisotropy

Optically homogeneous spherical objects exhibit spherical scattering symmetry (Hecht, 1974). A deviation from per-

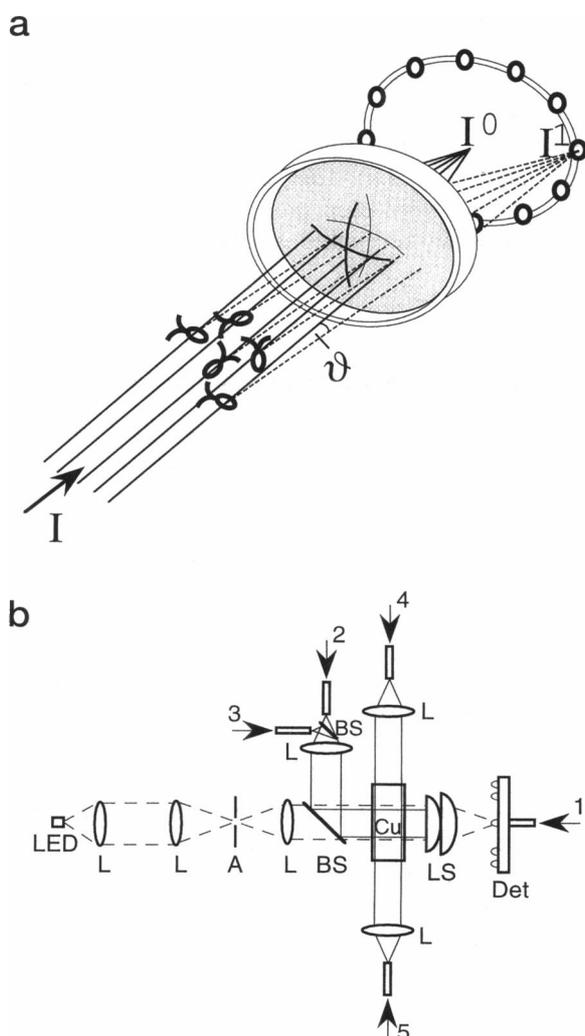

FIGURE 1 (a) Schematic diagram of the optical set-up for the determination of orientation. (b) Detailed plan of the optical set-up. "L" are lenses, "A" an aperture stop, "BS" beam-splitters, "Cu" the cuvette, "LS" a lens combination, and "Det" the detector ring. The possible illumination schemes are numbered from 1 to 5.

fect spherical appearance or a nonsymmetrical mass distribution within the object renders the scattering profile asymmetrical. However, a population of such scatterers produces a symmetrical scattering profile when numerous scatterers of random orientation are allowed to contribute to the measurement. Only in an oriented population the asymmetrical scattering profile of the individual scattering object becomes apparent. As a consequence, the transition from a random to an ordered population of an inhomogeneous scattering object causes a transition from a symmetrical to an asymmetrical scattering profile, and this transition can be used to monitor time course and extent of the orientation of an inhomogeneous scatterer. As we have demonstrated elsewhere, *Chlamydomonas* is such an inhomogeneous scatterer (Schaller et al., unpublished observations).

Fig. 2 shows kinetic traces of the orientation process in continuous light of 488 nm. When the photon flux density was increased from 2×10^{15} photons $\text{m}^{-2} \text{s}^{-1}$ to 2×10^{18} photons $\text{m}^{-2} \text{s}^{-1}$, the signals grew bigger and became faster. Both slope and final amplitude as a function of irradiance are best described by the equation (Naka and Rushton, 1966).

$$A = A_0 I^n / \text{const.} + I^n$$

The exponent n is 1.3, i.e., relatively close to one.

The irradiance required for a half-maximal response was 5×10^{15} photons $\text{m}^{-2} \text{s}^{-1}$ when light of 488 nm was used. Given that there are $\sim 22,000$ – $30,000$ rhodopsins per cell (Foster and Smyth, 1980; Uhl and Hegemann, 1990b; Beckmann and Hegemann, 1991; Deininger et al., 1995), that their absorption cross-section " σ " is close to that of other rhodopsins, i.e., $1.5 \times 10^{-20} \text{m}^2$ (Foster et al., 1984; Smyth et al., 1988; Uhl and Hegemann, 1990b) and that their photochemical quantum efficiency is ~ 0.66 (Foster et al., 1984; Smyth et al., 1988), one rhodopsin is photoisomerized per cell and second under these conditions. A statistical examination on the basis of electrophysiological measurements of the photoreceptor current (Beck, 1996) comes to the same conclusion, namely that at 5×10^{15} photons $\text{m}^{-2} \text{s}^{-1}$ the cells are dealing with individual photon absorption

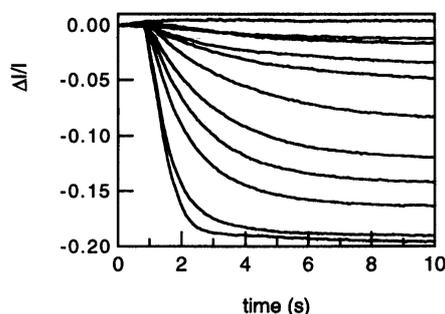
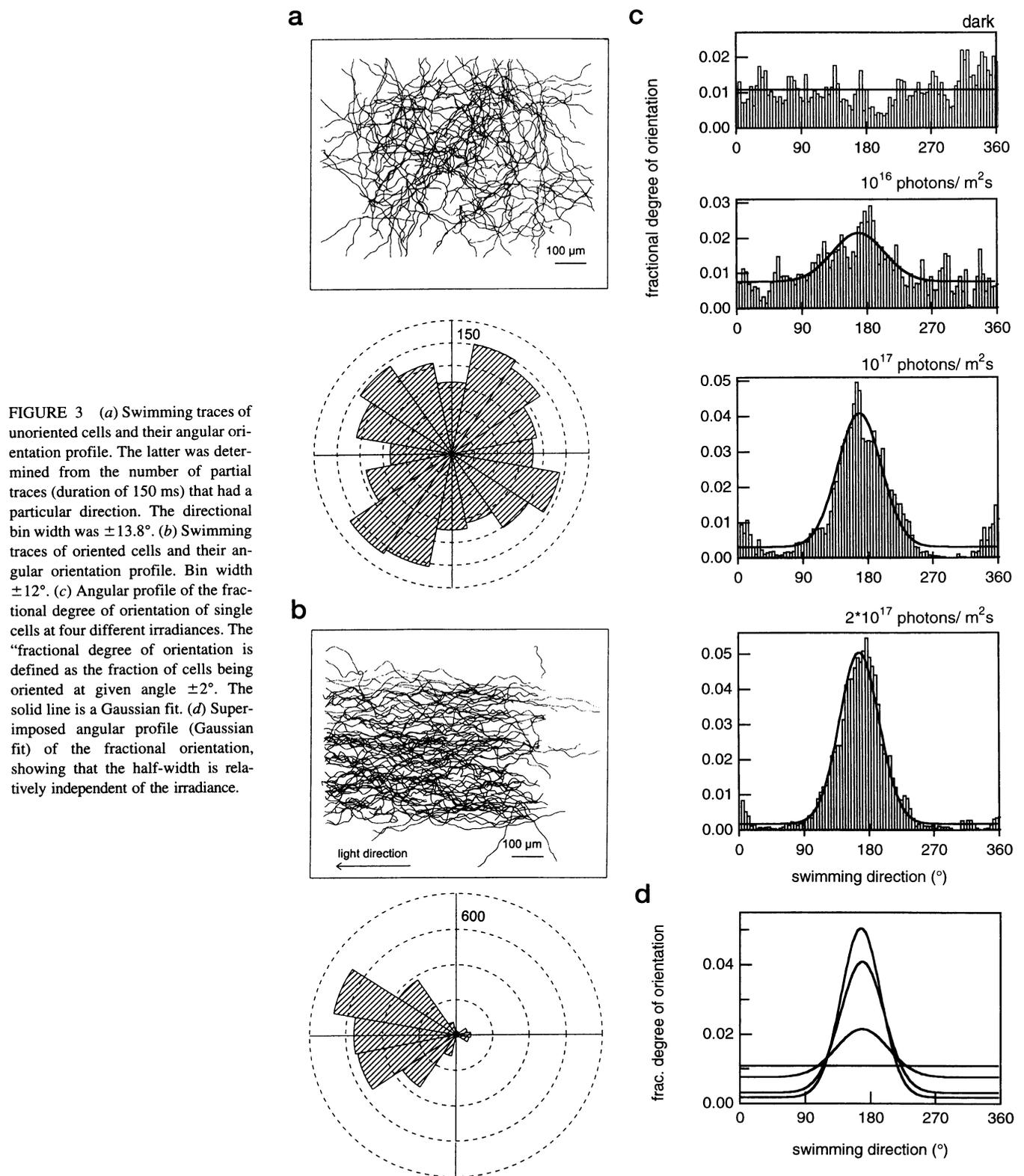

FIGURE 2 Time course of the orientation process measured at 10 different irradiances (3 o'clock detector, wavelength of the actinic light: 500 nm). The irradiances were, from top to bottom: 1.7×10^{14} , 6.3×10^{14} , 1×10^{15} , 1.7×10^{15} , 3.2×10^{15} , 6.3×10^{15} , 1×10^{16} , 1.7×10^{16} , 3.2×10^{16} , 6.3×10^{16} photons $\text{m}^{-2} \text{s}^{-1}$.

events. The nearly linear increase in signal amplitude with increasing irradiance must therefore arise from an increased number of cells that have "seen" a single photon and that the absorption of two photons does not lead to a significantly better orientation. This conclusion, which may not be obvious at first sight, is a direct consequence of the quantal nature of light: since the absorption of single photons is an all-or-nothing event, a population response, whose extent is graded with photon exposure under conditions where, on average, only single photons are absorbed, must reflect an increased fraction of cells contributing to the population response (Uhl and Hegemann, 1990b). To test the assumption that two absorbed photons do not produce a much better orientation than one, we have examined the orientation process of single cells under the microscope. Fig. 3 *a* shows microscopic traces of cells in a randomly oriented population and a statistical analysis of their orientation, whereas Fig. 3 *b* shows the same for oriented cells. The broadness of the angular distribution of swimming directions in darkness and at three different irradiances is shown in Fig. 3 *c*. The better overall orientation at higher irradiances does not mean that the individual cells were oriented better, it merely means that a larger fraction of the cells was oriented. All oriented cells, however, appeared to have the same degree of orientation (Fig. 3 *d*). This lends further support to the notion that the orientation process is a binary statistical event, which can be evoked by the absorption of single photons.

Phototactic action spectrum in continuous light

The identification of *Chlamy*-rhodopsin as the sole photoreceptor in *Chlamydomonas* rests mostly on action spectroscopy (Foster and Smyth, 1980; Uhl and Hegemann, 1990b; Harz and Hegemann, 1991; Kröger and Hegemann, 1994). However, while it appears to be proven beyond doubt that the photoreceptor of the stop response is a rhodopsin with an absorbance maximum ~ 490 nm (Harz and Hegemann et al., 1991; Zacks et al., 1993), there is still no definite proof that the photoreceptor responsible for phototaxis is the same. We have therefore tried to measure an action spectrum for the degree of orientation achieved using very dim stimuli of continuous light. Fig. 4 depicts stimulus response curves for the degree of orientation as determined by light scattering experiments. In Fig. 4 *a* actinic light of 488 nm and below was used, whereas in Fig. 4 *b* actinic light of 488 nm and above was applied. The light titrations in Fig. 4 *a* yielded the expected results, i.e., the curves were parallel-shifted and their sensitivity was highest at 488 nm and decreased with decreasing wavelength. From these data one could construct the low-wavelength tail of an action spectrum in complete agreement with the Dartnall-nomogram for a rhodopsin (Dartnall, 1972). The stimulus response curves in Fig. 4 *b*, however, acquired at wavelengths >490 nm, exhibited a totally different behavior. Not only were the curves shifted, they became compressed the more the actinic



wavelength was shifted toward the yellow part of the spectrum. Light of 530 nm, which should have the same efficiency to excite rhodopsin as 450-nm light, had a greatly reduced efficiency with respect to the orientation process, and 550 nm yielded hardly any orientation at all. This

cannot be accounted for by photochromic effects, since under conditions where only single photons were absorbed per cell and second, a photolysed rhodopsin will, on average, have to wait five hours before it “sees” another photon. Parallel experiments performed on single cells under the

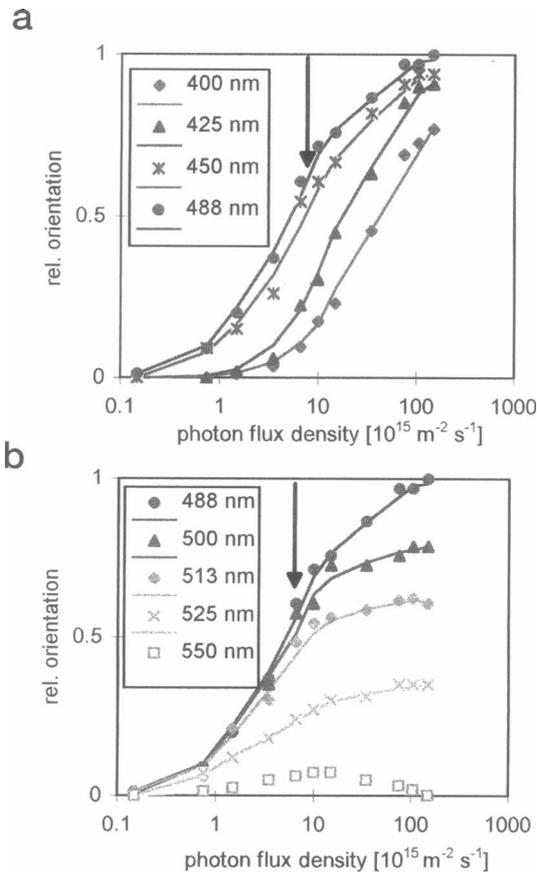

FIGURE 4 Light-titration of the degree of orientation induced by continuous light of wavelengths between (a) 400 and 488 nm and between (b) 488 and 550 nm. The arrow marks the photon flux at which 1 photon is absorbed per cell and second at 488 nm, i.e., 5×10^{15} photons $m^{-2} s^{-1}$.

microscope showed that there was still some orientation in yellow light, but that the angular distribution became progressively broader with increasing wavelength (data not shown).

The above data make it very difficult to construct a meaningful action spectrum above 520 nm. Even though action spectra should always be constructed from threshold experiments, a fact that has been stressed repeatedly by Foster and colleagues [Foster et al. (1984); Smyth et al. (1988)], one wonders how threshold data have been obtained above 530 nm by these authors given the low degree of orientation attained with yellow light, no matter how dim.

Our results are reminiscent of the action spectrum of Nultsch et al. (1971), which exhibits a sharp decline in sensitivity above 500 nm and hardly any sensitivity above 540 nm. It was derived from migration distance data. Clearly, when there is no persistent orientation, as indicated by the present study, there cannot be a net movement in one direction.

Phototactic action spectrum under pulsed light conditions

The first step in phototaxis is a light-induced direction change (Pfeffer, 1904; Buder, 1917). In a previous study

based on light-scattering transients obtained from an unoriented population, we have proposed that direction changes can be induced by single photons (Uhl and Hegemann, 1990a,b). At that time we did not understand the physical background of the signals, which we now do. Moreover, by preorienting the population, much larger signals can now be obtained. They reflect light-induced disturbances of an existing orientation. A dim flash of green light (2×10^{16} photons m^{-2}) was applied perpendicularly to the orienting light. It led to a transient disturbance of the equilibrium orientation which manifested itself as transient light-scattering intensity change. The periodicity seen in the flash-induced traces had a frequency of ~ 2 Hz, very close to the rotational frequency of the helical movement (Foster and Smyth, 1980; Ruffer and Nultsch, 1985). This “tumbling-response” can also be evoked by the absorption of single photons.

We have determined an action spectrum for such single photon-induced disturbances using a pulsed light source and an “equal response” approach. To make sure that the wavelength dependence of the shading due to eyespot apparatus and the other cell pigments did not perturb the measurement; the measurement was performed under conditions where the photoreceptors assumed a constant angle with respect to the actinic light, i.e., cells were oriented such that they swam directly toward the flash. With these precautions taken, dim flashes, i.e., photon exposures that produced only one or a few photoisomerizations per cell, produced small characteristic signals which exhibited an identical shape at all wavelengths and differed only in their sensitivity (the reciprocal of the exposure required for a given response reflects the sensitivity of the system at a given wavelength). An action spectrum constructed this way (Fig. 5) exhibits the expected rhodopsin shape and fits the Dartnall nomogram. So from these data there is no evidence for

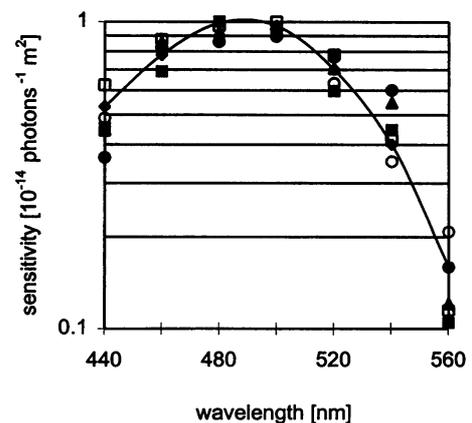

FIGURE 5 Action spectrum of flash-induced transient orientation changes compared with the Dartnall nomogram. Sensitivity was defined as the inverse of the exposure required for a given, above-threshold transient response. The five symbols correspond to five different experiments that were carried out on different days. Cells were oriented by green light (500 nm, 1×10^{16} photons $m^{-2} s^{-1}$) which faced the detector ring and the perturbing flash was applied from the opposite direction.

the involvement of any other photoreceptor in the onset of phototactic orientation. The discrepancy with respect to the orientation in continuous light, however, remains to be elucidated and we feel that it is a key issue for the understanding of phototaxis.

On the geometry of the helical path and its significance for oriented swimming

To aid the following discussion we want to recapitulate some basic features of the helical swimming of *Chlamydomonas*: *Chlamydomonas* uses its two flagella in a breast-stroke-like fashion (Rüffer and Nultsch, 1985). A different beat efficiency of the two flagella (Rüffer and Nultsch, 1985) would not explain why the organism swims on a helical path, it would only make it swim in circles. There is, however, an additional rotation around the longitudinal cell axis, which turns the circular movement into a helical one. While the reasons for this cell rotation are not yet clear (Rüffer and Nultsch, 1985, propose an out-of-plane component of the beat), it is known that this rotation is counter-clockwise, and determines the handedness of the resulting helix. Another logical consequence of the asymmetrical beating pattern leading to a helical movement is that the two flagella are always radially oriented with the dominating flagellum pointing to the outside.

Single absorbed photons can cause a reorientation of a cell population. Since for an oriented cell any further turn is detrimental, it needs to keep its photoreceptors protected from any further photon absorption once it is oriented. Consequently, the oriented state must be a state of minimal photon absorption probability if it is to constitute a stable equilibrium state. Imagine—in analogy to an energy hypersurface in physics—a “photonabsorption hypersurface” which describes the probability of photon capture as a function of the two angular orientations ϑ and φ relative to the direction of light (Fig. 6 a). This photonabsorption hypersurface must assume a minimum when tracking direction and light direction coincide. If this state has been reached, the signal that tells the organism not to turn anymore is not the now-reached constancy of perceived light intensity, which needs to be interpreted by the organism, but it is the absence of an internal, light-induced signal.

As we have stated previously, both flagella are always radially oriented with respect to the helical axis. This means that while they assume a constant angle ϑ relative to the helix axis, their angle φ precedes around it, assuming angles between 0 and 360°. This holds for any point on the surface of the organism, including the eyespot located close to the equator of the cell. If it were located within the beating plane of the two flagella, the “viewing direction” of the eyespot and the light would form a right angle for cells swimming toward or away from the light. So while under these conditions the modulation of the perceived intensity would vanish for an oriented cell, it would neither be minimal, nor would it allow the organism to determine

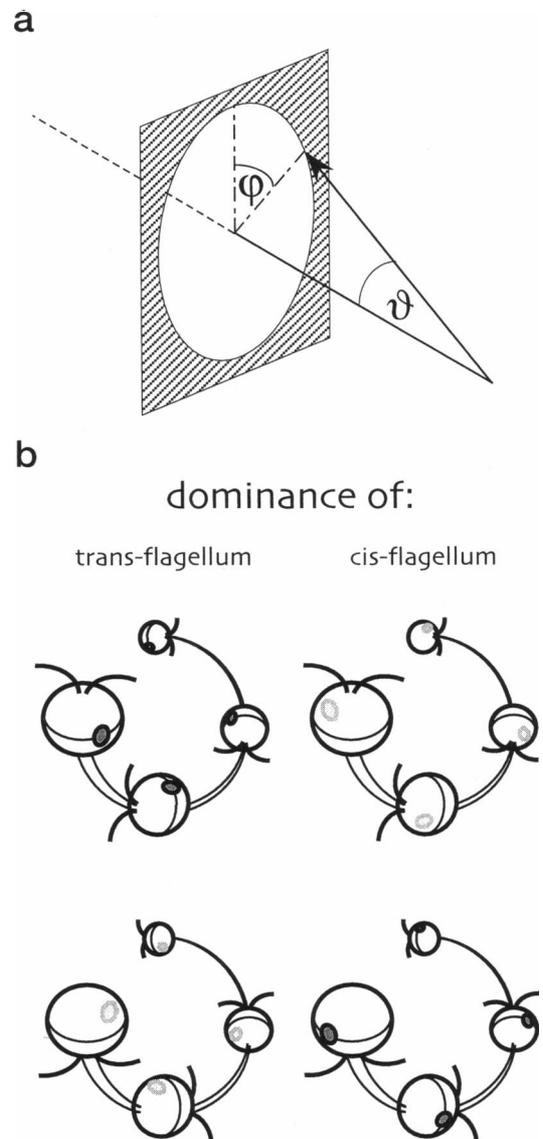

FIGURE 6 (a) Definition of the two angles ϑ and φ which describe the viewing direction (directivity) of the eyespot relative to the direction of light. (b) Viewing the helical swimming path of a *trans*- respectively *cis*-dominated alga, moving directly toward the observer. A dark shaded eyespot means that it can be directly viewed by the observer, while a lightly shaded eyespot means that there is the cell body between eyespot and observer.

whether it was swimming toward or away from the light. The probability of photon capture would only be attenuated by a factor of two for unpolarized light compared to the fully exposed orientation, and consequently the chance of further direction changes would be high. Following this line of reasoning it now makes sense why evolution has placed the eyespot $\sim 45^\circ$ outside of the beating plane. A direct consequence of this “geometrical trick” is that a cell swimming parallel to the light direction, i.e., for which tracking- and light-direction coincide, still perceives a constant light intensity over a helical period. However, four possible configurations need to be distinguished now as demonstrated in

Fig. 6 *b*: the cell may swim toward or away from the observer, and either the *cis*- or *trans*-flagellum may be dominating. In all four cases the orientation of the eyespot relative to the helical axis is invariant, but due to the 45° between eyespot and beating plane two possible orientations of the eyespot relative to the swimming direction exist, depending on whether the *cis*- or the *trans*-flagellum beats stronger. If *trans* dominates, light originating from the position of the observer can always reach the photoreceptors directly, while light coming from the opposite site has to pass through part of the cell and the interference reflector before it strikes the photoreceptor molecules. On this passage the light intensity gets attenuated to a variable degree, as we know from microspectrophotometric measurements (Schaller et al., 1997a). The "directivity" of the eyespot therefore attains a forward or backward component, exposing, respectively protecting it from the light. Since only shielded photoreceptors guarantee that the right orientation is a stable equilibrium position, this state of minimal, constant probability of photon capture must be assumed when the cells are oriented. So negatively phototactic algae must swim with a forward raked eyespot, i.e., with a dominant *trans*-flagellum. This immediately explains the poor orientation achieved with yellow light: even though the eyespot is raked forward, i.e., away from the light, the poor shielding provided by cell body and eyespot (Schaller et al., 1997a) makes the probability of photon capture only slightly reduced when the cell is oriented. In fact, we can even rationalize the observation that the slight orientation achieved with 1.5×10^{16} photons $m^{-2} s^{-1}$ disappears again at higher photon flux densities. If, due to poor shielding, the stimulus/response curve for *orienting* direction changes in organisms with maximally exposed photoreceptors is only slightly shifted to the left compared to the stimulus/response curve for *disorienting* direction changes in organisms which swim away from the light, the chance to maintain the right orientation is the difference between the chances for orientation and disorientation. It is bound to assume a maximum between the two half-points of the respective stimulus/response curves. This is the case as can be judged from the action spectrum measured under pulsed light conditions where at 550 nm half-maximal signal amplitudes require 1.5×10^{16} photons $m^{-2} s^{-1}$. Moreover, as the height of this maximum should get smaller the closer the two curves approach each other, i.e., the lower the contrast, the results in Fig. 4 *b* would indicate that at 550 nm the contrast ratio must be <1.5 . This prediction is also met, as will be shown below.

Measuring the degree of protection for a population of oriented cells

To test the validity of the above prepositions we first wanted to demonstrate directly that oriented cells protect their photoreceptors from the orienting. A population of strain 806, which, under ordinary light conditions shows exclusively

negative phototaxis (Uhl and Hegemann, 1990a), was oriented using blue continuous light. A "disturbing flash" of various wavelengths was then applied from three different directions (Fig. 7 *a*) and the threshold sensitivity, i.e., the exposure at which a measurable turning action became manifest, was determined. The resulting sensitivity curves (Fig. 7 *b*) were normalized with respect to the action spectrum (Fig. 6 *b*). Light originating from the direction into which the algae were swimming was found to be much more effective than light coming from the opposite direction. The difference was maximal in the blue and declined toward the red. Light coming from the side, on the other hand, was similarly effective as light coming from the front direction, with a distinct relative sensitivity maximum around 550 nm, the peak of reflectivity of the interference reflection. The fact that the "contrast ratio," i.e., the sensitivity for head-on and for back-illumination, is only 4 in the blue, i.e., lower than what the microspectrophotometric absorbance measurements have indicated (Schaller et al., 1997a), is not surprising: not all cells of the population are perfectly oriented, and the "unoriented" fraction of the population is not as well protected from head-on photons as

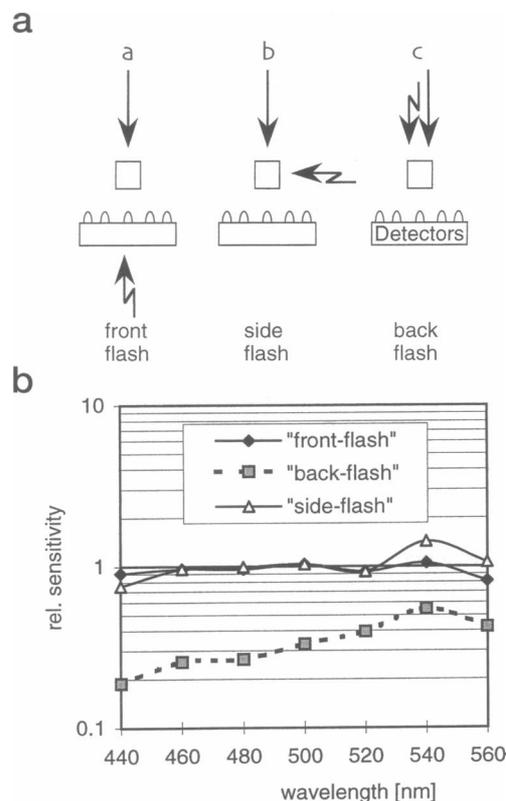

FIGURE 7 (a) Three excitation configurations for an actinic flash \rightarrow disturbing the orientation of an oriented population. Cells were preoriented with 500 nm light \rightarrow (1×10^{16} photons $m^{-2} s^{-1}$) and flashed with wavelengths between 425 and 575 nm from the front (a), from the side (b), and from the back (c). \square denotes the cuvette and --- the detector-array. (b) Wavelength-dependent sensitivity of the three configurations, normalized to the rhodopsin spectrum (taken from Fig. 4).

the oriented fraction. Consequently there will be a response from these “naughty” cells at lower exposures than from their oriented counterparts, and this could lead to an over-estimation of the sensitivity. An additional explanation could be that the absorbance of the cell is less when the light reaching the photoreceptor layer does not have to cross the cell radially but at a very shallow angle, as is the case in *Chlamydomonas*.

Geometrical requirements for optimal protection of photoreceptors in oriented cells

Given the geometry of the alga and its helical path, a successful shielding action is only guaranteed for an organism swimming away from the light when the *trans*-flagellum dominates and the eyespot is raked in a forward/inward direction. This was experimentally verified.

By using infrared light the helical movement of single algae could be monitored under the microscope with a slow-scan CCD camera, which was allowed to integrate for several seconds. Provided the organism was staying within the focus plane of the objective—a rarely encountered situation—the helix could be visualized as a sinusoidal projection. Several thousand of such trajectories were recorded from oriented strain 806 cells, swimming away from a continuous blue light. The experiment was terminated by a flash of yellow light (reflectivity of the eyespot is best at 550 nm, see Schaller et al., 1997a), which was synchronized with the recording of a second frame. The resulting image was searched for reflexes of the flash, which could only be seen when the eyespot assumed an angle halfway between that of the incoming light on one hand and the camera on the other hand (Fig. 8 a). Thus it was possible to determine at which position relative to the helical period a favorable, i.e., reflecting orientation, of the eyespot was reached. The result shown in Fig. 8 b supports the above proposition that the eyespot is raked forward/inward and that the *trans*-flagellum dominates in an organism swimming away from the light.

To determine the exact degree of shielding for the orientation of the eyespot where shielding is most needed (i.e., when the cell is oriented) and for all other orientations, we have carried out a “psychophysical test” on single cells, a so-called “frequency of seeing” experiment. Frequency of seeing experiments were first carried out by Hecht et al. (1942) in order to determine the photon requirement of human vision. They applied stimuli containing a known number of average photons and determined the probability with which the stimulus was perceived by a test person. By increasing the stimulus brightness, stimulus-response curves were recorded and their shape was used to determine how many photons were required for a stimulus to become noticeable. We have carried out similar experiments with algal cells held with a micropipette. The cells were rotated with respect to the incoming light in order to determine how the photon requirement changed with orientation relative to the stimulating light. Since our test specimen could not be interrogated directly whether it had seen light, we used one

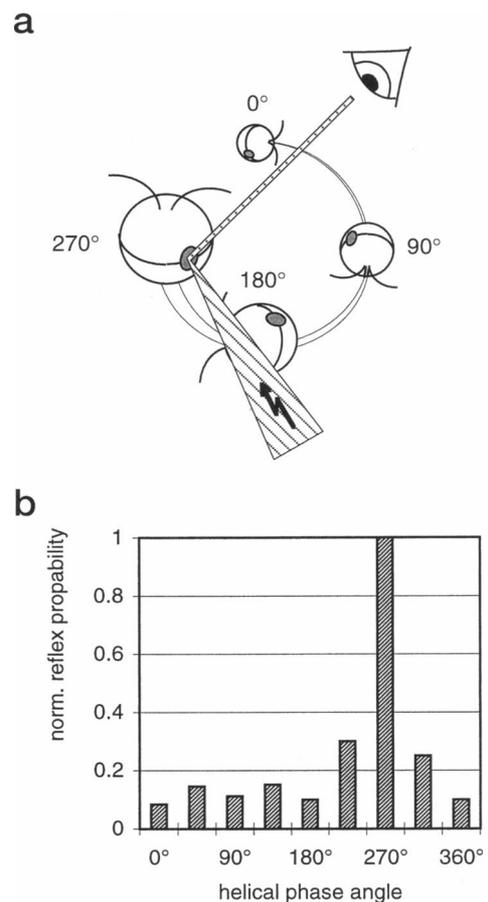

FIGURE 8 (a) Geometry of the experiment for testing the orientation of the eyespot relative to the helical path. The orienting light had a wavelength of 480 nm (1×10^{16} photons $m^{-2} s^{-1}$) and the flash of 550 nm (1×10^{19} photons m^{-2}). (b) Success rate for the detection of a flash reflex from the eyespot as a function of the helical phase angle.

of its photoresponses, i.e., the stop response, which could be identified visually. The stop response is a photophobic reaction exhibited by *Chlamydomonas* at elevated light levels (Schmidt and Eckert, 1976; Hegemann and Bruck, 1989). It occurs in an all-or-nothing fashion when the primary cell depolarization exceeds a critical level (Harz and Hegemann, 1991; Harz et al., 1992), and it consists of an undulation movement of the flagella, which is easily detected under the microscope. Light titrations of this statistical event (Fig. 9 a) showed an orientation-dependent sensitivity. Maximum protection was achieved (Fig. 9 b) when eyespot and light-direction formed an angle similar to the one encountered during oriented swimming, lending further support for the validity of the model. In agreement with microspectrophotometric measurements (Schaller et al., 1997a) the contrast-ratio was maximal (8–10) in the blue/green and very low in the yellow part of the spectrum.

An extended model for phototaxis

We have shown above that a negatively phototactic alga assumes a state of constant, minimal photon absorption

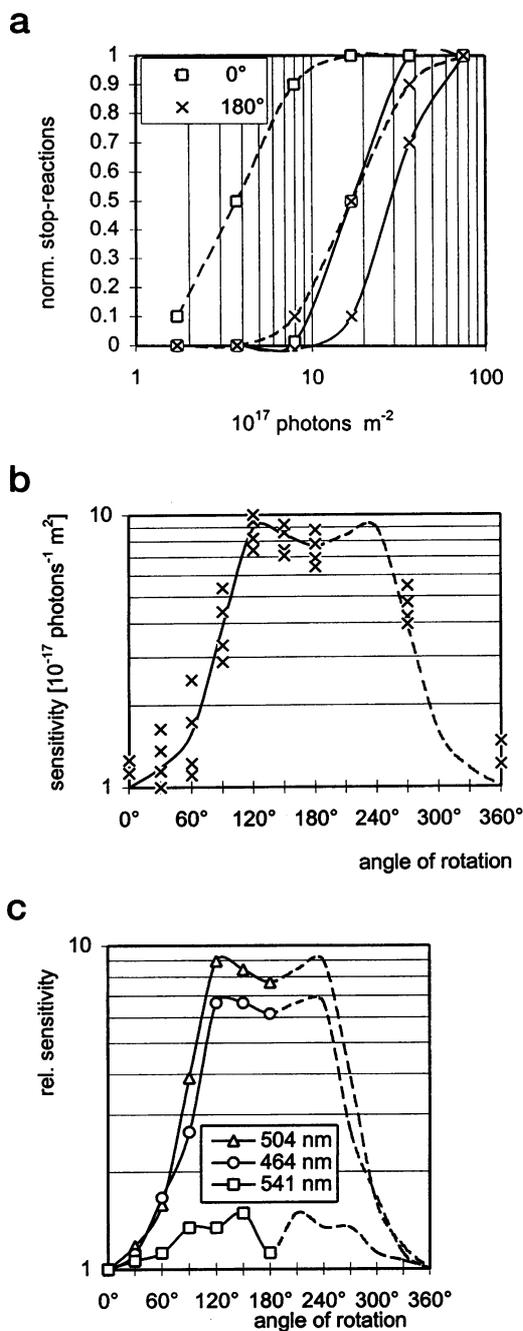

FIGURE 9 (a) Light-titrations of the frequency of stop-responses at two different wavelengths (504 and 541 nm). Solid lines mean that the actinic light hit the eyespot directly (0°) while dotted lines mean that the light had to pass through the cell first before reaching the eyespot (180°). (b) Probability of flash perception (light-sensitivity for stop-response) as a function of the angular orientation of the eyespot. Above 180° only a few control data points were acquired in order to verify that the sensitivity curve is a mirror image of the data taken below 180° . Given the delicacy of the measurement the reproducibility of the 360° value compared to the 0° value is remarkable. The wavelength of the actinic light was 504 nm. (c) Probability of flash perception (light sensitivity for stop-response) as a function of the angular orientation of the eyespot at three different wavelengths (464 nm, 504 nm and 541 nm). In order not to obscure the data only average curves are displayed. The variance was comparable to the one shown in Fig. 9 b.

probability when it is oriented parallel to the light and when it is swimming away from the light source. In order to do so there is only one single requirement to be met: the *trans*-flagellum must beat stronger because only this warrants to an inward/forward orientation of the eyespot. Clearly for a naturally positively phototactic organism it must be the other way round, i.e., the eyespot must point to the outside of the helix and must be tilted backward. This was not shown experimentally, but from the above it should be obvious that the organism has no other chance to keep the eyespot in a shielded position. Generally, in order to maintain a constant orientation and to avoid further direction changes, in positive phototaxis the *cis*-flagellum, and in negative phototaxis the *trans*-flagellum, must dominate. Thus we predict that the discrepancy found in the literature regarding the relative position of the eyespot (for discussion see Kreimer, 1994) can be resolved by assuming that the authors placing the eyespot on the outer side of the helix (Kamiya and Witman, 1984) were observing positive phototaxis while the others (Diehn, 1979; Ruffer and Nultsch, 1987) were viewing negative phototaxis.

The above model may be extended (Fig. 10) so as to explain the switch from positive to negative phototaxis exhibited by wild-type cells. Besides the principles outlined above we only need the finding of Kamiya and Witman (1984) that the internal calcium concentration regulates the beating pattern of the two flagella in a differential way. In darkness the resting calcium concentration is lowest and the *cis*-flagellum beats stronger. The eyespot is hence outward/backward oriented during this time, which we would like to term "phase I." Absorption of a few photons leads to a moderately elevated calcium level and a concomitant dominance of the *trans*-flagellum (phase II). This causes the cell to initiate a turn toward the light, in the course of which the rhodopsins are transiently protected against the light with concomitant drop in internal calcium concentration. This may be viewed as the step-down, which is part of the Ruffer

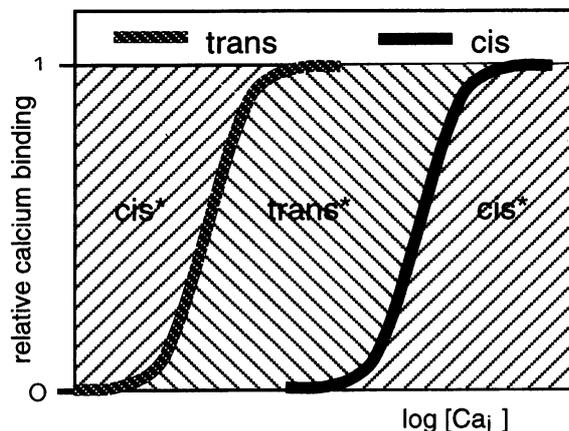

FIGURE 10 Hypothetical model for the switch from positive to negative phototaxis. Shown are a hypothetical calcium binding isotherms for the two flagella and calcium-concentration domains in which the *cis*- respectively *trans*-flagellum is dominating.

and Nultsch model (1991). In any case, it leads to a resumption of the *cis*-flagellum dominance and a return to phase I. As we have pointed out above, *cis*-dominance means that the eyespot faces backward and is thus protected, hence pursuing a path toward the light keeps the eyespot protected and the calcium concentration remains low.

At elevated light levels the cells proceed directly from phase I to phase III, i.e., the internal calcium concentration rises beyond the level where the *trans*-flagellum dominates up to a level where the *cis*-flagellum dominates again. This is no speculation, it merely describes the observation that for negative phototaxis a turn away from the light is required and that invariably necessitates a transient dominance of the *cis*-flagellum. We now propose that higher internal calcium concentrations are required for the *cis*-flagellum to regain its dominance, and these are only reached when the photoreceptors in the eyespot are exposed to the light. As soon as the photoreceptors become protected again, however, which occurs when cell body and eyespot shade the photoreceptors, $[Ca_i]$ returns to a lower level where the *trans*-flagellum dominates again (phase II). This then constitutes a new stable equilibrium state only when the cells pursue a swimming path away from the light. Before this state of stable orientation is reached the cell may carry out one or several turns, i.e., the model predicts the existence of a short trial and error phase in which the cells switch between swimming toward the light or away from it; the shorter this period is, the better the contrast. We have previously described such oscillations between forward and backward swimming (Uhl and Hegemann, 1990b, Fig. 4) and we have noticed that the trial and error phase is negligible when the cells are exposed to blue light (good contrast), but can last for several seconds in yellow light.

Using the above model, how can we envisage a (under normal conditions) purely negatively phototactic organism like strain 806? The easiest explanation would be that the resting calcium concentration in strain 806 is already so high that the *trans*-flagellum dominates in the dark. A further increase in calcium can cause only one reaction, a transient dominance of the *cis*-flagellum, which causes a turn away from the light, and a return to “*trans*-dominating conditions” in the dark or when the photoreceptors are protected. Alternatively one has to assume that the calcium sensitivity of the two flagella is increased in strain 806 such that at resting calcium level II is already reached. Currently we cannot distinguish between the two possibilities.

In an earlier study we have described light adaptation in *Chlamydomonas*. (Uhl and Hegemann, 1990b). When strain 806 cells were light-adapted for extended periods of time, using bright white light, they subsequently showed a transient positive phototactic behavior which decayed with a time course of ~ 1 min. Within the framework of our model this implies that during light adaptation the mechanism by which the cell pumps out calcium was accelerated. Thus, when the adapting light was turned off, $[Ca_i]$ presumably dropped below its normal resting level, now reaching level I, where the *cis*-flagella dominated. This is the requisite for

positive phototaxis. The decay of the positive phototaxis then implies that the internal calcium concentration gradually approached its normal resting level again.

According to the above model phototactic orientation is governed by the orientation-dependent contrast ratio of the eyespot apparatus. In the specimen examined here contrast appears to arise predominantly due to absorbance and only to a minor degree due to reflexion. Moreover, the absorbance due to chlorophylls in the cell body appears to play a greater role than the absorbance due to carotenoids in the eyespot apparatus. This has been concluded before from the fact that eyespot-less mutants can exhibit phototactic behavior (Morel-Laurens and Feinleib, 1983; Sineshchekov et al., 1989). It should be noted, however, that while a contrast ratio of 8–10, as found for *Chlamydomonas* strain 806 at 500 nm and below, leads to optimal orientation, a much smaller contrast of 1.5–2—strain 806 yields this contrast in yellow light (Schaller and Uhl, 1997a)—still leads to some residual orientation which is sufficient for a net directed movement. This explains why even chlorophyll-less mutants can still move phototactically (Kreimer et al., 1992; Kreimer, 1994).

An absolutely necessary requirement for the model is a constant position of the eyespot apparatus relative to the beating plane of the flagella. According to Kreimer (1994), who has studied a great variety of flagellate algae, this appears to be the case, i.e., the eyespot apparatus is always 25–45° outside the flagellar beating plane. There are reports, however, that the eyespot is not always located perfectly on the cell equator (Kreimer, 1994). According to our model a precise location on the equator is optimal for an organism that exhibits both positive and negative phototaxis. A dislocation toward the posterior part of the cell increases the shading for light coming from up-front in an oriented positive phototactic organism, whereas a dislocation toward the anterior part would be counterproductive for positive, but helpful for negative phototaxis. The fact that in strain 806 the eyespot is in most cases in the anterior part, seldom at the equator and even more seldom in the posterior part (Kreimer, personal communication) is taken as further evidence for the validity of the model. Our more physically oriented laboratory is not prepared to test the hypothesis on a great variety of organisms; however, we feel confident that the principles outlined above will turn out to play an important role in the mechanism of phototactic orientation, not only in *Chlamydomonas*.

P. Hegemann's help in earlier stages of the work are gratefully acknowledged. The authors also thank H. Harz and G. Kreimer for critical reading of the manuscript and numerous valuable suggestions.

This work was supported by a grant of the Deutsche Forschungsgemeinschaft.

REFERENCES

- Beck, C. 1996. Lokalisation und Eigenschaften lichtinduzierter Ionenströme in *Chlamydomonas*. Ph.D. Thesis, Ludwig Maximilians Universität, München.

- Beckmann, M., and P. Hegemann. 1991. In vitro identification of rhodopsin in the green alga *Chlamydomonas*. *Biochemistry*. 30:3692–3697.
- Buder, J. 1917. Zur Kenntnis der phototaktischen Richtungsbewegungen. *Jahrbuch wiss. Bot.* 58:105–220.
- Dartnall, H. J. A. 1972. Photosensitivity. In *Photochemistry of Vision. Handbook of Sensory Physiology*, Vol. VII/1. H. J. A. Dartnall, editor. Springer Verlag, Inc., New York. 122–145.
- Deininger, W., P. Kröger, U. Hegemann, F. Lottspeich, and P. Hegemann. 1995. Chlamyrodopsin represents a new type of sensory photoreceptor. *EMBO J.* 14,23:5849–5858.
- Diehn, B. 1979. In *Comparative Physiology and Evolution of Vision in Invertebrates. A. Invertebrate Photoreceptors*. H. Autrum, editor. Springer Verlag, New York. 23–68.
- Feinleib, M. E. 1975. Phototactic response of *Chlamydomonas* to flashes of light. I. Response of cell populations. *Photochem. Photobiol.* 21: 351–354.
- Foster, K. W., J. Saranak, N. Patel, G. Zarilli, M. Okabe, T. Kline, and K. Nakanishi. 1984. A rhodopsin is the functional photoreceptor for phototaxis in the unicellular eukaryote *Chlamydomonas*. *Nature*. 311: 756–759.
- Foster, K. W., and R. D. Smyth. 1980. Light antennas in phototactic algae. *Microbiol. Rev.* 44:572–630.
- Harz, H., and P. Hegemann. 1991. Rhodopsin regulated calcium currents in *Chlamydomonas*. *Nature*. 351:489–491.
- Harz, H., C. Nonnengässer, and P. Hegemann. 1992. The photoreceptor current of the green alga *Chlamydomonas*. *Philos. Trans. R. Soc. Lond. Biol.* 338:39–52.
- Hecht, E. 1974/1987. *Optics*, Addison-Wesley Publishing Company Inc.
- Hecht, S., S. Shlaer, and M. Pirenne. 1942. Energy, quanta and vision. *J. Gen. Physiol.* 25:819–840.
- Hegemann, P., and B. Bruck. 1989. The light-induced stop response in *Chlamydomonas*. Occurrence and adaptation phenomena. *Cell Motil. Cytoskeleton.* 14:501–515.
- Hegemann, P., U. Hegemann, and K. W. Foster. 1988. Reversible bleaching of *Chlamydomonas reinhardtii* rhodopsin in vivo. *Photochem. Photobiol.* 48:123–128.
- Kamiya, R., and G. Witman. 1984. Submicromolar levels of calcium control the balance of beating between the two flagella in demembrated models of *Chlamydomonas*. *J. Cell. Biol.* 98:97–107.
- Kreimer, G. 1994. Cell biology of phototaxis in flagellate algae. *Int. Rev. Cytol.* 148:229–310.
- Kreimer, G., C. Overländer, O. Sineshchekov, H. Stolzis, W. Nultsch, and M. Melkonian. 1992. Functional analysis of the eyespot in *Chlamydomonas reinhardtii* mutant *ey 627, mt⁻*. *Planta*. 188:513–521.
- Kröger, P., and P. Hegemann. 1994. Photophobic responses and phototaxis in *Chlamydomonas* are triggered by a single rhodopsin photoreceptor. *FEBS Lett.* 341:5–9.
- Messler, P., H. Harz, and R. Uhl. 1996. Instrumentation for multiwavelengths excitation imaging. *J. Neurosc. Meth.* 69:137–147.
- Morel-Laurens, N., and M. E. Feinleib. 1983. Photomovement in an “eyeless” mutant of *Chlamydomonas*. *Photochem. Photobiol.* 37: 189–194.
- Naka, K. I., and W. A. H. Rushton. 1966. S-potentials from color units in the retina of fish (*Cyprinidae*). *J. Physiol.* 185:536–555.
- Nultsch, W., G. Throm, and I. v. Rimscha. 1971. Phototaktische Untersuchungen an *Chlamydomonas reinhardtii* Dangeard in homokontinuierlicher Kultur. *Arch. Microbiol.* 80:351–369.
- Pfeffer, W. 1904. Locomotorische Bewegungen und Plasmabeugungen. *Pflanzenphysiologie, Leipzig*. 2:696–828.
- Rüffer, U., and W. Nultsch. 1985. High speed cinematographic analysis of the movement of *Chlamydomonas*. *Cell Motil.* 5:251–263.
- Rüffer, U., and W. Nultsch. 1987. Comparison of the beating of *cis*- and *trans*-flagellula of *Chlamydomonas* cells held on micropipettes. *Cell Motil. Cytoskeleton.* 7:87–93.
- Rüffer, U., and W. Nultsch. 1991. Flagellar photoresponses of *Chlamydomonas* cells held on micropipettes. II. Change in flagellar beat pattern. *Cell Motil. Cytoskeleton.* 18:269–278.
- Schaller, K., and R. Uhl. 1997. A microspectrophotometric study of the shielding properties of eyespot and cell body in *Chlamydomonas*. *Biophys. J.* 73:1573–1578.
- Schmidt, J. A., and R. Eckert. 1976. Calcium couples flagellar reversal to photostimulation in *Chlamydomonas reinhardtii*. *Nature*. 262:713–715.
- Sineshchekov, O., E. Govorunova, and F. Litvin. 1989. Role of photosynthetic apparatus and stigma in the formation of spectral sensitivity of phototaxis in flagellated green algae (Russian with English abstract). *Biofizika.* 34:255–258.
- Smyth, R., J. Saranak, and K. W. Foster. 1988. Algal visual systems and their photoreceptor pigments. *Progr. Phycol. Res.* 6:255–286.
- Takahashi, T., M. Kubota, M. Watanabe, K. Yoshihara, F. Derguini, and K. Nakanishi. 1992. Diversion of sign of phototaxis in a *Chlamydomonas reinhardtii* mutant incorporated with retinal and its analogs. *FEBS Lett.* 314:275–279.
- Uhl, R., H. Desel, and R. Wagner. 1987. Separation and characterization of light scattering transients from rod outer segments of vertebrate photoreceptors: design and performance of a multiangle flash photolysis apparatus (MAFPA). *J. Biochem. Biophys. Meth.* 11:1–14.
- Uhl, R., and P. Hegemann. 1990a. Probing visual transduction in a plant cell. Optical recording of rhodopsin-induced structural changes from *Chlamydomonas*. *Biophys. J.* 58:1295–1302.
- Uhl, R., and P. Hegemann. 1990b. Adaptation of *Chlamydomonas* phototaxis. I. A light scattering apparatus for measuring the phototactic rate of microorganisms with high time resolution. *Cell Motil. Cytoskeleton.* 15:230–244.
- Witman, G. B. 1993. *Chlamydomonas* phototaxis. *Trends Cell Biol.* 11: 403–408.
- Zacks, D., F. Derguini, K. Nakanishi, and J. L. Spudich. 1993. Comparative study of phototactic and photophobic receptor chromophore properties in *Chlamydomonas reinhardtii*. *Biophys. J.* 65:508–518.