

VOLTAGE GAIN OF SIGNAL TRANSFER FROM RETINAL RODS TO BIPOLAR CELLS IN THE TIGER SALAMANDER

BY M. CAPOVILLA, W. A. HARE AND W. G. OWEN

From the Department of Biophysics and Medical Physics, University of California, Berkeley, CA 94720, U.S.A. and the Division of Biology and Medicine, Lawrence Berkeley Laboratory, Berkeley, CA 94720, U.S.A.

(Received 26 August 1986)

SUMMARY

1. Intracellular recordings of the voltage responses of rods and both functional classes of bipolar cell were made in the isolated, perfused retina of the tiger salamander, *Ambystoma tigrinum*.

2. Brief, dim flashes of 519 nm light delivered to the receptive-field centres were used to measure the flash sensitivities of twenty-one on-centre bipolar cells and thirty-six off-centre cells. In each experiment the flash sensitivity of a rod was also measured using diffuse illumination of the same duration and wave-length.

3. The mean flash sensitivity of the rods (fifty-nine cells) was 4.47 mV photon⁻¹ μm² flash. The mean flash sensitivity of the off-centre bipolar cells was 35.4 mV photon⁻¹ μm² flash (thirty-six cells). The mean flash sensitivity of the on-centre bipolar cells was 12.5 mV photon⁻¹ μm² flash.

4. The ratio of the flash sensitivity of the bipolar cell to that of a rod recorded in the same retina defined the gain of voltage transfer from rod to bipolar cell. For signal transfer to on-centre bipolar cells the mean value of the voltage gain was 5.05 ± 1.34 (S.E. of mean). For signal transfer to the off-centre bipolar cells, the mean value of the gain was 10.4 ± 1.29.

5. The on-centre cell gain in the salamander was smaller by a factor of 27 than that of the on-centre cells in the dogfish retina (Ashmore & Falk, 1980*a*), while the off-centre cell gain was comparable in the two species. Possible reasons for the large difference between the voltage gains of on-centre cells in the dogfish and salamander are considered.

INTRODUCTION

Among the many remarkable features of the visual system, its ability, when fully dark-adapted, to signal the absorption of about half a dozen photons (Hecht, Shlaer & Pirenne, 1942) is surely one of the most extraordinary. It requires that each rod be capable of generating a significant response to a single photon absorption and that the rod synapse be capable of faithfully transmitting that signal to the bipolar cell. The mechanisms which allow rods to respond to single photons have been studied extensively in recent years. By contrast, the functional properties of the rod-bipolar cell synapse have been the subject of relatively few reports, possibly because of the difficulty of recording bipolar cell responses.

Most of what is presently known about the transfer of signals from rods to bipolar cells stems from a series of papers by Ashmore & Falk (1977, 1979, 1980*a, b*), in which the responses of on-centre cells in the dogfish, *Scyliorhinus canicula*, were analysed extensively. A key finding was that the estimated voltage gain of signal transfer from rods to on-centre cells is extremely high, the mean estimated value being 135, with individual values as high as 2000. What mechanism could be responsible for this? Ashmore & Falk (1980*a*), argued that the gain should not depend upon the number of rods driving the bipolar cell and suggested that 'some rather more elaborate mechanism of transmitter action than found at many chemical synapses seems to be required'.

In the dogfish, the rods are so slender as to preclude intracellular recording from them and it had therefore been necessary for Ashmore & Falk to estimate the single-photon response of the rods in order to calculate the voltage gain across the synapse. Moreover, it proved difficult to record from off-centre cells in the dogfish, possibly because they are present in much smaller numbers than on-centre cells, and only two estimates of their voltage gain were made. We decided to study signal transfer from rods to bipolar cells in the retina of the tiger salamander, *Ambystoma tigrinum*. This species was chosen because intracellular recording is possible from rods as well as from both classes of bipolar cell. In this paper we report that the voltage gain of signal transfer from rods to on-centre bipolar cells in the salamander is considerably lower than in the dogfish. From rods to off-centre bipolar cells, the gain is comparable with the two values estimated by Ashmore & Falk (1980*a*). Brief accounts of some of these results were given elsewhere (Capovilla, Hare & Owen, 1984; Hare, Capovilla & Owen 1984).

METHODS

Preparation

Larval tiger salamanders, *Ambystoma tigrinum*, were obtained from a commercial supplier (Carl Lowrance, Tulsa, OK, U.S.A.). The animals were kept in a tank at 6 °C on a controlled light-dark cycle. After overnight dark adaptation, salamanders were killed by decapitation and pithing under dim red light. Subsequent dissection was carried out under infra-red illumination ($\lambda > 850$ nm) with the aid of an infra-red image converter attached to a dissecting microscope. Using fine scissors, each eye was enucleated and the cornea and lens dissected away. The eyecup was then placed under oxygenated Ringer solution and the retina gently separated from the retinal pigmented epithelium. A small square of Millipore filter, in the centre of which was a 1.6 mm diameter hole, was slid beneath the retina so that the retina covered the hole, receptor side up. When the filter and retina were raised through the surface of the Ringer solution, the retina flattened and, after carefully blotting the underside of the filter, adhered tightly to it.

The retina, thus mounted, was placed receptor side up in a perfusion chamber where it was perfused with oxygenated Ringer solution (see Fig. 1). The composition of the Ringer solution was (mM): NaCl, 111; KCl, 2.5; CaCl₂, 1.5; MgCl₂, 1.5; glucose, 9; and NaHCO₃, 22, buffered to pH 7.8 by bubbling with a mixture of 95% O₂-5% CO₂.

Micro-electrodes, filled with 4 M-potassium acetate or in some experiments with horseradish peroxidase (HRP) (see below), were introduced from above at an angle of 30 deg to the horizontal. Stimuli were focused, either from above or from below, at the level of the receptor outer segments. Initial alignment of stimulus and electrode was achieved by placing an infra-red transmitting filter in the stimulus beam and viewing the stimulus and electrode with the aid of an infra-red-sensitive video system as indicated.

Stimuli were derived from a two-beam photostimulator similar in design to that used by Copenhagen & Owen (1976). They consisted of circular spots and concentric annuli of chosen intensity, wave-length and duration and could be delivered in any desired sequence. Stimuli could

be moved in two dimensions over the retina in order to centre them upon the receptive field centre of the impaled cell. In the case of a bipolar cell, for example, a dim spot of 500 nm light, 600 μm in diameter, would be moved until it elicited a response of maximum amplitude and monophasic time course. (Decentred stimuli excited the receptive-field surround more strongly and elicited diphasic responses.)

Intracellular responses were recorded on FM tape and subsequently digitized and analysed using a PDP11/03 laboratory computer.

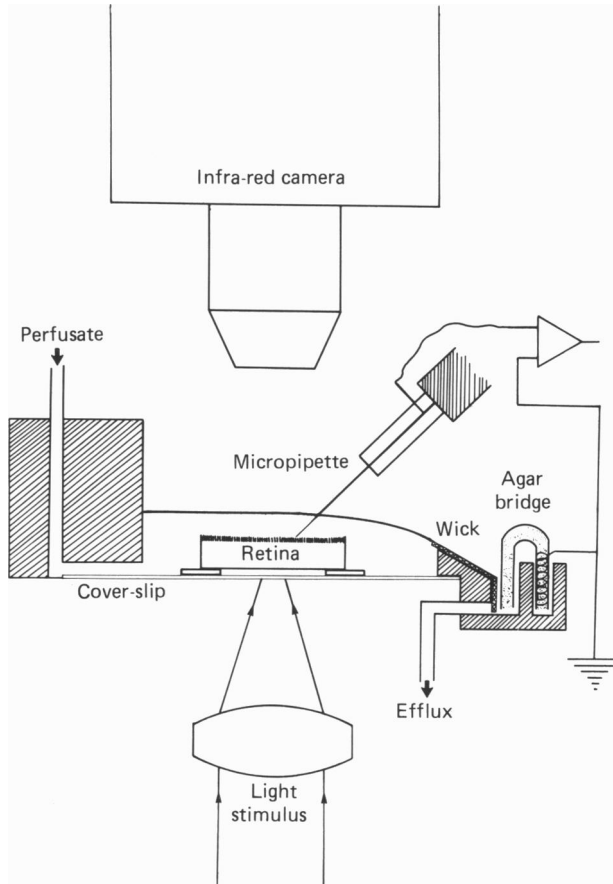

Fig. 1. Schematic diagram of recording apparatus. Stimuli could be delivered from below, as shown, or from above by means of an epi-illumination system. Details are given in the text.

Identification of cells.

Early in this study micro-electrodes were routinely filled with a 1% solution of the enzyme (HRP). After recording voltage responses of a cell, the enzyme was injected ionophoretically. Only one such injection was made in any given retina. The retina was subsequently fixed in 2% glutaraldehyde in 0.1 M-phosphate buffer, rinsed overnight in the buffer and then reacted with 3,3'-diaminobenzidine for 1 h. Subsequent tissue preparation was standard for transmission electron microscopy. After embedding in Epon, the tissue was cut radially into 50 μm sections and examined under the light microscope. In this way the properties of the physiological responses were correlated with cell type. Examples of two bipolar cells, an on-centre and an off-centre cell, are shown in Fig 2. The morphological features of on-centre and off-centre bipolar cells are discussed in detail in another paper (Hare, Lowe & Owen, 1986).

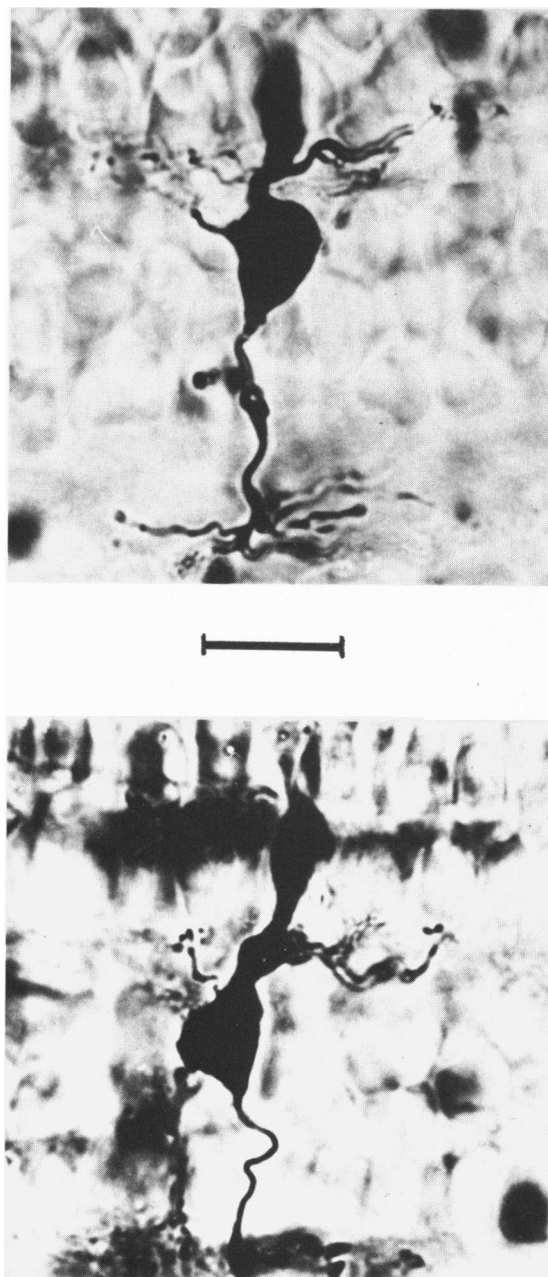

Fig. 2 HRP-injected bipolar cells photographed under the light microscope (bar = 20 μm). The upper one was an on-centre cell while the lower one was an off-centre cell.

Experimental procedure

The gain of signal transfer from rods to bipolar cells can be defined operationally by eqn. (2) (below). To estimate the gain, therefore, requires measurement of the flash sensitivity of both rods and bipolar cells, ideally by recording simultaneously from a bipolar cell and one of the rods that drives it. This was accomplished recently by Wu (1985), using a retinal slice preparation. That approach is not entirely satisfactory, however, because during the slicing procedure a part of the dendritic arborization of the bipolar cell is inevitably lost, the effects of which can only be estimated.

We began by making simultaneous recordings of a rod and a nearby bipolar cell in a conventional isolated retina preparation. Stable recordings from bipolar cells are difficult to obtain under the best of circumstances, however, and we were unable to achieve simultaneous recordings with sufficient frequency for a study of this type. We therefore tested a simpler procedure in which recordings were obtained in sequence from a bipolar cell and a rod. We have never detected any systematic difference between rod sensitivities measured at different times during a given experiment and are confident that this simplification does not diminish the reliability of our measurements. The measured flash sensitivities of the rod and of the bipolar cell were used to calculate the gain of the signal transfer mechanism. This procedure yielded values of the gain which did not differ significantly from those determined from simultaneous recordings and we therefore used it routinely.

Because the measurements we were making required careful dark adaptation, we usually avoided delivering bright stimuli to the retina. When saturating stimuli were delivered, it was generally at the end of an experiment, after all other measurements had been completed. Resting membrane potentials were estimated from the voltage change observed upon withdrawing the electrode from the cell.

Stimulus calibration

Stimulus irradiances were measured in the plane of the retina using an irradiance meter (United Detector Technology, model S351A), and expressed in units of photons $\mu\text{m}^{-2} \text{s}^{-1}$. In order to estimate the number of photopigment molecules bleached in any given rod by a single flash, the irradiance was multiplied by the effective collecting area of the rod and by the flash duration. The outer segments of the rods in the salamander retina average about $9.5 \mu\text{m}$ in diameter and $24 \mu\text{m}$ in length. Assuming an axial photopigment density of $0.011 \mu\text{m}^{-1}$ (Harosi, 1975; Cornwall, MacNichol & Fein, 1984), and a quantum efficiency of bleaching of 0.67 (Dartnall, 1972), the effective collecting area is estimated to be $22 \mu\text{m}^2$. Thus a 20 ms flash of irradiance 1 photon $\mu\text{m}^{-2} \text{s}^{-1}$ is likely to bleach on average 0.44 photopigment molecules in each rod.

Definitions

The flash sensitivity of the rod and the bipolar cell. Following Baylor & Hodgkin (1973), the flash sensitivity (S_F) of a rod is expressed as:

$$S_F = \frac{V_{\text{peak}}}{I_\lambda \Delta t}, \quad (1)$$

as $I_\lambda \Delta t \rightarrow 0$, where V_{peak} is the response amplitude in mV and I_λ is stimulus irradiance in photons $\mu\text{m}^{-2} \text{s}^{-1}$. It is thus expressed in units of mV photon $^{-1} \mu\text{m}^2$ flash. Because the rods are electronically coupled in a syncytium, a diffuse stimulus is used in the measurement of the rod's flash sensitivity to ensure that the full voltage response is developed across the membrane of the impaled cell.

In the case of the bipolar cell the same definition can be used. The measurement of the bipolar cell's flash sensitivity, however, is complicated by the cell's concentrically organized, spatially antagonistic receptive field. In the tiger salamander, a maximal response is elicited by a stimulus that is $600 \mu\text{m}$ in diameter, centred upon the receptive field of the impaled cell (see Results). Larger stimuli activate the receptive-field surround more strongly and smaller, diphasic responses are observed. We therefore measured the flash sensitivities of bipolar cells using centred, $600 \mu\text{m}$ diameter spots of light. For reasons given in the Results, this is likely to lead to an error of no more than 15%.

It should be noted that Ashmore & Falk (1980*a*), expressed the flash sensitivities of dogfish rods in units of mV Rh $^{*-1}$, where Rh* signifies a single photopigment molecule bleached in each and every rod. In effect, this specifies the response amplitude that would be expected if the cell responded linearly to light of a particular intensity: the intensity required to produce, on average,

a single photoisomerization in each rod. This intensity clearly depends upon the effective collecting area of the rod. All other factors being equal, it will be lower in species possessing large rods, like the salamander, than in species possessing slender rods, like the dogfish. By defining the flash sensitivity in terms of incident light, as above, rather than absorbed light, the sensitivities of different species to a given stimulus can be compared directly. To avoid confusion, we shall refer to the quantity defined by Ashmore & Falk (1980*a*) as the photon sensitivity.

The voltage gain of synaptic transfer. The voltage gain of signal transfer from rods to bipolar cells can be defined by the ratio of the peak voltage elicited in the bipolar cell to that elicited in the rod by the same stimulus. With weak stimulation the responses of both rods and bipolar cells are linearly related to stimulus intensity, and the voltage gain, γ , can then be expressed by the ratio of the flash sensitivities:

$$\gamma = \frac{S_{F,\text{bipolar}}}{S_{F,\text{rod}}} \quad (2)$$

This definition is identical to that used by Ashmore & Falk (1980*a*). Note that the factor by which their flash sensitivities will differ from ours, the effective collecting area of the rod, cancels in the expression for gain.

RESULTS

Receptive field organization of bipolar cells

Two functional classes of bipolar cell were identified on the basis of their receptive-field organization. A centred spot of light falling within the receptive-field centre elicited either a depolarization (on-centre cells) or a hyperpolarization (off-centre cells). A concentric annulus of internal diameter greater than 800 μm elicited a response of opposite polarity in each case. Typical recordings from these two classes are presented in Figs. 5 and 6 respectively.

In the case of the off-centre cells, the mean value of the resting membrane potential was -37 ± 2.0 mV (s.e. of mean) and stimuli of saturating intensity elicited responses of 20 ± 2.0 mV (s.e. of mean). In on-centre cells, the mean value of the resting membrane potential was -34 ± 3.4 mV and the mean amplitude of the saturated response was 7 ± 0.7 mV. For comparison, the equivalent values in the rods were -35 ± 1.4 and 27 ± 0.7 mV respectively.

Rod and cone input to bipolar cells

Both on-centre and off-centre bipolar cells were found to receive input from rods and red-sensitive cones (see Figs. 5*A* and 6*A*). Weak flashes of 519 nm light delivered to the receptive-field centres of bipolar cells elicited responses having a time-to-peak of about 600 ms which were well fitted by a single linear function (eqn. (4) below). Weak flashes of 700 nm light could be adjusted to elicit responses of similar amplitude. The times-to-peak of these responses were shorter, however, averaging 380 ms. They could also be fitted by eqn. (4) after adjusting parameters. We take this to indicate that bipolar cells of both classes receive functional input from rods and red-sensitive cones. This is consistent with the anatomical evidence that bipolar cells in this species are in synaptic contact with both rods and cones (Lasansky, 1973). It also implies that, at these low stimulus intensities, each class of input can be effectively isolated by an appropriate choice of stimulus wave-length.

The receptive field surrounds of both classes of bipolar cell also receive input from rods and cones. A dim concentric annulus flashed upon the receptive field surrounds

elicited a response of opposite polarity to the receptive-field centre response. Again the time course of the receptive-field surround response to 700 nm light was much shorter than that of the response to 519 nm light.

The size of the receptive-field centre

Because bipolar cells in tiger salamander retina possess spatially antagonistic receptive fields, diffuse stimuli cannot be used to determine their flash sensitivities. It can be seen in Fig. 3 that the amplitude of the response elicited by a centred, circular stimulus of a given intensity depends critically upon the stimulus diameter.

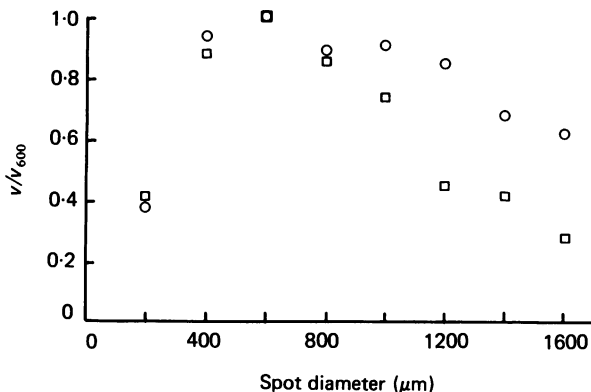

Fig. 3. Typical variation of bipolar cell response amplitude with stimulus diameter for 519 nm stimuli of fixed intensity. Each stimulus was 20 ms in duration and delivered $0.112 \text{ photons } \mu\text{m}^{-2}$ ($2.24 \text{ Rh}^* \text{ rod}^{-1}$) in the case of the on-centre cell and $0.055 \text{ photons } \mu\text{m}^{-2}$ ($1.1 \text{ Rh}^* \text{ rod}^{-1}$) in the case of the off-centre cell. Response amplitudes (V) were normalized against the $600 \mu\text{m}$ diameter value (V_{600}) (2.35 mV for the on-centre cell, 1.1 mV for the off-centre cell). ○, normalized mean of fifteen responses of an on-centre cell; □, normalized mean of fifteen responses of an off-centre cell.

In both on-centre cells and off-centre cells, the largest peak amplitudes were elicited by stimuli of about $600 \mu\text{m}$ diameter. Larger stimuli elicited smaller peak amplitudes because they significantly excited the receptive-field surround. Flash sensitivities were similarly maximal for stimuli of this size. For this reason, the flash sensitivities of the bipolar cells were determined using centred stimuli, $600 \mu\text{m}$ in diameter. The receptive-field surround is likely to be somewhat larger than this. Indeed, preliminary experiments in which the excitatory transmitter antagonist, *cis*-2,3-piperidinedicarboxylic acid (PDA) was used to eliminate the receptive-field surround of the on-centre cell (Slaughter & Miller, 1983) indicate that the receptive-field centre of the on-centre cell may be as much as $900 \mu\text{m}$ in diameter. They further suggest, however, that flash sensitivities measured with stimuli of $600 \mu\text{m}$ diameter are not likely to be in error by more than about 15%.

The flash sensitivity of the rod

Intracellular recordings of rod voltage responses elicited by brief (20 ms) flashes of diffuse 519 nm light were digitized and computer-averaged. The average responses to

the dimmest flashes were fitted with the empirical function (Baylor, Hodgkin & Lamb, 1974):

$$V = A(e^{-at} - e^{-bt})^n, \quad (3)$$

where A is a scaling factor, a and b are rate constants and n is an integer. A typical example of such a fitting is shown in Fig. 4 *A*. In this case, the values of the parameters

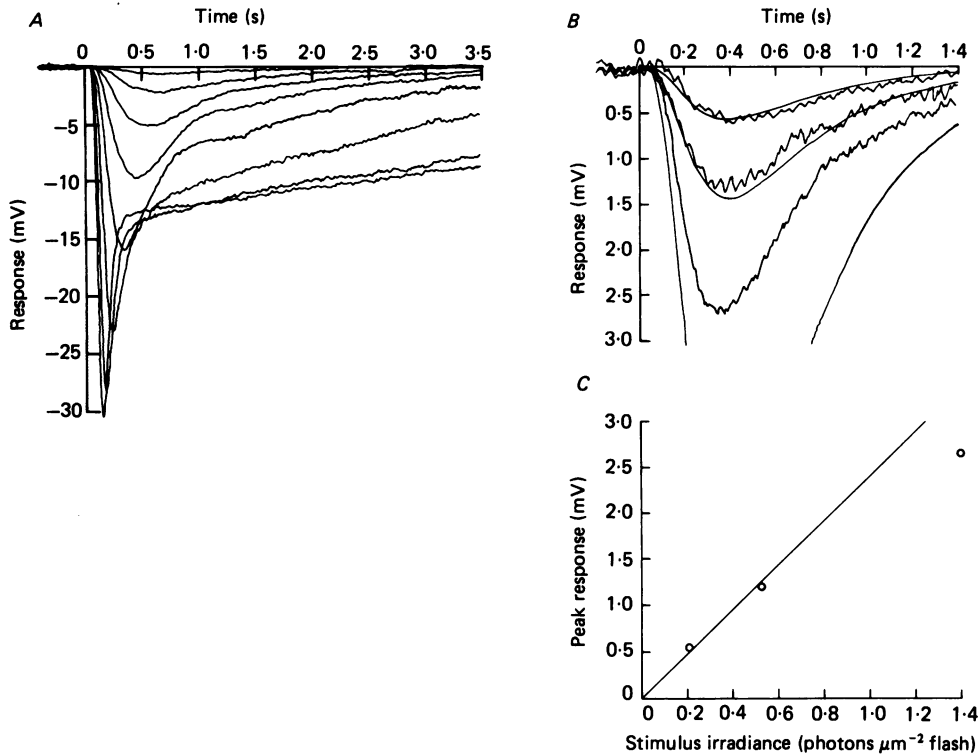

Fig. 4. *A*, typical responses of a rod. Stimuli were 20 ms flashes of diffuse 519 nm light of eight different intensities which produced 2.5–4450 Rh^* per rod. *B*, rod responses elicited by dim 20 ms flashes of 519 nm light of irradiance 0.212, 0.534 and 1.403 photons μm^{-2} flash. The smooth curves were generated by eqn. (3) with $n = 4$, $a = 0.6$, $b = 7$, scaled in proportion to stimulus irradiance. *C*, a plot of peak response amplitude against stimulus irradiance for responses shown in *B*.

were $a = 0.6 \text{ s}^{-1}$, $b = 7 \text{ s}^{-1}$ and $n = 4$. The scaling factor was adjusted to provide a good fit to the smallest response and then increased in proportion to the stimulus intensity. Note that this procedure provided a good fit to the two smallest responses. By definition, these responses are linear since they can be described by an appropriately scaled linear function and thus obey the principle of superposition.

In Fig. 4*C*, the peak amplitudes of the averaged responses are plotted against stimulus intensity. Peak amplitudes of less than about 1.5 mV are proportional to stimulus intensity. The slope of the continuous line through the data points defines the flash sensitivity, S_F , of the rod in $\text{mV photon}^{-1} \mu\text{m}^2 \text{ flash}$. Responses whose peak amplitudes were proportional to stimulus intensity were generally found to be linear

by the more stringent test of superposition (Fig. 4B). Therefore we relied upon this proportionality as an indicator of response linearity during our experiments.

The flash sensitivities of forty rods used in analysing rod-bipolar cell gain are presented in Table 1. The mean value for these cells was $3.55 \text{ mV photon}^{-1} \mu\text{m}^2 \text{ flash}$. The mean value of S_F for all rods from which we recorded (fifty-nine cells) was somewhat higher, being $4.47 \pm 0.24 \text{ mV photon}^{-1} \mu\text{m}^2 \text{ flash}$ (s.e. of mean).

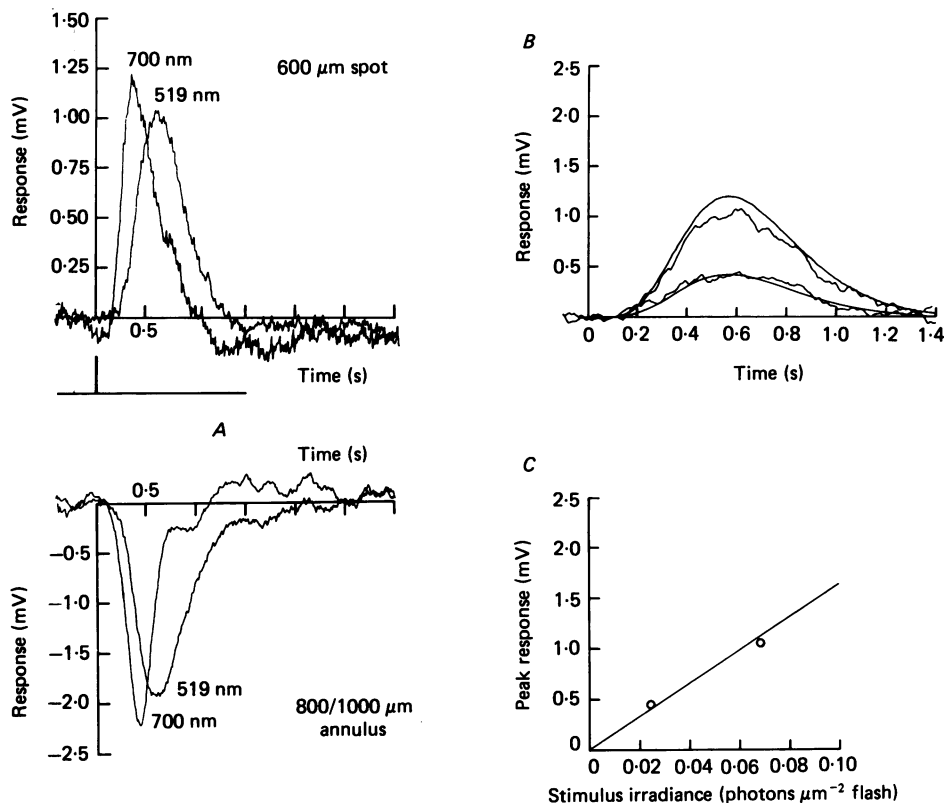

Fig. 5. *A*, responses of an on-centre bipolar cell to weak, 20 ms flashes of light falling within the receptive-field centre (upper panel), and receptive-field surround (lower panel). 519 nm stimuli were of radiance $0.28 \text{ photons } \mu\text{m}^{-2} \text{ flash}$. 700 nm stimuli were of radiance $175 \text{ photons } \mu\text{m}^{-2} \text{ flash}$. Note the faster time course of responses elicited by light of 700 nm which primarily excites the red-sensitive cones. *B*, averaged responses of an on-centre bipolar cell to 20 ms flashes of 519 nm light of irradiance 0.024 and 0.069 photons μm^{-2} flash. Stimuli were 600 μm diameter spots centred within the receptive field. The smooth curves were generated by eqn. (4) with $T_{\text{max}} = 0.57 \text{ s}$ and $n = 6$, scaled in proportion to stimulus irradiance. *C*, a plot of peak response amplitude against stimulus irradiance for the responses shown in *B*.

The flash sensitivity of the bipolar cell

Flash sensitivities of bipolar cells were measured using centred, circular stimuli of 600 μm diameter, 20 ms duration and 519 nm wave-length.

On-centre bipolar cells. The responses of on-centre bipolar cells were analysed in

TABLE 1. Summary of flash sensitivities of twenty-one on-centre bipolar cells, thirty-six off-centre bipolar cells and forty rods used in calculating rod-to-bipolar cell gain. Flash sensitivities are expressed in units of mV photon⁻¹ μm² flash. The values of gain in each case were calculated from the flash sensitivity of the bipolar cell and that of a rod recorded in the same experiment. Mean values of the voltage (±s.e. of mean) are shown for all the cells in each case

On-centre bipolar cells							
Cell no.	S_F	S_F (rod)	Gain	Cell no.	S_F	S_F (rod)	Gain
1	3.84	3.2	1.2	12	5.6	5.6	1.0
2	12.5	1.2	10.4	13	13.4	3.2	4.2
3	8.4	5.6	1.5	14	6.8	2.4	2.8
4	5.36	2.0	2.68	15	17.9	5.6	3.2
5	8.0	3.2	2.5	16	9.12	1.2	7.6
6	11.6	2.4	4.8	17	5.6	5.6	1.0
7	4.56	1.2	3.8	18	52.0	5.2	10.0
8	10.8	4.8	2.25	19	2.04	1.2	1.7
9	7.28	2.0	3.64	20	51.0	1.8	29.0
10	6.84	1.2	5.7	21	1.8	1.7	1.1
11	18.9	3.2	5.9				

Mean 5.05 ± 1.34

Off-centre bipolar cells							
1	4.08	2.4	1.7	19	18.9	0.8	23.6
2	16.2	2.8	5.8	20	37.4	6.4	5.5
3	6.24	4.8	1.3	21	12.1	1.2	10.1
4	4.44	1.2	3.7	22	25.4	2.0	12.7
5	46.6	2.0	23.3	23	161.0	7.2	22.3
6	72.0	8.0	9.0	24	7.36	3.2	2.3
7	17.3	2.4	7.2	25	51.5	5.2	9.9
8	133.0	6.0	22.1	26	48.0	3.2	15.0
9	64.8	4.8	13.5	27	130.0	5.2	25.0
10	20.2	2.4	8.4	28	15.4	2.4	6.4
11	19.8	3.6	5.5	29	75.6	3.6	21.0
12	42.4	2.0	21.2	30	19.3	0.8	24.1
13	9.4	2.0	4.7	31	25.2	2.4	10.5
14	7.92	2.4	3.3	32	9.72	1.2	8.1
15	21.0	1.2	17.5	33	19.7	4.8	4.1
16	5.1	2.4	2.13	34	21.0	4.2	5.0
17	38.9	4.8	4.1	35	19.6	3.2	6.1
18	8.64	4.8	7.1	36	39.8	5.6	7.1

Mean 10.4 ± 1.29

essentially the same way as were the responses of rods. The averaged responses to the weakest stimuli were fitted with the empirical function :

$$V(t) = A \left(\frac{t}{T_{\max}} \right)^{n-1} \exp \left[- (n-1) \left(\frac{t}{T_{\max}} - 1 \right) \right], \quad (4)$$

where T_{\max} is the time-to-peak of the response and n is an integer. This function provided an adequate fit to responses of up to 1.2 mV peak amplitude, simply by adjusting the scaling factor, A , in proportion to stimulus intensity. An example is shown in Fig. 5 *B*. In this case the values of T_{\max} and n were 0.57 s and 6, respectively.

The peak amplitudes of the same responses are plotted against stimulus intensity in Fig. 5C. Again, the slope of the continuous line defines the flash sensitivity of the cell. In experiments on nine on-centre bipolar cells the linear response range extended on average to 1.1 mV.

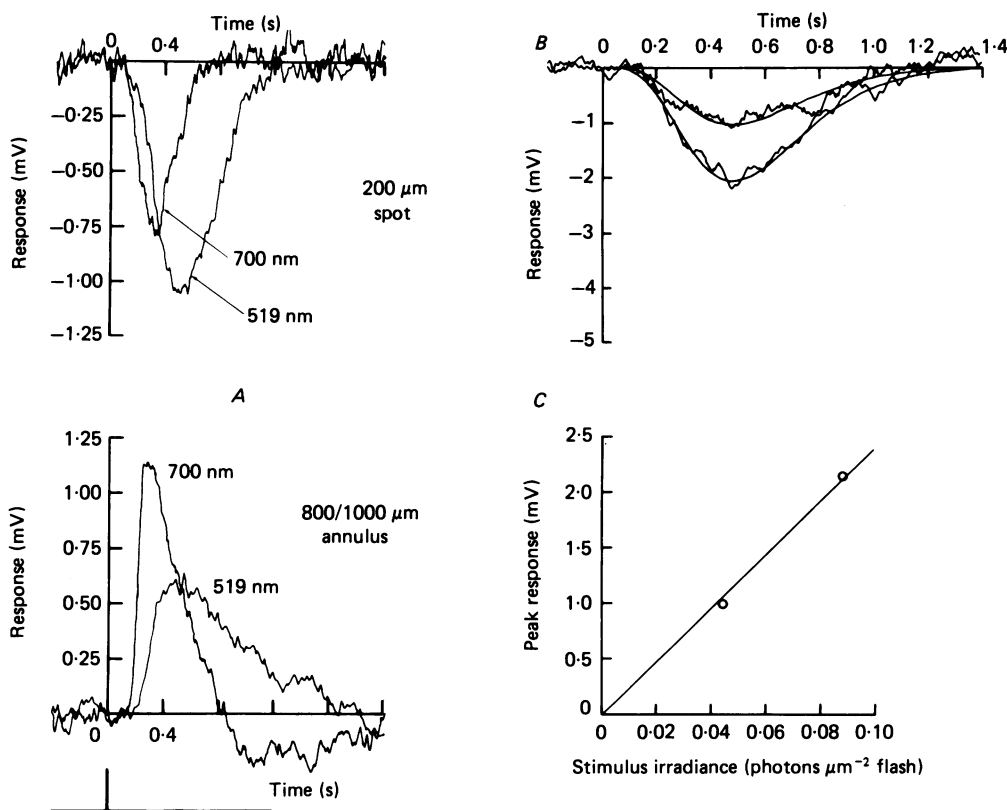

Fig. 6. *A*, responses of an off-centre bipolar cell to weak flashes of light falling within the receptive-field centre (upper panel) and receptive-field surround (lower panel). Light of 700 nm wave-length which primarily excites red-sensitive cones, again elicits faster responses than does 519 nm light. *B*, averaged responses of an off-centre bipolar cell to 20 ms flashes of 519 nm light of irradiance 0.044 and 0.088 photons μm^{-2} flash. Stimuli were 600 μm diameter spots centred within the receptive field. The smooth curves were generated by eqn. (4) with $T_{\text{max}} = 0.48$ s and $n = 5$, scaled in proportion to stimulus irradiance. *C*, a plot of peak response amplitude against stimulus irradiance for the responses shown in *B*.

The flash sensitivities of twenty-one on-centre bipolar cells, determined by this procedure, are presented in Table 1. The mean value was 12.5 ± 3.0 mV photon⁻¹ μm^2 flash (s.e. of mean).

Off-centre bipolar cells. The procedures used in analysing the sensitivity of on-centre cells were applied also to off-centre cells. Again, linear-range responses were fitted with eqn. (4) and it was found that, provided the peak amplitude was no more than 2.5 mV, the value of the scaling factor, A , necessary to achieve a fit was proportional to the stimulus intensity. This is illustrated in Fig. 6*B*. The values of T_{max} and n in this case were 0.48 s and 5, respectively. In Fig. 6*C*, the peak amplitudes

of these same responses are plotted against stimulus intensity, the slope of the continuous line defining the flash sensitivity of the cell. The flash sensitivities of thirty-six off-centre cells analysed in this way are presented in Table 1. The mean value was 35.4 ± 6.3 mV photon⁻¹ μm^2 flash (s.e. of mean).

The gain of signal transfer from rod to bipolar cell

The voltage gains of signal transfer from rods to each of the fifty-seven bipolar cells, estimated as described in the Methods, are presented in Table 1. For transfer to on-centre cells, the mean value of the gain was 5.05 ± 1.34 (s.e. of mean of twenty-one cells). For transfer to off-centre cells the mean gain was 10.4 ± 1.3 (s.e. of mean of thirty-six cells).

DISCUSSION

The responses of rods, elicited by brief flashes of diffuse, 519 nm light, were found to scale linearly with stimulus intensity provided their peak amplitudes did not exceed about 1.5 mV. The mean flash sensitivity measured from linear-range responses of fifty-nine rods can be expressed as a photon sensitivity of 0.203 mV Rh*⁻¹. Thus, the rod responds linearly provided no more than about 7 rhodopsin molecules are bleached by the stimulus.

The responses of bipolar cells also scaled linearly with stimulus intensity provided their peak amplitudes did not exceed 1.2 mV (on-centre cells) or 2.5 mV (off-centre cells). Above these values, response amplitudes grew more slowly as stimulus intensity was increased. Responses of these amplitudes are elicited by stimuli which bleach, on average, 2.1 and 1.7 rhodopsin molecules respectively in each rod. Therefore this departure from linearity begins well within the linear range of the rod response, and probably reflects properties of the signal transfer mechanism.

In all cases the flash sensitivities of bipolar cells in the salamander were found to be higher than those of the rods, indicating that the synaptic transfer mechanism possesses intrinsic gain. The average values of the voltage gain from rods to off-centre cells, defined by eqn. (2), was 10.4. By comparison, in the dogfish the photon sensitivities of the two off-centre cells reported by Ashmore & Falk (1980*a*) suggest voltage gains of 14 and 21, values which are within the range measured in off-centre cells of the salamander.

In the present study the voltage gain from rods to on-centre bipolar cells of the salamander averaged 5.05, slightly higher than was found by Wu (1985) in retinal slices from the same species. By contrast, the gain from rods to on-centre cells in the dogfish averaged 135, with values higher than 500 in some cases. Since the dogfish is the only other species in which voltage gains from rods to bipolar cells have been reported, it is of interest to consider why, in the case of the on-centre cells, the values in these two species should be so different.

The simplest hypothesis, perhaps, is that the properties of the synapses between rods and on-centre cells in the dogfish are very different from those in the salamander. If, as is widely believed, post-synaptic conductance is determined by the rate of release of transmitter, one could suppose that the transmitter release rate of dogfish rods is an unusually steep function of the presynaptic potential and/or that the conductance modulated by transmitter is an unusually steep function of the rate of

transmitter release. Since, however, neither the voltage gain from rods to horizontal cells or that from rods to off-centre bipolar cells is especially large in the dogfish, it would seem more likely that the latter is true, i.e. the high gain reflects a property of the post-synaptic conductance. Falk & Fatt (1974) pointed out that a higher voltage gain may be seen across a synapse at which the effect of transmitter is to close ionic channels than across one at which transmitter opens ionic channels. In the carp, it has been demonstrated that rod transmitter closes ionic channels in the on-centre bipolar cells and opens channels in the off-centre cells (Saito, Kondo & Toyoda, 1979, 1981; Toyoda & Kujiraoka, 1982; Saito & Kaneko, 1983; Kaneko & Saito, 1983). In the dogfish, too, there is good evidence that rod transmitter closes channels in on-centre bipolar cells (Ashmore & Falk, 1980*a*).

An alternative possibility is that the gain of the on-centre cell is strongly dependent upon the number of rods driving it. Ashmore & Falk (1980*a*) argued against this possibility on the grounds that 'increasing the area of the bipolar cell dendritic tree will reduce the single-photon signal in proportion, but will also increase the total number of photons absorbed by the same fraction'. This may well be true when comparing bipolar cells with different dendritic diameters in retinæ having the same rod-population densities, but it need not be true when comparing cells with equal dendritic domains in retinæ having very different rod-population densities, as is the case here. In the dogfish there are roughly 100 000 rods mm⁻² (Witkovsky & Stell, 1973; Ashmore & Falk, 1980*a*), while in the salamander there are only about 3900 rods mm⁻² (Attwell & Wilson, 1980). The dendritic arborizations of bipolar cells in the two species are of similar dimensions, however (Witkovsky & Stell, 1973; Hare *et al.* 1986). If the bipolar cells in the two species contact the same fraction of the rods within their dendritic fields, the bipolar cells in the dogfish will receive input from about 26 times as many rods as those of the salamander. The mean voltage gain in the dogfish is 27 times larger than that measured in the salamander.

The conditions under which the gain might be proportional to the number of rods driving the on-centre bipolar cell can be evaluated by considering the equivalent circuit of the bipolar cell shown in Fig. 7. It is essentially identical to the circuits discussed by Falk & Fatt (1972, 1974) and Ashmore & Falk (1980*a*), and its elements are defined in the Figure legend. The resting potential of the bipolar cell is given by the circuit equation:

$$V_b = \frac{E_r G_r + E_c G_c + E_1 G_1}{G_r + G_c + G_1}. \quad (5)$$

The voltage gain of signal transfer from rod to bipolar cell is then:

$$\frac{dV_b}{dV_r} = \frac{(E_r - V_b)}{(G_r + G_c + G_1)} \frac{dG_r}{dV_r}, \quad (6)$$

where V_r is the membrane potential at the rod's synaptic terminal. If the post-synaptic conductance modulated by each of the n rods driving the bipolar cell has an average value of g_r in darkness, then $G_r = ng_r$ and eqn. (6) becomes:

$$\frac{dV_b}{dV_r} = \frac{(E_r - V_b)}{(ng_r + G_c + G_1)} n \frac{dg_r}{dV_r}. \quad (6a)$$

It can be seen from eqn. (6a) that the voltage gain is proportional to n provided (1) $G_r (= ng_r)$ is negligibly small in darkness, (2) G_c and G_1 are independent of n , (3) g_r is independent of n .

If conditions (2) and (3) are met, therefore, the critical factor which determines

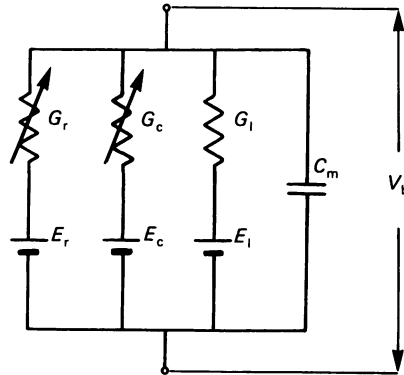

Fig. 7. Equivalent electrical circuit of the bipolar cell. G_r is the conductance modulated by transmitter released from rods and E_r is its associated e.m.f. G_c is the conductance modulated by cone transmitter and E_c the associated e.m.f. G_1 and E_1 are the lumped equivalents of all other conductances and e.m.f.s respectively. C_m is the membrane capacitance. Implicit in this model is the assumption that distributed conductances contribute equally to the total membrane conductance of the bipolar cell and, hence, that the cell is isopotential.

whether or not the voltage gain of the bipolar cell is proportional to n is the size of G_r relative to $G_c + G_1$ in darkness. If we now examine the ionic mechanisms underlying the responses of off-centre and on-centre bipolar cells, we see that they lead to different expectations concerning the voltage gain in each case.

The rods release transmitter at a high rate in darkness, the effect of light being to reduce that rate. In off-centre bipolar cells, where transmitter is thought to open post-synaptic channels (see above), $G_r (= ng_r)$ is unlikely to be particularly small in darkness, and the gain will not, in general, be proportional to n . In the limit, in which $G_r \gg G_c + G_1$, the gain is independent of n , provided condition (3) above is also met.

In on-centre cells, on the other hand, transmitter is believed to close post-synaptic channels (see above), and it is therefore quite possible that G_r is small in darkness, perhaps small enough, compared with $G_c + G_1$, to be neglected. If that is the case, the gain of voltage transfer from rods to on-centre bipolar cells will be proportional to n , provided conditions (2) and (3) above are met. It is worth noting that even if G_r is not negligibly small, eqn. (6a) implies that the gain will increase as n increases, although not in direct proportion, provided $G_r \lesssim G_c + G_1$ and conditions (2) and (3) are met.

As an explanation of the results from the salamander and dogfish, this idea is attractive because it does not require that the properties of the synapses in either species be in any way unusual. The unexpectedly high gain of voltage transfer between rods and on-centre bipolar cells in the dogfish, otherwise so puzzling, becomes a simple consequence of the high degree of convergence of rods onto the bipolar cells in that species.

We wish to thank Janet Lowe and William James Meecham for their expert technical assistance. We are grateful to Denis Baylor, David Copenhagen, Peter McNaughton and Paul Witkovsky for critically reading earlier versions of the manuscript. This project is supported by research grant EYO3785 from the National Institutes of Health (to W.G.O.). M.C. was in receipt of a Senior Fulbright Fellowship. W. A. H. was supported by a Post-doctoral Fellowship (EYO5374) from the National Eye Institute.

REFERENCES

- ASHMORE, J. F. & FALK, G. (1977). Dark noise in retinal bipolar cells and the stability of rhodopsin in rods. *Nature* **270**, 69–71.
- ASHMORE, J. E. & FALK, G. (1979). Transmission of rod signals to bipolar cells near absolute threshold. *Vision Research* **19**, 419–423.
- ASHMORE, J. E. & FALK, G. (1980a). Responses of rod bipolar cells in the dark adapted retina of the dogfish, *Scyliorhinus canicula*. *Journal of Physiology* **300**, 115–150.
- ASHMORE, J. E. & FALK, G. (1980b). An analysis of voltage noise in rod bipolar cells of the dogfish retina. *Journal of Physiology* **332**, 273–297.
- ATTWELL, D. & WILSON, M. (1980). Behaviour of the rod network in the tiger salamander retina mediated by membrane properties of individual rods. *Journal of Physiology* **309**, 287–315.
- BAYLOR, D. A. & HODGKIN, A. L. (1973). Detection and resolution of visual stimuli by turtle photoreceptors. *Journal of Physiology* **234**, 163–198.
- BAYLOR, D. A., HODGKIN, A. L. & LAMB, T. D. (1974). Reconstruction of the electrical responses of turtle cones to flashes and steps of light. *Journal of Physiology* **288**, 613–634.
- CAPOVILLA, M., HARE, W. A. & OWEN, W. G. (1984). Voltage gain across the rod/bipolar cell synapse in the salamander, *Ambystoma tigrinum*. *Investigative Ophthalmology and Visual Science* **25**, 237.
- COPENHAGEN, D. R. & OWEN, W. G. (1976). Functional characteristics of lateral interactions between rods in the retina of the snapping turtle. *Journal of Physiology* **259**, 251–282.
- CORNWALL, M. C., MACNICHOL, E. F. & FEIN, A. (1984). Absorbance and spectral sensitivity measurements of rod photoreceptors of the tiger salamander, *Ambystoma tigrinum*. *Vision Research* **24**, 1651–1659.
- DARTNALL, H. J. A. (1972). Photosensitivity. In *Photochemistry of Vision, Handbook of Sensory Physiology*, vol. VII/1, ed. DARTNALL, H. J. A., pp. 122–145. New York: Springer-Verlag.
- FALK, G. & FATT, P. (1972). Physical changes induced by light in the rod outer segment of vertebrates. In *Handbook of Sensory Physiology*, vol. VII/1, ed. DARTNALL, H. J. A. Heidelberg: Springer-Verlag.
- FALK, G. & FATT, P. (1974). The dynamic voltage-transfer function for rod–bipolar cell transmission. *Vision Research* **14**, 739–741.
- HARE, W. A., CAPOVILLA, M. & OWEN, W. G. (1984). Functional properties of histologically identified bipolar cells in the salamander retina. *Investigative Ophthalmology and Visual Science* **25**, 237.
- HARE, W. A., LOWE, J. S. & OWEN, W. G. (1986). The morphology of physiologically identified bipolar cells in the retina of the tiger salamander, *Ambystoma tigrinum*. *Journal of Comparative Neurology* **252**, 130–138.
- HAROSI, F. I. (1975). Absorption spectra and linear dichroism of some amphibian photoreceptors. *Journal of General Physiology* **66**, 357–382.
- HECHT, S., SHLAER, S. & PIRENNE, M. H. (1942). Energy, quanta and vision. *Journal of General Physiology* **25**, 819–840.
- KANEKO, A. & SAITO, T. (1983). Ionic mechanisms underlying the responses of off-center bipolar cells in the carp retina. II. Studies on responses evoked by transretinal current stimulation. *Journal of General Physiology* **81**, 603–612.
- LASANSKY, A. (1973). Organization of the outer synaptic layer in the retina of the larval tiger salamander. *Philosophical Transactions of the Royal Society B* **265**, 471–489.
- SAITO, T. & KANEKO, A. (1983). Ionic mechanisms underlying the responses of off-centre bipolar cells in the carp retina. I. Studies on responses evoked by light. *Journal of General Physiology* **81**, 589–601.
- SAITO, T., KONDO, H. & TOYODA, J. (1979). Ionic mechanisms of two types of on-centre bipolar

- cells in the carp retina. I. The responses to central illumination. *Journal of General Physiology* **73**, 73–90.
- SAITO, T., KONDO, H. & TOYODA, J. (1981). Ionic mechanisms of two types of on-center bipolar cells in the carp retina. II. The responses to annular illumination. *Journal of General Physiology* **78**, 569–589.
- SLAUGHTER, M. M. & MILLER, R. F. (1983). An excitatory amino acid antagonist blocks cone input to sign-conserving second-order retinal neurons. *Science* **219**, 1230–1232.
- TOYODA, J. & KUJIRAOKA, T. (1982). Analyses of bipolar cell responses elicited by polarization of horizontal cells. *Journal of General Physiology* **79**, 131–145.
- WITKOVSKY, P. & STELL, W. K. (1973). Retinal structure of the smooth dogfish, *Mustelus canis*; light microscopy of bipolar cells. *Journal of Comparative Neurology* **150**, 147–168.
- WU, S. M. (1985). Synaptic transmission from rods to bipolar cells in the tiger salamander retina. *Proceedings of the National Academy of Sciences of the U.S.A.* **82**, 3944–3947.