

**EFFECTS OF L-GLUTAMATE ON THE ANOMALOUS
RECTIFIER POTASSIUM CURRENT IN HORIZONTAL CELLS OF
CARASSIUS AURATUS RETINA**

BY AKIMICHI KANEKO AND MASAO TACHIBANA*

*From the Department of Information Physiology, National Institute for Physiological
Sciences, Okazaki, 444 Japan*

(Received 27 April 1984)

SUMMARY

1. The effects of externally applied L-glutamate (Glu) on K currents through the anomalous rectifier were studied in solitary horizontal cells dissociated from goldfish retinae under whole-cell voltage-clamp or cell-attached patch-clamp conditions using 'giga-seal' suction pipettes.

2. In the whole-cell clamp experiments, hyperpolarization of the membrane below the resting potential (*ca.* -57 mV) induced a large voltage-dependent inward current which has been identified as the K current through the anomalous rectifier ($I_{\text{anomal.}}$). Application of Glu to the external medium reduced $I_{\text{anomal.}}$. Reduction of the inward current was not seen in preparations in which $I_{\text{anomal.}}$ has been blocked by an application of Cs or Ba ions to the external medium.

3. Single-channel currents through the anomalous rectifier were recorded under cell-attached patch-clamp conditions. The current showed an inward rectification; its amplitude increased with hyperpolarization of the patch membrane, and became below the noise level near the equilibrium potential of K ions (E_{K}). No polarity reversal was observed even by a strong membrane depolarization. The patch membrane potential at which the current amplitude became undetectable shifted in parallel to the shift of E_{K} . The open probability changed little with polarization of the patch membrane.

4. When Glu (>100 μM) was applied to the outside of the patch membrane, the number of available $I_{\text{anomal.}}$ channels was decreased, but neither the single-channel conductance, open or closed time constants, nor the open probability changed significantly. Removal of Glu produced the opposite sequence; i.e. the number of available $I_{\text{anomal.}}$ channels increased with time.

5. It was concluded that the reduction of the Glu-induced current at hyperpolarized potentials in the whole-cell recording configuration is due to the blocking action of Glu on $I_{\text{anomal.}}$.

* To whom reprint requests should be addressed.

INTRODUCTION

In the preceding paper (Tachibana, 1985), it has been demonstrated that L-glutamate (Glu) induces two types of conductance change in a solitary horizontal cell of the goldfish retina. First, Glu increases a conductance to cations which generates an inward current and depolarizes horizontal cells in the resting state (Ishida, Kaneko & Tachibana, 1984). Secondly, Glu has been shown to suppress a voltage-dependent membrane conductance. The Glu-induced net current (I_{Glu}), which increases in amplitude with membrane hyperpolarization below the reversal potential of the first component (*ca.* -3 mV in 118 mM-extracellular Na ions), decreases in amplitude with further hyperpolarization below the resting membrane potential. Solitary horizontal cells have four kinds of voltage-dependent conductance; a Ca current and three kinds of K current (Tachibana, 1983). When all the voltage-dependent conductances were blocked by externally applied pharmacological agents (TEA, Cs, 4-aminopyridine (4-AP) and 0 Ca), the reduction of I_{Glu} disappeared and I_{Glu} increased monotonically in amplitude with membrane hyperpolarization.

Since the current activated by membrane hyperpolarization in horizontal cells has been identified as the K current through the anomalous rectifier ($I_{\text{anomal.}}$) (Tachibana, 1983), it was suggested that the voltage-dependent conductance which was affected by Glu was $I_{\text{anomal.}}$. In the present study, the above hypothesis was examined under whole-cell voltage-clamp conditions and patch-clamp conditions. Some of the results have been presented at the Annual Meeting of the Neuroscience Society of Japan (Tachibana & Kaneko, 1984).

METHODS

Preparations, superfusates and methods of recording in the whole-cell clamp configuration are the same as in the preceding paper (Tachibana, 1985). Only methods of single-channel recording and of data processing will be described in detail.

Single-channel currents were recorded with similar suction pipette electrodes to those used for the whole-cell recording. Pipettes were filled either with a standard pipette solution or with the same solution supplemented with various concentrations of Glu. The composition of the standard solution was 120 mM-KCl, 2.5 mM-CaCl₂ and 5 mM-HEPES, and the pH was adjusted to 7.5 with KOH (final concentration 4 mM). A special pipette holder was designed (Fig. 1) to enable an exchange of the pipette solution while recording single-channel currents. The pipette (G), filled with the standard solution at the beginning of recording, was connected to a small glass bottle (*ca.* 2 ml) by a piece of silicone tube (S) and made air-tight by filling the junction with epoxy resin (E). A thin polyethylene tube (P) filled with the standard solution was inserted into the recording pipette. The opposite end of the tube was immersed in a small reservoir (R) filled with a test solution. A Ag-AgCl wire (W) made an electrical contact between the pipette solution and the input stage of the pre-amplifier. To exchange the pipette solution, a negative pressure (*ca.* 300 mmH₂O) was applied to the bottle (B). Usually the test solution was coloured red-pink by the addition of 0.001 % (w/v) phenol red (as a pH indicator). The standard solution was not coloured. Successful change in the pipette solution was signalled by a change in the colour of the drop of solution flowing into the reservoir bottle. In some experiments, the pipette was first filled with the test solution and washed with the standard solution.

The effective change of the pipette solution was verified by examining the blocking effect of Ba ions on single $I_{\text{anomal.}}$ (Hagiwara, Miyazaki, Moody & Patlak, 1978). In this test, the occurrence of the open state of single $I_{\text{anomal.}}$ was dramatically reduced about 2 min after the application of negative pressure. The time lag is likely to be that needed for introduction of the test solution

from the reservoir to the tip of the thin polyethylene tube and diffusion of the test solution from the tip of the tube to the tip of the recording pipette.

The recording pipette was connected to a current-voltage (I - V) converter (List Electronic, Darmstadt, F.R.G., EPC-5). The output signal from the I - V converter was filtered through a 48 dB/octave low-pass filter (NF circuit design block Inc., Yokohama, Japan, FV-625A) at a cut-off frequency of 1 kHz. Signals were displayed on a chart recorder (Graphtec Inc., Tokyo, Japan, WR3101, 0-120 Hz, +5%, -10%) and real-time sampled on-line at 2 kHz by a 12-bit A/D converter (AD11-K) connected to a computer (PDP 11/34). Sampled data were analysed off-line.

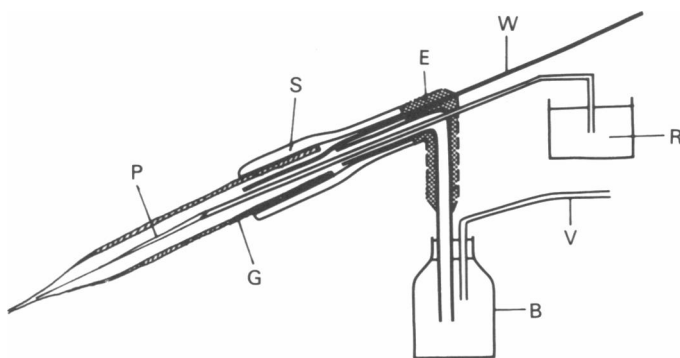

Fig. 1. Diagram of a suction pipette holder for intrapipette perfusion. The tip of a thin polyethylene tube (P) is placed within 300 μm from the tip of the recording pipette (G). S, a silicone tube; E, epoxy resin; W, a Ag-AgCl wire; R, a reservoir filled with a test solution; B, a glass bottle; V, a tube connected to a negative pressure. For clarity the scales of parts are modified.

In the membrane patches which contained only one ionic channel, the record was analysed by the following method. First, an amplitude histogram was constructed for a duration of approximately 120 s. If the record had a stable base line and a good signal-to-noise ratio, the peaks of the amplitude histogram were clearly separated from each other. A threshold level was set at the valley of this histogram, and the state at which the current was larger in amplitude than the threshold was defined as the open state of the channel. The state at which the current was smaller than the threshold was defined as the closed state. The duration of each open and closed state was calculated and displayed in the open or closed time histogram. When a large number (>100) of events were accumulated, the envelope of the histogram was smoothly fitted with a single-exponential curve, and from this curve time constants of open or closed events were calculated. Usually, the time bin for the open state was set at 20 ms, and that for the closed state at 1 ms. Even with time bins this short, it was necessary to sample the data for at least 2 min to accumulate enough events to calculate the time constants. It was not practical to obtain time constants for slower events, because it was difficult to maintain a stable recording for the long period of time required.

In the membrane patches which contained a large number (greater than three) of channels, the effect of Glu on single-channel currents was detected by two methods: the amplitude histogram mentioned above and the amount of charge carried across the patch membrane. The latter was calculated for every 1 s by integrating the recorded current and displayed against the time scale.

RESULTS

Identification of the voltage-dependent conductance affected by Glu

In the whole-cell clamp experiments, application of 100 μM -Glu to solitary horizontal cells bathed in the control solution evoked an inward current (Fig. 2A), which is carried by a mixture of cations (Tachibana, 1985). The amount of inward

current increased when the cell membrane was hyperpolarized from the reversal potential (-12 mV) of this current up to *ca.* -50 mV. However, further hyperpolarization caused a reduction of this inward current (Fig. 2*B*, filled circles). In thirty-two out of 206 cells strong hyperpolarization reversed the polarity of the Glu-induced current (I_{Glu}) from inward to outward at membrane potentials somewhere between -70 and -95 mV (not illustrated, but see Fig. 3 of the preceding paper,

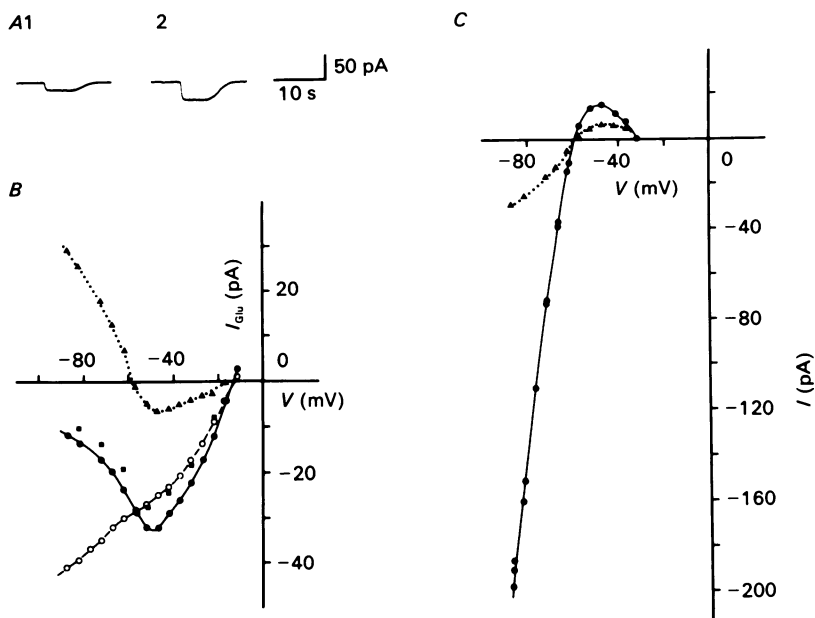

Fig. 2. The effect of Cs ions on the Glu-induced current. Currents were recorded under the whole-cell clamp condition. A solitary horizontal cell was superfused with the control solution (in mM: NaCl, 81; KCl, 10; CaCl_2 , 2.5; MgCl_2 , 1; choline Cl, 37; HEPES, 2; glucose, 16) or with the Cs solution (10 mM-CsCl replaced choline Cl, and the other constituents were the same as the control solution), and $100 \mu\text{M}$ -Glu was pressure applied. A, I_{Glu} in the control (A1) or in the Cs (A2) solution. The cell was held at -72 mV. Current traces are arbitrarily shifted. Inward currents are shown as downward deflexions. B, $I_{\text{Glu}}-V$ relations in the control solution (filled circles) and in the Cs solution (open circles). The effect of Cs ions was reversible (filled squares). The Cs-sensitive component of I_{Glu} is plotted as filled triangles. C, the $I-V$ relation of the anomalous rectifier and that of the Cs-sensitive component replotted from B with the current polarity reversed.

Tachibana, 1985). Since the reduction of I_{Glu} by membrane hyperpolarization disappeared when all the voltage-dependent conductances of solitary horizontal cells were blocked by an application of pharmacological agents (TEA, Cs, 4-AP and 0 Ca) to the external medium (see Fig. 4 of the preceding paper, Tachibana, 1985), it was proposed that this phenomenon is caused by a blocking effect of Glu on some voltage-dependent ion channels.

It was suggested that the affected ionic current is that through the anomalous rectifier, since this is the only voltage-dependent ionic current in solitary horizontal cells activated by membrane hyperpolarization. The experiment of Fig. 2 was made

to verify this hypothesis. When the anomalous rectifier was blocked either by 10 mM-Cs ions (Fig. 2B, open circles) or by 1 mM-Ba ions (not illustrated), the voltage-dependent reduction of I_{Glu} disappeared. Under this condition I_{Glu} measured at -72 mV (Fig. 2A2) was larger in amplitude than that measured in the control solution (Fig. 2A1). In the presence of Cs ions, I_{Glu} increased in amplitude monotonically as the membrane potential was hyperpolarized from ca. -12 mV. The Cs-sensitive component of I_{Glu} was isolated (filled triangles) as the difference between the pair of I_{Glu} measured

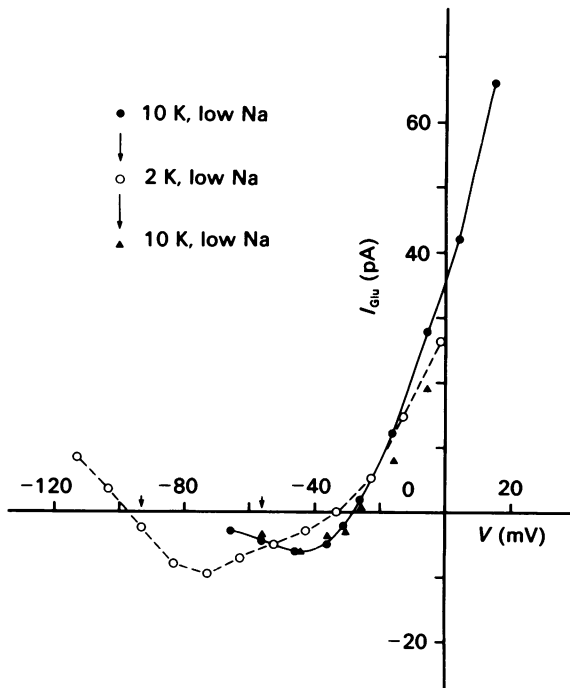

Fig. 3. The effect of extracellular K ions on I_{Glu} . I_{Glu} was measured when a solitary horizontal cell was bathed in the control solution (10 mM-K ions) or in the test solution containing 2 mM-K ions. The holding potential was set at the resting membrane potential in each solution (-56 mV in the control solution and -93 mV in the test solution; arrows) and command pulses of various intensities were applied. Glu ($100 \mu\text{M}$) was pressure applied in the whole-cell recording configuration.

in the Cs solution (open circles) and in the control solution (filled circles). The isolated component was outward at < -60 mV, inward at potentials between -60 and -12 mV, and almost disappeared at > -12 mV.

The Cs-sensitive I_{Glu} isolated in Fig. 2B is replotted with its polarity reversed, together with the I - V relation of I_{anomal} recorded from the same cell in the control solution (Fig. 2C). The I - V relation of the Cs-sensitive I_{Glu} was similar to that of the K current through the anomalous rectifier, although the former was smaller in amplitude.

Activation of I_{anomal} is known to depend strongly on the driving force of K ions ($V - E_{\text{K}}$) (Hagiwara & Takahashi, 1974; Tachibana, 1983). The Cs-sensitive I_{Glu} also

showed similar dependence on the driving force of K ions. In the solution containing 2 mM-K ions the reduction of inward I_{Glu} was seen at a more hyperpolarized potential level than in 10 mM-K ion solution (Fig. 3). The potential at which the reduction of inward I_{Glu} began to appear shifted by -41.5 ± 4.5 mV ($n = 6$). On the other hand, in the 40 mM-K ion solution the potential shifted to more depolarized potential level by $+30.3 \pm 0.8$ mV ($n = 6$) (cf. Fig. 9 of the preceding paper, Tachibana, 1985). These potential shifts were close to those of E_{K} estimated from the Nernst equation (-40.5 mV and $+34.9$ mV, respectively).

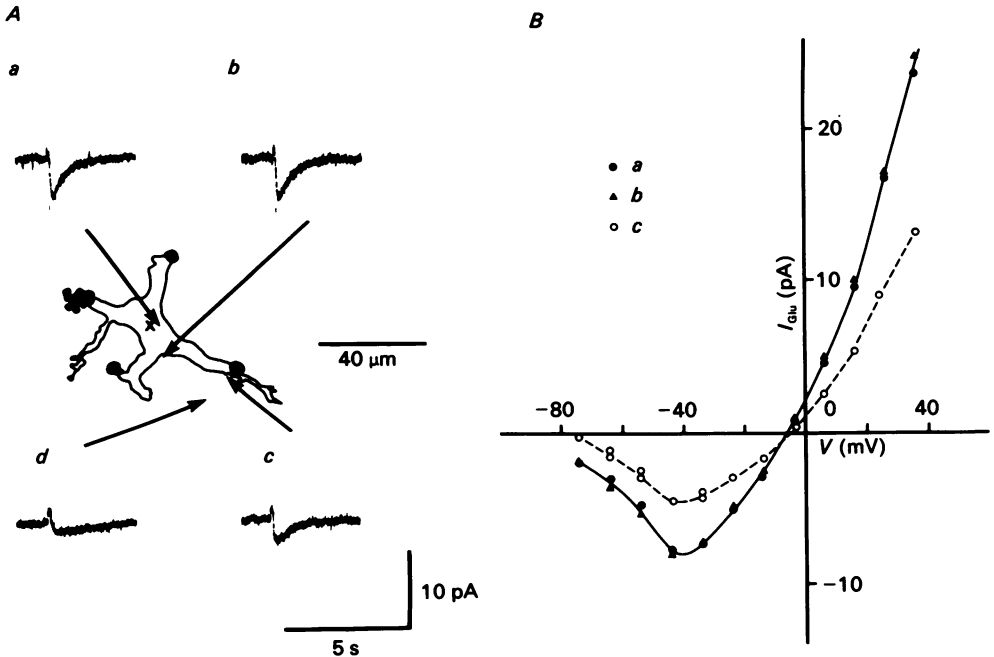

Fig. 4. Effects of Glu locally applied by ionophoresis. *A*, current traces recorded under the whole-cell clamp condition. A solitary horizontal cell was superfused with the control solution and held at -54 mV. A Glu-containing pipette was positioned at places shown by arrows and Glu was applied by 100 ms current pulses (-30 nA). The mark \times indicates the position of the recording pipette. Shaded parts of the trace of the cell indicate attached debris. *B*, the $I_{\text{Glu}}-V$ relation obtained when the drug pipette was placed at point *a* (near the recording pipette), point *b* (at a rim of the cell body) or point *c* (near a dendritic tip), as shown in *A*.

Two kinds of interpretation might be possible theoretically to account for the reduction in the inward I_{Glu} by membrane hyperpolarization below *ca.* -50 mV; a generation of an outward current or a reduction in the inward current. However, it is very difficult to imagine a current which flows outward at potentials more negative than -60 mV, since E_{K} (*ca.* -60 mV) is expected to have the most negative value among the equilibrium potentials of ions in the control solution. Together with the pieces of evidence shown above, the reduction in the inward I_{Glu} was identified as a suppression of $I_{\text{anomalous}}$, i.e. a Glu-induced conductance decrease to K ions.

The inward I_{Glu} was always maximum in amplitude at a potential (*ca.* -50 mV)

more positive than E_K in the control solution (Figs. 2B, 3 and 4B). In this region of membrane potential, $I_{\text{anomal.}}$ flows outward. Application of Glu caused a reduction of the outward $I_{\text{anomal.}}$, which was added to the inward I_{Glu} through the Glu-activated channels and produced a net increase.

The reduction of the inward I_{Glu} was clearly observed at $30 \mu\text{M-Glu}$, and maximum reduction was induced by $> 100 \mu\text{M-Glu}$.

When $I_{\text{anomal.}}$ is activated, the input resistance of the cell markedly decreases. It might be argued that the reduction in I_{Glu} by membrane hyperpolarization was an artifact due to an incomplete space clamp of the recorded cell, and that the disappearance of I_{Glu} reduction after an application of Cs was the result of recovery of a high input resistance due to the inactivation of $I_{\text{anomal.}}$. However, this possibility was rejected by an experiment illustrated in Fig. 4. In this experiment the recording electrode was positioned at the centre of the cell body (marked with \times) and Glu was ionophoretically applied at four different sites (*a-d*). Position *a* was only a few micrometres away from the recording pipette, while position *c* was near the tip of a long process where the space clamp would be much less perfect. However, as shown in Fig. 4B, I_{Glu} recorded at these two largely separated positions showed a similar voltage-dependent reduction, and the membrane potentials at which the reduction began to appear were almost identical.

In mouse central neurones, it has been demonstrated that a reduction of I_{Glu} by membrane hyperpolarization is due to a voltage-dependent blockage of Glu-activated channels by Mg ions (Nowak, Bregestovski, Asher, Hervet & Prochiantz, 1984). However, in solitary horizontal cells, withdrawal of Mg ions from the superfusate caused no significant change in the reduction of I_{Glu} (see Fig. 5 of the preceding paper, Tachibana, 1985).

Single $I_{\text{anomal.}}$ channel of solitary horizontal cells

When a 'giga-seal' was established between the recording pipette and the cell membrane, pulse-like currents of the order of 1 pA were recorded in almost all membrane patches of solitary horizontal cells (Fig. 5A). In this Figure, the lower level indicates the zero current, so the current flowed inward (upward deflexion) almost steadily with brief interruptions. The transition at the onset and offset of current was rapid, and was limited by the frequency characteristics of the amplifier and the cut-off filter. The amplitude of the pulse-like current was constant within the limit of the noise of the recording system. Hyperpolarization of the patch membrane increased the current amplitude, while depolarization decreased the current amplitude. No reversal of the current polarity was seen.

The small pulse-like current under observation was identified as single $I_{\text{anomal.}}$ from the following properties. (1) Since the pipette solution contained mainly KCl, it is likely that the current was carried by K ions. (2) The current has a strong inward rectification similar to that seen with $I_{\text{anomal.}}$ recorded in the whole-cell configuration. (3) The current was activated by membrane hyperpolarization below zero. Since K ion concentration on both sides of the patch membrane was nearly equal (the pipette solution contained 124 mM-K ions), E_K across the patch membrane was estimated to be close to zero. (4) The amplitude of the current depended on the K ion concentration of the pipette solution, and a larger amplitude of the current was seen at higher K

ion concentration (Fig. 5B). The I - V relation of this current also shifted with K ion concentration of the pipette, and the extrapolated I - V curves crossed the abscissa at approximate E_K values. (5) The current flowed for more than 90% of the time and this open probability did not change significantly during a prolonged polarization of the patch membrane. The K current through the anomalous rectifier of solitary horizontal cells shows little inactivation (Tachibana, 1983). (6) The current was blocked by Ba ions (see Methods).

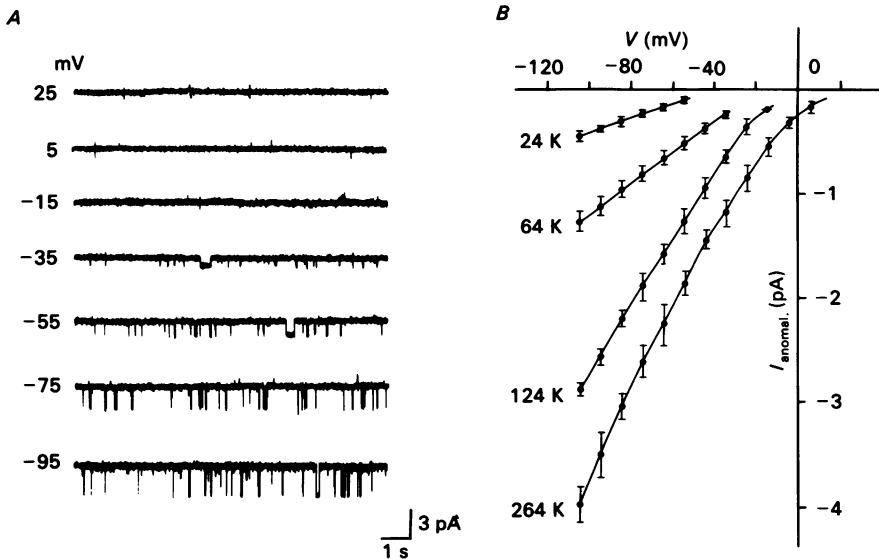

Fig. 5. Currents through a single anomalous rectifier channel. *A*, single $I_{\text{anomal.}}$ channel activities under patch-clamp conditions. A solitary horizontal cell was superfused with the control solution. A suction pipette was filled with the standard pipette solution (124 mM-K ions). Upward deflexions of current traces indicate the state when the channel is open and the current flows inward. Potentials of the patch membrane are shown on the left side of each current trace. Current traces are arbitrarily shifted. *B*, relations between the single-channel current and the patch membrane potential, which were obtained using suction pipettes filled with solutions containing various concentrations of K ions. The K ion concentrations are shown on the left side of curves (in mM). In the 24 mM-K and 64 mM-K solutions, K ions were replaced with an equimolar amount of choline⁺, but in the 264 mM-K solution (hyperosmolarity) KCl was simply added to the standard pipette solution (124 mM-K). In each pipette solution, data were collected from four patch membranes and the means and standard deviations of the current amplitudes are plotted. Note that the single-channel conductance rectifies near E_K values (124 and 264 mM-K).

Usually the current amplitude was either zero or one particular value, but it took two or more states when pipettes with large tip diameters were used. The current amplitude of such membrane patches was two or three times that of the smallest amplitude, but in a few instances the current amplitude took some intermediate values (cf. Kameyama, Kiyosue & Soejima, 1983).

Effect of Glu on single $I_{\text{anomal.}}$ channels

Application of Glu to the outside of the patch membrane reduced the number of effective $I_{\text{anomal.}}$ channels (Fig. 6). Fig. 6A illustrates approximately 3 s sample

records taken *a*, 0.5 min, *b*, 4.5 min and *c*, 9 min after the pipette solution was switched from the standard solution to that containing 1 mM-Glu. Fig. 6*B* shows the amplitude histograms compiled from records sampled for 30 s at around the times *a*, *b* and *c* as indicated in Fig. 6*C*. Scales on the abscissae indicate the number of open channels. When the outside of the patch membrane was exposed to the standard solution, the number of channels was maximally seven. All of these channels were identified as I_{anomal} channels from the criteria described above. Because of transition of each channel, the number of open channels varied between seven and 2.5 (including an intermediate state or a rim channel; cf. Neher, Sakmann & Steinbach, 1978) with

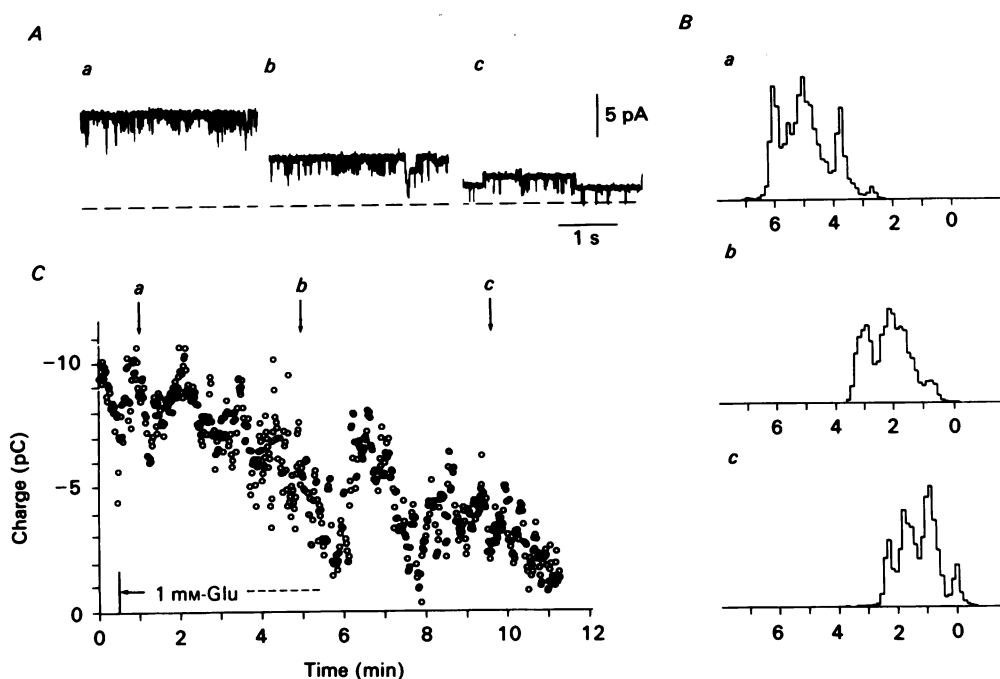

Fig. 6. The effect of Glu on single anomalous rectifier channel currents. The pipette solution was exchanged from the standard to the 1 mM-Glu-containing solution by an intrapipette perfusion technique. Both solutions contained 124 mM-K ions. The recorded cell was superfused with the control solution (10 mM-K ions) and the patch membrane was held at -60 mV. *A*, current recordings obtained *a*, 0.5, *b*, 4.5 and *c*, 9 min after the pipette solution was switched to the Glu-containing solution. The dashed line indicates the level of 0 pA. Inward currents are shown as upward deflexions. *B*, amplitude histograms compiled from records at around the times *a*, *b* and *c*. Abscissae indicate the number of channels. *C*, the amount of charge moved across the patch membrane through I_{anomal} channels.

a high probability of 3.5, five and six open states. At about 4.5 min after the application of Glu, the number of open channels decreased to one to three, with the highest probability of two open states. At about 9 min after Glu application, a significant probability was observed for the state in which all channels were in the closed state.

Although each channel fluctuated between the open and closed states, reduction of $I_{\text{anomal.}}$ was further demonstrated by calculating the amount of charge carried across the patch membrane through $I_{\text{anomal.}}$ channels (Fig. 6C). The amount of charge before and after Glu application differed significantly. Similar results were obtained from seven other membrane patches.

Fig. 7 illustrates a similar experiment to that of Fig. 6, but the pipette solution was switched in the reversed sequence. Here, the single $I_{\text{anomal.}}$ was recorded first in the presence of 1 mM-Glu in the pipette solution. In the presence of Glu, the number

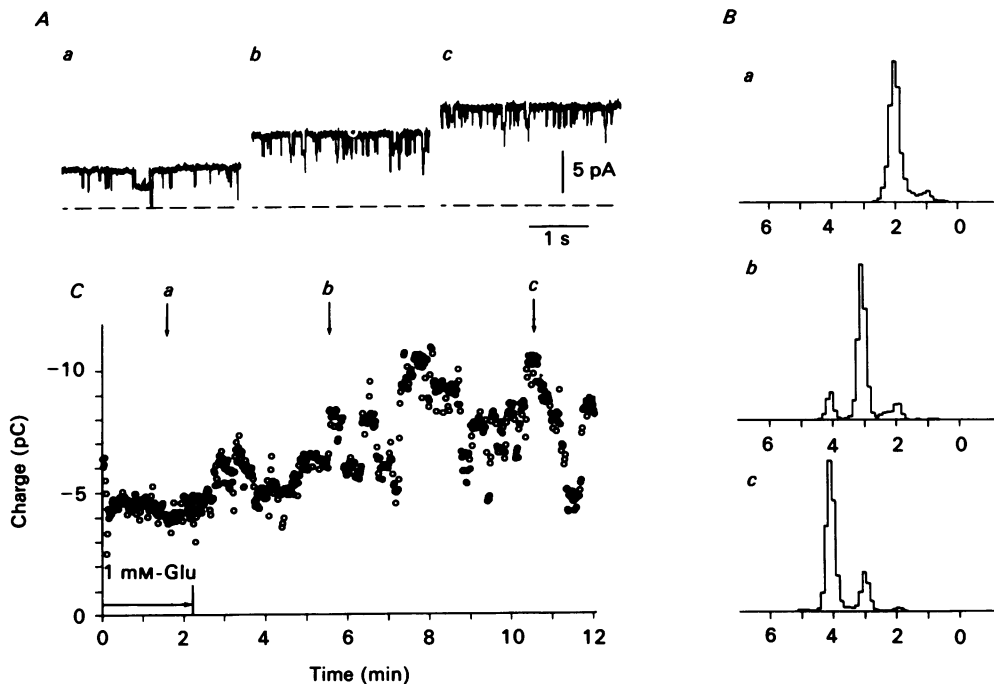

Fig. 7. The effect of Glu on the anomalous rectifier channels. Single $I_{\text{anomal.}}$ was recorded first in the presence of 1 mM-Glu in the pipette solution, and then the solution was exchanged for the standard pipette solution by an intrapipette perfusion technique. A solitary horizontal cell was bathed in the control solution and the patch membrane was held at -80 mV. *A*, current records. The dashed line indicates the level of 0 pA. *a*, *b* and *c* correspond to the times indicated in *C*. *B*, amplitude histograms. Abscissae indicate the number of channels. *C*, the amount of charge moved across the patch membrane through the anomalous rectifier channels.

of $I_{\text{anomal.}}$ channels was maximally two and the number of open states fluctuated between two and zero. As Glu in the recording pipette was washed out, the maximum number of channels increased to four (at time *b*), and finally to five (at time *c*). The increase in the number of effective channels is reflected in the amount of charge moved across the patch membrane (Fig. 7C). Similar results were observed in sixteen other membrane patches.

Glu affected neither the amplitude (Fig. 8A), the open probability (Fig. 8B), nor the time constants (Fig. 8C) of anomalous rectifier channels. The cell shown in Fig. 8

was one of six records in which only one channel was seen in the presence of Glu and two or three channels were observed after the wash-out of Glu. When two or three I_{anomal} channels were recorded, the mean open probabilities of these channels were calculated with an assumption that the closed states of more than one channel would not overlap. Since the probability of the closed state of any single channel remained less than 10%, the overlap was estimated to be less than 1%. Therefore, in the

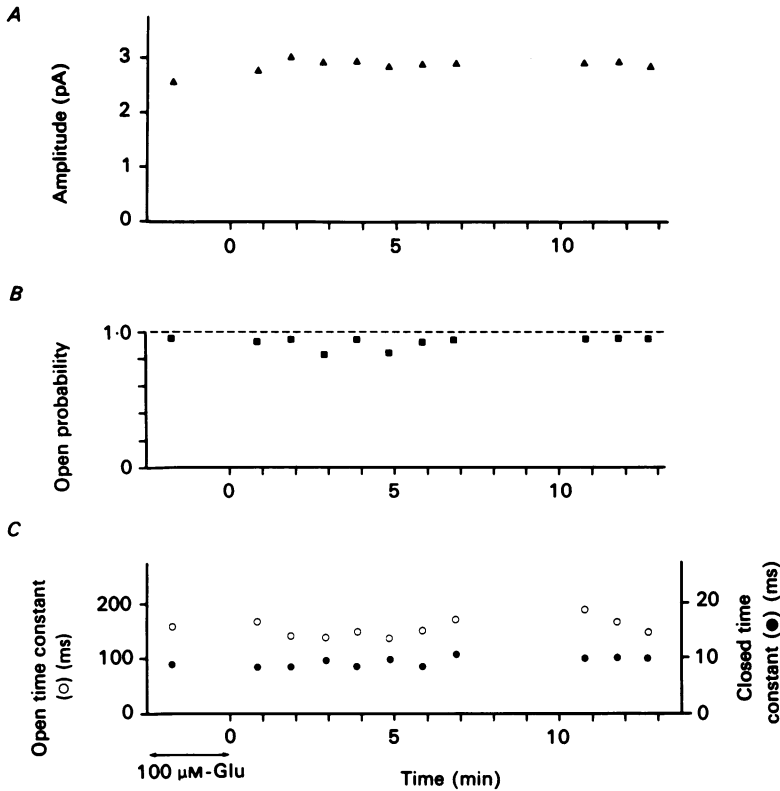

Fig. 8. The effects of Glu on *A*, the amplitude, *B*, the mean open probability and *C*, the time constants of open (open circles) and closed (filled circles) events of the single I_{anomal} . A solitary horizontal cell was bathed in the control solution and single I_{anomal} was recorded by a suction pipette which was first filled with the solution containing 100 μM -Glu and then exchanged for the standard pipette solution. Only one channel was observed in the presence of Glu and another channel appeared after the wash-out of Glu. The patch membrane was held at -80 mV.

membrane patch which contained a maximum of n channels, the mean closed probability of one channel is $p(\text{cl})/n$, and the mean open probability $p(o)$ is

$$p(o) = 1 - p(\text{cl})/n.$$

The estimated open probability remained above 90% in all membrane patches. Furthermore, neither the open nor the closed probability within the examined time range was affected by Glu.

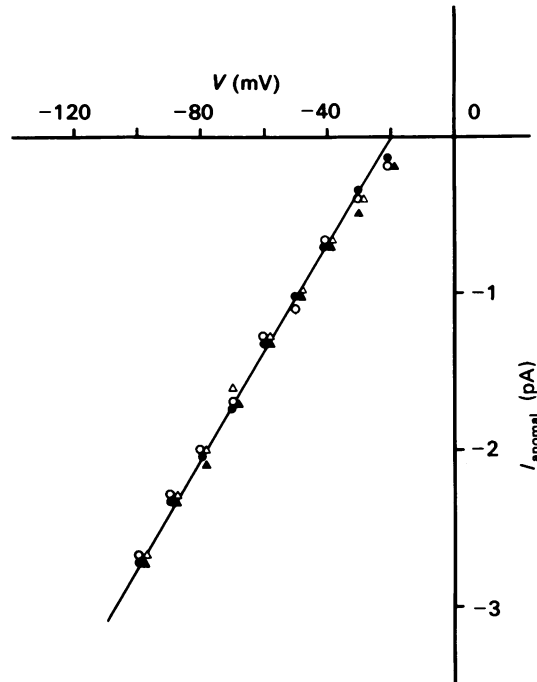

Fig. 9. Single-channel conductance of the anomalous rectifier in the presence (open symbols) or absence (filled symbols) of $100 \mu\text{M}$ -Glu. Data were obtained from two patch membranes (indicated as circles and triangles). The slope of the line corresponds to 30 pS . The pipette solution contained 124 mM-K ions.

The single-channel conductance of $I_{\text{anomal.}}$ was the same in the presence or absence of Glu (Fig. 9). In this example, the I - V curve of single $I_{\text{anomal.}}$ was fitted with a line, and the channel conductance was estimated as the slope of this line. The conductance was 30 pS under both conditions.

DISCUSSION

Peculiar voltage-dependence of the Glu-induced response (a reduction of the response amplitude at hyperpolarized potentials) has been reported in various preparations, and it has been suggested that Glu suppresses a K conductance (Freeman, 1976; Shapovalov, Shiriaev & Velumian, 1978; Engberg, Flatman & Lambert, 1979). The present studies demonstrated that the K current through the anomalous rectifier was blocked by Glu in solitary horizontal cells. Recently, it has been shown in mouse central neurones that the Glu-activated channels are blocked by Mg ions at hyperpolarized potentials (Nowak *et al.* 1984). However, this was not seen in solitary horizontal cells.

Glu seems to have a direct action on the $I_{\text{anomal.}}$ channels, since its effect was seen when applied extracellularly to patch membranes. If the effect was induced via some internal messenger, an application of Glu to such a limited area would not be detected. In this respect, Glu resembles Cs and Ba ions. However, there are some differences

in blocking properties between Glu and these ions. (1) The effect of Glu on the anomalous rectifier channels was to decrease the available number of channels without changing either the single-channel conductance or the time constants of the open and closed states. This can be explained either by a real decrease in the number of channels or by the introduction of a new blocked state with a long time constant, which was too long to detect in the present experiments. In the latter case, the time constant of the blocked state is expected to be much slower than that by Cs or Ba ions (T. Kurahashi, A. Kaneko & M. Tachibana, unpublished data; cf. Kameyama *et al.* 1983). (2) The blocking effect of Glu became weak at strongly hyperpolarized potentials; 30–40% of the activated $I_{\text{anomalous}}$ was suppressed by Glu near the resting membrane potential but 15–20% at strongly hyperpolarized potentials (< -80 mV). On the other hand, the blocking effect of Cs or Ba ions becomes prominent with stronger hyperpolarization (Hagiwara, Miyazaki & Rosenthal, 1976; Hagiwara *et al.* 1978). (3) Glu blocked $I_{\text{anomalous}}$ only weakly even at high concentrations (> 100 μM), while Cs and Ba ions are very effective at doses of tens of micromolar.

The anomalous rectifier channels in solitary horizontal cells showed similar properties to those of other preparations: (1) the single-channel conductance rectifies; (2) the conductance is a function of the driving force of K ions ($V - E_{\text{K}}$); and (3) the conductance depends on the extracellular K ion concentration. However, the single-channel conductance of solitary horizontal cells in 125 mM-K ions was approximately 30 pS, which is smaller than that of rabbit ventricular cells (50 pS in 150 mM-K ions; Kameyama *et al.* 1983) and much larger than that of tunicate eggs (5 pS in 100 mM-K ions; Fukushima, 1982) and rat myotubes (10 pS in 155 mM-K ions; Ohmori, Yoshida & Hagiwara, 1981) even when the differences in K ion concentration and temperature are considered. Furthermore, the mean open probability of the channels of solitary horizontal cells shows little voltage dependence, while that of other preparations decreases strongly with membrane hyperpolarization and voltage-dependent inactivation is prominent (cf. Kameyama *et al.* 1983).

In solitary horizontal cells, the anomalous rectifier channels were diffusely distributed over the cell membrane and were most frequently observed among other ion channels. The single-channel current was about 0.03 pA (i) and the mean open probability ($p(o)$) was *ca.* 0.95 when the membrane potential was hyperpolarized by 10 mV from E_{K} in 10 mM-K ions. The total current through the whole cell membrane under the corresponding condition was approximately 100 pA (I). The total number of anomalous rectifier channels (N) is calculated from the following equation,

$$N = I/p(o)i,$$

and is estimated to be 3500 channels in a solitary horizontal cell. A rough estimation of the surface area of the cell is 2000 μm^2 , thus the density of the anomalous rectifier is approximately 2 channels/ μm^2 . This value fits very well to the observation that two or three anomalous rectifier channels were most frequently seen in each patch membrane, the area of which was approximately 1 μm^2 .

The physiological significance of the blocking effect of Glu on the anomalous rectifier is puzzling. If the transmitter released from photoreceptors has similar effects to Glu, and if signal transmission from photoreceptors to horizontal cells occurs only at synapses, the transmitter would not affect the anomalous rectifier which is

distributed over the whole cell membrane. It seems of interest to examine in *in vivo* preparations whether the transmitter released from photoreceptors is localized within synaptic clefts or spreads over the horizontal cell membrane.

We thank Mr Takashi Kurahashi for his contribution at an early stage of patch-clamp experiments and Miss Michi Hosono for her excellent technical assistance. This work is supported by Grants in Aid from the Ministry of Education, Science and Culture (Nos. 58480177, 58870015 and 58106008) to A. K. and Professor Kato Memorial Research Fund for Physiology and Medicine to M. T.

REFERENCES

- ENGBERG, I., FLATMAN, J. A. & LAMBERT, J. D. C. (1979). The actions of excitatory amino acids on motoneurons in the feline spinal cord. *Journal of Physiology* **288**, 227–261.
- FREEMAN, A. R. (1976). Studies of an excitatory neurotransmitter: Synaptic and nonsynaptic interactions of L-glutamic acid. In *Electrobiology of Nerve, Synapse, and Muscle*, ed. REUBEN, J. P., PURPURA, D. P., BENNETT, M. V. L. & KANDEL, E. R., pp. 61–80. New York: Raven Press.
- FUKUSHIMA, Y. (1982). Blocking kinetics of the anomalous potassium rectifier of tunicate egg studied by single channel recording. *Journal of Physiology* **331**, 311–331.
- HAGIWARA, S., MIYAZAKI, S., MOODY, W. & PATLAK, J. (1978). Blocking effects of barium and hydrogen ions on the potassium current during anomalous rectification in the starfish egg. *Journal of Physiology* **279**, 167–185.
- HAGIWARA, S., MIYAZAKI, S. & ROSENTHAL, N. P. (1976). Potassium current and the effect of cesium on this current during anomalous rectification of the egg cell membrane of a starfish. *Journal of General Physiology* **67**, 621–638.
- HAGIWARA, S. & TAKAHASHI, K. (1974). The anomalous rectification and cation selectivity of the membrane of a starfish egg cell. *Journal of Membrane Biology* **18**, 61–80.
- ISHIDA, A. T., KANEKO, A. & TACHIBANA, M. (1984). Responses of solitary retinal horizontal cells from *Carassius auratus* to L-glutamate and related amino acids. *Journal of Physiology* **348**, 255–270.
- KAMEYAMA, M., KIYOSUE, T. & SOEJIMA, M. (1983). Single channel analysis of the inward rectifier K current in the rabbit ventricular cells. *Japanese Journal of Physiology* **33**, 1039–1056.
- NEHER, E., SAKMANN, B. & STEINBACH, J. H. (1978). The extracellular patch clamp: A method for resolving currents through individual open channels in biological membranes. *Pflügers Archiv* **375**, 219–228.
- NOWAK, L., BREGESTOVSKI, P., ASCHER, P., HERBET, A. & PROCHIANTZ, A. (1984). Magnesium gates glutamate-activated channels in mouse central neurones. *Nature* **307**, 462–465.
- OHMORI, H., YOSHIDA, S. & HAGIWARA, S. (1981). Single K⁺ channel currents of anomalous rectification in cultured rat myotubes. *Proceedings of the National Academy of Sciences of the U.S.A., Biological Sciences* **78**, 4960–4964.
- SHAPOVALOV, A. I., SHIRIAEV, B. I. & VELUMIAN, A. A. (1978). Mechanisms of post-synaptic excitation in amphibian motoneurons. *Journal of Physiology* **279**, 437–455.
- TACHIBANA, M. (1983). Ionic currents of solitary horizontal cells isolated from goldfish retina. *Journal of Physiology* **345**, 329–351.
- TACHIBANA, M. (1985). Permeability changes induced by L-glutamate in solitary retinal horizontal cells isolated from *Carassius auratus*. *Journal of Physiology* **358**, 153–167.
- TACHIBANA, M. & KANEKO, A. (1984). The blocking effect of L-glutamate on the anomalous rectifier K channels of solitary horizontal cells from *Carassius auratus*. *Abstracts of the Seventh Annual Meeting of the Japan Neuroscience Society. Neuroscience Letters* (in the Press).