

# Ability of methotrexate to inhibit translocation to the cytosol of dihydrofolate reductase fused to diphtheria toxin

Olav KLINGENBERG and Sjur OLSNES

Institute for Cancer Research at the Norwegian Radium Hospital, Montebello, 0310 Oslo, Norway

A fusion protein consisting of dihydrofolate reductase and diphtheria toxin A-fragment was made by genetically linking cDNA for the two proteins followed by *in vitro* transcription and translation in a rabbit reticulocyte lysate system. The dihydrofolate reductase in the fusion protein exhibited enzyme activity and, in the presence of methotrexate which imposes a tight structure on dihydrofolate reductase, it was trypsin resistant, indicating that it was correctly folded. When reconstituted with diphtheria toxin B-fragment, it bound specifically to diphtheria toxin receptors and was translocated into cells upon exposure to

low pH. Methotrexate prevented the translocation. Protein synthesis was inhibited in cells incubated with the reconstituted fusion protein, but the inhibition was reduced in the presence of methotrexate. We also made a fusion protein containing a mutated dihydrofolate reductase with much lower affinity to methotrexate. Methotrexate did not prevent translocation of this protein. The data indicate that methotrexate prevents translocation of the fusion protein containing wild-type dihydrofolate reductase by imposing a tight structure on to the enzyme.

## INTRODUCTION

Diphtheria toxin (DT) acts by translocating to the cytosol an enzymically active protein which ADP-ribosylates elongation factor 2 and blocks protein synthesis [1]. The toxin is synthesized and secreted by lysogenic strains of *Corynebacterium diphtheriae* as a single polypeptide chain with a disulphide-bridged loop that is very sensitive to proteolytic cleavage. The cleaved toxin consists of two disulphide-linked fragments termed A (DT-A) and B (DT-B). DT-B binds to a cell-surface receptor which is the precursor of heparin-binding epidermal growth factor [2]. The toxin-receptor complex is then endocytosed and, under the acidic conditions in the endocytic compartment, the toxin undergoes conformational changes. As a consequence, part of the B-fragment is inserted into the membrane while the A-fragment is translocated to the cytosol.

Experimentally, DT-A can also be translocated from the cell surface. For this purpose, toxin is bound to cells under conditions where endocytosis is reduced and the cells are then exposed briefly to low pH at 37 °C to mimic the conditions in acidic endosomes [3,4]. Since toxin at the surface can be removed with Pronase, it is possible with this translocation system to distinguish between toxin remaining at the surface and toxin translocated into the cells.

Dihydrofolate reductase (DHFR) is a key enzyme in DNA synthesis. It catalyses the reduction of dihydrofolate to tetrahydrofolate and can be blocked by the cytostatic drug methotrexate (MTX) which binds with high affinity to, and inhibits unfolding of, the enzyme [5]. Fusion proteins of DHFR have been used to study membrane translocation in mitochondria [5], in the *Escherichia coli* inner membrane [6,7] and in dog pancreas microsomes [8]. At least partial unfolding of the protein appears to be a prerequisite for translocation in these systems, because when a folate analogue such as MTX was added, translocation of the DHFR fusion proteins was blocked.

Translocation of DHFR fusion proteins into chloroplasts

were, on the contrary, not prevented by the presence of MTX [9–11]. Nevertheless, unfolding is considered to also be a prerequisite for translocation across the double membrane chloroplast envelope because it was found that this membrane possessed a protein-unfolding activity strong enough to unfold DHFR even with MTX present [14]. Further translocation of DHFR fusion protein into thylakoids was blocked by MTX [14].

There is also evidence, for the translocation of DT-A across the endosomal membrane, that unfolding must occur for translocation to take place. A fusion protein of acidic fibroblast growth factor (aFGF) and DT-A, reconstituted with DT-B, was translocated into cells in the absence of heparin, but when heparin was added to stabilize the conformation of the aFGF moiety, translocation was blocked [12]. Falnes et al. [13] made several mutants where pairs of cysteine residues were introduced into DT-A to form internal disulphide bonds and thereby prevent unfolding. These mutants were not translocated.

We have tested the ability of constructs consisting of DT-A and a number of different proteins to be translocated to the cytosol. Despite specific receptor binding, most of these constructs could not be translocated (O. Klingenberg and S. Olsnes, unpublished work), possibly due to their inability to unfold under the conditions used. We demonstrate here that a fusion protein of DHFR and DT-A is translocated in the absence, but not in the presence, of MTX.

## EXPERIMENTAL

### Materials

*N*-Ethylmaleimide, PMSF, soybean trypsin inhibitor, NADPH, dihydrofolic acid, folic acid and MTX-agarose were obtained from Sigma, St. Louis, MO, U.S.A.; rabbit reticulocyte lysate and rRNasin from Promega, Madison, WI, U.S.A.; T3 RNA-polymerase from Gibco BRL, Gaithersburg, MD, U.S.A.; [<sup>35</sup>S]methionine from NEN Research Products, Wilmington, DE,

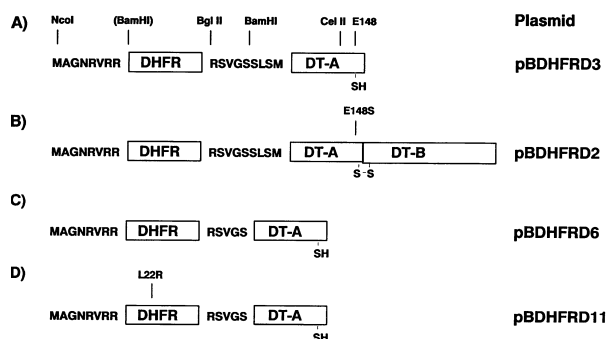

**Figure 1** Schematic presentation of the different fusion proteins used

The single-letter amino acid code is used. Important restriction sites are illustrated on (A), parentheses indicate a destroyed site. Amino acid 148 of DT-A is indicated. In the toxic (wild-type) variant of DT-A this is Glu (constructs A, C and D), whereas in construct B it is mutated to Ser, which strongly reduces the toxicity. Only the latter form is considered safe to be cloned together with DT-B. When the other fusion proteins are dialysed together with DT-B, the free SH-group indicated in A, C and D forms a disulphide bridge with an SH-group near the N-terminal end of DT-B.

U.S.A.; Protein A-Sepharose from Pharmacia, Uppsala, Sweden; and T4 DNA-polymerase and restriction endonucleases from New England Biolabs, Beverly, MA, U.S.A., except *CeIII* which was from Boehringer Mannheim, Germany.

### Cell culture

Vero cells (monkey kidney) and U2-OS cells (human osteosarcoma) were propagated in Dulbecco's modified essential medium (DMEM) with 7.5% (v/v) fetal-calf serum (FCS) in a 5% CO<sub>2</sub> atmosphere at 37 °C. Prior to the experiments (24 h) the cells were transferred to 12- or 24-well Costar or Falcon plates in the same medium.

### SDS/PAGE

SDS/PAGE was carried out with 10%, 12% or 15% (w/v) acrylamide gels as described by Laemmli [14]. The gels were fixed in 4% acetic acid/27% methanol for 30 min, and then treated with 1 M sodium salicylate, pH 5.8, in 2% (v/v) glycerol for 20 min. Dried gels were exposed to Kodak XAR-5 films at -80 °C to visualize proteins labelled with [<sup>35</sup>S]methionine.

### Plasmid construction

#### pBDHFRD2

Mouse DHFR coding sequence [15], modified to include a 5' *BamHI* site and a 3' *BglII* site (thereby removing the C-terminal Asp of the enzyme and adding Gly-Ser-Arg instead), was cleaved with *BamHI* and *BglII* and the fragment obtained was ligated into the *BglII* site of pBD-89 which is encoding the E148S mutant of DT with a 45 bp linker in front of the toxin (Figure 1B). This linker is derived from the trypsin-sensitive loop between DT-A and DT-B, here denoted as the loop linker. To form pBD-89, the plasmid pBD-30 [16] was cut with *NcoI* and a linker, 5'-CATGGCAGGAAATCGTGTGCGCAGATCTGTAGGATCCTCATTGAG-3', was ligated in to yield pBD-59. This was cut with *NcoI* and *CeIII* and the fragment obtained was cloned into pBD-1 ([17], there called pBND-2) cut with the same enzymes.

#### pBDHFRD3

The fragment from the *NcoI* site to the *CeIII* site of pBDHFRD2 was ligated into pBD-30 that had been cut with the same enzymes to yield the protein indicated in Figure 1(A). pBD-30 is coding for the wild-type DT-A fragment.

#### pBDHFRD6

By PCR-directed mutagenesis we made a cloning vector, denoted as 3N-vector, coding for the E148S mutant of DT where the initiation Met-codon was replaced by a polylinker region (5'-CCATGGCGGCCGCGGCGCC-3'), making it possible to add different coding sequences 5' to the toxin gene and at the same time avoid downstream translational initiation at the beginning of DT. This vector was cut with *NarI*, filled in with T4 DNA polymerase, cut with *NcoI* and ligated to a fragment obtained by cutting pBDHFRD2 with *BamHI*, filling in with T4 DNA polymerase and cutting with *NcoI*. This procedure yielded pBDHFRD5. The fragment from *NcoI* to *CeIII* of pBDHFRD5 was then ligated into pBD30 cut with the same enzymes, to obtain the construct in Figure 1(C).

#### pBDHFRD11

The DNA-sequence encoding the mutation L22R of DHFR [18] was introduced into pBDHFRD6 by PCR-directed mutagenesis, yielding pBDHFRD11 encoding the protein in Figure 1(D). The sequences of pBDHFRD6 and pBDHFRD11 made by PCR were confirmed by sequencing using the dideoxy-nucleotide-chain termination method.

### In vitro transcription and translation

The plasmids were linearized with *EcoRI* and transcribed *in vitro* with T3 RNA polymerase. Ethanol-precipitated transcripts were translated for 1 h 30 min at 30 °C in a nuclease-treated rabbit reticulocyte lysate system in the presence of unlabelled methionine, 1 μM [<sup>35</sup>S]methionine, or a combination of the two. After translation, when appropriate, lysates containing either DT-A or fusion protein lacking DT-B were mixed with an equal volume of lysate containing DT-B. The lysates were then dialysed against dialysis buffer (140 mM NaCl, 20 mM Hepes, 2 mM CaCl<sub>2</sub>), pH 7.0, to remove free [<sup>35</sup>S]methionine and reducing agent, allowing disulphide bridges to be formed [16].

### Affinity purification

MTX-agarose was pretreated according to the alternative method recommended by the manufacturer [19]. The column was then equilibrated with buffer A (100 mM KCl, 50 mM imidazole, 10% glycerol, 1 mM EDTA) [20], pH 6.5, and the dialysed translation mixture was diluted in the same buffer and applied to the column. After extensive washing with buffer A, pH 6.5, the fusion protein was eluted with 10 mM folic acid in buffer A, pH 8.0, and then dialysed extensively against dialysis buffer, pH 8.0.

### Cell binding and translocation

To measure binding, dialysed translation mixtures or affinity-purified fusion protein were added to Vero cells or U2-OS cells growing as monolayers in 12-well plates and kept at room temperature for 20 min in the presence of unlabelled methionine and 5 μM monensin. The cells were then washed five times with ice-cold Hepes medium and analysed by SDS/PAGE. To measure translocation, after binding the cells were exposed to pH 4.5 for

3 min, treated with Pronase and analysed by SDS/PAGE. To distinguish between material free in the cytosol and material associated with the membranes, after the Pronase treatment the cells were incubated with 50–200  $\mu\text{g}/\text{ml}$  saponin at 4 °C for 30 min, the soluble fraction was separated from the pellet fraction by centrifugation at 14000 rev./min in an Eppendorf centrifuge for 5 min at 4 °C and both fractions were analysed by SDS/PAGE [3].

### Trypsin sensitivity

An aliquot (1  $\mu\text{l}$ ) of dialysed translation mixture was incubated with different concentrations of tosylphenylalanyl-chloromethane-treated trypsin in Hepes medium (bicarbonate-free DMEM buffered with 20 mM Hepes), pH 7.5, for 1 h at 37 °C in the absence or presence of 55  $\mu\text{M}$  MTX, then 1 mM PMSF was added and the sample was analysed by SDS/PAGE under reducing conditions.

### Cytotoxicity

Dialysed unlabelled translation mixtures or affinity-purified fusion protein were added to U2-OS cells growing as monolayers in 24-well plates in DMEM supplemented with 7.5% (v/v) FCS, 0.1 mM PMSF, 50  $\mu\text{g}/\text{ml}$  leupeptin and 3  $\mu\text{g}/\text{ml}$  soybean trypsin inhibitor in the presence or absence of MTX. The cells were incubated overnight and protein synthesis was measured by incorporation of [ $^3\text{H}$ ]leucine into the trichloroacetic acid-precipitable material [12].

### DHFR enzyme activity

Because there is some DHFR activity in the reticulocyte lysate, and because the yield of protein made *in vitro* is rather low, we collected the fusion protein by immunoadsorption.

A volume of 200  $\mu\text{l}$  of Protein A–Sepharose was incubated with 15  $\mu\text{l}$  of rabbit anti-DT serum for 30 min at ambient temperature and then washed twice with PBS containing 1% Triton X-100. The Sepharose was then incubated for 2 h at 4 °C with 1 ml of dialysed translation mixture containing *in vitro*-synthesized DHFR–DT-A fusion protein as indicated in Figure 1(C), and centrifuged. The pellet was washed three times with PBS (140 mM NaCl, 10 mM  $\text{Na}_2\text{HPO}_4$ , pH 7.2) containing 1% Triton X-100 and twice with 50 mM Tris/HCl, pH 7.4. The DHFR enzyme activity of the DHFR–DT-A fusion protein bound to the Sepharose was then measured by a standard spectrophotometric method with incubation at 25 °C in 50 mM Tris/HCl, pH 7.4, containing 1 mM dithiothreitol, 50  $\mu\text{M}$  EDTA, 50  $\mu\text{M}$  NADPH and 100  $\mu\text{M}$  dihydrofolate [7,21]. Reactions were stopped at the different time points by centrifugal filtration in Costar Spin-X centrifuge filter units and the absorbance at 340 nm of the filtrate was measured. One unit of DHFR is the amount of enzyme which catalyses the reaction

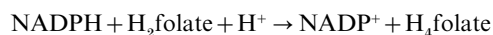

at a rate of 1  $\mu\text{mol}/\text{min}$  at pH 7.4 and 25 °C [7,22]. The molar absorption coefficient is 12000 litre  $\cdot$  mol $^{-1}$   $\cdot$  cm $^{-1}$  for this reaction. To estimate the amount of fusion protein translated *in vitro*, the lysate was analysed by SDS/PAGE and fluorography, and the radioactivity in the appropriate protein band was measured. The concentration was estimated assuming an endogenous concentration of 5  $\mu\text{M}$  methionine in the lysate (Promega's technical manual of the reticulocyte lysate system) in addition to exogenous 1  $\mu\text{M}$  [ $^3\text{S}$ ]methionine and 20  $\mu\text{M}$  unlabelled methionine [17].

## RESULTS

### Formation and purification of fusion proteins

DNA encoding DHFR and DNA encoding DT-A were connected by a linker ('loop linker') encoding an 8-amino-acid peptide derived from the trypsin-sensitive region between DT-A and DT-B. This resulted in a construct where the first amino acid in DT is methionine (Figure 1A). Upon *in vitro* translation of this construct initiation occurred both at the initiator methionine of DHFR and at that of DT-A. For some purposes such downstream initiation is very disadvantageous (see below). Therefore, we also made a construct where the methionine at the beginning of DT-A and the three last amino acids of the loop linker were deleted (Figure 1C). We also cloned the DHFR–DT-A construct in Figure 1(A) in the context of full-length DT. Because it is considered hazardous to clone full-length wild-type DT in bacteria, we used the E148S mutant of DT for this purpose (Figure 1B). This mutation in the active site of DT-A strongly reduces the toxicity of DT [23]. The mutation L22R of DHFR [18] has a 270 times lower affinity for MTX than does wild-type DHFR [24]. We introduced this mutation into the fusion protein to obtain the construct in Figure 1(D).

The different constructs were transcribed *in vitro* and translated in a nuclease-treated rabbit reticulocyte lysate. In the cases of Figures 1(A), 1(C) and 1(D), when appropriate, the translation mixture was subsequently mixed with DT-B translated *in vitro*. In all cases the lysates were subsequently dialysed to remove free [ $^3\text{S}$ ]methionine as well as reducing agents allowing disulphide-bridge formation. In some cases, after dialysis, the fusion protein was affinity-purified on a MTX–agarose column.

### Trypsin sensitivity and enzymic activity of DHFR in fusion proteins

To test if the DHFR moiety of the fusion protein was correctly folded and thereby capable of binding MTX, we took advantage of the observation that MTX imposes tight folding on the enzyme which thereby becomes highly resistant to trypsin [25]. Trypsin-sensitivity experiments were carried out in the absence and presence of 55  $\mu\text{M}$  MTX as demonstrated in Figure 2 for the construct in Figure 1(B). At low trypsin concentrations the fusion protein was cleaved into fragments with migration rates in

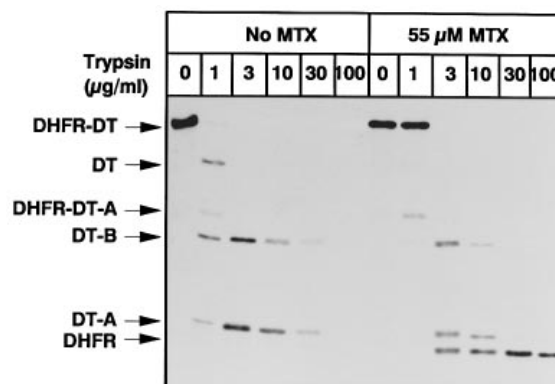

**Figure 2** Trypsin sensitivity of the fusion protein in the absence and presence of 55  $\mu\text{M}$  MTX

The construct with full-length DT (Figure 1B) was used. One  $\mu\text{l}$  of dialysed translation mixture was incubated for 1 h at 37 °C with different concentrations of trypsin and analysed by SDS/PAGE under reducing conditions.

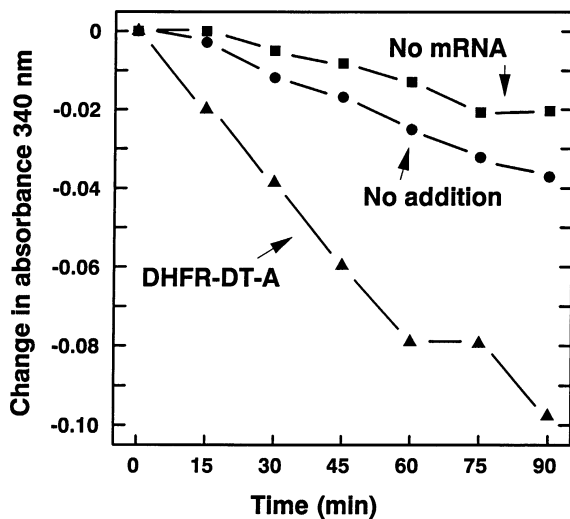

**Figure 3** Enzyme activity of immunoadsorbed fusion protein

Protein A–Sepharose with bound rabbit antiserum to DT was used to adsorb the fusion protein shown in Figure 1(C) from 1 ml of dialysed translation mixture. Aliquots of the immunoadsorbed material were assayed for DHFR enzyme activity as described in the Experimental section. Reactions were stopped at different time points by centrifugal filtration and the absorbance at 340 nm was measured (DHFR–DT-A). As a control, immunoadsorption of 400  $\mu$ l of a dialysed lysate with no added mRNA was used (no mRNA). A parallel experiment with no addition to the reaction mixture is also included (no addition).

SDS/PAGE corresponding to those of DT, DHFR–DT-A, DT-B, DT-A and DHFR. We interpret this as cleavage in the highly trypsin-sensitive loop between DT-A and DT-B and in the linker between DHFR and DT-A which is derived from the same loop. In the absence of MTX most of the DHFR moiety was rather sensitive to trypsin degradation, while the DT-A and DT-B moieties exhibited considerable trypsin resistance typical for these polypeptides.

In the presence of 55  $\mu$ M MTX the trypsin sensitivity of DT-A and DT-B was not affected, while the DHFR moiety now became very resistant to trypsin. In other experiments, where we used even higher concentrations of trypsin, we could see a band corresponding to DHFR after treatment with as much as 1 mg/ml trypsin in the presence of MTX. Also, when the treatment was carried out at pH 4.5 a band corresponding to DHFR was highly resistant to trypsin in the presence, but not in the absence, of MTX (results not shown). Clearly the data indicate that the DHFR moiety bound MTX strongly, and that this also was the case at the pH used for translocation (see below).

To test further whether the DHFR moiety was correctly folded, we tested whether DHFR of the fusion protein exhibited enzymic activity. Because there is some DHFR activity in the reticulocyte lysate that masked the activity of the *in vitro*-translated fusion protein (results not shown), and because the yield of protein made *in vitro* is rather low, we decided to collect the fusion protein by immunoadsorption on to Protein A–Sepharose beads with immobilized antibodies against the DT-A part of the fusion protein. As a control we used Protein A–Sepharose treated identically and exposed to dialysed translation mixture with no added mRNA. After washing the beads, we incubated aliquots under standard conditions to measure DHFR activity, stopped the reaction at different time points by centrifugal filtration and measured the absorbance at 340 nm immediately (Figure 3). A parallel with no Protein A–Sepharose added was also included to correct for the non-catalysed reaction.

The slope of the curve for the control reaction (no mRNA) was almost equal to that where no Protein A–Sepharose was added, but the absolute absorbance was somewhat lower, mainly due to dilution of the sample by the volume needed to disperse the Sepharose beads into aliquots.

The immunoadsorbed fusion protein showed a low, but measurable enzymic activity (Figure 3). Based on the molar absorbance coefficient for the DHFR reaction we calculate that we had immunoadsorbed a DHFR activity of about  $5 \times 10^{-4}$  units from 1 ml of reticulocyte lysate. Commercially available bovine DHFR (Sigma, D6385) has a specific activity of about 8 units/mg of protein. If we consider this as the activity of the pure protein, we calculate that we have obtained an activity corresponding to about 63 ng of DHFR/ml of reticulocyte lysate, or about 125 ng of fusion protein/ml of reticulocyte lysate. Based on radioactivity measurements of [ $^{35}$ S]methionine incorporated into the fusion protein [17], we estimated a yield of about 150 ng of fusion protein/ml of reticulocyte lysate. Clearly therefore, the DHFR of the fusion protein possessed nearly full enzyme activity.

Altogether, the data indicate that the DHFR moiety was correctly folded, as it was enzymically active and bound MTX. Also the DT part of the fusion protein appears to fold correctly as it showed normal trypsin sensitivity, and as the fusion protein was bound to the DT-receptor in a specific manner (see below).

#### Binding and translocation of reconstituted DHFR–DT-A + DT-B

The binding properties of the fusion protein reconstituted with DT-B were measured on Vero cells and U2-OS cells, which are both rich in DT receptors [26,27]. In Figure 4(A) this is shown for the construct in Figure 1(A) with Vero cells. The reconstituted fusion protein was bound specifically to the DT receptor as demonstrated by the ability of excess unlabelled DT to reduce the binding (Figure 4A, compare lanes 1 and 2). The binding was largely unaffected by the presence of MTX (Figure 4A, lane 3).

To study the translocation competence of the construct, we bound the reconstituted fusion protein to cells, exposed the cells briefly to acidic medium (pH 4.5) and then treated with Pronase to remove non-translocated material. Finally the cells were dissolved and analysed by SDS/PAGE to identify protected radiolabelled material [3,28]. As shown in Figure 4(B) (lane 1) a protein band with a molecular mass of 41 kDa, corresponding to the DHFR–DT-A fusion protein, was protected. On the other hand, when 55  $\mu$ M MTX was present in the translocation experiment, no band corresponding to the fusion protein was seen (Figure 4B, lane 3). When exposure to acidic medium was omitted, no protein band was protected (Figure 4B, lane 2). Translocation of DT-A was not inhibited by MTX when reconstituted DT was used (Figure 4C, compare lanes 1 and 2), showing that MTX does not inhibit DT translocation as such.

The DHFR L22R mutation reduces by 270-fold the affinity for MTX [18,24]. With the construct where we had introduced this mutation (Figure 1D), the fusion protein was translocated both in the absence and presence of 55  $\mu$ M MTX (Figure 4D, compare lanes 3 and 4 with lanes 1 and 2).

The possibility existed that the fusion protein was stuck in the membrane rather than free in the cytosol. To study this we treated the cells with low concentrations of saponin to allow cytoplasmic proteins to diffuse out of the cells. After centrifugation the released proteins are present in the supernatant, whereas membrane-associated proteins are obtained in the pellet [3]. With saponin concentrations in the range 50–200  $\mu$ g/ml the fusion protein was found in the supernatant (Figure 5), indicating

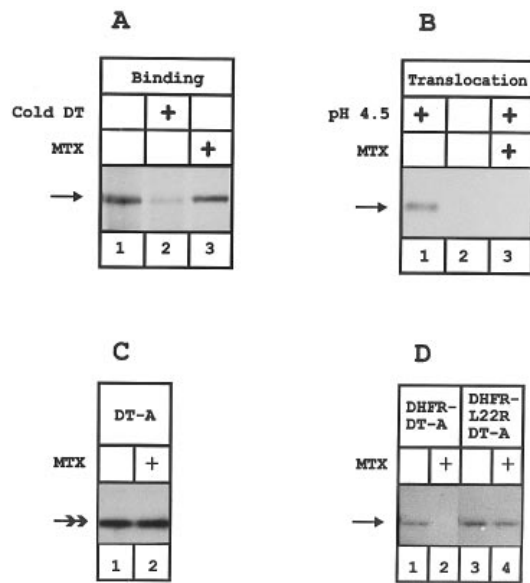

**Figure 4** Cell binding and translocation of fusion protein reconstituted with DT-B fragment

(A) The construct in Figure 1(A) reconstituted with DT-B was used. Vero cells were incubated for 20 min at room temperature with dialysed translation mixtures of the fusion protein alone (lane 1) or in the presence of excess unlabelled DT (lane 2) or 55  $\mu$ M MTX (lane 3). The cells were then washed five times and analysed by SDS/PAGE. (B) Vero cells were incubated with translation mixture as in (A). After washing, the cells were exposed for 3 min to pH 4.5 at 37  $^{\circ}$ C (lanes 1 and 3) or kept at pH 7.4 (lane 2). In lane 3, 55  $\mu$ M MTX was present during binding and treatment with pH 4.5. The cells were then treated with Pronase and analysed by SDS/PAGE. (C) and (D) DT-A (C), fusion protein with wild-type DHFR (Figure 1C) (D, lanes 1 and 2) and fusion protein with the DHFR L22R mutation (Figure 1D) (D, lanes 3 and 4) was reconstituted with DT-B and bound to U2-OS cells. The cells were washed, exposed to pH 4.5 and Pronase-treated as in (B). In (C) (lane 2) and (D) (lanes 2 and 4), 55  $\mu$ M MTX was present. Arrows indicate the level of the fusion proteins, double arrowhead indicates the level of DT-A.

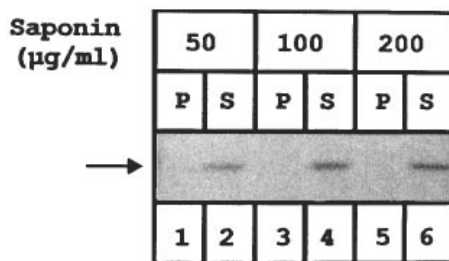

**Figure 5** Saponin fractionation of cells after fusion protein translocation

U2-OS cells were treated as described in Figure 4(D), lane 1. After the Pronase treatment, the cells were washed in cold Hepes medium containing 1 mM PMSF and 1 mM *N*-ethylmaleimide, treated with PBS with different concentrations of saponin for 30 min at 4  $^{\circ}$ C, and the membrane fraction (P) was separated from the cytosol fraction (S) by centrifugation in an Eppendorf centrifuge. The fractions were then analysed by SDS/PAGE. The arrow indicates the level of the fusion protein.

that in the absence of MTX the DHFR-DT-A fusion protein is translocated to the cytosol.

#### Ability of MTX to protect cells against intoxication by the fusion protein

To study toxicity of DHFR-DT-A, we added to cells increasing amounts of fusion protein (Figure 1C) that had been reconstituted

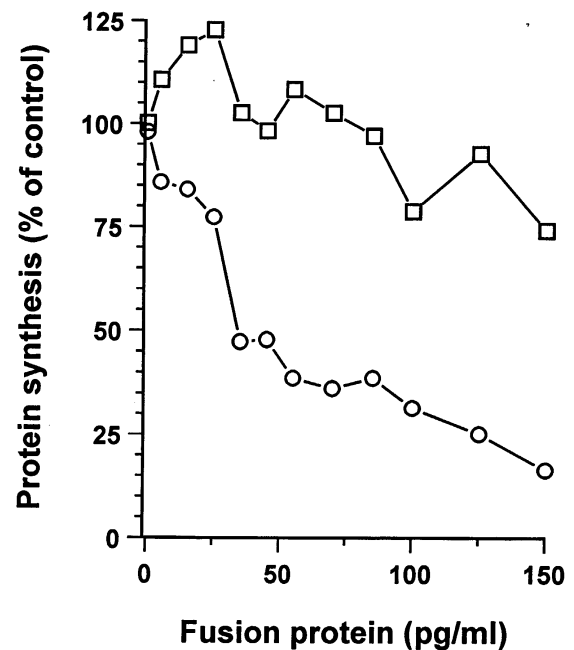

**Figure 6** Ability of MTX to inhibit the cytotoxicity of the reconstituted fusion protein

U2-OS cells were incubated overnight with different amounts of affinity-purified fusion protein as illustrated in Figure 1(C) reconstituted with DT-B in the absence of (circles) or presence of (squares) 55  $\mu$ M MTX. Protein synthesis was then measured as the ability of the cells to incorporate [ $^3$ H]leucine over 30 min. To the control samples were added the same volumes of dialysed affinity column elution buffer.

with DT-B and purified on a MTX-agarose affinity column, incubated the cells overnight and measured protein synthesis by [ $^3$ H]leucine incorporation. To minimize proteolytic cleavage in the loop linker between DHFR and DT-A, we added PMSF, leupeptin and soybean trypsin inhibitor during the incubations, and we used U2-OS cells which possess relatively low surface protease activity. As a control we used dialysed elution buffer that had not passed through the MTX-agarose column. This buffer alone did not inhibit protein synthesis at the concentrations used. A weak reduction of protein synthesis was, on the other hand, observed with MTX alone in these overnight experiments. The data in Figure 6 have been corrected for this. The toxicity of wild-type DT was unaffected by the presence of 55  $\mu$ M MTX (results not shown).

As shown in Figure 6, the fusion protein was clearly toxic to cells. When 55  $\mu$ M MTX was added to the incubations, the toxicity of the fusion protein was clearly diminished although MTX did not protect the cells fully against the fusion protein, probably because we were unable to completely prevent cleavage in the loop linker between DHFR and DT-A. It was evident that cleavage here represented a problem in the toxicity experiments. Thus, when we used Vero cells, which have high surface protease activity, rather than U2-OS cells, and did not add protease inhibitors, we did not observe any protective effect of MTX (results not shown).

MTX protected the U2-OS cells from the fusion protein toxicity in a dose-dependent manner. There was no appreciable protective effect of 5.5 nM MTX (results not shown), whereas from 55 nM up to 550  $\mu$ M MTX the protection increased gradually (Figure 7).

Altogether, the data indicate that the fusion protein can enter

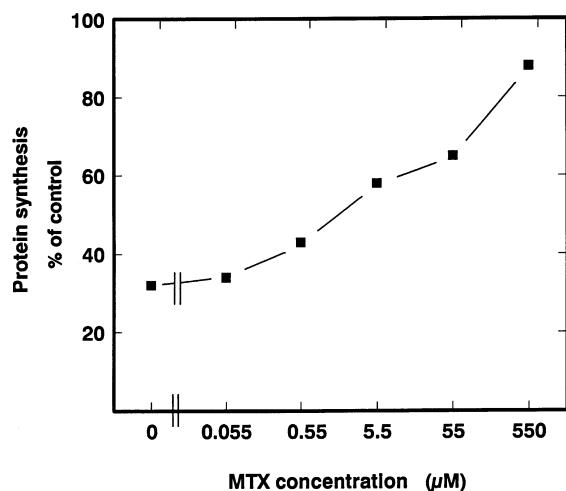

**Figure 7** Ability of increasing amounts of MTX to inhibit the cytotoxic effect of the fusion protein

U2-OS cells were incubated overnight with 3  $\mu$ l/ml dialysed translation mixture containing the fusion protein in Figure 1(C) reconstituted with DT-B in the presence of different concentrations of MTX. Protein synthesis was then measured as [ $^3$ H]leucine incorporation. Cells in the control wells were incubated with the same amounts of dialysed translation mixture with no added mRNA.

the cytosol by the DT pathway and that MTX inhibits the translocation, presumably due to its ability to inhibit unfolding on the DHFR part of the fusion protein.

## DISCUSSION

The main finding presented here is that DHFR fused to DT could be translocated to the cytosol along with DT-A, and that the presence of 55  $\mu$ M MTX inhibited this translocation. MTX imposes tight folding on DHFR, and judged from the trypsin-sensitivity experiments, this appears to be the case also for the DHFR moiety of the DHFR-DT fusion protein. MTX had no appreciable effect on the translocation of DT-A as such. The observation that the fusion protein containing the DHFR L22R mutation with low MTX affinity could be translocated even in the presence of MTX indicates that it is the interaction between MTX and DHFR and presumably the resulting tightly folded conformation of DHFR that prevents the translocation of the fusion protein with wild-type DHFR.

It has been shown previously that DT-A can carry passenger proteins into the cytosol, such as aFGF [12] and an extra DT-A chain [29]. The present paper is the first demonstration that a resident cytosolic enzyme can be translocated along with DT-A across the cell membrane. We believe that the DHFR moiety of the fusion protein was folded in the right conformation as it exhibited enzymic activity. Więdołcha et al. [12] showed that the translocation of the fusion protein of aFGF and DT-A was blocked by the addition of heparin, which imposes tight folding on aFGF. Our findings are in good accordance with this, as MTX inhibited the translocation of the DHFR-DT-A fusion protein. Falnes et al. [13] showed that genetically engineered internal disulphide bonds in DT-A inhibited its translocation. Taken together, these data indicate that both the A-fragment of DT and any passenger protein must be able to unfold at least partially under the acidic conditions of the endosome in order to be translocated to the cytosol.

The possibility of using protein toxins with intracellular sites

of action to carry passenger proteins into cells opens a number of interesting possibilities. We have previously discussed translocation of peptides that can later be picked up by nascent major histocompatibility class I molecules and be presented at the cell surface to activate CD8<sup>+</sup> T-lymphocytes for vaccine purposes [30]. Więdołcha et al. [27] fused aFGF to DT and showed that after entering the cytosol the fusion protein was transported to the nucleus, apparently due to a nuclear localization sequence in the growth factor. As a result, it induced DNA synthesis in the cells. Possibly, a number of regulatory proteins could be brought into cells in this way.

There are, however, a number of obstacles to this method. In the first place the fusion of peptides, and particularly of whole proteins to the N-terminal end of DT-A, often has the consequence that the fusion protein does not reconstitute with DT-B, indicating that it does not fold correctly. But even in cases where it does reconstitute, the specific binding to DT receptors, which is a prerequisite for translocation, may not occur. Finally, even constructs that do bind correctly do not always translocate. Thus, we have made several constructs where we have fused DT-A to interleukin 1 $\alpha$  and to interleukin 2. These fusion proteins did reconstitute with DT-B and exhibited specific binding to the DT receptor. In spite of this we have not been able to detect any Pronase-protected material in translocation experiments (O. Klingenberg and S. Olsnes, unpublished work). From the present and previous papers [12,13] a likely explanation is that these proteins do not unfold sufficiently at low pH to allow translocation to take place.

Several proteins can be translocated from the exterior to the cytosol. The best-established examples are a number of protein toxins such as DT, ricin, Pseudomonas toxin and others [31]. Indeed, conjugates of antibodies and the enzymically active moiety of protein toxins can also translocate the active part into the cytosol and inhibit protein synthesis [32]. It should be noted, however, that the use of protein synthesis inhibition as a measure of translocation does not give a quantitative estimate of the amount of translocated protein, which may be very small but still detectable due to the very high activity of the molecules. Furthermore, that approach cannot be used to monitor translocation of fusion proteins, as the toxic effect does not depend on the intactness of the fusion protein. The advantage of the system we have used is that it is possible to monitor directly translocation of radioactively labelled fusion protein.

We are grateful to Jorunn Jacobsen and to Marianne Andreassen for their help with the cell cultures and to Pål Falnes and Antoni Więdołcha for carefully reading the manuscript. This work was supported by The Norwegian Research Council, The Jahre Foundation, Rachel and Otto Kr. Bruuns Legat, Blix Legat and Astri and Birger Torsteds Legat. O.K. is a fellow of The Norwegian Cancer Society.

## REFERENCES

- Pappenheimer, A. M., Jr. (1977) *Annu. Rev. Biochem.* **46**, 69–94
- Naglich, J. G., Metherall, J. E., David, W. R. and Eidels, L. (1992) *Cell* **89**, 1051–1061
- Moskaug, J. Ø., Sandvig, K. and Olsnes, S. (1988) *J. Biol. Chem.* **263**, 2518–2525
- Sandvig, K. and Olsnes, S. (1980) *J. Cell Biol.* **87**, 828–832
- Eilers, M. and Schatz, G. (1986) *Nature (London)* **322**, 228–232
- Freudl, R., Schwartz, H., Kramps, S., Hindennach, I. and Henning, U. (1988) *J. Biol. Chem.* **263**, 17084–17091
- Arkowitz, R. A., Joly, J. C. and Wickner, W. (1993) *EMBO J.* **12**, 243–253
- Schlenstedt, G., Gudmundson, G. H., Boman, H. G. and Zimmermann, R. (1990) *J. Biol. Chem.* **265**, 13960–13968
- Guéra, A., America, T., van Waas, M and Weisbeek, P. (1993) *Plant Mol. Biol.* **23**, 309–324
- America, T., Hageman, J., Guéra, A., Rook, F., Archer, K., Keegstra, K. and Weisbeek, P. (1994) *Plant Mol. Biol.* **24**, 283–294

- 11 Endo, T., Kawakami, M., Goto, A., America, T., Weisbeek, P. and Nakai, M. (1994) *Eur. J. Biochem.* **225**, 403–409
- 12 Więdłocha, A., Madshus, I. H., Mach, H., Middaugh, C. R. and Olsnes, S. (1992) *EMBO J.* **11**, 4835–4842
- 13 Falnes, P. Ø., Choe, S., Madshus, I. H., Sandvig, K., Wilson, B. A. and Olsnes, S. (1994) *J. Biol. Chem.* **269**, 8402–8407
- 14 Laemmli, U. K. (1970) *Nature (London)* **227**, 680–685
- 15 Nunberg, J. H., Kaufman, R. J., Chang, A. C. Y., Cohen, S. N. and Schimke, R. T. (1980) *Cell* **19**, 355–364
- 16 Stenmark, H., Afanasiev, B. N., Ariansen, S. A. and Olsnes, S. (1992) *Biochem. J.* **281**, 619–625
- 17 McGill, S., Stenmark, H., Sandvig, K. and Olsnes, S. (1989) *EMBO J.* **8**, 2843–2848
- 18 Simonsen, C. C. and Levinson, A. D. (1983) *Proc. Natl. Acad. Sci. U.S.A.* **80**, 2495–2499
- 19 Kaufman, B. T. (1974) *Methods Enzymol.* **34B**, 272–281
- 20 Prendergast, N. J., Delcamp, T. J., Smith, P. L. and Freisheim, J. H. (1988) *Biochemistry* **27**, 3664–3671
- 21 Pastore, E. J., Plante, L. T. and Kisliuk, R. L. (1974) *Methods Enzymol.* **34B**, 281–288
- 22 Blakley, R. L. (1969) *The Biochemistry of Folic Acid and Related Pteridines*, Elsevier, New York
- 23 Barbieri, J. T. and Collier, R. J. (1987) *Infect. Immun.* **55**, 1647–1651
- 24 Haber, D. A., Beverley, S. M., Kiely, M. L. and Schimke, R. T. (1981) *J. Biol. Chem.* **256**, 9501–9510
- 25 Hakala, M. T. and Suolinna, E.-M. (1966) *Mol. Pharmacol.* **2**, 465–480
- 26 Middlebrook, J. L., Dorland, R. B. and Leppla, S. H. (1978) *J. Biol. Chem.* **253**, 7325–7330
- 27 Więdłocha, A., Falnes, P. Ø., Madshus, I. H., Sandvig, K. and Olsnes, S. (1994) *Cell* **76**, 1039–1051
- 28 Moskaug, J. Ø., Stenmark, H. and Olsnes, S. (1991) *J. Biol. Chem.* **266**, 2652–2659
- 29 Madshus, I. H., Olsnes, S. and Stenmark, H. (1992) *Infect. Immun.* **60**, 3296–3302
- 30 Stenmark, H., Moskaug, J. Ø., Madshus, I. H., Sandvig, K. and Olsnes, S. (1991) *J. Cell Biol.* **113**, 1025–1032
- 31 Olsnes, S. and Sandvig, K. (1988) in *Immunotoxins* (Frankel, A. E., ed.), pp. 39–73, Martinus Nijhoff Publishing, Boston
- 32 Olsnes, S., Sandvig, K., Petersen, O. W. and van Deurs, B. (1989) *Immunol. Today* **10**, 291–295

---

Received 20 June 1995/31 August 1995; accepted 8 September 1995