

# The protein kinase A catalytic subunit $C\beta 2$ : molecular characterization and distribution of the splice variant

Sandra THULLNER<sup>\*1</sup>, Frank GESELLCHEN<sup>\*</sup>, Stefan WIEMANN<sup>†</sup>, Walter PYERIN<sup>‡</sup>, Volker KINZEL<sup>\*</sup> and Dirk BOSSEMEYER<sup>\*2</sup>

<sup>\*</sup>Department of Pathochemistry, German Cancer Research Center, DKFZ, INF 280, D-69120 Heidelberg, Germany, <sup>†</sup>Department of Molecular Genome Analysis, German Cancer Research Center, DKFZ, INF 280, D-69120 Heidelberg, Germany, and <sup>‡</sup>Department of Biochemical Cell Physiology, German Cancer Research Center, DKFZ, INF 280, D-69120 Heidelberg, Germany

$C\beta 2$ , a 46 kDa splice variant of the  $C\beta$  isoform, is the largest isoform so far described for catalytic subunits from cAMP-dependent protein kinase in mammals. It differs from  $C\beta$  in the first 15 N-terminal residues which are replaced with a 62-residue domain with no similarity to other known proteins. The  $C\beta 2$  protein was identified in cardiac tissue by MS, microsequencing and C-subunit-isoform-selective antibodies. The  $C\beta 2$  protein has a very low abundance of about 2% of total affinity-purified C subunits from bovine cardiac tissue. This, and the similarity of its biochemical properties to  $C\alpha$  and  $C\beta$ , are probably some of the reasons why the  $C\beta 2$  protein has escaped detection so far. The abundance of the  $C\beta 2$  protein differs dramatically between tissues, with most protein detected in heart, liver and spleen, and the lowest level in testis.  $C\beta 2$  protein shows kinase activity against synthetic substrates, and is inhibited by the protein kinase inhibitor peptide PKI(5-24). The degree of  $C\beta 2$  removal

from tissue extracts by binding to PKI(5-24) depends on the cAMP level, i.e. on the dissociation state of the holoenzyme. Two sites in the protein are phosphorylated: Thr-244 in the activation segment and Ser-385 close to the C-terminus. By affinity purification and immunodetection  $C\beta 2$  was found in cattle, pig, rat, mouse and turkey tissue and in HeLa cells. In the cAMP-insensitive CHO 10260 cell line, which has normal  $C\beta$  but is depleted of  $C\alpha$ , stable transfection with  $C\beta 2$  restored most of the cAMP-induced morphological changes.  $C\beta 2$  is a ubiquitously expressed protein with characteristic properties of a cAMP-dependent protein kinase catalytic subunit.

**Key words:** alternative splicing, cAMP-dependent protein kinase, isoform-selective antibody, morphological change, tissue distribution.

## INTRODUCTION

The cAMP-dependent protein kinase (PKA) is a key enzyme in cellular signalling pathways. The holoenzyme of PKA is an inactive tetramer composed of a regulatory subunit dimer and two catalytic subunits. Increases in the level of cAMP dissociate active C subunits, leading to the phosphorylation of substrate proteins. A great variety of different stimulatory agents cause a corresponding number of cellular responses [1]. Some of the diverse actions of cAMP are likely to be regulated by differences in the biochemical properties of the PKA subunit isoforms. In mammalia, in addition to two RI ( $RI\alpha$  and  $RI\beta$ ) and two RII ( $RII\alpha$  and  $RII\beta$ ) regulatory subunits, two closely related isoforms of the catalytic subunit,  $C\alpha$  and  $C\beta$ , are found; a  $C\gamma$  isoform has been described in testis from primates [2–6].

The predominant isoform of the PKA C subunit is  $C\alpha$ . This protein is expressed relatively evenly in all tissues examined [2,7–9]. The  $C\beta 1$  subunit mRNA is transcribed in a slightly more tissue-dependent manner, and seems to be most abundant in brain, heart and spleen [4,5,7,9,10]. Although purification protocols have long existed for PKA C subunits, specific isolation procedures for either  $C\alpha$  or  $C\beta 1$  have not been developed so far, because of the highly similar physicochemical properties of both isoforms [11], unless they are recombinantly expressed [12–14]. Whereas specific functions of the variants of the regulatory subunits have been described, little is known about the individual roles of the catalytic-subunit isoforms *in vivo*. Evidence that  $C\beta 1$

serves an *in vivo* function distinct from  $C\alpha$  comes from transgenic mice. Mice with a targeted disruption in the first exon of the gene coding for  $C\beta 1$  lacked both long-term depression and depotentiation at the hippocampal Schaffer collateral-CA1 pathway. The late phase of long-term potentiation, which is transcription-dependent, is significantly decreased. Also, the mossy fibre long-term potentiation was abolished [15,16]. Biochemical evidence indicates differences in the kinetics of substrate phosphorylation by  $C\beta 1$  compared with  $C\alpha$ , and a several-fold-lower  $K_m$  value for cAMP of a type-II  $C\beta 1$  holoenzyme, verified in COS-1 cells [14].

Alternative splicing of the first exon of  $C\beta$  results in the mRNA for  $C\beta 2$  [7,17]. Fifteen  $C\beta 1$  N-terminal amino acid residues are replaced by 62 residues with no similarity to known proteins.  $C\beta 2$ , with a calculated molecular mass of 46268 Da, is the largest C-subunit isoform so far known from mammals.  $C\beta 2$  has been cloned from bovine tissue, the mRNA has been detected in human cell lines and also in Chinese hamster ovary (CHO) cells, and the promoter of the  $C\beta 2$  gene has been characterized [17]. For the murine  $C\beta$  gene two further splice variants of the first exon have been identified that are brain-specific and contain a short exon (exon 1) coding for three and four amino acids respectively [10,16]. A splice variant of  $C\alpha$ , in contrast, codes for 224 amino acids and lacks the C-terminus, including subdomains IX–XI [18]. Alternatively spliced products of PKA C subunits are also known from non-mammalian species.

Abbreviations used: PKI, protein kinase inhibitor; PKI(5-24), PKI fragment 5-24; PKA, cAMP-dependent protein kinase; CHO, Chinese hamster ovary; MALDI MS, matrix-assisted laser-desorption ionization MS;  $\mu$ LC-ESI-MS, micro-liquid-chromatography electrospray ionization MS; 8-Br-cAMP, 8-bromo-adenosine 3',5'-cyclic monophosphate.

<sup>1</sup> Present address: Aventis, Nattermannallee 1, D-50829 Köln, Germany.

<sup>2</sup> To whom correspondence should be addressed (e-mail d.bossemeier@dkfz-heidelberg.de).

The N-termini of  $C\alpha$  and  $C\beta 1$  are myristoyl-acylated at the N-terminal glycine residue [11,19], the function of which is unclear [20]. The 14 N-terminal residues, representative of  $C\alpha$  exon 1, direct a pp60<sup>v-Src</sup> chimaera to the plasma membrane [21]. Membrane association of  $C\alpha$  or  $C\beta 1$  has not yet been described, but myristoylation enhances liposome binding the C subunit in the presence of the RII subunit [22]. The  $C\beta 2$  N-terminus lacks a myristoylation signal. According to secondary-structure predictions it has a high helix content of 50% and may contain an amphipathic helix, a potential site for molecular interactions [7].

In this report we demonstrate that the  $C\beta 2$  mRNA is translated into protein in several bovine tissues, verified by highly selective anti- $C\alpha$ , anti- $C\beta$  and anti- $C\beta 2$  antibodies, Edman sequencing and MS. Its extremely low protein-expression level amounts to a few percent of total C subunit in the tissue. Recombinant  $C\beta 2$  was highly susceptible to proteolysis, therefore the protein was enriched from native sources and characterized as cAMP-regulated, kinase-active, protein kinase inhibitor (PKI)-sensitive and 2-fold phosphorylated. Furthermore, it was shown that  $C\beta 2$  is dispersed in the cytoplasm and in the nucleus and restores certain defects of a  $C\alpha$ -deficient CHO cell line.

## MATERIALS AND METHODS

### Materials

Chemicals were from Sigma, unless otherwise stated, and radiochemicals were from Amersham. Synthetic peptides were as follows: PKI fragment 5-24 [PKI(5-24)], TTYADFIASGRTGR-RNAIHD; SP20, TTYADFIASGRTGRRASIHD; Kemptide, LRRASLG.

### Antibodies

A  $C\beta 2$ -specific antibody was raised against the sequence ( $A_3$ YR-EVPSNQYTG<sub>14</sub>C) of the  $C\beta 2$  N-terminus and was designated anti- $C\beta 2$ (3-14). A  $C\alpha$ -specific polyclonal rabbit antibody was raised against the C-subunit fraction from bovine heart, which contains a mixture of  $C\alpha$  and  $C\beta 1$  protein [11]. The antibody did not recognize  $C\beta$  and is therefore designated anti- $C\alpha$ . The immunoglobulin fraction was enriched on a Protein A column. Antibody anti-PKA <sub>$\beta$ cat</sub> is a commercial antibody from Santa Cruz Biotechnology, raised against a C-terminal peptide sequence of  $C\beta$ , but which recognizes  $C\alpha$  and  $C\beta$  equally well.

For  $C\alpha$ -selective antibodies the peptide sequence 35–46 of bovine  $C\alpha$  was used for immunization, resulting in antibody anti- $C\alpha$ (35-46). Correspondingly, a  $C\beta$ -selective antibody was made against peptide sequence 35–46 of bovine  $C\beta$ , designated anti- $C\beta$ (35-46). All peptides used for antibody generation contained an additional Cys residue at the C-terminus for thiol-coupling to keyhole limpet haemocyanin before immunization of the rabbits. All peptide antibodies were purified on an affinity column (Affi-Gel 10, Bio-Rad) with their corresponding peptides immobilized. For comparative quantifications of ECL\* (Amersham)-labelled Western blots, digitized scans were analysed with the software program TINA (raytest).

### $C\beta 2$ protein purification (partial)

The catalytic subunits from bovine heart (2 kg) were isolated by a combination of methods described elsewhere [13,23,24]. All steps were performed at 4 °C and the potassium phosphate buffers all contained 2 mM dithiothreitol and 1 mM EDTA. In brief, 3 litres of 50 mM potassium phosphate, pH 6.5, were used for homogenization of 2 kg of tissue in a commercial Waring blender. The homogenate was centrifuged at 10000 *g* for 20 min and the supernatant poured over cheese cloths and glass wool. In

batches, soluble proteins were bound to 1 litre of DEAE cellulose (Whatman). After washing with 80 mM potassium phosphate, pH 6.5, protein was eluted with 300 mM potassium phosphate, pH 6.5, the eluate diluted with water to 50 mM potassium phosphate, and the protein was bound to 0.7 litres of DEAE cellulose. The cellulose was washed with 15 litres of 50 mM potassium phosphate, pH 6.5, collected in a column and washed with 10 litres of 15 mM potassium phosphate, pH 6.1.

Elution of the catalytic  $C\alpha/C\beta 1$  subunits started with 0.6 litre of 50 mM potassium phosphate, pH 6.5, with 200  $\mu$ M cAMP. The elution was continued with a 2-litre gradient of 15–400 mM potassium phosphate, pH 6.5, containing 200  $\mu$ M cAMP. Fractions with a conductivity corresponding to 80–300 mM potassium phosphate were pooled, and the conductivity was lowered with water to a value corresponding to 50 mM potassium phosphate. The pH was adjusted to 7, and ATP, cAMP and MgCl<sub>2</sub> were added to 1 mM, 20  $\mu$ M and 2 mM, respectively. PKI(5-24) (18 mg) was coupled to 20 ml of Affi-Gel 10 [13]. PKI(5-24) affinity-gel matrix (3.5 ml) was added and incubated with slight stirring for at least 1 h. The affinity material was collected in a column, washed with 2 mM MgCl<sub>2</sub>, 50 mM NaCl, 250  $\mu$ M ATP, protease-inhibitor cocktail (Boehringer Mannheim) and 50 mM Tris/HCl, pH 7.4, and subsequently with the same buffer plus 200 mM NaCl. Elution was carried out with 50 ml of 200 mM arginine, 50 mM NaCl, 1 mM EDTA, protease-inhibitor cocktail and 50 mM Tris/HCl, pH 7.4. Eluted proteins were concentrated on Centriprep 30 (Amicon).

### Small-scale PKI(5-24) affinity purification

This method used two modifications of Olsen and Uhler's method [13]. Soluble protein (20 mg) with ATP and MgCl<sub>2</sub> were added to 100  $\mu$ l of PKI(5-24) affinity-gel matrix in a 1.5 ml test tube. cAMP at 20  $\mu$ M or various concentrations was added and incubated for 2 h. The PKI(5-24) affinity-gel matrix was sedimented and the supernatant was discarded or transferred to another 100  $\mu$ l of PKI(5-24) affinity-gel matrix. For a second incubation with PKI(5-24) affinity-gel matrix, cAMP was added to a final concentration of 20  $\mu$ M. After washing of the material in the test tube, SDS sample buffer was added, heated to 95 °C and the supernatant loaded on to an 11% SDS gel.

### In-gel kinase-assay (according to [25])

PKI-eluted proteins were resolved by SDS/PAGE (11% gel) with 0.5 mg/ml BSA and either 0.5 mg/ml peptide or histone co-polymerized within the gel matrix. After electrophoresis the gel was incubated six times for 1 h each in 40 mM Hepes, pH 7.4, to allow partial renaturation of the proteins [25]. The phosphorylation reaction proceeded for 3 h in 25 mM Hepes, 10 mM MnCl<sub>2</sub> and 0.6 mCi of [ $\gamma$ -<sup>32</sup>P]ATP. Gels were washed for 12 h in 40 mM Hepes, pH 7.4, with 20 g of Dowex 20 and for 3 h in 40 mM Hepes, pH 7.4/1% sodium pyrophosphate, to remove residual [ $\gamma$ -<sup>32</sup>P]ATP. For PKI inhibition, the reaction was carried out in the presence of 1 mM PKI(5-24). Proteins were fixed in 10% methanol/10% acetic acid for 1 h. Radioactive label was detected by autoradiography on film and quantitatively analysed using a PhosphorImager (Fuji) and TINA software (raytest).

### MS analysis, peptide sequencing and determination of phosphorylated peptides

After transfer to PVDF membrane the protein was digested with trypsin (Promega) at 37 °C for 24 h in 1% Triton X-100/10% acetonitrile/100 mM Tris/HCl, pH 8. The resulting peptides were separated on a C<sub>18</sub> column (reversed-phase, aquapore OD-

300) with a gradient from 10 to 80% acetonitrile/0.085% trifluoroacetic acid. The flow rate was 100  $\mu$ l/min at 7 MPa (70 bar). Peak fractions were collected and examined using matrix-assisted laser-desorption ionization MS (MALDI MS). The matrix was 2,5-dihydroxybenzoic acid (10 mg/ml in 0.1% trifluoroacetic acid). Sequencing of selected peptides was done using an automatic protein sequencer model 477A (Applied Biosystems), based on Edman degradation.

Determination of phosphorylated peptides was done according to [26] using phosphate-selective mass chromatograms and mass spectra from the micro-liquid-chromatography electrospray ionization MS ( $\mu$ LC-ESI-MS) analysis of tryptic digests.

### Cell lines and maintenance

CHO cell line 10001, a derivative of a CHO Pro-5 strain, is the parent cell line of the 8-bromo-adenosine 3',5'-cyclic monophosphate (8-Br-cAMP)-resistant cell line 10260 [27]. Cells were grown at 37 °C under 5% CO<sub>2</sub> in mono-layer culture in  $\alpha$ -minimal essential medium supplemented with 10% fetal calf serum (Gibco) in a humidified incubator.

### Construction of the eukaryotic expression vector pSG5-C $\beta$ 2

A full-length clone of the C $\beta$ 2 isoform had been obtained from a bovine heart cDNA library [7]. To facilitate cloning the coding sequence was amplified by PCR to introduce *Bam*HI sites at the 5' and 3' ends of the amplification product. The resulting PCR product was gel-purified and subcloned into the *Eco*RV site of the pBluescript vector (Stratagene, Heidelberg, Germany), resulting in the plasmid pBS-C $\beta$ 2. The integrity of the reading frame was confirmed by dideoxynucleotide sequencing. To construct the expression vector pSG5-C $\beta$ 2, the C $\beta$ 2 insert was excised from plasmid pBS-C $\beta$ 2 with restriction endonuclease *Bam*HI and subsequently ligated into the *Bam*HI site of pSG5. Orientation of the insert was confirmed by restriction-endo-nuclease analysis.

### DNA transfection

CHO<sub>10260</sub> cells were transfected with vector pSG5-C $\beta$ 2 using the DNA/CaPO<sub>4</sub> precipitation technique [28]. The CaPO<sub>4</sub> precipitate was allowed to remain on the cells for 24 h before the precipitate was replaced by normal medium, and the cells were grown for 2 days. Then the cells were incubated for 14 days in selection medium containing 500  $\mu$ g/ml G-418, the medium being replaced every 3 days. The cell colonies were trypsin-treated and diluted to approx. 100 cells/ml in medium and the cells were allowed to settle on glass fragments. Glass fragments carrying one cell only were selected and these cells were maintained in culture. After screening for C $\beta$ 2 expression two out of 14 resistant colonies were analysed further.

### Preparation of cell lysates

Confluent cell cultures were washed twice in PBS after removal of the medium. The cells were incubated on ice with hypotonic buffer consisting of 10 mM Hepes, pH 7.4, 1 mM EDTA, 1 mM dithiothreitol, 50 mM NaF and protease-inhibitor cocktail. The cells were harvested, sonicated and centrifuged at 100 000 *g* in a TL100 ultracentrifuge rotor (Beckman).

### Indirect immunofluorescence of C subunits

Cells were grown to 10 000–30 000 cells/0.25 cm<sup>2</sup>. Cells were washed twice in PBS and fixed for 20 min in 0.5 or 2%

paraformaldehyde, or in methanol at –20 °C. The cells were permeabilized in 0.1% Triton X-100 in PBS for 10 min. After three washes in PBS (5 min each) the cells were incubated in 1% BSA in PBS. Incubation with the first antibody was for 1 h in PBS with 1% BSA, or with the antibody preincubated for 4–12 h in 1 mg/ml of the corresponding antigenic peptide. After sufficient washes a secondary antibody {goat anti-rabbit antibody conjugated to 5-([4,6-dichlorotriazin-2-yl]amino)fluorescein (DTAF) or Tricin} was added for 30 min, and washed as before.

## RESULTS

### Catalytic-subunit purification and C $\beta$ 2 immunodetection

For the immunodetection of C $\beta$ 2, antibodies against various regions of the C $\beta$ 2 N-terminus were raised. Best results in Western blotting and immunofluorescence were obtained with antibodies directed against residues 3–14 (Figure 1), designated anti-C $\beta$ 2(3–14). To generate peptide antibodies selective for either C $\alpha$  or C $\beta$ , which are 93% identical, regions with lower homology were inspected visually in the crystal structure of bovine recombinant C $\alpha$  [29] and chosen according to a high surface exposition. The sequence from 35 to 46 differs in six residues between C $\alpha$  and C $\beta$  (Figure 1) and forms an extended stretch on the surface connecting helix A with the conserved first  $\beta$ -strand in the glycine-rich flap of the enzyme. It overlaps four residues of the catalytic core [30]. The corresponding antibodies anti-C $\alpha$ (35–46) and anti-C $\beta$ (35–46) were highly selective and did not cross-react. C $\beta$ -selective antibodies raised against region 27–38 of the mouse protein have been reported previously [16].

Total C subunits were specifically purified from bovine heart tissues in the presence of cAMP and MgATP using high-affinity binding to the PKI(5–24) peptide [13]. Coomassie Brilliant Blue staining of an SDS/PAGE gel showed a major protein band migrating at 40 kDa (Figure 2A, lane 3), corresponding to the calculated molecular masses of the major isoenzymes bovine C $\alpha$

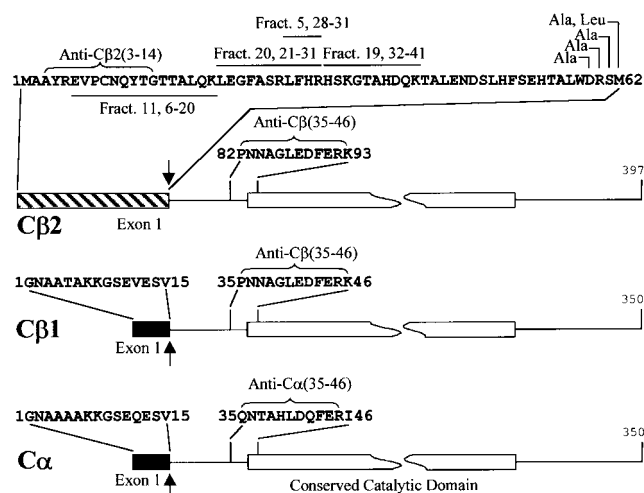

**Figure 1** Sequence alignments of C $\alpha$ , C $\beta$ 1 and C $\beta$ 2, and antigenic sites

Shown are the translated sequences of the different exons 1 from C $\beta$ 2, C $\beta$ 1 and C $\alpha$ . The splice sites between exon 1 and exon 2 for all three sequences are indicated. C $\beta$ 1 and C $\beta$ 2 differ only in their first exon. Also listed are the antigenic regions from specific sequences of C $\alpha$  and C $\beta$  residues 35–46, and from the unique C $\beta$ 2 N-terminus (residues 3–14). Indicated are the tryptic fractions of the C $\beta$ 2 N-terminus verified by MS (see the Results section). Four residues immediately before the splice site of C $\beta$ 2 were mutated, as shown, to Ala or Leu, with the aim of achieving some protection against proteolysis.

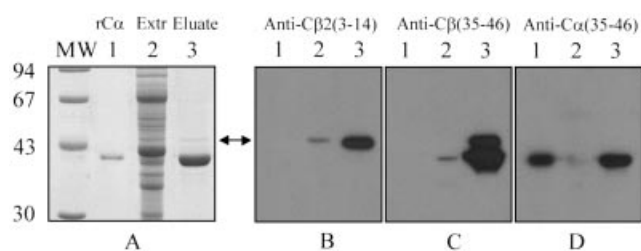

**Figure 2** Coomassie Brilliant Blue staining and immunodetection of PKA catalytic subunits  $C\alpha$ ,  $C\beta$  and  $C\beta 2$

Catalytic subunits were purified from cellular extracts of bovine heart tissue by PKI(5-24) affinity chromatography and applied to SDS/PAGE (11% gel) and Western blotting. All panels: lane 1, 0.5  $\mu$ g of recombinant bovine  $C\alpha$  (r $C\alpha$ ) as control; lane 2, cellular extract prior to PKI affinity chromatography; lane 3, total catalytic subunits eluted from the affinity column in the presence of 200 mM arginine. The double arrow indicates the position of the 46-kDa  $C\beta 2$  protein. (A) Coomassie Brilliant Blue stain; (B) immune reaction with the  $C\beta 2$ -selective antibody anti- $C\beta 2$ (3-14); (C)  $C\beta$ -selective immune reaction with anti- $C\beta$ (35-46); (D)  $C\alpha$ -selective immunodetection with anti- $C\alpha$ (35-46). The reaction of anti- $C\beta$ (35-46) with  $C\beta 2$  protein in cellular extract (C, lane 2), and of anti- $C\alpha$ (35-46) with  $C\alpha$  protein in the cellular extract (D, lane 2) is below or at the limit of sensitivity for these antibodies.

and  $C\beta 1$  (40859 and 40834 Da, respectively, including myristate and two phospho groups) which are both present in preparations of C subunits from cardiac tissue [11]. A minor protein band migrated at 46 kDa corresponding to the theoretical molecular mass of  $C\beta 2$  (46 268 Da, assuming two phosphorylated residues). It showed reactivity with anti- $C\beta 2$ (3-14) (Figure 2B, lanes 2 and 3) and also with anti- $C\beta$ (35-46) (Figure 2C, lane 3). It did not, however, react with the  $C\alpha$ -specific antibody [anti- $C\alpha$ (35-46), Figure 2D, lane 3]. Correspondingly, the major 40-kDa band showed reactivity with both  $C\alpha$ - and  $C\beta$ -specific antibodies (Figures 2C and 2D, lanes 3), but not with anti- $C\beta 2$ (3-14). We did not observe different migration behaviours for the  $C\alpha$  and  $C\beta 1$  subunits in our gel systems, as reported for these isoforms from mouse or hamster [14,31]. The murine  $C\beta 1$  protein, however, is 122 Da larger than its  $C\alpha$  counterpart, whereas the bovine  $C\beta 1$  is 25 Da smaller than bovine  $C\alpha$ . The 46-kDa anti- $C\beta 2$ (3-14) immunoreactive protein represents only  $2.5 \pm 0.2\%$  of the total  $C\alpha$  and  $C\beta 1$  C subunits in the eluate, estimated from density scans of Coomassie Brilliant Blue-stained SDS/polyacrylamide gels (shown in Figure 2A, lane 3). The small amount is not due to weaker binding of the 46-kDa protein to the PKI(5-24) peptide, as it co-eluted with  $C\alpha$ / $C\beta 1$  at matching concentrations of  $\geq 50$  mM arginine. A 46-kDa PKI(5-24)-binding and immunoreactive protein was also detected in porcine heart, in rat and mouse skeletal muscle, in turkey erythrocytes (results not shown), and in cells from the HeLa human cell line (see below).

Highly similar physicochemical properties ( $C\alpha$ ,  $C\beta 1$  and  $C\beta 2$  have pI values of 8.72, 8.79 and 8.72, respectively) prevented complete isolation of the 46-kDa protein from the other subunits. Further enrichment, however, was achieved using a salt gradient on material deprived of holoenzyme type I bound to DEAE-cellulose in the presence of cAMP. Low-ionic-strength potassium phosphate buffer containing cAMP led to the elution of a major portion of the bound 40-kDa C subunits, but apparently not of the 46-kDa protein. It did not elute until the ionic strength of the cAMP-containing buffer was raised above 80 mM potassium phosphate. After PKI(5-24) affinity chromatography, SDS/PAGE and transfer to PVDF membranes, the 46-kDa anti- $C\beta 2$ (3-14) immunoreactive protein was analysed further with MS.

**Table 1** MS of tryptic peptides from  $C\beta 2$

The masses of selected tryptic peptides were determined with MALDI MS as described and compared with theoretical masses of a  $C\beta 2$  tryptic digest. \*, Selected peptides were sequenced by Edman degradation for confirmation.

Peak fraction	Measured molecular mass (Da)	Theoretical molecular mass (Da)	Amino acid sequence	Position in the $C\beta 2$ sequence
2	516.6	515.61	DLLR	314–317
3*	843.7	842.91	FSEPHAR	185–191
5*	573.3	571.68	LFHR	28–31
6*	578.9	577.68	FGNLK	328–332
11	1653.5	1652.84	EVPCNQYGTGTTALQK	6–20
11	651.5	650.73	EDFLK	71–75
11	851.4	849.98	AKEDFLK	69–75
13	771.1	769.89	LEYAFK	153–158
16	1988.1	1987.12	KWENPAPNNAGLEDFER	76–92
19	1109.2	1108.18	HSKGTAFDQK	32–41
20	1331.4	1332.53	LEGFASRLFHR	21–31

### $C\beta 2$ identification by MS analysis and protein sequencing

MALDI MS resulted in the identification of the unique  $C\beta 2$  N-terminus (Table 1, peak fractions 5, 19, 20 and one of the peptides from peak fraction 11) and the  $C\beta$  body (peak fractions 13 and 16). In addition, peptides from the HPLC peak fractions 3, 5 and 6 were confirmed by Edman-degradation sequencing. This, in addition to the immunochemical evidence presented in Figure 2, confirms the identity of the 46-kDa immunoreactive protein and the  $C\beta 2$  gene product in PKI(5-24) affinity preparations from bovine heart.

Using mass-selective  $\mu$ LC-ESI MS, two phosphorylated  $C\beta 2$  peptides were identified, one containing Thr-244, the other Ser-385 (results not shown). Comparison with the  $C\alpha$  sequence showed that Thr-244 corresponds to Thr-197 in the activation segment, and that Ser-385 corresponds to Ser-338. Both are known phosphorylation sites in the  $C\alpha$  protein [32]. Phosphorylation of  $C\alpha$  Thr-197 is essential for catalytic activity [33,34]. The function of the phosphorylation of Ser-338 is not yet clear, but it may play a role in the stabilization of the enzyme [35].

### cAMP-dependent binding of $C\beta 2$ from cellular extracts to PKI(5-24) affinity-gel matrix

The role of holoenzyme dissociation by cAMP for isolation of  $C\beta 2$  by binding to the PKI(5-24) peptide was investigated. The experiment is based on the assumption that, in analogy to  $C\alpha$ , PKI(5-24) binding of  $C\beta 2$  requires catalytically active enzyme [33,34], and PKI(5-24) cannot compete with the regulatory subunits for C-subunit binding [36]. When cellular extracts were incubated with PKI(5-24) affinity-gel matrix in the presence of 0–100  $\mu$ M cAMP, the amount of  $C\beta 2$  that could be eluted correlated with the concentration of cAMP (Figure 3a). The experiment repeated with the corresponding supernatants in the presence of 20  $\mu$ M cAMP (Figure 3b), in order to mobilize any remaining C subunit, resulted in an inversely proportional elution of  $C\beta 2$ . Similar data were obtained for the 40-kDa C subunits (Figures 3c and 3d). This demonstrates that most of the  $C\beta 2$  protein in cellular extracts is not accessible by PKI(5-24) unless released by cAMP, which most probably indicates a  $C\beta 2$ -containing holoenzyme with regulatory subunits.

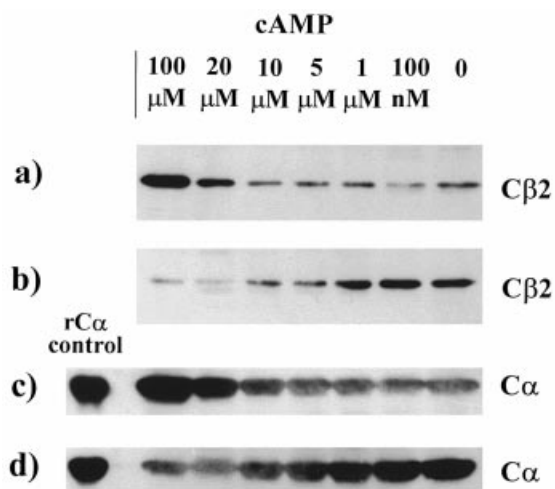

**Figure 3** cAMP-dependent binding of *Cβ2* to PKI(5-24)

Bovine heart homogenates (20 mg of protein) were incubated with 100  $\mu$ l of PKI(5-24) affinity agarose in the presence of 0–100  $\mu$ M cAMP as shown. The supernatants of the sedimented PKI(5-24) affinity agarose were incubated again with 100  $\mu$ l of PKI(5-24) affinity agarose and additional 20  $\mu$ M cAMP. Proteins bound to the PKI(5-24) affinity-gel matrix were eluted by heating in SDS sample buffer. Immunodetection was carried out on Western blots with antibodies anti-*Cβ2*(3-14) (**a**, **b**) and anti-*Cα* (**c**, **d**). Shown is the detection with the ECL system. (**a**) and (**c**) represent the immunoblot of the first incubation, (**b**) and (**d**) show the result of the second incubation. rC $\alpha$ , recombinant C $\alpha$ .

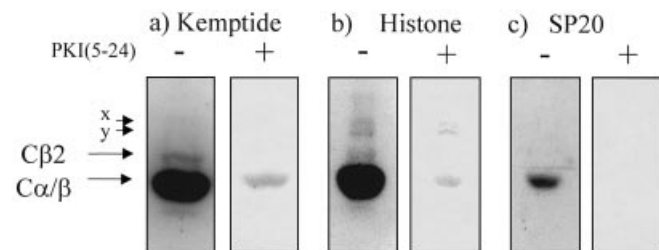
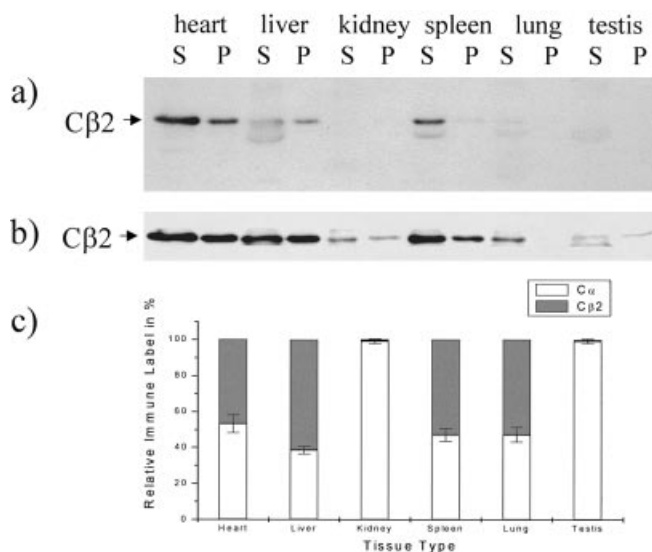

**Figure 4** Kinase activity in renatured SDS/PAGE

Catalytic subunits purified with PKI(5-24) affinity chromatography (a Coomassie Brilliant Blue stain of the eluate is shown in Figure 2A) were subjected to renaturing SDS/PAGE and an in-gel kinase assay. Co-polymerized within the gel matrix were putative substrates and BSA. Shown are autoradiograms of the different renaturing gels, each with the identically exposed PKI control to the right. For the inhibition with PKI(5-24), the peptide was added to the reaction at a concentration of 0.45 mM. The PKI(5-24)-incubated samples showed a lower background staining, possibly indicating the diffusion of renatured active kinase out of the gel during the assay. The substrates are Kemptide (**a**), histone II AS (**b**) and SP20 (**c**). x and y, unknown proteins.

### Protein-kinase activity of *Cβ2*

Owing to a lack of protocols for separation of *Cβ2* from *Cα/Cβ*, kinase activity of the *Cβ2* protein was tested in renatured SDS/polyacrylamide gels. For this purpose, Kemptide, histone II AS or SP20 peptide was co-polymerized in the gel (SP20 is a substrate peptide derived from PKI(5-24) [37]). Radioactivity detected at the position of *Cβ2* was highest with Kemptide (Figure 4a, –), but also significant with histone (Figure 4b, –). No radioactivity was detected with SP20 as a substrate at the position of *Cβ2*, possibly because it was below the detection limit (Figure 4c, –). PKI(5-24), when added during the incubation with [ $\gamma$ - $^{32}$ P]ATP, abolished the label at the positions corre-



**Figure 5** Immunodetection of *Cβ2* in different bovine tissues

Heart, liver, kidney, spleen, lung and testis were analysed for the presence of *Cβ2*. The tissue samples were homogenized, centrifuged at 10 000  $g$  and the resulting supernatants centrifuged again at 25 000  $g$ . These 25 000  $g$  pellets (20 mg; P) and the supernatants from a concomitant 130 000  $g$  centrifugation (20 mg; S) were subjected to small-scale PKI(5-24) purification. Shown is an immunoblot with the *Cβ2* antibody after SDS/PAGE (11% gel). Detection was carried out with the ECL system. (**a**) A moderate exposure time was used. Longer exposure time as shown in (**b**) allows the detection of *Cβ2* also in kidney, lung and testis (some unspecific protein staining also appeared). (**c**) A comparison in the same tissue samples of the immune signal for *Cα* with that of *Cβ2*, allowing an estimation of the relative ratio between these isoforms in different tissues. Because of the higher sensitivity of the anti-*Cβ2*(3-14) antibody compared with the anti-*Cα* antibody, the *Cβ2* signal is vastly over-represented in this analysis. Note that in bovine cardiac tissue the ratio between *Cβ2* and *Cα/Cβ* is only 0.025 at the level of Coomassie Brilliant Blue-stained protein (see Figure 2A). The error bars represent the S.D. from two experiments.

sponding to 40 and 46 kDa. The assay revealed two additional labelled bands at 56 and 60 kDa (y and x in Figure 4a), with no counterpart in Coomassie Brilliant Blue-stained gels (Figure 2A). They were especially active with histone, showed hardly any activity in the presence of Kemptide or SP20, but were only marginally inhibited by PKI(5-24), arguing against these two larger proteins being other PKA C subunits. The ratio of *Cβ2* activity relative to that of *Cα/Cβ* was 0.01–0.015 for Kemptide phosphorylation and 0.009 for histone phosphorylation (results not shown). Given a ratio of 0.025 for the relative amount of both isoforms (see Figure 2A), *Cβ2* and *Cα/Cβ* appear to have specific activities in a roughly similar range; these ratios, however, would be influenced by possible differences in isoenzyme renaturation. At the position of *Cβ2*, about 2.5% of the radioactivity measured in the presence of Kemptide was detected in the absence of specific kinase substrate with BSA only, probably indicating a small degree of autophosphorylation (about 3% in the case of *Cα/Cβ*; results not shown).

### Tissue distribution of *Cβ2*

The tissue-specific distribution of the *Cβ2* protein was investigated in different bovine organs. Soluble proteins from a 130 000  $g$  supernatant and proteins solubilized from 25 000  $g$  precipitates were analysed on the basis of small-scale PKI(5-24) purification plus immunostaining. The highest relative amounts of *Cβ2* protein were detected in the soluble fractions from heart, liver and spleen (Figure 5a). In the pellet fractions, heart and liver

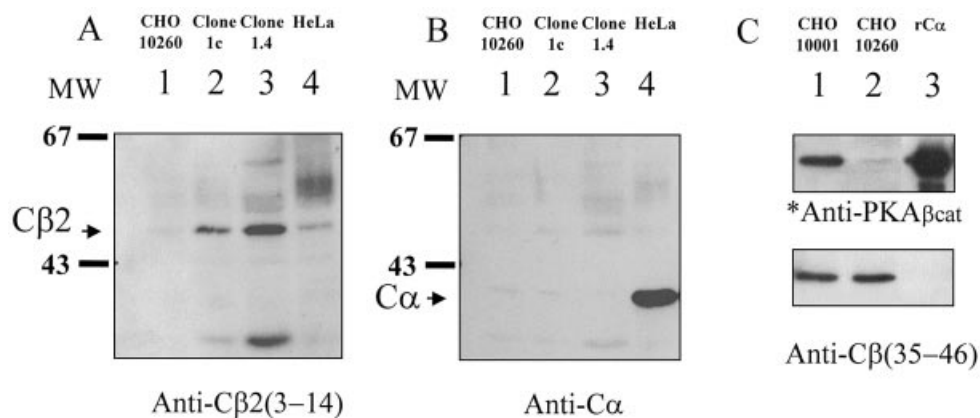

**Figure 6** Immunodetection of *Cβ2* and *Cα* in cell lysates from mutant CHO and wild-type HeLa cells

Cell line CHO<sub>10260</sub> and its derivatives CHO<sub>1c</sub> and CHO<sub>1.4</sub>, which are transfected with a *Cβ2*-containing vector, and HeLa cells were lysed in hypotonic buffer, sonicated and centrifuged at 130 000 *g*. The respective supernatants (900  $\mu$ g) were applied to 100  $\mu$ l of PKI(5-24) affinity agarose according to the small-scale batch procedure and analysed after resolution on SDS/PAGE (11% gel) and transfer to PVDF membrane with antibodies anti-*Cβ2*(3-14) (**A**), anti-*Cα* (**B**), anti-PKA <sub>$\beta$ cat</sub> (**C**, upper panel) and anti-*Cβ*(35-46) (**C**, lower panel). \*, The commercial antibody anti-PKA <sub>$\beta$ cat</sub> recognizes *Cα* and *Cβ* equally well. The positions of *Cβ2* and *Cα* are indicated. Note the presence of a lower-molecular-mass product cross-reacting with the antibody in clones CHO<sub>1c</sub> and CHO<sub>1.4</sub> (**A**, lanes 2 and 3). The immunostain with anti-*Cβ2*(3-14) indicates a C-terminal degradation of the overexpressed protein. For better comparison of the C-subunit positions, the blot from (**A**) was stripped of antibodies and was incubated a second time with the anti-*Cα* antibody (**B**). Note the faint residues of the preceding *Cβ2*-specific immunostaining on the blot in (**B**).

showed relatively high amounts, while the amount in the spleen pellet fraction was significantly lower. In fractions from kidney, lung and testis the detection of *Cβ2* required longer exposition of film with the ECL-treated membrane (Figure 5b). As *Cα* mRNA expression is regarded as being fairly uniform throughout different tissues [4,9,10,38], the relation of *Cβ2* staining to *Cα* staining was used as an independent measure for the *Cβ2* levels in certain tissues. In relation to *Cα*, kidney and testis showed the lowest levels of *Cβ2* immunoreactivity (Figure 5c), while in the other tissues the *Cβ2*/*Cα* ratio was quite similar. Overall, bovine lung tissue appears to have the lowest total amount of catalytic subunits.

### *Cβ2* overexpression in CHO<sub>10260</sub> cells

To study *Cβ2* overexpression in a living cell, we introduced the gene into the cAMP-resistant cell line CHO<sub>10260</sub>, which was originally derived from CHO<sub>10001</sub> [27], a cell line found to transcribe the *Cβ2* gene [17]. Two independent *Cβ2*-expressing clones, designated CHO<sub>1c</sub> and CHO<sub>1.4</sub>, were used for further studies. *Cβ2* was most highly expressed in CHO<sub>1.4</sub> (Figure 6A, lane 3), to a slightly lesser extent in clone CHO<sub>1c</sub> (Figure 6A, lane 2). A faint band indicates the presence of native *Cβ2* in the untransfected mutant cell line CHO<sub>10260</sub> and in HeLa cells, corroborating the detection of *Cβ2* mRNA in CHO cells and in a number of human cell lines in a previous study [17]. To detect *Cα* in CHO cells, the specific anti-*Cα*(35-46) antibody could not be used, because of differences in the antigenic sequence 35-46 in three central positions between cattle and hamster. Antibody anti-*Cα*(35-46) thus does not recognize *Cα* from hamster (results not shown). Therefore, we used the commercial antibody anti-PKA <sub>$\beta$ cat</sub>, which recognizes *Cα* and *Cβ* equally well. The reduction in the amount of *Cα* protein in the CHO<sub>10260</sub> mutant compared with wild-type CHO<sub>10001</sub> (Figure 6C) or HeLa (Figure 6B) cells is clearly demonstrated with the anti-PKA <sub>$\beta$ cat</sub> immunostain, and confirms earlier findings [39,40]. The amount of *Cβ1*, as detected by the anti-*Cβ*(35-46) antibody, was not negatively affected in CHO<sub>10260</sub> cells (Figure 6C). The weak stain at 40 kDa by the anti-PKA <sub>$\beta$ cat</sub> antibody in the CHO<sub>10260</sub> preparation (Figure 6C, upper

panel) represents *Cβ1*, possibly in addition to a small amount of *Cα*. Thus the actual amount of *Cα* in the mutant cell line may be lower than regarded previously [39,40].

### *Cβ2* distribution in CHO cells

The expression of the *Cβ2* protein in the CHO clones was also demonstrated by immunofluorescence using antibody anti-*Cβ2*(3-14). The mutant cell line CHO<sub>10260</sub> showed a weak immunofluorescence (Figure 7a), erasable by co-incubation with the corresponding antigenic peptide *Cβ2*(3-14) (Figure 7b). The *Cβ2*-overexpressing clone CHO<sub>1c</sub> gave a strong uniformly distributed signal [Figure 7c; Figure 7e shows 4,6-diamidino-2-phenylindole (DAPI)-stained nuclei] in both the cytoplasm and the nucleus, indicating the presence of the *Cβ2* protein in both compartments. Again, the antigenic peptide *Cβ2*(3-14) erased most of the fluorescence (Figure 7d). Stimulation of the cells with forskolin or isoproterenol, substances used to increase the intracellular cAMP level in order to dissociate holoenzyme, did not lead to significant differences in the distribution of the enzyme (results not shown).

### cAMP response of CHO cells transfected with *Cβ2*

The cell line CHO<sub>10260</sub> is described as cAMP-resistant with regard to morphological changes and growth effects [27]. We examined the effect of 1 mM 8-Br-cAMP or 1 mM dibutyryl-cAMP on the cell lines CHO<sub>10260</sub>, CHO<sub>10001</sub>, CHO<sub>1c</sub> and CHO<sub>1.4</sub>. The parental CHO<sub>10001</sub> and the mutant cell line CHO<sub>10260</sub> both had doubling times of 12 h in the absence of cAMP stimulation (Table 2). Upon addition of the cAMP derivatives the wild-type CHO<sub>10001</sub> stopped growth during the 48 h examined, while CHO<sub>10260</sub> increased its doubling time to 20 h as reported before [41]. These effects were identical for both 8-Br-cAMP and dibutyryl-cAMP. The *Cβ2*-overexpressing cell lines CHO<sub>1c</sub> and CHO<sub>1.4</sub>, however, showed no cAMP-dependent effect on growth rate; their increase in doubling time to 20 h in both the absence and presence of cAMP derivatives may be a consequence of the expression system which requires G-418 in the growth medium.

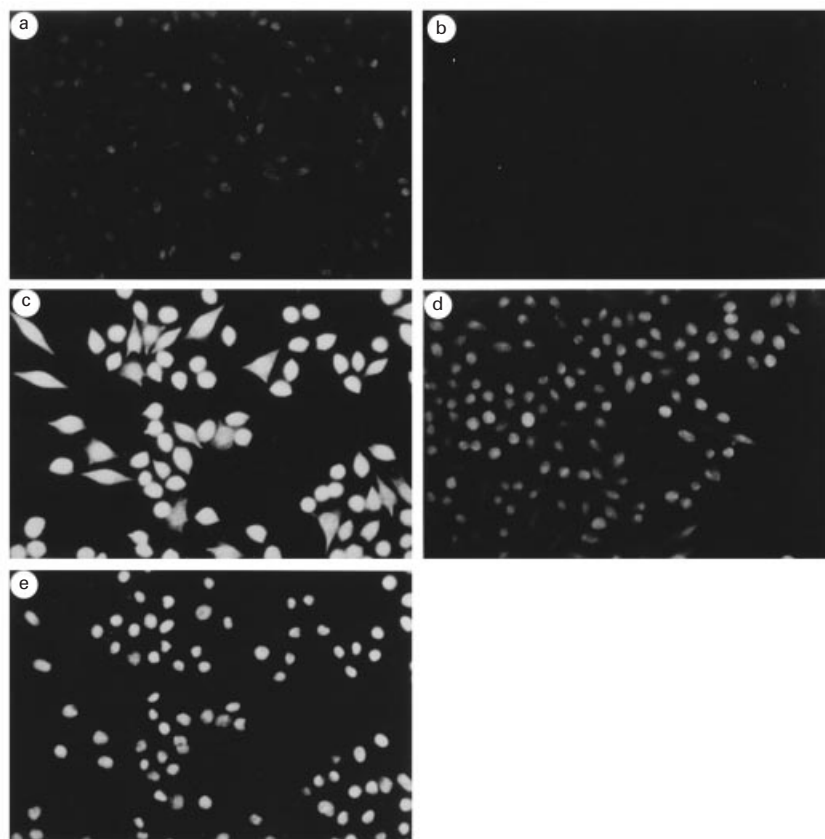

**Figure 7** Immunofluorescence of  $CHO_{10260}$  and clone  $CHO_{1c}$

Cells of  $CHO_{10260}$  and clone  $CHO_{1c}$  were fixed in 3% paraformaldehyde, and permeabilized in 0.1% Triton X-100. Cells were immunostained with anti- $C\beta 2(3-14)$  and an FITC-coupled secondary antibody. (a) Immunofluorescence of  $CHO_{10260}$ ; (b) immunofluorescence of  $CHO_{10260}$ , but antibody preincubated in the presence of antigenic peptide  $C\beta 2(3-14)$ ; (c) immunofluorescence of clone  $CHO_{1c}$ ; (d) immunofluorescence of clone  $CHO_{1c}$ , but antibody preincubated in the presence of antigenic peptide  $C\beta 2(3-14)$ ; (e) 4,6-diamidino-2-phenylindole (DAPI)-stained nuclei of the cells in (c).

**Table 2** Phenotype of  $CHO_{10001}$ ,  $CHO_{10260}$  and  $C\beta 2$ -overexpressing  $CHO_{10260}$  cells

The relative amount of protein was detected by immunostaining with selective antibodies (see Figure 6). nd, not determined.

Cell line	Doubling time (h)		Cell morphology		Kinase activity	Protein
	No cAMP	With cAMP	No cAMP	With cAMP		
Wild-type $CHO_{10001}$	12	$\infty$	Normal	Spindle-shaped cells, cells aligned, smoothing of membranes	100%	40 kDa, + + + ; $C\beta$ , + + + ; $C\beta 2$ , nd
Mutant $CHO_{10260}$	12	20	Normal	Normal	$\approx 10\%$	40 kDa, + ; $C\beta$ , + + + ; $C\beta 2$ , +
$CHO_{1c}$ pSG5- $C\beta 2$	20	20	Rounded and aligned, smooth membranes	Less rounded, spindle-shaped, aligned, smooth membranes	$\approx 10\%$	40 kDa, + ; $C\beta 2$ , + + +
$CHO_{1.4}$ pSG5- $C\beta 2$	20	20	Rounded and aligned, smooth membranes	Less rounded, spindle-shaped, aligned, smooth membranes	$\approx 10\%$	40 kDa, + ; $C\beta 2$ , + + +

Morphological changes were monitored 2 h after addition of 8-Br-cAMP (Figure 8). As expected, no morphological changes were seen in  $CHO_{10260}$  (Figures 8a and 8b, Table 2). In contrast, the morphology of  $CHO_{10001}$  was altered dramatically (Figures 8c and 8d). The cells became spindle-shaped and aligned with each other. Similar morphological changes, only slightly less pronounced, were observed in the  $C\beta 2$ -overexpressing cell lines  $CHO_{1c}$  (Figures 8e and 8f) and  $CHO_{1.4}$  (Figures 8g and 8h). 8-Br-

cAMP had the strongest effect on  $CHO_{1.4}$ , corresponding to the higher expression of  $C\beta 2$  in these cells (Figure 6A, lanes 2 and 3). In contrast to the  $CHO_{10260}$  or  $CHO_{10001}$  cultures, the unstimulated cultures of cell lines  $CHO_{1.4}$  and  $CHO_{1c}$  contained more spherical cells. Furthermore, the  $C\beta 2$ -overexpressing cells appeared more elongated, with smoother membranes than  $CHO_{10260}$ . The spherical cells did not seem to represent mitotic cells and remained adherent. The number of spherical cells,

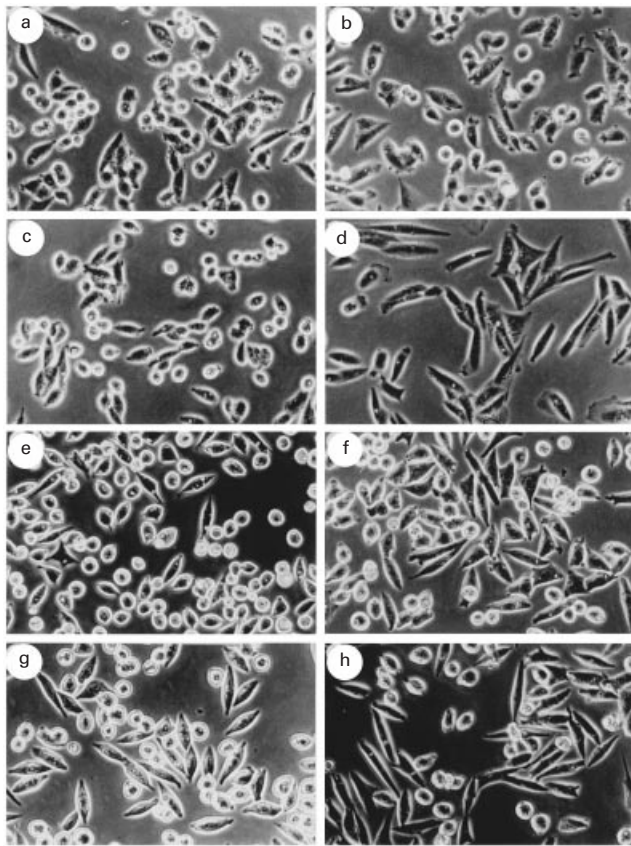

**Figure 8** Effect of 1 mM 8-Br-cAMP on cell lines CHO<sub>10260</sub>, CHO<sub>10001</sub>, CHO<sub>1.4</sub> and CHO<sub>1c</sub>.

Cells were plated with 20 000 cells/cm<sup>2</sup>. After 24 h, 1 mM 8-Br-cAMP was added to the cultures shown on the right (b, d, f, h). The photographs were taken 2 h after incubation in 8-Br-cAMP together with the control cultures without additives (a, c, e, g). (a, b) CHO<sub>10260</sub>; (c, d) CHO<sub>10001</sub>; (e, f) CHO<sub>1c</sub>; (g, h) CHO<sub>1.4</sub>.

however, decreased after addition of cAMP derivatives. To examine whether the level of PKA activity was responsible for this phenotype, kinase activity was measured in cellular extracts in the presence and absence of cAMP. CHO<sub>10260</sub> had about 10% of the kinase activity of CHO<sub>10001</sub> (Table 2), as reported elsewhere [27]. However, no increase in activity due to the overexpression of *Cβ2* was observed for the clones CHO<sub>1.4</sub> and CHO<sub>1c</sub> (results not shown).

## DISCUSSION

### Enzyme characterization and purification

It was demonstrated that the *Cβ2* splice variant of the *Cβ* catalytic subunit is translated into protein in mammalian tissue. Its identity was confirmed by MS, peptide sequencing and antibody detection. *Cβ2* was partially purified from cardiac tissue; further enrichment was prevented by the predominance of *Cα* and *Cβ1*. *Cβ2* has a very low relative abundance (2.5% of total C subunit in heart muscle with the highest *Cβ2* level). It is, however, clearly detectable in preparations from cardiac tissue simply by Coomassie Brilliant Blue staining of SDS/polyacrylamide gels, raising the question of why *Cβ2* was not detected earlier. Besides the low abundance of *Cβ2*, and a high physicochemical similarity to *Cα* and *Cβ1*, there may be another

reason. In traditional purification methods *Cα* and *Cβ1* are released at low ionic strength from a holoenzyme II complex bound to DEAE anion exchanger by cAMP [23,42]. *Cβ2* did not elute under these conditions unless the ionic strength was raised above 80 mM potassium phosphate. Therefore, *Cβ2* is absent from most conventional C-subunit preparations. The reason for the deferred elution is not clear, but may be due to a salt-dependent association with as-yet unknown interacting molecules which remain bound to the column. A direct effect of the DEAE matrix is unlikely, as PKI(5-24) affinity-purified C subunits showed matching elution behaviours from a variety of ion-exchanger materials tested (results not shown).

The *Cβ2* protein has kinase activity comparable with that of *Cα/Cβ* in renatured SDS/polyacrylamide gels, and the activity is inhibited by PKI [also demonstrated by its PKI(5-24)-binding capacity]. *Cβ2* release is cAMP-concentration-dependent. Together with its cAMP-dependent extraction from tissue homogenate deprived of holoenzyme I, this suggests the existence of an RII/*Cβ2* holoenzyme, not excluding an RI/*Cβ2* holoenzyme.

The catalytic subunit of PKA contains two (auto-)phosphorylation sites [32], which until recently were regarded as constitutive, but which actually may play a role in kinase maturation and regulation [43,44]. The phosphorylation of Thr-197 of *Cα* is important for binding regulatory subunits, interacting with the protein kinase inhibitor and kinase activity [33,34,35,45]. Phosphorylation sites at the homologous positions in the *Cβ2* protein (Thr-244 and Ser-385) were detected by MS. It is reasonable that these phosphorylation sites have similar functions in *Cα* and *Cβ2*. The recombinant *Cα* protein, when expressed in bacteria, can also be autophosphorylated on amino acids Ser-10 and Ser-139 [35], but a physiological function is so far unknown. From comparisons of sequence homology, a phosphorylation equivalent to that of Ser-139 in recombinant *Cα* would be possible in *Cβ2*, but was not detected in this study.

### Expression of recombinant *Cβ2*

The isolation of individual C isoforms from mammalian tissue is extremely difficult and has not yet been achieved for the much more abundant forms *Cα* and *Cβ1* (preparations from striated muscle contain both *Cα* and *Cβ1* [11]). *Cα* and *Cβ1*, however, have been purified successfully from recombinant sources [13,14]. Bacterial expression of *Cβ2* according to established procedures [12,14,29,33,34] demonstrated a high proteolytic susceptibility of the *Cβ2* N-terminus, which could not be circumvented by mutagenizing residues around the cleavage sites (mutations indicated in Figure 1; F. Gesellchen and D. Bossemeyer, unpublished work). A minor C-terminal truncation was also observed in *Cβ2*-overexpressing CHO cells. As degradation is not being observed during heterologous expression of *Cα*, the proteolytic susceptibility of the *Cβ2* N-terminus may indicate a particularly accessible and flexible conformation of this unique domain, such as a loop structure or a hinge region.

### Tissue distribution of *Cβ2*

Using a specific antibody [anti-*Cβ2*(3-14)] we detected the *Cβ2* protein in all bovine tissues examined, although at very different levels. The observed *Cβ2* levels correlate well with the results from Northern-blot hybridization of *Cβ2* transcripts and PCR reactions in bovine tissue made earlier [7]. The level of *Cβ2* also correlates with the relative amount of *Cβ1* mRNA in different tissues [5,9,10,38]. This is supported by the similarity of the ratios of *Cα* mRNA to *Cβ1* mRNA indicated in the literature, and the ratio of *Cβ2* to *Cα* from this study. This suggests that a relatively constant proportion of the *Cβ* transcript is alternatively spliced



to C $\beta$ 2 and C $\beta$ 1 mRNA, independent of a tissue-specific level of C $\beta$ 1 mRNA. The amount of C $\beta$ 2 protein appears not to be regulated independently of the level of C $\beta$ 1 or C $\beta$ 2 transcription.

In addition to cattle, a C $\beta$ 2 immunospecific 46-kDa protein was detected in other mammals (pig, rat and mouse, and in HeLa cells) and in one non-mammalian species (turkey) after PKI(5-24) affinity chromatography. The C $\beta$ 2 protein thus appears to be present ubiquitously in mammals and probably also in birds. The fact that an antibody which was generated against the N-terminal bovine sequence recognized a 46-kDa protein in these other species argues for a rather conserved C $\beta$ 2 exon 1.

### CHO-cell transfection with C $\beta$ 2

CHO<sub>10260</sub> cells expressed the bovine C $\beta$ 2 gene after stable transfection. C $\beta$ 2 was diffusely distributed between the cytoplasmic and the nuclear compartments. No change in the overall localization was visible after treatment with forskolin or isoproterenol. The movement of free catalytic subunit into the nucleus is well established [46,47]. The translocation, however, does not necessarily become apparent in CHO cells using immunocytochemistry, as immunostaining of CHO cells with an antibody directed against bovine 40-kDa C subunits did not indicate a nuclear enrichment in fluorescence after stimulation [39]. The C $\alpha$  protein has been shown to enter the nucleus by diffusion despite its size of 40 kDa [47]. The possibility cannot be excluded that C $\beta$ 2, although 6 kDa larger, can enter the nuclear compartment in the same way. The question of a cAMP-dependent specific translocation of C $\beta$ 2 into the nucleus, in analogy to C $\alpha$ , remains to be answered. Micro-injection studies with a purified C $\beta$ 2 subunit into living cells are thus our future goal.

The cAMP-resistant phenotype of CHO<sub>10260</sub> is caused by a reduction in PKA activity [27] and a decrease in immunoreactive C subunit [39]. The molecular reason for this phenotype appears to be a decrease in the amount of C $\alpha$  mRNA [40]. No decrease in the level of C $\beta$ 1 was observed in the mutant cell line in our study, supported by an unaltered level of C $\beta$ 1 mRNA [40]. C $\beta$ 1 thus does not appear to contribute significantly to the cAMP-responsive phenotype, nor to total PKA activity, indicated by the low level of kinase activity in CHO<sub>10260</sub> ([27] and this study). Both C $\beta$ 1 and C $\alpha$  isoforms have similar abilities to phosphorylate synthetic substrates *in vitro* [13,14]. Howard et al. [40] discuss the following reasons for the missing contribution of C $\beta$ 1 to the cAMP response and low kinase activity in CHO<sub>10260</sub> cells: (i) C $\beta$  may be less efficiently translated than C $\alpha$ , (ii) C $\beta$ 1 may not efficiently associate with regulatory subunits, or (iii) the C $\beta$ 1 protein may be less stable than C $\alpha$ . Indeed, C $\beta$ 1 shows a 5-fold higher sensitivity of the type-II holoenzyme containing C $\beta$ 1 to cAMP [14], but this observation fails to explain the low level of kinase activity in CHO<sub>10260</sub>. The strong reduction in C $\alpha$ /C $\beta$  immunostaining in contrast to the absence of any reduction in C $\beta$ 1 immunostaining in CHO<sub>10260</sub> indicates a very low abundance of C $\beta$ 1 in the CHO cells, perhaps insufficient to produce a cAMP-responsive phenotype in the absence of C $\alpha$ . Considerable overexpression of C $\beta$ 2 in clones CHO<sub>1,4</sub> and CHO<sub>1c</sub>, however, failed to increase the level of kinase activity, at least within the detection range. The activity of C $\beta$ 2 *in vivo* thus may be impeded by cellular factors independent of the level of cAMP. Despite this lack of a measurable increase in kinase activity, C $\beta$ 2 overexpression in CHO<sub>1,4</sub> and CHO<sub>1c</sub> clearly produced significant physiological effects. Most of the cAMP-related morphological changes of the wild type were restored. However, a growth arrest, as observed in CHO<sub>10001</sub> after addition of cAMP ana-

logues, was not achieved. Apparently C $\beta$ 2, when expressed in CHO<sub>10260</sub> cells, mimics some but not all of the cellular functions of C $\alpha$ . Two possibilities remain. (i) If C $\beta$ 2 is overexpressed in CHO<sub>10260</sub> to a level intermediate between the (low) level of C $\beta$ 1 and the level of C $\alpha$  in the wild type, it may trigger an intermediate cAMP response in a dose-dependent manner. (ii) The effects on cell morphology and on the growth rate are mediated by different C isoforms. At present, we cannot distinguish between these possibilities.

Another interesting feature of the C $\beta$ 2-expressing cells is the occurrence of a rounded phenotype, not seen in wild-type CHO<sub>10001</sub> or CHO<sub>10260</sub>. Cell rounding is known from a variety of cell lines as a consequence of an intracellular increase in cAMP [48,49], or following the micro-injection of the free catalytic subunit [50]. In Y1 cells, rounding is a consequence of very rapid tyrosine dephosphorylation of a focal-adhesion protein, paxillin, which was shown to be an early downstream target of PKA signalling, causing disassembly of focal adhesions [49]. When, on a speculative basis, a similar mechanism of rounding is assumed in the C $\beta$ 2-overexpressing CHO cells, this pathway would then be activated by C $\beta$ 2 independent of the level of kinase activity, conceivably through a C $\beta$ 2-N-terminus-dependent colocalization of C $\beta$ 2 with downstream targets.

Taken together, C $\beta$ 2 is a ubiquitously expressed protein that shares a number of features with the common C $\alpha$  and C $\beta$ 1 isoenzymes, such as its regulation by PKI and cAMP, as well as its conserved phosphorylation sites. Expression studies in a C $\alpha$  mutant cell line, however, hint at functions of C $\beta$ 2 beyond the function of the major splice form C $\beta$ 1.

The technical assistance of Norbert König and James Richard is gratefully acknowledged. We thank Dr Jennifer Reed for semantic help with the manuscript, and Dr Paul Jedrzejewski, Dr Martina Schnölzer, Dr Wolf Lehmann and Dr Hans Heid for MS analysis and microsequencing; peptides were synthesized by Dr Rüdiger Pipkorn and Dr H. R. Rackwitz (all DKFZ, Heidelberg, Germany). This work was supported by the Deutsche Forschungsgemeinschaft.

### REFERENCES

- Montminy, M. (1997) Transcriptional regulation by cyclic AMP. *Annu. Rev. Biochem.* **66**, 807–822
- Shoji, S., Parmelee, D. C., Wade, R. D., Kumar, S., Ericsson, L. H., Walsh, K. A., Neurath, H., Long, G. L., Demaille, J. G., Fischer, E. H. and Titani, K. (1981) Complete amino acid sequence of the catalytic subunit of bovine cardiac muscle cyclic AMP-dependent protein kinase. *Proc. Natl. Acad. Sci. U.S.A.* **78**, 848–851
- Shoji, S., Ericsson, L. H., Walsh, K. A., Fischer, E. H. and Titani, K. (1983) Amino acid sequence of the catalytic subunit of bovine type II adenosine cyclic 3',5'-phosphate dependent protein kinase. *Biochemistry* **22**, 3702–3709
- Showers, M. O. and Maurer, R. A. (1986) A cloned bovine cDNA encodes an alternate form of the catalytic subunit of cAMP-dependent protein kinase. *J. Biol. Chem.* **261**, 16288–16291
- Uhler, M. D., Chrivia, J. C. and McKnight, G. S. (1986) Evidence for a second isoform of the catalytic subunit of cAMP-dependent protein kinase. *J. Biol. Chem.* **261**, 15360–15363
- Beebe, S. J., Oyen, O., Sandberg, M., Froya, A., Hansson, V. and Jahnsen, T. (1990) Molecular cloning of a tissue-specific protein kinase (C gamma) from human testis – representing a third isoform for the catalytic subunit of cAMP-dependent protein kinase. *Mol. Endocrinol.* **4**, 465–475
- Wiemann, S., Kinzel, V. and Pyerin, W. (1991) Isoform C beta 2, an unusual form of the bovine catalytic subunit of cAMP-dependent protein kinase. *J. Biol. Chem.* **266**, 5140–5146
- Wiemann, S., Kinzel, V. and Pyerin, W. (1992) Cloning of the C alpha catalytic subunit of the bovine cAMP-dependent protein kinase. *Biochim. Biophys. Acta* **1171**, 93–96
- Shuntoh, H., Sakamoto, N., Matsuyama, S., Saitoh, M. and Tanaka, C. (1992) Molecular structure of the C beta catalytic subunit of rat cAMP-dependent protein kinase and differential expression of C alpha and C beta isoforms in rat tissues and cultured cells. *Biochim. Biophys. Acta* **1131**, 175–180
- Guthrie, C. R., Skalhegg, B. S. and McKnight, G. S. (1997) Two novel brain-specific splice variants of the murine C beta gene of cAMP-dependent protein kinase. *J. Biol. Chem.* **272**, 29560–29565

- 11 Jedrzejewski, P. T., Girod, A., Tholey, A., Konig, N., Thullner, S., Kinzel, V. and Bossemeyer, D. (1998) A conserved deamidation site at Asn 2 in the catalytic subunit of mammalian cAMP-dependent protein kinase detected by capillary LC-MS and tandem mass spectrometry. *Protein Sci.* **7**, 457–469
- 12 Slice, L. W. and Taylor, S. S. (1989) Expression of the catalytic subunit of cAMP-dependent protein kinase in *Escherichia coli*. *J. Biol. Chem.* **264**, 20940–20946
- 13 Olsen, S. R. and Uhler, M. D. (1989) Affinity purification of the C alpha and C beta isoforms of the catalytic subunit of cAMP-dependent protein kinase. *J. Biol. Chem.* **264**, 18662–18666
- 14 Gamm, D. M., Baude, E. J. and Uhler, M. D. (1996) The major catalytic subunit isoforms of cAMP-dependent protein kinase have distinct biochemical properties *in vitro* and *in vivo*. *J. Biol. Chem.* **271**, 15736–15742
- 15 Huang, Y. Y., Kandel, E. R., Varshavsky, L., Brandon, E. P., Qi, M., Idzerda, R. L., McKnight, G. S. and Bourtschouladze, R. (1995) A genetic test of the effects of mutations in PKA on mossy fiber LTP and its relation to spatial and contextual learning. *Cell* **83**, 1211–1222
- 16 Qi, M., Zhuo, M., Skalhegg, B. S., Brandon, E. P., Kandel, E. R., McKnight, G. S. and Idzerda, R. L. (1996) Impaired hippocampal plasticity in mice lacking the Cbeta1 catalytic subunit of cAMP-dependent protein kinase. *Proc. Natl. Acad. Sci. U.S.A.* **93**, 1571–1576
- 17 Wiemann, S., Steuer, B., Alonso, A., Kinzel, V. and Pyerin, W. (1996) Promoter of the gene encoding the bovine catalytic subunit of cAMP-dependent protein kinase isoform C beta 2. *Biochim. Biophys. Acta* **1309**, 211–220
- 18 Thomis, D. C., Floyd Smith, G. and Samuel, C. E. (1992) Mechanism of interferon action. cDNA structure and regulation of a novel splice-site variant of the catalytic subunit of human protein kinase A from interferon-treated human cells. *J. Biol. Chem.* **267**, 10723–10728
- 19 Shoji, S., Hayashi, M., Funakoshi, T. and Kubota, Y. (1986) Rapid identification of NH<sub>2</sub>-terminal myristyl peptides by reversed-phase high-performance liquid chromatography. *J. Chromatogr.* **356**, 179–185
- 20 Clegg, C. H., Ran, W., Uhler, M. D. and McKnight, G. S. (1989) A mutation in the catalytic subunit of protein kinase A prevents myristylation but does not inhibit biological activity. *J. Biol. Chem.* **264**, 20140–20146
- 21 Silverman, L. and Resh, M. D. (1992) Lysine residues form an integral component of a novel NH<sub>2</sub>-terminal membrane targeting motif for myristylated pp60v-src. *J. Cell Biol.* **119**, 415–425
- 22 Gangal, M., Clifford, T., Deich, J., Cheng, X. D., Taylor, S. S. and Johnson, D. A. (1999) Mobilization of the A-kinase N-myristate through an isoform-specific intermolecular switch. *Proc. Natl. Acad. Sci. U.S.A.* **96**, 12394–12399
- 23 Nelson, N. C. and Taylor, S. S. (1981) Differential labeling and identification of the cysteine-containing tryptic peptides of catalytic subunit from porcine heart cAMP-dependent protein kinase. *J. Biol. Chem.* **256**, 3743–3750
- 24 Kinzel, V., Hotz, A., Konig, N., Gagemann, M., Pyerin, W., Reed, J., Kubler, D., Hofmann, F., Obst, C., Gensheimer, H. P. et al (1987) Chromatographic separation of two heterogeneous forms of the catalytic subunit of cyclic AMP-dependent protein kinase holoenzyme type I and type II from striated muscle of different mammalian species. *Arch. Biochem. Biophys.* **253**, 341–349
- 25 Geahlen, R. L. and Harrison, M. L. (1986) Detection of a novel lymphocyte protein-tyrosine kinase by renaturation in polyacrylamide gels. *Biochem. Biophys. Res. Commun.* **134**, 963–969
- 26 Jedrzejewski, P. T. and Lehmann, W. D. (1997) Detection of modified peptides in enzymatic digests by capillary liquid-chromatography electrospray mass-spectrometry and a programmable skimmer CID acquisition routine. *Anal. Chem.* **69**, 294–301
- 27 Gottesman, M. M., LeCam, A., Bukowski, M. and Pastan, I. (1980) Isolation of multiple classes of mutants of CHO cells resistant to cyclic AMP. *Somatic. Cell Genet.* **6**, 45–61
- 28 Chen, C. A. and Okayama, H. (1988) Calcium phosphate-mediated gene transfer: a highly efficient transfection system for stably transforming cells with plasmid DNA. *Biotechniques* **6**, 632–638
- 29 Engh, R. A., Girod, A., Kinzel, V., Huber, R. and Bossemeyer, D. (1996) Crystal structures of catalytic subunit of cAMP-dependent protein kinase in complex with isoquinolinesulfonyl protein kinase inhibitors H7, H8, and H89. Structural implications for selectivity. *J. Biol. Chem.* **271**, 26157–26164
- 30 Hanks, S. K. and Quinn, A. M. (1991) Protein kinase catalytic domain sequence database: identification of conserved features of primary structure and classification of family members. *Methods Enzymol.* **200**, 38–62
- 31 Razani, B., Rubin, C. S. and Lisanti, M. P. (1999) Regulation of cAMP-mediated signal transduction via interaction of caveolins with the catalytic subunit of protein kinase A. *J. Biol. Chem.* **274**, 26353–26360
- 32 Shoji, S., Titani, K., Demaille, J. G. and Fischer, E. H. (1979) Sequence of two phosphorylated sites in the catalytic subunit of bovine cardiac muscle adenosine 3',5'-monophosphate-dependent protein kinase. *J. Biol. Chem.* **254**, 6211–6214
- 33 Steinberg, R. A., Cauthron, R. D., Symcox, M. M. and Shuntoh, H. (1993) Autoactivation of catalytic (C alpha) subunit of cyclic AMP-dependent protein kinase by phosphorylation of threonine 197. *Mol. Cell. Biol.* **13**, 2332–2341
- 34 Girod, A., Kinzel, V. and Bossemeyer, D. (1996) *In vivo* activation of recombinant cAPK catalytic subunit active site mutants by coexpression of the wild-type enzyme, evidence for intermolecular cotranslational phosphorylation. *FEBS Lett.* **391**, 121–125
- 35 Yonemoto, W., McGlone, M. L., Grant, B. and Taylor, S. S. (1997) Autophosphorylation of the catalytic subunit of cAMP-dependent protein kinase in *Escherichia coli*. *Protein Eng.* **10**, 915–925
- 36 Herberg, F. W. and Taylor, S. S. (1993) Physiological inhibitors of the catalytic subunit of cAMP-dependent protein kinase: effect of MgATP on protein-protein interactions. *Biochemistry* **32**, 14015–14022
- 37 Glass, D. B., Cheng, H. C., Mende Mueller, L., Reed, J. and Walsh, D. A. (1989) Primary structural determinants essential for potent inhibition of cAMP-dependent protein kinase by inhibitory peptides corresponding to the active portion of the heat-stable inhibitor protein. *J. Biol. Chem.* **264**, 8802–8810
- 38 Cadd, G. and McKnight, G. S. (1989) Distinct patterns of cAMP-dependent protein kinase gene expression in mouse brain. *Neuron* **3**, 71–79
- 39 Murtaugh, M. P., Steiner, A. L. and Davies, P. J. (1982) Localization of the catalytic subunit of cyclic AMP-dependent protein kinase in cultured cells using a specific antibody. *J. Cell Biol.* **95**, 64–72
- 40 Howard, P., Day, K. H., Kim, K. E., Richardson, J., Thomas, J., Abraham, I., Fleischmann, R. D., Gottesman, M. M. and Maurer, R. A. (1991) Decreased catalytic subunit mRNA levels and altered catalytic subunit mRNA structure in a cAMP-resistant Chinese hamster ovary cell line. *J. Biol. Chem.* **266**, 10189–10195
- 41 Singh, T. J., Roth, C., Gottesman, M. M. and Pastan, I. H. (1981) Characterization of cyclic AMP-resistant Chinese hamster ovary cell mutants lacking type I protein kinase. *J. Biol. Chem.* **256**, 926–932
- 42 Kinzel, V. and Kubler, D. (1976) Single step purification of the catalytic subunit(s) of cyclic 3',5'-adenosine monophosphate-dependent protein kinase(s) from rat muscle. *Biochem. Biophys. Res. Commun.* **71**, 257–264
- 43 Cauthron, R. D., Carter, K. B., Liauw, S. and Steinberg, R. A. (1998) Physiological phosphorylation of protein kinase A at Thr-197 is by a protein kinase A kinase. *Mol. Cell. Biol.* **18**, 1416–1423
- 44 Cheng, X., Ma, Y., Moore, M., Hemmings, B. A. and Taylor, S. S. (1998) Phosphorylation and activation of cAMP-dependent protein kinase by phosphoinositide-dependent protein kinase. *Proc. Natl. Acad. Sci. U.S.A.* **95**, 9849–9854
- 45 Gibbs, C. S., Knighton, D. R., Sowadski, J. M., Taylor, S. S. and Zoller, M. J. (1992) Systematic mutational analysis of cAMP-dependent protein kinase identifies unregulated catalytic subunits and defines regions important for the recognition of the regulatory subunit. *J. Biol. Chem.* **267**, 4806–4814
- 46 Nigg, E. A., Hilz, H., Eppenberger, H. M. and Dutly, F. (1985) Rapid and reversible translocation of the catalytic subunit of cAMP-dependent protein kinase type II from the Golgi complex to the nucleus. *EMBO J.* **4**, 2801–2806
- 47 Harootunian, A. T., Adams, S. R., Wen, W., Meinkoth, J. L., Taylor, S. S. and Tsien, R. Y. (1993) Movement of the free catalytic subunit of cAMP-dependent protein kinase into and out of the nucleus can be explained by diffusion. *Mol. Biol. Cell* **4**, 993–1002
- 48 Tsugawa, M., Asakawa, H., Miyagawa, J., Katsura, H., Komatsu, R., Iida, S., Fujii, H., Gomi, M., Moriwaki, K. and Tarui, S. (1990) Rounding of cultured human carcinoma tumor cells by forskolin. *Anticancer Res.* **10**, 63–66
- 49 Han, J. D. and Rubin, C. S. (1996) Regulation of cytoskeleton organization and paxillin dephosphorylation by cAMP. Studies on murine Y1 adrenal cells. *J. Biol. Chem.* **271**, 29211–29215
- 50 Roger, P. P., Rickaert, F., Huez, G., Authelat, M., Hofmann, F. and Dumont, J. E. (1988) Microinjection of catalytic subunit of cyclic AMP-dependent protein kinase triggers acute morphological changes in thyroid epithelial cells. *FEBS Lett.* **232**, 409–413

Received 4 January 2000/4 July 2000; accepted 20 July 2000