

# Polarization of Fluorescently Labeled Myosin Subfragment-1 Fully or Partially Decorating Muscle Fibers and Myofibrils

Oleg A. Andreev, Albina L. Andreeva, and Julian Borejdo

Baylor Research Institute, Baylor University Medical Center, Dallas, Texas 75226 USA

**ABSTRACT** Fluorescently labeled myosin heads (S1) were added to muscle fibers and myofibrils at various concentrations. The orientation of the absorption dipole of the dye with respect to the axis of F-actin was calculated from polarization of fluorescence which was measured by a novel method from video images of muscle. In this method light emitted from muscle was split by a birefringent crystal into two nonoverlapping images: the first image was created with light polarized in the direction parallel to muscle axis, and the second image was created with light polarized in the direction perpendicular to muscle axis. Images were recorded by high-sensitivity video camera and polarization was calculated from the relative intensity of both images. The method allows measurement of the fluorescence polarization from single myofibril irrigated with low concentrations of S1 labeled with dye. Orientation was also measured by fluorescence-detected linear dichroism. The orientation was different when muscle was irrigated with high concentration of S1 (molar ratio S1:actin in the I bands equal to 1) then when it was irrigated with low concentration of S1 (molar ratio S1:actin in the I bands equal to 0.32). The results support our earlier proposal that S1 could form two different rigor complexes with F-actin depending on the molar ratio of S1:actin.

## INTRODUCTION

Muscle contraction is caused by ATP-driven cyclic interaction of myosin heads (subfragment-1, S1) and actin filaments. It is believed that force is generated when attached myosin heads execute "power stroke" during which they change orientation with respect to actin filaments (Huxley, 1969). It has been suggested that change of orientation is associated with modification of contact area between S1 and actin (Huxley and Simmons, 1971; reviewed by Huxley and Kress, 1985).

The support for this model has been provided by experiments which investigated the effect of the ratio of S1:actin on tryptic digestions and cross-linking of acto-S1 complexes. These experiments showed that the interface between S1 and actin was dependent of the molar ratio (Mornet et al., 1981a, 1981b; Yamamoto and Sekine, 1986; Huang et al., 1990). We proposed that when F-actin was partially decorated by S1, heads bound through it with a different conformation than when it was fully saturated with S1 (Andreev and Borejdo, 1992). Unfortunately, this idea could not be checked directly by electron microscopy, because partially decorated actin filaments are not amenable to three-dimensional reconstruction. But it is possible to detect different conformations by probe methods: the fluorescence polarization and EPR probe methods have been widely used to study orientation of labeled myosin in muscle fibers and of labeled S1 added to fibers (Dos Remedios et al., 1972; Tregear and Mendelson,

1975; Thomas and Cooke, 1980; Borejdo et al., 1982; Burghardt et al., 1983; reviewed by Cooke, 1986; Thomas, 1987). However, in all experiments in which exogenous S1 was added to fibers, in order to obtain a high fluorescence signal, a high concentration of S1 was added (the only exception we are aware of is a paper by Tregear and Mendelson (1975), who may have not fully saturated actin, see Discussion). In this paper we measured, by polarization of fluorescence and fluorescence-detected linear dichroism, the orientation of fluorescently labeled S1 that was partially or fully decorating thin filaments in glycerinated muscle fibers and in single myofibrils. To be able to measure orientation in single myofibrils, we developed a novel method where polarization was measured from video images. To achieve the conditions where filaments were fully decorated with S1, we irrigated muscle with high micromolar concentration of fluorescently labeled S1. To achieve the conditions where filaments were partially decorated with S1, we irrigated muscle with a nanomolar concentration of S1. We measured significant differences in the polarization of fluorescence and linear dichroism of both complexes and concluded that the orientation of S1 with respect to F-actin depended on the molar ratio.

## MATERIALS AND METHODS

### Measurements of polarization of fluorescence and linear dichroism

Fluorescence-detected linear dichroism (FDLD) of muscle fibers was measured as described before (Borejdo et al., 1982). Polarization of fluorescence was measured in the same apparatus as linear dichroism, but an analyzer, in either parallel or perpendicular orientation with respect to the fiber axis was inserted before a photomultiplier tube. For each orientation of the polarizer, two orthogonal emission polarizations were measured. The background was measured in the vicinity of each preparation.

Polarization of fluorescence of individual myofibrils gives a more accurate estimate of orientational angle than polarization of fluorescence of

Received for publication 8 September 1992 and in final form 16 June 1993.

Address reprint requests to J. Borejdo at Baylor Research Institute, Baylor University Medical Center, 3812 Elm St., Dallas, TX 75226.

**Abbreviations used:** S1, myosin subfragment 1; FDLD, fluorescence-detected linear dichroism; MR, molar ratio S1/actin; IATR, iodoacetamidotetramethylrhodamine; 1,5-IAEDANS, 5-[2-[(iodoacetyl)amino]ethyl]-aminonaphthalene-1-sulfonic acid; AOI, area of interest.

© 1993 by the Biophysical Society

0006-3495/93/09/1027/12 \$2.00

muscle fibers (see Discussion for reasons). However, the photometric method could not be applied to myofibril irrigated with low concentration of S1 because the contribution of background was too large: the ratio of the fluorescent signal emitted from myofibril,  $F_{\text{myof}}$ , to noise emitted from the background,  $F_{\text{bck}}$  is

$$\frac{F_{\text{myof}}}{F_{\text{bck}}} = \frac{\iint I_{\text{myof}}(x, y) dx dy}{\iint I_{\text{bck}}(x, y) dx dy} = \frac{(A I_{\text{myof}}) S_{\text{myof}}}{(A I_{\text{bck}}) S_{\text{tot}}} \quad (1)$$

where  $A I_{\text{myof}}$  and  $S_{\text{myof}}$  are the average intensity of light emitted by myofibril and an area occupied by myofibrils, respectively.  $A I_{\text{bck}}$  and  $S_{\text{tot}}$  are the average intensity of light emitted by the background and a total area of a slit image from which the intensity is recorded, respectively. Of course  $S_{\text{tot}} > S_{\text{myof}}$ . The best signal-to-noise ratio is obtained when  $S_{\text{myof}}$  is as close to  $S_{\text{tot}}$  as possible. Using the photometric method it is impossible to approach this condition, because with small concentration of S1 there is not enough light emitted by myofibril to see the slit image. However, the video method avoids this difficulty because the image of a myofibril can be zoomed and the area from which the measurement is taken can be selected to be smaller than the area occupied by a myofibril, i.e.,  $S_{\text{myof}} = S_{\text{tot}}$ .

## Imaging myofibrils

In the video method, the fluorescent light is split by a birefringent crystal into two parts: one created with fluorescent light that was polarized vertically and one horizontally. We measured polarization of fluorescence of myofibrils from the relative intensities of the two images and calculated the orientation of S1 from the value of the polarization. The video microscope system used to image samples and to measure their polarization of fluorescence is shown in Fig. 1: A mercury vapor lamp was used to generate a beam of light. A 520-nm bandpass excitation filter was mounted before the sample. The beam of light was attenuated by neutral density filters (ND). The direction of polarization was defined by a Glan-Taylor polarizer (PR). The beam was next passed through an adjustable-width slit which was mounted in the place of the excitation field diaphragm (FD<sub>1</sub>). The purpose of the slit was to ensure that the backgrounds of the two orthogonal images of a myofibril did not overlap and thus that the intensity of the background could be reliably subtracted from the intensity of each orthogonal component. A dichroic mirror (DM) directed all wavelengths below 580 nm at sample (S) which was placed on the stage of a Zeiss Photomicroscope III. The fluorescent light was collected through a  $\times 100$  Neofluar (numerical aperture (N.A.) = 1.3) objective, then passed through a barrier filter into a

circular emission field diaphragm (FD<sub>2</sub>). A critical component of the system was a calcite birefringent crystal (BC, calcite beam-displacing prism) which was mounted above FD<sub>2</sub> by inserting it in Zeiss 977901 video extension tube. It created two nonoverlapping images of a sample separated vertically by 120 pixels. The top image was created with the emitted light which was polarized horizontally, and the bottom one was created with the emitted light which was polarized vertically. Since both the images were created with parallel beams of light, no relay lens or mirrors were necessary to form an image of the myofibrils on a faceplate of a SIT camera (Model SIT-68; Dage-MTI, Michigan City, IN). This is a more convenient arrangement than the one originally used by Kinosita et al. (1991) which included a Wollaston prism and mirrors to make emitted light beams parallel. In our arrangement the angle between the incident and the emitted light beams was 360°. The video signal was recorded on a VCR (Sharp VC6610U; Mahwah, NJ) and later grabbed by a frame grabber (MV1; MetraByte Corp, Taunton, MA) operated by an AT-type computer. Fluorescence intensity of images was of course considerably smaller when myofibrils were irrigated with low in comparison with high concentration of S1. To keep the signal-to-noise ratio the same in both experiments, we adjusted the brightness by attenuating the mercury light with N.D. filters when myofibrils were irrigated with high concentrations of S1, rather than changing gain or high voltage settings on the camera.

## Measuring polarization of fluorescence from images

Images of myofibrils were transferred from the VCR tape to a computer by a frame grabber. The relative intensities of the two images carry the information about polarization properties of the sample. The intensities were analyzed by Image Pro Plus image analysis program (Media Cybernetics, Silver Spring, MD). Image Pro allows one to measure the average intensity with a better than 0.5% accuracy. Myofibrils were always oriented horizontally. Let the intensity of light emanating from an object of interest be indicated by " $I$ " and the intensity of light emanating from a background near an object be indicated by " $bck$ ." Let the direction of an excitation polarization be indicated by a subscript " $v$ " (for vertical or perpendicular to the axis of filaments) or " $h$ " (for horizontal or parallel to the axis of filaments) before a symbol  $I$  or  $bck$ . Let the direction of emission polarization be indicated by a subscript " $v$ " or " $h$ " after  $I$  or  $bck$ . Since the birefringent prism created two images of myofibrils, we measured two components of polarization of fluorescence for each of the two orientations of the excitation polarizer. When the excitation polarizer was vertical, the local intensity of a myofibril in an image which was created with vertically polarized emitted light was  $\sqrt{I_v}$ . The local intensity of the background near the point where sample measurement was taken was  $\sqrt{bck_v}$ . The intensity of the same segment of myofibril in an image which was created with horizontally polarized emitted light was  $\sqrt{I_h}$ . The intensity of the background was  $\sqrt{bck_h}$ . When the excitation polarizer was horizontal, the corresponding intensities were  $\sqrt{I_v}$ ,  $\sqrt{bck_v}$ ,  $\sqrt{I_h}$ , and  $\sqrt{bck_h}$ .

## Corrections for polarization of fluorescence

Systematic errors in measuring polarization of fluorescence arise because of the large numerical aperture of the objective, nonlinearities in imaging and because of the photobleaching. In addition, a major error is caused by the uneven detection of orthogonal polarization components due to the depolarization of light by the dichroic mirror.

The high numerical aperture of the objective causes depolarization of exciting and emitted light (Borejdo et al., 1982) and thus affects the absolute value of polarization of fluorescence. However, polarization was the same when N.A. of the objective was 0.75 and 1.3. Moreover, we were interested only in a relative change in polarization when muscle was irrigated with high and low concentrations of S1, and have therefore made no correction for this effect. For the video method, the error arises because of a nonlinear response of the SIT camera-video recorder combination. To estimate this error we measured the average intensities of light transmitted by different OD filters. The results are plotted in Fig. 2. As a figure of merit for the linear fit we

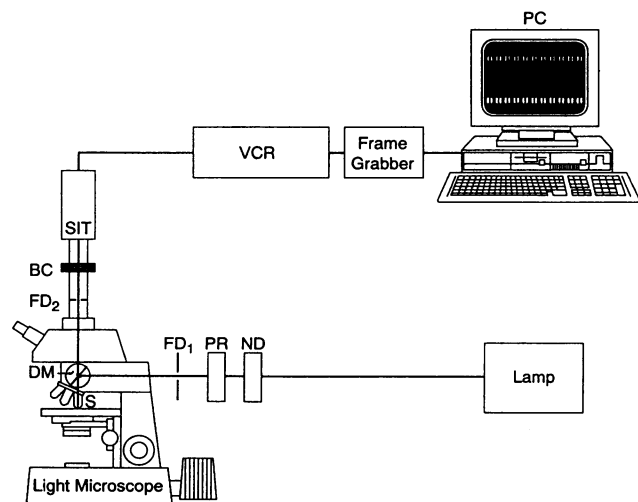

FIGURE 1 Schematic diagram of the apparatus. Abbreviations: ND, neutral density filters; PR, polarization rotator; S, sample; DM, dichroic mirror; FD<sub>1</sub> and FD<sub>2</sub>, field diaphragm; BC, birefringent crystal; SIT, SIT video camera; VCR, video cassette recorder; PC, personal computer.

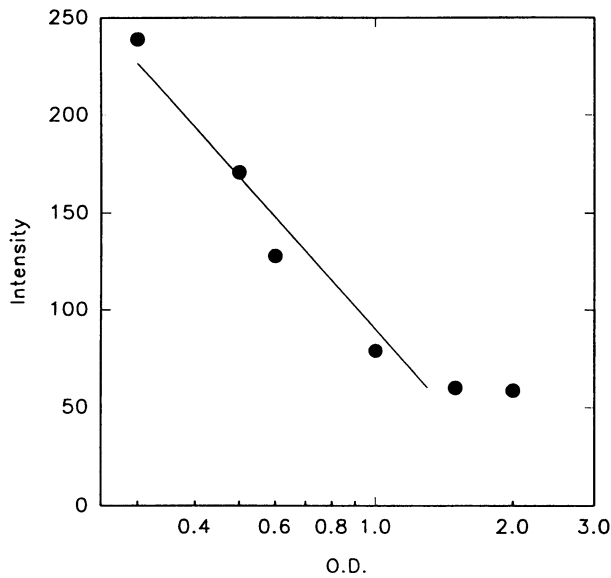

FIGURE 2 The linearity of SIT camera-VCR system. The vertical axis is in absolute units (0 = black, 255 = white).

used the normalized residual  $N$ :  $N$  = square root of the sum of squares of residuals of the Marquardt-Levenberg fit. For the data in Fig. 2,  $N = 0.57$ . This indicates a good fit. The dynamic response was limited by the saturation for all OD > 1.5, due to the high voltage at which SIT camera operated.

The muscle may photobleach differently when excited with horizontally and vertically polarized light. In fact, such orientational photobleaching has been exploited to measure rotational diffusion of acetylcholine receptors (Velez et al., 1990), DNA reorientation in nuclei (Selvin et al., 1990) and recently, rotational motion of cross-bridges in single muscle fibers (T. Burghardt, personal communication). However, since polarization of fluorescence is a ratio of the two intensity components obtained simultaneously, the effect should cancel out. Moreover, in our experiments photobleaching was minimal, because all solutions contained 1%  $\beta$ -mercaptoethanol and because the light intensity was low (incident intensity was typically 0.15 mW). The quantum yield for photobleaching, which was measured by following the decrease in emitted light intensity of native myosin in single muscle fibers labeled with IATR was smaller than  $10^{-5}$  (Borejdo et al., 1979).

The most significant error arises because the polarization of emitted light is changed by a dichroic mirror (Jenkins and White, 1957). To correct for this, the polarizations of a rhodamine dye and of S1 labeled with IATR in solution were measured under our microscope and in SLM 500C spectrofluorometer. For free rhodamine the spectrofluorometer gave  $P = 0.04$  and for rhodamine-labeled S1 it gave  $P = 0.41$ . The corrected values of  $P_v$  and  $P_h$  measured under microscope must be equal to  $P$  measured in conventional spectrofluorometer, i.e.,  $P_v = P_h = P$  (IATR-S1 and rhodamine molecules are not oriented in solution), where  $P$  is 0.04 for free rhodamine and 0.41 for IATR-S1. The correction factors  $C_v$  and  $C_h$  were 1.57 and 1.24 for  $P_v$  and  $P_h$ , respectively. These correction factors were used to calculate the polarization of fluorescence of myofibrils:

$$P_v = \frac{(vI_v) - C_v(vI_h)}{(vI_v) + C_v(vI_h)} \quad (2)$$

$$P_h = \frac{(hI_h) - C_h(hI_v)}{(hI_h) + C_h(hI_v)} \quad (3)$$

## Solutions

Fibers were glycerinated in a relaxing solution containing 80 mM potassium acetate, 2 mM  $MgSO_4$ , 2 mM ATP, 5 mM EGTA, 0.2 mg/ml phenylmethyl-

sulfonyl fluoride, 2 mM  $\beta$ -mercaptoethanol, 10 mM Tris-acetate, pH 7.5, and 50% glycerol. Rigor solution had the same composition except that ATP, EGTA, and glycerol were omitted and 1%  $\beta$ -mercaptoethanol was added. EDTA-rigor solution had the same composition as rigor solution, except 2 mM EDTA was added and  $MgSO_4$  was omitted. Modified Hasselbach-Schneider solution contained 0.6 M KCl, 4 mM  $MgCl_2$ , 10 mM potassium phosphate buffer, pH 6.4, 1 mM EGTA and 4 mM ATP.

## Proteins

Myosin was prepared from rabbit skeletal muscle by the method of Tonomura et al. (1966). S1 was obtained by a chymotryptic digestion of myosin according to Weeds and Taylor (1975). Actin was prepared according to Spudich and Watt (1971). The concentrations of proteins were measured by absorbance, using S1,  $A_{280}^{1\%} = 7.5$ ; G-actin,  $A_{290}^{1\%} = 6.3$ ; F-actin,  $A_{290}^{1\%} = 6.7$ . The concentration of labeled S1 was calculated by absorbance at 280 nm after subtracting absorbance of IATR at this wavelength ( $A_{280}(IATR) = 0.25 A_{555}(IATR)$ ). The quality of proteins was checked by SDS-PAGE and by the ability to produce motions in in vitro motility assay.

## Labeling of S1

S1 was labeled by incubating it with 1.5 molar excess of IATR or 1,5-IAEDANS for 6 h on ice. The absorption spectrum of IATR is shown in Fig. 3. The small size of the absorption shoulder at 530 nm and high absorption coefficient at 555 nm ( $68,000 M^{-1}$ ) suggests that the dye (Lot 11111 by Molecular Probes) is composed predominantly of 5' isomer of tetramethylrhodamine (Ajtai et al., 1992). To remove free and noncovalently bound dye, S1 was centrifuged at 500 rpm for 2 min in a column made by filling a 3-ml syringe with Sephadex G-50. A degree of labeling was typically 90%. This procedure labels specifically Cys-707 thiol (Borejdo et al., 1982). At 0.5 M KCl, 50 mM Tris-HCl, pH 7.5, and in the presence of 5 mM  $Ca^{2+}$ , the ATPase activity of 94% modified S1 was 1.35/s. At 0.5 M KCl, 50 mM Tris-HCl, pH 7.5, and in the presence of 5 mM EDTA, the ATPase activity of 94% modified S1 at high salt was 0.5/s. In 50 mM KCl, 2 mM  $MgCl_2$ , 10 mM Tris-acetate and 0.2 mM  $CaCl_2$ , the ATPase activity of 0.06  $\mu M$

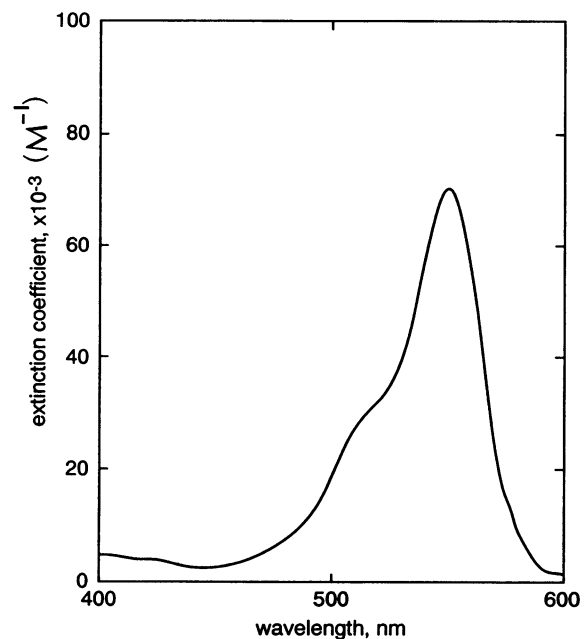

FIGURE 3 The excitation spectrum of lot 11111 of Molecular Probes IATR used in this work. 5  $\mu M$  IATR in 50 mM KCl, 10 mM potassium phosphate buffer, pH 7.0, 2 mM  $Mg_2Cl$ , room temperature.

modified S1 in the presence of 0.05 mg/ml myofibrils was 0.18/s/S1 which was only 1.61 times smaller than ATPase of unmodified S1. Under the same conditions the activity of native myofibrils was 0.37/s/myosin head.

## Preparation of muscle fibers and myofibrils

Bundle of fibers were first transferred from a relaxing glycerinating solution to a large volume of EDTA-rigor solution for 0.5 h to prevent contraction when [ATP] became small. Before experiments, the fibers were washed with rigor solution. Myofibrils were prepared from glycerinated muscle fibers. Fibers were homogenized on ice in an Omni Mixer (Waterbury, MA) at setting 8 for 30 s. They were then filtered through two layers of gauze and 0.1 mg/ml of phenylmethylsulfonyl fluoride was added to prevent proteolysis. The measurements were taken only from myofibrils which had sarcomere length in the range  $2.4 \pm 0.2 \mu\text{m}$ . Myofibrils were used within 1–2 days.

## SDS-PAGE

PAGE was run according to Laemmli (1970) in a buffer containing 25 mM Tris, 192 mM glycine, 0.1% SDS, in 12% polyacrylamide gels. The staining solution contained 50% methanol, 7.5% acetic acid, and 0.25% Coomassie Blue. The fixing and destaining solutions contained 50% ethanol and 7.5% acetic acid. After the electrophoresis and staining, the slab was dried using a Novex Gel Dryer Kit (Novex Co., San Diego, CA). The molar ratio of heavy chain of S1 to actin was measured as follows: the dried slab gel was placed on a flat bed scanner (ScanJet; Hewlett Packard, Palo Alto, CA), and the graphics image was obtained by a computer operating the Gray F/X program (Xerox Imaging, Peabody MA). Even though the scanner produced a reflectance image of the gel, a calibration (done using a stepped density filter, Edmund Scientific, Barrington, NJ) showed that the intensities of the bands were inversely proportional to their transmittance. The graphic files were printed out using PageMaker 4.00 (Aldus Co., Seattle, WA) on a Linotronix 300 typesetter. To calculate the molar ratio, the intensity within two parallel lines was measured by the Image Pro Plus program. The area under the peaks corresponding to a heavy chain of S1 and actin was measured by ANALYZE function of JAVA 1.4 image analysis program (Jandel Scientific, Corte Madera, CA). The molar ratio (MR) was calculated assuming the molecular weight of heavy chain of S1 as 95,000 and actin as 43,000.

## RESULTS

### Measuring the molar ratio of exogenous S1: myofibrillar actin

We compared images of myofibrils obtained after incubation with 2  $\mu\text{M}$  ("high") and 0.1  $\mu\text{M}$  ("low") concentration of fluorescent S1. Myofibrils ( $\sim 1 \text{ mg/ml}$ ) were incubated for 40 min at room temperature with S1. The molar ratio of S1 to myofibrillar actin was measured by sedimenting myofibrils at 1000 rpm for 5 min in IEC DPR-6000 centrifuge and performing SDS-PAGE of the precipitate. Fig. 4A is a typical Coomassie Blue pattern of the precipitate. Each lane was scanned and the area under the peaks corresponding to heavy chain of S1 and actin was measured by two methods: first, the peaks were weighed after subtracting the background by manually extrapolating the baseline of each peak. Second, a computer program ANALYZE was used. This program automatically corrects for the fact that the background levels of lanes were different by determining positions of the minima of the peaks and integrating between these minima. Because myofibrils alone had a major peak migrating close to 95-kDa band of S1, computer method was more accurate. Lane a is

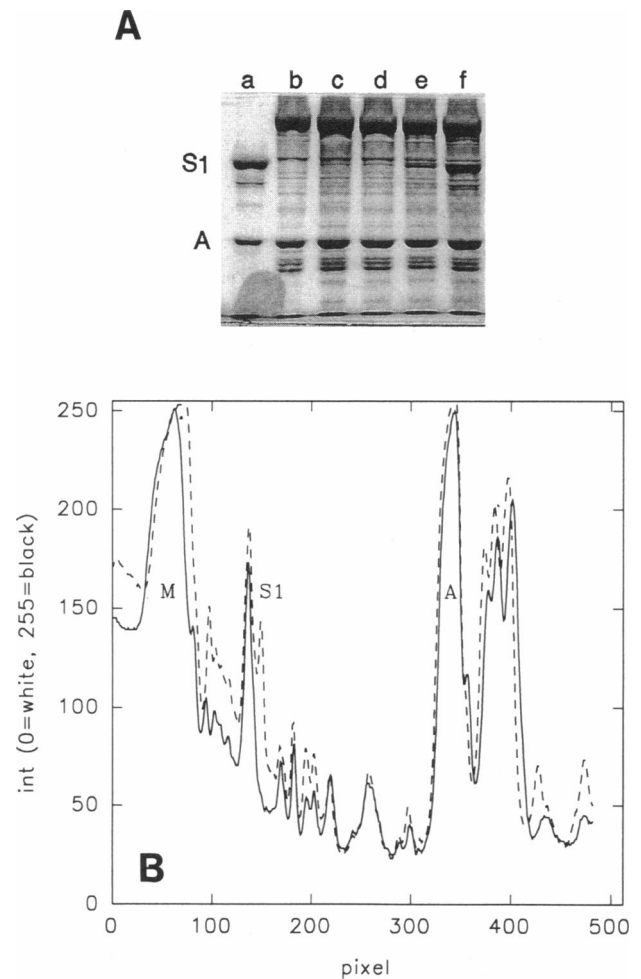

FIGURE 4 In A, SDS-PAGE pattern of myofibrils irrigated with increasing concentrations of S1. (a) S1 and actin at molar ratio of 1:1. (b–f) 1 mg/ml myofibrils were incubated with various concentrations of S1 for 40 min at room temperature, centrifuged at 1000 rpm for 5 min, and electrophoresed on SDS-PAGE. (b) Native myofibrils. (c) Myofibrils + 0.02  $\mu\text{M}$  S1. (d) Myofibrils + 0.1  $\mu\text{M}$  S1 (such preparations were used for experiments using "low" concentration of S1). (e) Myofibrils + 0.5  $\mu\text{M}$  S1. (f) Myofibrils + 2  $\mu\text{M}$  S1 (such preparations were used for experiments using "high" concentration of S1). In B, intensity profiles of myofibrils irrigated with 0.1  $\mu\text{M}$  S1 used to measure the molar ratio of S1:actin. The intensities have been reversed and 0 corresponds to white and 255 to black.

a pattern of 1:1 molar mixture of S1 and actin. The ratio of the area under the peaks corresponding to the heavy chain of S1 to the area corresponding to actin was 2.23 by weighing and 2.01 by computer program. Taking the ratio of the molecular weights of the heavy chain of S1 to actin as 2.21, we conclude that the error in estimating a molar ratio by measuring the intensity of Coomassie Blue-stained bands is less than 10%. In lane b, a pattern of the native myofibrils is shown as a solid curve in Fig. 4 B. Lane d (broken curve in Fig. 4 B) is a pattern obtained after incubating myofibrils with "low" concentration of S1. The molar ratio of heavy chain of S1 to actin determined by weighing the peaks after subtracting the background by eye was 0.08. ANALYZE program gave MR as 0.09. By repeating this procedure on lane

f, we obtained  $MR = 0.65$  by weighing and  $0.62$  by ANALYZE program.

In unextracted, unstretched sarcomere, only 27.5% of actin is in the I band (free of endogenous myosin). Since S1 at low concentration binds only to the I bands (Swartz et al., 1990), MR in the I bands was  $0.09/0.275 = 0.32$ . Thus actin was in 3 molar excess. To calculate the molar ratio after irrigation with high concentration of S1, we recognize that only 63% of all actins are available for binding by exogenous S1 (50% of actin in the overlap zone is occupied by endogenous myosin). We measured MR at  $0.62$ ; therefore S1 binds to every available actin, i.e., the stoichiometry of exogenous S1 to myofibrillar actin is 1:1.

### Polarization of fluorescence of fibers

A small bundle of fibers (0.2–0.5 mm in diameter) was placed on a microscope slide and incubated with  $0.1 \mu\text{M}$  of IATR-labeled S1 for 40 min at room temperature. After irrigation, fibers were extensively washed with rigor solution containing  $0.2 \text{ mM CaCl}_2$ . Fibers were placed horizontally under the microscope and measurements were done at room temperature using  $40\times$  (N.A. = 0.75) water immersion objective and Zeiss rhodamine dichroic cube (Zeiss filters: excitation, BP 546/12; dichroic mirror, FT 580; emission, LP 590). Data is summarized in Table 1 (row 1). The mean angle ( $\Theta_o$ ) between the dye dipoles and long axis of fiber and a standard deviation ( $\delta$ ) were calculated from a Gaussian model (see Discussion). After measurements were completed, the same fibers were incubated with  $2 \mu\text{M}$  fluorescently labeled S1 for 40 min at room temperature. Excess S1 was removed as before, and measurements were begun shortly after washing away excess S1 (within 5 min), to minimize the increase in background due to gradual dissociation of S1. Table 1 (row 2) summarizes these results. With better than 99% confidence, the difference in  $P_v$  for fibers irrigated with high and low concentrations of S1 labeled with IATR was statistically significant ( $t = -6.00$ ,  $P = 1.13 \times 10^{-7}$ ). The difference in  $P_h$  for S1 labeled with IATR was statistically significant with  $t = 4.51$  and  $P = 3.04 \times 10^{-5}$ .

The experiments were next repeated using S1 labeled with 1,5-IAEDANS. It was expected that the absolute values of polarization would be different, but that the difference in polarization between small and large concentration of S1 would be preserved. The procedure was identical to the one for IATR-labeled S1, except that UV excitation dichroic cube was used (heat filter, H365; excitation, BP 365/11; dichroic

mirror, FT 395; emission, LP 397). The data is summarized in Table 1 (rows 3 and 4). With better than 99% confidence, the difference in  $P_v$  for S1 labeled with 1,5-IAEDANS was statistically significant ( $t = 5.39$  and  $P = 1.63 \times 10^{-4}$ ). The difference in  $P_h$  was statistically significant with  $t = -6.95$  and  $P = 1.52 \times 10^{-5}$ .

### Linear dichroism of fibers

The experimental arrangement and procedures for measurement of dichroism were the same as for polarization, except that emission polarizer was removed and the excitation light was decreased  $10\times$ . Dichroic ratio  $R$  was defined as a ratio of intensity of fluorescence emitted when the fiber was illuminated with light polarized parallelly and perpendicularly to the long axis of muscle fiber. Data were corrected for the intrinsic dichroism of the instrument by measuring dichroism of free S1 in solution. Under these conditions the dichroic ratio must be 1, because the dipoles of fluorescent probes must be completely random. The data for linear dichroism of fibers irrigated with low or high IATR-S1 concentrations is summarized in rows 1 and 2 of Table 2. With better than 99% confidence, the difference in  $R$  was statistically significant ( $t = -4.6$  and  $P = 9.56 \times 10^{-5}$ ). The data for linear dichroism of fiber irrigated with low or high concentrations of 1,5-IAEDANS-labeled S1 is summarized in rows 3 and 4 of Table 2. Again, with high degree of confidence, the difference in  $R$  was statistically significant ( $t = 6.0$ ,  $P = 4.42 \times 10^{-5}$ ).

We next repeated the experiments using “ghost” fibers irrigated with IATR-labeled S1. Myosin was extracted from muscle fibers by 30-min incubation in modified Hasselbach-Schneider solution. After extraction muscle ghost was gently blotted and  $100 \mu\text{l}$  of  $0.1 \mu\text{M}$  solution of IATR-labeled S1 was placed on top of the fiber for 6 min, covering muscle completely. For irrigation with high concentration of S1, the procedure was the same as before, but  $[S1]$  was  $7.1 \mu\text{M}$  and irrigation was for 15 min. The fluorescence was excited with blue light (Zeiss filters in dichroic cube: excitation, BP 485/20; dichroic mirror, FT 510; emission, LP 520). Linear dichroism was measured at several (typically 5) points along fiber length, and the average was taken. At each position the measurements differed by less than 8%. The data is summarized in rows 5 and 6 of Table 2. With better than 99% confidence, the difference in  $R$  was statistically significant with  $t = 6.014$ .

**TABLE 1 Polarization of fluorescence of muscle fibers irrigated with low and high concentrations of S1 labeled with IATR or 1,5-IAEDANS**

	[S1] <sub>added</sub>	Dye	$P_v$	$P_h$	$\Theta_o$	$\delta$	$n$
1	$0.1 \mu\text{M}$	IATR	$0.608 \pm 0.011$	$0.044 \pm 0.016$	$65^\circ$	$25^\circ$	29
2	$2.0 \mu\text{M}$	IATR	$0.702 \pm 0.010$	$-0.063 \pm 0.016$	$71^\circ$	$26.5^\circ$	34
3	$0.1 \mu\text{M}$	IAEDANS	$0.297 \pm 0.032$	$0.310 \pm 0.014$	—†	—	7
4	$2.0 \mu\text{M}$	IAEDANS	$0.117 \pm 0.016$	$0.447 \pm 0.012$	—†	—	8

\* $n$ , number of measurements.

†Equations 4–7 are impossible to solve unequivocally, because the angle between absorption and emission dipoles of IAEDANS is not  $0^\circ$ .

**TABLE 2** Linear dichroism of muscle fibers irrigated with low and high concentrations of S1 labeled with IATR or 1,5-IAEDANS

	[S1] <sub>added</sub>	Dye	R*	Θ	n <sup>†</sup>
1	0.1 μM	IATR	0.504 ± 0.031	63.3°	13
2	2.0 μM	IATR	0.381 ± 0.109	66.4°	15
3	0.1 μM	IAEDANS	1.070 ± 0.031	53.8°	7
4	2.0 μM	IAEDANS	1.623 ± 0.047	47.9°	8
5 <sup>§</sup>	0.1 μM	IATR	0.678 ± 0.024	59.8°	10
6 <sup>§</sup>	7.1 μM	IATR	0.251 ± 0.010	70.5°	13

\*R, dichroic ratio-parallel intensity/perpendicular intensity ± SEM.

<sup>†</sup>n, number of measurements.

<sup>§</sup>5 and 6 were "ghost" fibers. The angle Θ was calculated as in Borejdo *et al.*, 1982.

### Polarization of fluorescence of myofibrils

Polarization of fluorescence was next measured from single myofibrils. Myosin was *not* extracted to keep the thin filaments intact and well aligned. The use of myofibrils eliminates errors due to nonhomogenous penetration of S1 to muscle fibers, trapping of S1 between the fibers, nonuniformities in sarcomere length within a fiber and to nonparallel arrangement of individual myofibrils within a fiber. The photometric method could not be applied to single myofibrils irrigated with small concentrations of S1, because background was sometimes equal to 40% of the signal. We therefore measured polarization of fluorescence of single myofibrils by video microscopy. This method allows measurement of the background only from the immediate vicinity of the myofibril (not from a whole field of view) and increases signal-to-noise ratio by at least an order of magnitude. Photometric and video methods gave similar results for myofibrils irrigated with high concentration of S1: in 24 experiments on four different myofibrillar preparations we obtained:  $P_v = 0.629 \pm 0.007$ ,  $P_h = -0.309 \pm 0.009$  using photometric method. This compares well with the values reported in Table 3 for polarizations of myofibrils irrigated with high [S1] measured by the video method.

Myofibrils were first incubated with 2 μM S1 for 40 min at room temperature. The sample was applied to a microscope slide, covered with a #1 coverslip and placed on a stage of a video microscope. Excess S1 was removed by thoroughly washing myofibrils with rigor solution by applying a drop of a solution to one side of a coverslip and sucking it with a filter paper on the other side. To measure the polarization of fluorescence, a myofibril that happened to be oriented horizontally was illuminated first with vertically polarized light (perpendicular to the axis of a myofibril), and its two orthogonally polarized fluorescent images were recorded on a VCR. The procedure was next repeated

**TABLE 3** Polarization of fluorescence of myofibrils irrigated by IATR-S1

	[S1] <sub>added</sub>	$P_v$	$P_h$	Θ <sub>o</sub>	δ	n*
1	2.0 μM	0.701 ± 0.026	-0.246 ± 0.036	71°	18.5°	21
2	0.1 μM	0.471 ± 0.020	-0.020 ± 0.023	60.5°	17.5°	39

\*n, number of myofibrils.

with the excitation light which was horizontally polarized (parallel to the axis). The measurements were done within 15 min after first washing unbound S1, to prevent it from dissociating from a myofibril and creating vacant spaces along F-actin, which could decrease molar ratio S1:actin (see Discussion). A typical myofibril illuminated with vertically polarized light is shown in the upper frame shown in Fig. 5. The bottom and the top images in this frame were created with the light which was polarized vertically and horizontally, respectively. It can be seen that the intensity of the fluorescence of the bottom image was significantly larger than the intensity of the top image, suggesting that  $P_v$  was large (see below). The same myofibril illuminated with horizontally polarized light is shown in the lower frame of Fig. 5. The ratio of the intensity of the top image of this frame to the intensity of the bottom image of this frame was smaller than the corresponding ratio in the upper frame, suggesting that  $P_h$  was small (see below).

Myofibrils were next studied under conditions of low saturation with S1. Myofibrils were incubated with 0.1 μM S1 for 40 min at room temperature. As shown in Fig. 4 B, the molar ratio of exogenous S1 to actin in I bands was 0.32, i.e.,

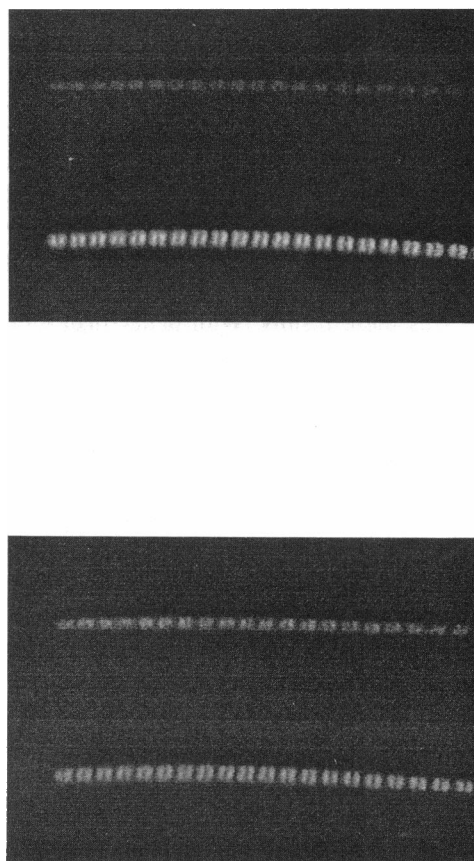

**FIGURE 5** Image of a myofibril irrigated with high concentration of IATR-S1 (2 μM). Upper frame: polarizer vertical, lower frame: polarizer horizontal. The top image in each frame was created with the fluorescent light polarized horizontally and the bottom image with light polarized vertically. The FD can not be seen because fluorescence was very intense. Magnification: 1125 ×.

the conditions were created where actin was in excess over S1. The sample was applied to a microscope slide, covered with a #1 coverslip and placed on a stage of a video microscope. The excess S1 was removed by thoroughly washing the myofibrils with a rigor solution. A typical myofibril illuminated with vertically polarized light is shown in the upper frame of Fig. 6. It can be seen that now the intensity of fluorescence in the bottom image was only a little larger than the intensity in the top image, suggesting that  $P_v$  was small. The same myofibril illuminated with horizontally polarized light is shown in the lower frame of Fig. 6. The intensity of the top image increased and the intensity of the bottom image decreased suggesting that  $P_h$  was now small.

To measure polarization of fluorescence, the image of a myofibril was enlarged (by applying a zoom), a rectangular AOI was placed inside a myofibril and its average intensity was measured. The AOI was then moved to a background near the myofibril and its intensity was measured. When the excitation polarizer was vertical, the total intensity of a myofibril and its background in the part of a frame which was created with vertically polarized emitted light was  $\sqrt{I_v}$  and  $\sqrt{bck_v}$ . The total intensity of the same myofibril and its background in a part of a frame which was created with horizontally polarized light was  $\sqrt{I_h}$  and  $\sqrt{bck_h}$ . When the excitation polarizer was horizontal the corresponding intensities were  ${}_hI_h$ ,  ${}_hbck_h$ ,  ${}_hI_v$ , and  ${}_hbck_v$ . The vertical (perpendicular to the myofibrillar axis) and horizontal (parallel to the myofibrillar axis) polarizations of fluorescence were calculated according to Eqs. 2 and 3.

The results of 21 experiments obtained from four myofibrillar preparations irrigated with high concentration of S1 are plotted in Fig. 7A. The data is plotted in histogram form, i.e., polarization is plotted versus the percentage of meas-

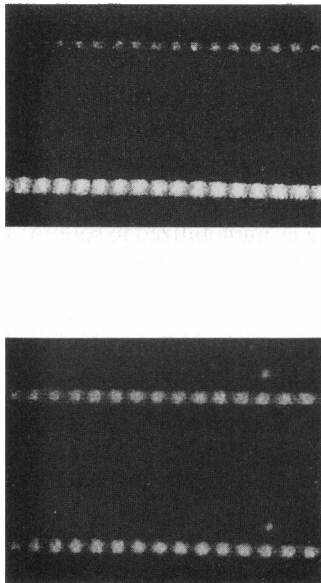

FIGURE 6 Image of a myofibril irrigated with low concentration (0.1  $\mu\text{M}$ ) of IATR-S1. Upper frame: polarizer vertical, lower frame: polarizer horizontal. Top and bottom images as in Fig. 5. Magnification: 1125  $\times$ .

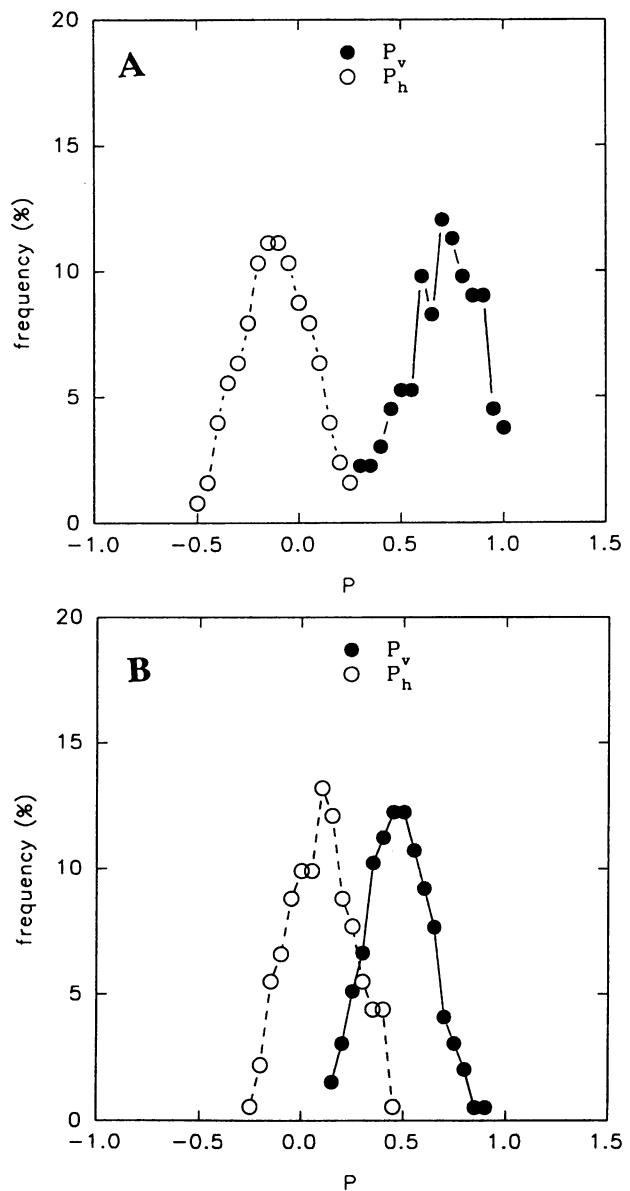

FIGURE 7 Fraction of the total number of measurements which gave particular value of polarization. (A) Myofibrils irrigated with high (2  $\mu\text{M}$ ) concentration of S1. (B) Myofibrils irrigated with low (0.1  $\mu\text{M}$ ) concentration of S1. To make the histogram look smooth, data points were running-averaged (window size = 7) and fitted with a spline function. Broken line:  $P_h$ , solid line:  $P_v$ .

urements which gave the particular value of polarization. It is seen that the absolute values of both polarizations are large, indicating good orientation of fluorophores. The results are summarized in Table 3 (row 1). The dipole of the dye formed an average angle of 71° with the long axis of myofibril (see Discussion).

The results of 39 experiments obtained from four myofibrillar preparations irrigated with low concentration of S1 are plotted in histogram form in Fig. 7B. The results are summarized in Table 3 (row 2). The dipole of the dye formed an average angle of 60.5° with the axis of a myofibril (see Discussion).

The difference in measured  $P_v$  and  $P_h$  when myofibrils were irrigated with low and high concentration of exogenous S1 was significant. The 0.230 difference in  $P_v$  was statistically significant with high probability ( $t = 6.78$ ,  $P = 1.88 \times 10^{-9}$ ). The 0.216 difference in  $P_h$  was also highly significant ( $t = -5.21$ ,  $P = 1.47 \times 10^{-6}$ ).

## DISCUSSION

We have measured anisotropy of fluorescence of S1 added to muscle at low and high concentrations by 6 different methods: 1) polarization of fluorescence of fibers irrigated with IATR-labeled S1, 2) dichroism of fibers irrigated with IATR-labeled S1, 3) polarization of fluorescence of fibers irrigated with 1,5-IAEDANS-labeled S1, 4) dichroism of fibers irrigated with 1,5-IAEDANS-labeled S1, 5) dichroism of ghost fibers irrigated with IATR-labeled S1, 6) polarization of fluorescence of myofibrils irrigated with IATR-labeled S1. In all six cases we saw statistically significant differences in polarization or dichroism when muscle was irrigated with low and high concentration of S1.

We think that the most accurate measurements are for single myofibrils. As mentioned before, the use of myofibrils eliminates errors due to nonhomogenous penetration of S1 to muscle fibers, depolarization due to trapping of S1 between the fibers, nonuniformities in sarcomere length within a fiber and errors due to nonparallel arrangement of individual myofibrils within a fiber. To measure the polarization of a single myofibril we used a novel method in which the intensity of polarized components is measured from video images of myofibrils. The video method gave the same result as the photometric method when the muscle was irrigated with high concentration of S1. However, in contrast to the photometric method, video method allows accurate measurements for low concentration of S1, because the signal-to-noise ratio is greater. Moreover, the video method of calculating  $P$  has the advantage that the intensities could be measured only in the areas where the quality of the image was judged to be good. For example, measurements were not made in the areas where a myofibril was not exactly horizontal or where S1 did not penetrate the I bands. A further advantage is that the spatial resolution of the method is very high. In fact, the intensity of an individual pixel ( $0.14 \times 0.14 \mu\text{m}$ ) could be measured. Such resolution is impossible when the intensity is measured by a photomultiplier. Polarization depends on the position within the sarcomere where the measurement is taken: In the presence of  $\text{Ca}^{2+}$ , at low concentration S1 attaches only to the I bands (Swartz et al., 1990). At high concentration, S1 attaches predominantly to the I bands but also (albeit to a lesser extent) to the overlap zone. Therefore polarization is greater in the I band than in the overlap zone. Our preliminary data indicates that polarization in the I band is by 14% greater than polarization of a whole myofibril. We did not examine this difference systematically, but in three experiments it was statistically significant. The next advantage of the method is that the measurements can be done

quickly (less than 5 s), because only the recording of images has to be done in real time (analysis can be done later). This is important in the present experiments, because the intensity of fluorescence decreases with time (by about 1% in 5 s). This indicates that, in addition to photobleaching, dissociation of S1 from thin filaments also occurs. Indeed, in two experiments after extensive washing (1 h) of fibers previously irrigated with high concentration of S1, the dichroic ratio increased from 0.25 to 0.50. Thus the molar ratio of S1 to actin progressively decreases. In addition, the ability to carry out recordings quickly minimizes orientational photobleaching, which arises because the quantum yield for photobleaching is different when the excitation polarizer is vertical and horizontal (see Materials and Methods). Next, the method takes advantage of the fact that for each orientation of the polarizer, both emission components are exact replicas of the same object (except for the polarization) thus eliminating errors due to the imperfect focus and to the uneven spatial distribution of exciting light. Finally, both images are recorded simultaneously eliminating errors due to fluctuations in the power of the mercury source. The primary disadvantage of the method is the limited dynamic response of the SIT camera: when polarization of fluorescence is high, one image may be so bright that it saturates the camera, while the other may be so weak that it cannot be seen. However, this problem can be avoided if an additional polarizer is inserted between birefringent crystal and camera to compensate for the difference in intensity of two images.

## Calculating the probe angle from polarization of fluorescence

In order to compute the angle  $\Theta$  between the absorption (or emission) dipole of the dye attached to S1 and the axis of F-actin, it is necessary to know the angle  $\lambda$  between the absorption and emission dipoles of rhodamine, the rigidity of the attachment of IATR to the  $\text{SH}_1$  group of S1 (characterized by an angle  $\alpha$  which is an average angle defining a cone within which the dye is able to rotate on the surface of S1), and the type of disorder of fluorophores. Angles  $\lambda$  and  $\alpha$  can be easily estimated: for rhodamine the angle  $\lambda$  must be close to  $0^\circ$  (excitation dipole parallel to emission dipole), because when IATR-S1 was immobilized in solution through binding to F-actin, its polarization of fluorescence ( $P = 0.45$ , at  $20^\circ\text{C}$ ) was close to the maximum theoretical polarization ( $P_{\text{max}} = 0.5$ ) of an assembly of immobile and random fluorophores. For the same reason  $\alpha$  must be close to  $0^\circ$ . Moreover, Borejdo et al. (1982) measured the wobbling of IATR on the surface of S1 and concluded that it was small.

The type of disorder is more difficult to estimate. A model must be proposed to show how the polarization of an ideal helical array of fluorophores is affected by the disorder. A simple model, in which a fraction of probe molecules describes a perfect helical arrays around F-actin and the remaining fraction is randomly oriented has been considered by Tregear and Mendelson (1975), Mendelson and Morales



(see Borejdo and Putnam, 1977), Borejdo et al. (1982) and by Wilson and Mendelson (1983). An alternative approach is to model the disorder as a Gaussian spread of the probe angle around the mean value  $\Theta_0$  with a standard deviation  $\delta$  (Thomas and Cooke, 1980; Wilson and Mendelson, 1983; Yanagida, 1981; Barnett et al., 1986). We present here the results of analysis of experimental data by the model with Gaussian type of disorder.

We consider the system where dye dipoles are oriented with respect to long axis of actin filaments at mean polar angle  $\Theta_0$  with standard deviation  $\delta$ . The probability for dipole orientation at any angle is given by Gaussian function  $\rho(\Theta) = \exp[-(\Theta - \Theta_0)^2/2\delta^2]$ . The polarizations  $P_v$  and  $P_h$  are expressed as functions of the averages of  $\sin^2$  and  $\sin^4$ , which we shall refer  $S_2$  and  $S_4$ , respectively. The functions  $P_v$ ,  $P_h$ ,  $S_2$ , and  $S_4$  are

$$P_v = \frac{7S_4 - 4S_2}{4S_2 - S_4} \quad (4)$$

$$P_h = \frac{2 - 5S_2 + 3S_4}{2 - 3S_2 + S_4} \quad (5)$$

$$S_2 = \frac{\int_0^\pi \rho(\Theta) \sin^3 \Theta d\Theta}{\int_0^\pi \rho(\Theta) \sin \Theta d\Theta} \quad (6)$$

$$S_4 = \frac{\int_0^\pi \rho(\Theta) \sin^5 \Theta d\Theta}{\int_0^\pi \rho(\Theta) \sin \Theta d\Theta} \quad (7)$$

In the general case when absorption and emission dipoles are not parallel, the equations for  $P_v$  and  $P_h$  are more complicated (Wilson and Mendelson, 1983). However, as argued above, for IATR bound to S1 the angle between absorption and emission dipoles is approximately  $0^\circ$ . The values  $S_2$  and  $S_4$  can be found from Eqs. 4 and 5. The values  $\Theta_0$  and standard deviation  $\delta$  can be obtained from numerical solutions of Eqs. 6 and 7. The fit of the experimental data from muscle fibers to the Gaussian model is shown in Fig. 8A, and the fit of the experimental data from myofibrils in Fig. 8B. The values  $\Theta_0$  and  $\delta$  calculated for each set of experimental values  $P_v$  and  $P_h$  are presented in Tables 1 and 3.

The difference in polar angle of dye molecules of bound IATR-S1 in fully and partially saturated actin filaments was  $6^\circ$  for fibers and  $10.5^\circ$  for single myofibrils. The disorder was slightly lower at low than at high S1 concentrations. As expected, disorder was larger when muscle fibers rather than myofibrils were irrigated with S1. The polar angle  $\Theta_0$  was the same for myofibrils and fibers at high S1 concentration, while at low S1 concentration it was larger for fibers than for myofibrils. This might be due to difficulty for S1 at low concentration to penetrate to the center of muscle fibers. The diffusion of S1 inside of muscle is restricted by interaction with actin filaments and probably even 40-min incubation is not enough to reach uniform distribution of S1 inside muscle fiber. The actual concentration of S1 might be higher near the surface of muscle than in the center. The emitted light was usually collected from the surface of muscle fibers where the

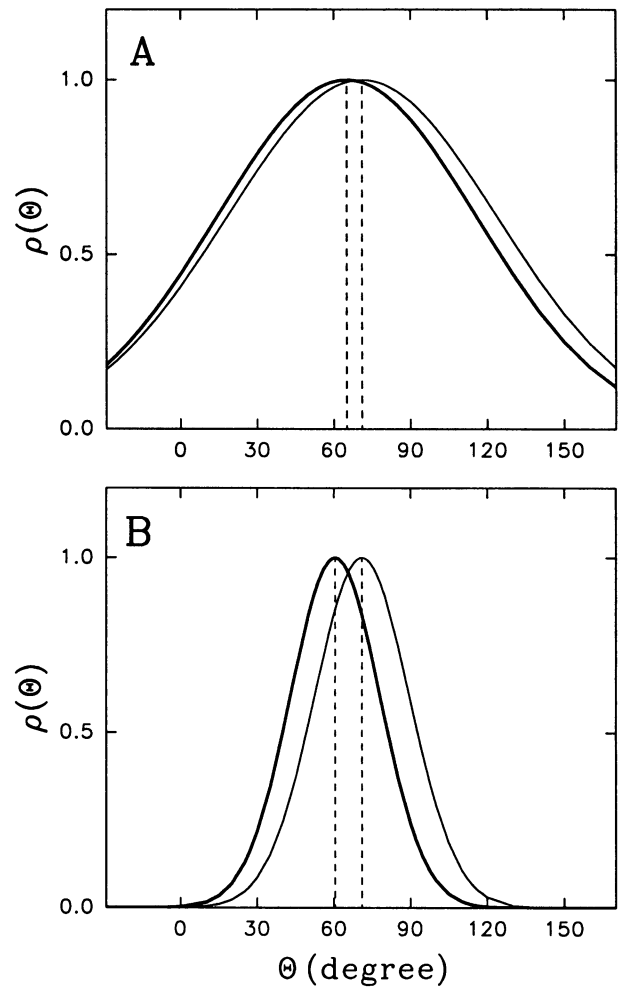

FIGURE 8 The angular distributions of dipoles of IATR covalently bound to S1 when muscle fibers (A) or myofibrils (B) were irrigated with IATR-S1 at low (bold line) and at high (thin line) concentrations. The vertical broken lines indicate the mean values ( $\Theta_0$ ) of corresponding distributions.

condition  $S1 \ll$  actin free sites may not be fulfilled and the second type of rigor complexes may not be a predominant one. When muscle fibers is irrigated by high S1 concentration the distribution of S1 might be nearly uniform because there are enough S1 molecules to occupy all available sites on actin filaments. In the case of myofibrils, the problem of nonuniform distribution does not arise, because the size of a myofibril is significantly smaller than that of muscle fiber. This is a principal advantage of measuring orientation of S1 in a myofibril rather than in muscle fibers.

On the basis of these findings we propose that S1 is able to bind to F-actin with two different orientations: one is predominant at high S1 concentration and another at low S1 concentration. Actually, it is difficult to prepare a sample where just one type of acto-S1 complexes is present. It is likely that in both cases presented here (high and low S1 concentrations) there is a mixture of both types of acto-S1 complexes. For this reason the actual orientational difference between two populations of bound S1 might be larger, while a standard deviation  $\delta$  for each population could be smaller.

### A contribution of dissociated and nonspecifically bound heads

The dissociated heads may effect on total fluorescence polarization if their fraction is high. For instance, if  $[S1_{\text{free}}] \gg [S1_{\text{bound}}]$  than  $P_v \approx P_h \approx P(S1_{\text{free}}) \approx 0.41$ . The fraction of free S1 can be estimated as follows:  $S1_{\text{free}}/S1_{\text{bound}} = K_d/A_{\text{free}}$  where  $A_{\text{free}}$  is a concentration of free actin and  $K_d$  is a dissociation constant. It is obvious that  $A_{\text{free}}$  is bigger at low [S1] so the ratio  $S1_{\text{free}}/S1_{\text{bound}}$  must be smaller at low [S1], i.e., the contribution from dissociated heads is larger at high [S1] than at low [S1]. This suggestion is in agreement with the fact that the disorder ( $\delta$ ) was slightly bigger at high [S1] than at low [S1] (see Fig. 8 B and Table 3). But even at high [S1] the fraction of free S1 is small: this is because most of unbound S1 was washed out before each experiment and because at high [S1]  $P_h$  was negative and  $P_v$  was large and positive indicating high degree of orientation of S1.

We next considered a possibility that the observed difference was due to nonspecific binding at low molar ratios, i.e., to binding to protein other than actin. The contribution of nonspecific binding would be significant if it was stronger than actin-S1 binding. However, there are no reports that S1 could bind to other protein stronger than to F-actin under rigor conditions. Furthermore, we assessed a contribution of nonspecific binding of S1 to a myofibril experimentally. It is supposed that nonspecific binding should not be dependent on ATP. After adding relaxing solution to myofibrils irrigated at low [S1], the fluorescence image quickly and completely disappeared. This is illustrated in Fig. 9. Concentration of IATR-S1 was  $0.1 \mu\text{M}$ . In A a myofibril is in rigor solution. B, C, and D are images of the same myofibril 2, 5, and 30 min after adding 5 mM ATP + 4 mM EGTA. It is seen that 5 min after adding relaxing solution little fluorescence above background can remain (even though camera sensitivity was increased). The binding of S1 to myofibrils was ATP-dependent at low as well as at high concentrations of S1.

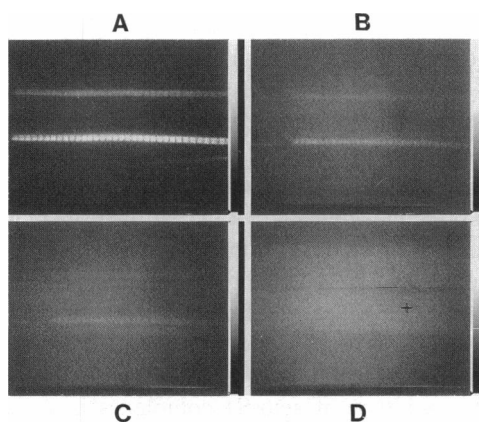

FIGURE 9 The effect of addition of ATP and EGTA on fluorescent image of a myofibril. (A) Image of a myofibril irrigated with low concentration ( $0.1 \mu\text{M}$ ) of IATR-S1, exciting polarization vertical, rigor solution. B, 2 min after adding 5 mM ATP and 4 mM EGTA; C, 5 min after; D, 30 min after. The sensitivity of a camera was increased from A to D.

Moreover, Swartz et al. (1990) showed that binding of S1 in myofibrils was specific and  $\text{Ca}^{2+}$ -dependent, specially at low concentration of added S1. We confirmed this observation (data not shown). When no S1 was added, or S1 that had not been fluorescently labeled was added even at very high concentrations ( $>10 \mu\text{M}$ ), no image of myofibrils at all was seen. There was no difference between the intensity at the point where the myofibril was located (verified by phase contrast) and the intensity of the background (this excellent separation between excited and emitted light and rejection of scattered light is due to careful design of the dichroic filter assembly in Zeiss Photomicroscope III).

### Comparison with earlier work

As far as we know, polarizations have not been previously measured for muscle irrigated with submicromolar concentration of S1. Tregear and Mendelson (1975) measured the polarization of muscle fibers irrigated with 1 and  $5 \mu\text{M}$  of 1,5-IAEDANS-labeled S1 and saw significant difference between the two in the same sense as reported here, i.e., the absolute values of polarizations were bigger for larger [S1]. It is possible that in their work actin was not saturated even after incubation with  $1 \mu\text{M}$  S1 since irrigation was carried out at  $0^\circ\text{C}$  on muscle fibers. Polarization values reported here for fibers irrigated with high concentration of 1,5-IAEDANS-labeled S1 (Table 1, row 4) are in good agreement with values obtained by Tregear and Mendelson (1975), Borejdo and Putnam (1977), and Ajtai and Burghardt (1987). The absolute polarization values reported here are smaller than those of Wilson and Mendelson (1983), perhaps because the excitation wavelength and angle of observation were different and because their data was corrected for the rotations of IAEDANS molecules with respect to S1. To our knowledge no measurements of polarization for fibers irrigated with IATR-labeled S1 has been reported. The measurements done by Ajtai and Burghardt (1986) and Ajtai et al. (1992) on fibers in which intrinsic myosin was labeled with IATR gave  $P_v \approx P_h \approx 0.3$ , determined from dichroic ratio of high concentration of IATR-labeled S1 (Table 2, row 2) is smaller than previously reported (Borejdo et al., 1982) and by 10% larger than measured by Szczesna and Lehrer (1992) for single myofibrils. The difference may be due to the fact that intensive washing of muscle by rigor solution can decrease the amount of bound S1 and so change the dichroism or polarization of fluorescence.

ATP- and calcium-dependent angular changes have been seen previously in muscle by both fluorescence polarization (Borejdo et al., 1979), by phosphorescence anisotropy decay (Stein et al., 1990), and by EPR (Cooke, 1986). However, only recently has it been shown that the myosin head rotations arise from heads attached to actin (Berger et al., 1990; Berger and Thomas, 1993). Nevertheless, there is no clear evidence for a *distinct* myosin head orientation in muscle other than the rigor angle (Thomas, 1993).

The possibility that the observed changes in orientation originated in actin cannot be excluded, because S1 is known to affect rotation of actin monomers in filaments (Thomas et al., 1979) and change conformation of filaments during different physiological states of muscle (Prochniewicz-Nakayama et al., 1983). However, the binding of S1 to actin does not change the orientation of a spin label bound to actin (Ostap et al., 1992). In addition, certain parameters related to binding of myosin fragments, such as flexibility, were affected only by double-headed heavy meromyosin (HMM) (and not by single-headed S1, e.g., Oosawa et al. (1973)).

The obtained results corroborate with earlier findings of several laboratories of nonlinear relation between changes of different parameters and the amount of bound myosin heads. Thus Tawada (1969) observed biphasic change of birefringence of F-actin oriented in flow at different degree of saturation by HMM. Changes of anisotropy and intensity of fluorescence of  $\epsilon$ -ADP incorporated in F-actin instead of ADP showed similar dependence on concentration of bound HMM (Miki et al., 1976). Thomas et al. (1979) showed that both S1 and HMM affect actin flexibility maximally at very low ratios of heads to actin. All these results suggested that conformation of rigor complexes were different at molar ratio of bound myosin heads to actin below 1:3 than at higher molar ratios.

## CONCLUSIONS

The main result of this paper is that the orientation of S1 with respect to actin filament depended on the molar ratio of exogenous S1 to myofibrillar actin. When this ratio was high, S1 bound with the IATR dipole largely perpendicular to the myofibrillar axis. When the ratio was low, S1 bound with the IATR dipole more parallel to the myofibrillar axis. At full saturation of F-actin by S1 the neighboring S1 molecules may make contact to each other and therefore the orientation and the conformation of S1 could be different from that in partially saturated F-actin. Moreover, our previous results demonstrated that in partially saturated F-actin the S1 molecule can bind to two actin monomers, while in fully saturated F-actin it binds just to a single actin, because the binding to a second actin was sterically blocked by a neighboring S1 (Andreev and Borejdo, 1991, 1992). We propose that the conformation of S1 characterized by polarization of fluorescence associated with irrigation with high concentration of S1 corresponds to a complex in which S1 binds to one actin monomer in a filament (A\*S1) and that the conformation characterized by polarization of fluorescence associated with irrigation with low concentration of S1 corresponds to a complex in which S1 binds to two actin monomers in a filament (A\*S1\*A). We speculate that the two types of complexes with different orientations might have a relation to the intermediate states of acto-S1 during hydrolysis of ATP.

We thank S. Burlacu for expert technical assistance, and R. Takashi for helpful discussions. Supported by National Institutes of Health grant AR40095-03.

## REFERENCES

- Ajtai, K., and T. P. Burghardt. 1986. Observation of two orientations from rigor cross-bridges in glycerinated muscle fibers. *Biochemistry*. 25:6203–6207.
- Ajtai, K., and T. P. Burghardt. 1987. Probe studies of the MgADP state of muscle cross-bridges: microscopic and wavelength-dependent fluorescence polarization from 1,5-IAEDANS-labeled myosin subfragment 1 decorating muscle fibers. *Biochemistry*. 26:4517–4523.
- Ajtai, K., A. Ringler, D. Toft, E. H. Hellen, P. J. Ilich, and T. P. Burghardt. 1992. Stereospecific reaction of muscle fiber proteins with the 5' or 6' iodoacetamide derivative of tetramethylrhodamine: only the 6' isomer is mobile on the surface of S1. *Biophys. J.* 61:287a. (Abstr.)
- Andreev, O. A., and J. Borejdo. 1991. The myosin head can bind two actin monomers. *Biochem. Biophys. Res. Commun.* 177:350–356.
- Andreev, O. A., and J. Borejdo. 1992. Two different acto-S1 complexes. *J. Muscle Res. Cell Motil.* 13:523–533.
- Barnett, V. A., P. Fajer, C. F. Polnaszek, and D. D. Thomas, D. D. 1986. High-resolution detection of muscle crossbridge orientation by electron paramagnetic resonance. *Biophys. J.* 49:144–146.
- Berger, C. L., and D. D. Thomas. 1993. Rotational dynamics of actin-bound myosin heads in active myofibrils. *Biochemistry*. 32:3812–3821.
- Berger, C. L., E. C. Svensson, and D. D. Thomas. 1990. Photolysis of photolabile precursor of ATP (caged ATP) induced microsecond rotational motion of heads bound to actin. *Proc. Natl. Acad. Sci. USA.* 86:8753–8757.
- Borejdo, J., and S. Putnam. 1977. Polarization of fluorescence from single skinned glycerinated rabbit psoas fibers in rigor and relaxation. *Biochim. Biophys. Acta.* 459:578–595.
- Borejdo, J., S. Putnam, S., and M. F. Morales. 1979. Fluctuations in polarized fluorescence: evidence that muscle cross-bridges rotate repetitively during contraction. *Proc. Natl. Acad. Sci. USA.* 76:6345–6350.
- Borejdo, J., O. Assulin, T. Ando, and S. Putnam. 1982. Cross-bridge orientation in skeletal muscle measured by linear dichroism of an extrinsic chromophore. *J. Mol. Biol.* 158:391–414.
- Burghardt, T. P., T. Ando, and J. Borejdo. 1983. Evidence for cross-bridge order in contraction of glycerinated skeletal muscle. *Proc. Natl. Acad. Sci. USA.* 80:7515–7519.
- Cooke, R. 1986. The mechanism of muscle contraction. *CRC Crit. Rev. Biochem.* 21:53–118.
- Dos Remedios, C. G., R. G. Yount, and M. F. Morales. 1972. Individual states in the cycle of muscle contraction. *Proc. Natl. Acad. Sci. USA.* 69:2542–2546.
- Huxley, A. F., and R. M. Simmons. 1971. Proposed mechanism of force generation in striated muscle. *Nature (Lond.)*. 233:533–538.
- Huxley, H. E. 1969. The mechanism of muscular contraction. *Science (Wash. DC)*. 164:1356–1366.
- Huxley, H. E., and M. Kress. 1985. Crossbridge behaviour during muscle contraction. *J. Muscle Res. Cell Motil.* 6:153–161.
- Huang, Y.-P., M. Kimura, and K. Tawada. 1990. Covalent cross-linking of myosin subfragment 1 and heavy meromyosin to actin at various molar ratios: different correlations between ATPase activity and crosslinking extent. *J. Muscle Res. Cell Motil.* 11:313–322.
- Jenkins, F. A., and H. E. White. 1957. *Fundamentals of Optics*. McGraw-Hill, New York. pp. 524–531.
- Kinosita, K., H. Itoh, S. Ishiwata, K. Hirano, T. Nishizaka, and T. Hayakawa. 1991. Dual-view microscopy with a single camera: real time imaging of molecular orientations and calcium. *J. Cell Biol.* 115:67–73.
- Laemmli, U. K. 1970. Cleavage of structural proteins during the assembly of the head of bacteriophage T4. *Nature (Lond.)*. 227:680–685.
- Miki, M., T. Kouyama, and K. Mihashi. 1976. Fluorescence study of  $\epsilon$ -ADP bound to rabbit F-actin: structural change in the adenine subsite of F-actin under the influence of heavy meromyosin. *FEBS Lett.* 66:98–101.
- Mornet, D., R. Bertrand, P. Pantel, E. Audemard, and R. Kassab. 1981a. Structure of the actin-myosin interface. *Nature (Lond.)*. 292:301–306.
- Mornet, D., R. Bertrand, P. Pantel, E. Audemard, and R. Kassab. 1981b. Proteolytic approach to structure and function of actin recognition site on myosin heads. *Biochemistry*. 20:2110–2120.

- Oosawa, F., S. Fujime, S. Ishiwata, and K. Mihashi. 1973. Dynamic properties of F-actin and thin filaments. *Cold Spring Harbor Symp. Quant. Biol.* 37:277-285.
- Ostap, E. M., T. Yanagida, and D. D. Thomas. 1992. Orientational distribution of spin-labeled actin oriented by flow. *Biophys. J.* 63:966-975.
- Prochniewicz-Nakayama, E., T. Yanagida, and F. Oosawa. 1983. Studies of conformation of F-actin in muscle fibers in the relaxed state, rigor and during contraction using fluorescent phalloidin. *J. Cell Biol.* 97:1663-1667.
- Selvin, P. R., B. A. Scalettar, J. P. Langmore, D. Axelrod, M. P. Klein, and J. E. Hearst. 1990. A polarized photobleaching study of chromatin re-orientation in intact nuclei. *J. Mol. Biol.* 214:911-922.
- Spudich, J., and S. Watt. 1971. The regulation of rabbit skeletal muscle contraction. I. Biochemical studies of the interaction of the tropomyosin-troponin complex with actin and the proteolytic fragments of myosin. *J. Biol. Chem.* 246:4866-4871.
- Stein, R. A., R. D. Ludescher, P. S. Dahlberg, P. G. Fajer, R. C. Bennet, and D. D. Thomas. 1990. Time resolved rotational dynamics of phosphorescent-labeled myosin heads in contracting muscle fibers. *Biochemistry.* 29:10023-10031.
- Swartz, D. R., M. Greaser, and B. B. Marsh. 1990. Regulation of binding of subfragment 1 in isolated rigor myofibrils. *J. Cell Biol.* 111:2989-3001.
- Szczesna, D., and S. S. Lehrer. 1992. Linear dichroism of acrylodan labeled tropomyosin and myosin subfragment-1 bound to myofibrils. *Biophys. J.* 61:993-1000.
- Tawada, K. 1969. Physicochemical studies of F-actin-heavy meromyosin solutions. *Biochim. Biophys. Acta.* 172:311-318.
- Tonomura, Y., P. Appel, and M. F. Morales. 1966. On the molecular weight of myosin. II. *Biochemistry.* 5:515-521.
- Thomas, D. D. 1987. Spectroscopic probes of muscle cross-bridge rotation. *Annu. Rev. Physiol.* 49:691-709.
- Thomas, D. D. 1993. Freeze! Don't even move your head. *Biophys. J.* 64:297-298.
- Thomas, D. D., and R. Cooke. 1980. Orientation of spin-labeled myosin heads in glycerinated muscle fibers. *Biophys. J.* 32:891-905.
- Thomas, D. D., J. C. Seidel, and J. Gergely. 1979. Rotational dynamics of spin labeled F-actin in the sub-millisecond time range. *J. Mol. Biol.* 132:257-273.
- Tregear, R. T., and R. A. Mendelson. 1975. Polarization from a helix of fluorophores and its relation to that obtained from muscle. *Biophys. J.* 15:455-467.
- Velez, M., K. F. Barald, and D. Axelrod. 1990. Rotational diffusion of acetylcholine receptors on cultured rat myotubes. *J. Cell Biol.* 110:2049-2059.
- Weeds, A. G., and R. S. Taylor. 1975. Separation of subfragment-1 isoenzymes from rabbit skeletal muscle myosin. *Nature (Lond.)*. 257:54-56.
- Wilson, M. G. A., and R. A. Mendelson. 1983. A comparison of order and orientation of cross-bridges in rigor and relaxed muscle fibers using fluorescence polarization. *J. Muscle Res. Cell Motil.* 4:671-693.
- Yamamoto, K., and T. Sekine. 1986. Difference between subfragment-1 and heavy meromyosin in their interaction with F-actin. *J. Biochem.* 99:199-206.
- Yanagida, T. 1981. Angles of nucleotides bound to cross-bridges in glycerinated muscle fiber at various concentrations of  $\epsilon$ -ATP,  $\epsilon$ -ADP and  $\epsilon$ -AMPPNP detected by polarized fluorescence. *J. Mol. Biol.* 146:539-560.