

THE MEDIAL INCLINATION OF THE HUMAN THORACIC INTERVERTEBRAL ARTICULAR FACETS

By P. R. DAVIS

Royal Free Hospital School of Medicine, London

INTRODUCTION

The human inferior thoracic intervertebral articular facets are very slightly concave in both the vertical and transverse planes; they face forwards with some medial and a little inferior inclination; the superior articular facets are shaped to conform with them.

Humphry (1858) stated that a pair of thoracic facets 'may be regarded as forming two portions of one circle, the centre of which is about the middle of the body of the vertebra, or an approximation to this'. Holden (1887) agreed, but Hughes (1892) thought, that if indeed the facets lie on the circumference of one circle, the centre of that circle must lie in front of the vertebral body.

It is generally agreed that the directions of movement at a given intervertebral articulation are controlled principally by the shape of the articular facets, the mode of rotation of the thoracic column being determined principally by their medial inclination. Experiments carried out by Hughes (1892), Lovett (1900, 1905, 1906), Novogrodsky (1911), and Andersson & Eckström (1941) have demonstrated that considerable rotation occurs between successive thoracic vertebrae from the second to the ninth inclusive, and that below this the amplitude decreases, there being little rotation at the thoraco-lumbar transition. Lovett also noted that rotation is accompanied by lateral flexion, an observation confirmed by Dittmar (1931) and Arkin (1950). Several explanations of this phenomenon have been put forward (Lovett, 1906; Feiss, 1907; Rogers, 1938; and others), the theories, which are not fully accepted, being based on the behaviour of series of blocks of wood or of rods of pliable material. Little attention appears to have been paid to the medial inclination of the articular facets, a feature which must be considered in any attempt to resolve the problem of factors responsible for the association of rotation and lateral flexion in the thoracic spine. To this end the inclination of the thoracic intervertebral facets has been measured in seventeen vertebral columns.

MATERIAL

Seventeen macerated and dried adult vertebral columns were selected, all columns being serially complete, undamaged, and free from congenital or pathological abnormality. Parts of two freshly macerated young adult male columns were also used in the investigation.

THEORETICAL CONSIDERATIONS

The object of the experiments was to determine the degree of medial inclination of the facets in relation to the position of the vertebral bodies, in such a manner that the results were comparable between different vertebrae and between different

columns. In Fig. 1, the dotted lines ab and cd are the chords of the arcs formed by the articular surfaces of a pair of facets of a thoracic vertebra. The extensions of these chords meet at g , forming the *facetal angle*, agd . The facetal angle gives the absolute extent of medial inclination, but does not indicate the relationship of this to the vertebral body. If, however, one considers the bisectors of the two chords, EX and FX in Fig. 1, it is apparent that the medial inclination of the facets causes the bisectors to meet at the point X , which will be referred to as the *intersection point*.

If the two facets do lie on the circumference of one circle, then X is the centre of that circle. If the facets form arcs of two different circles, as in Fig. 2, then the intersection point X will bear no clear geometrical relationship to either of the two circles p and q , but will still indicate the point towards which the facets face (Fig. 2).

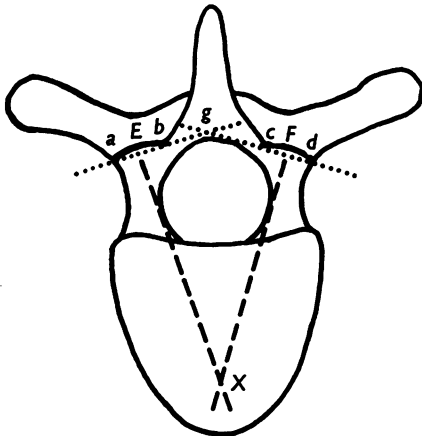

Fig. 1

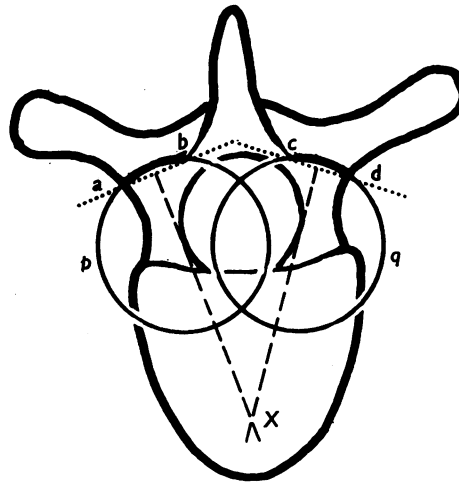

Fig. 2

Fig. 1. Diagram of the lower aspect of a thoracic vertebra, showing the construction lines used in finding the intersection point, X . The curvature of the articular facets has been exaggerated.

Fig. 2. Diagram showing that an intersection point, X , can be obtained even though the articular facets, ab , cd , lie on two separate circles, p , q .

By measuring the midline distance from the vertebral lamina to the intersection point, and to the posterior margin of the vertebral body, and expressing these as a percentage of the midline distance between the lamina and the anterior border of the vertebral body, the position of the intersection points can be expressed in relation to the position of the vertebral body, and intersection points in different vertebrae can thus be compared.

METHOD

The *inferior* intersection point (X in Fig. 3) was determined by finding the medial inclination of the inferior articular facets, using engraved Perspex sheets as shown.

The *superior* intersection point was determined similarly; parallel-sided strips of Perspex, adherent to the undersurface of the Perspex sheets, were helpful in gauging the medial inclination of the facets (see Fig. 4).

The position of the mid-points of both superior and inferior facets and the chords of the superior facets had to be judged by eye, but it was found in a series of preliminary tests that the results were reproducible for any one vertebra, the method having an apparent error of $\pm 2\%$.

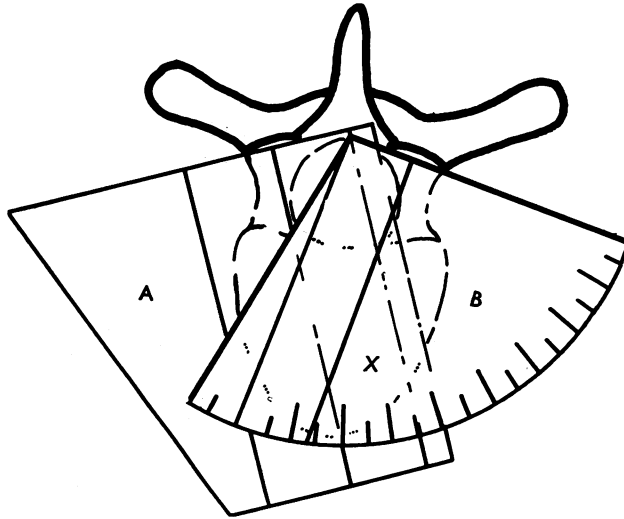

Fig. 3. Diagram to show the use of the Perspex instruments *A* and *B* to obtain the inferior intersection point, *X*, of a thoracic vertebra. The curvature of the articular facets has been exaggerated.

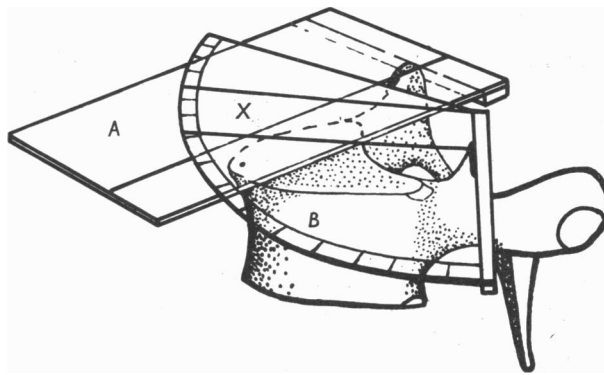

Fig. 4. Diagram to show how the Perspex strips on the undersurface of the instruments *A* and *B* were placed against the surfaces of the superior articular processes. The plane in which the instruments are lying is parallel to that of the upper surface of the vertebral body, and the point of intersection of the two lines at *X* is immediately above the intersection point on the vertebral body.

In order to make direct comparisons of the data from each vertebra, three indices were then calculated in each case, these being the upper and lower *intersection indices* and the *laminar-body length index*.

The intersection indices for the upper and lower surfaces are expressed thus:

$$\frac{\text{midline distance from lamina to intersection point} \times 100}{\text{midline distance from lamina to anterior border of body}}$$

(see $(LX \times 100)/LA$ in Fig. 5). The laminar-body length index is expressed as:

$$\frac{\text{midline distance from lamina to posterior border of body} \times 100}{\text{midline distance from lamina to anterior border of body}}$$

(see $(LP \times 100)/LA$ in Fig. 5). The measurements and the indices were tabulated. By plotting the results, a series of graphs was obtained which gave the relationship between the intersection point and the vertebral body for each vertebra measured, the results being comparable between different vertebrae and different columns.

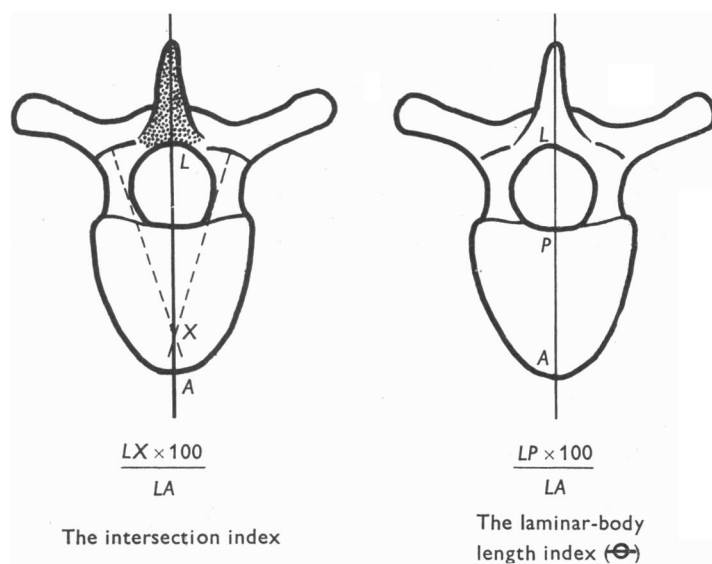

Fig. 5. Diagram to show the dimensions used to obtain the intersection and laminar-body length indices.

RESULTS

In the macerated and dried columns the facet angles of the first thoracic vertebrae were so large in three that the intersection point could not be determined. The shape and inclination of the facets of the thoraco-lumbar mortice articulation precluded the determination of the intersection point in a further three columns, and no observations could be made on the joints below the transitional level. In the seventeen dry columns, 166 joints were thus available for measurement. In one wet specimen measurement was possible at eight of the ten typical thoracic articulations, while in the other, for technical reasons, measurement was only possible at alternate joints between the second and tenth thoracic vertebra.

At all but three of these 178 articulations the intersection point for the superior facets of the inferior vertebra forming the joint lay nearer the lamina than did the intersection point for the inferior facets of the upper vertebra. The three exceptions

occurred at one articulation in each of three dry columns, at T2-3 in one, T8-9 in the second and T9-10 in the third. At no joint did the intersection points lie behind the junction of the anterior two-thirds of the vertebral body with the posterior third.

Comparison of the intersection points at different levels showed that in all columns they lay in front of the vertebral bodies in the upper one or two thoracic vertebrae. Below this, ten dry and the relatively complete wet column (Fig. 6a)

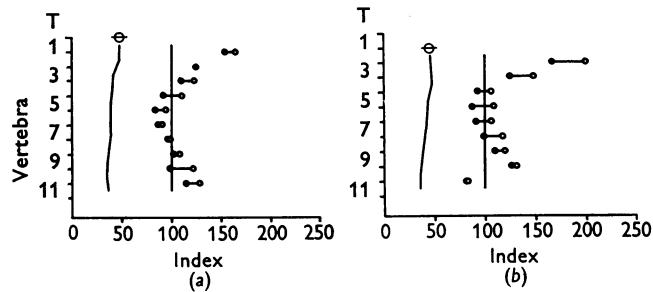

Fig. 6. The relative positions of the superior intersection index (●) and the inferior intersection index (○) at each of the thoracic intervertebral joints in two vertebral columns. Index 0 indicates the position of the anterior surfaces of the laminae in the midline. ⊖ indicates the posterior margins, and index 100 the anterior margins, of the vertebral bodies.

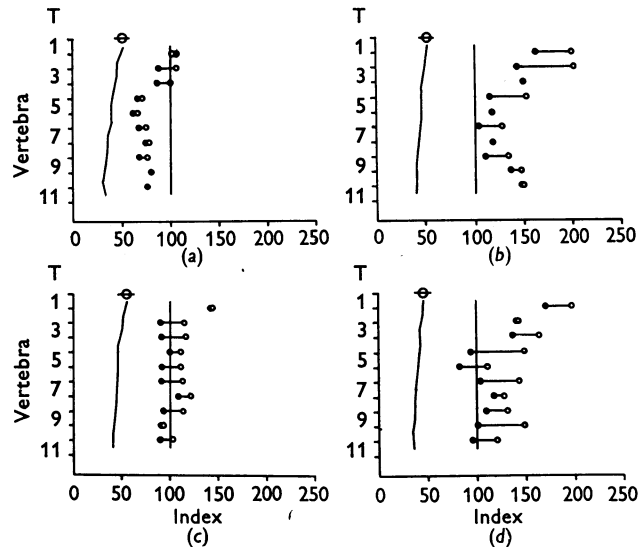

Fig. 7. The positions of the intersection indices in four columns. The symbols have the same meaning as in Fig. 6.

had a similar pattern of change, in that the intersection points approached the anterior border of the column of vertebral bodies, and either the superior or both intersection points entered the lines of the bodies; lower still the points become more anterior and left the line of the bodies again. In four of the ten dry columns (Fig. 6b) the intersection points for the joint between the tenth and eleventh thoracic

vertebrae lay more posteriorly than those for the joint immediately above, re-entering the line of the bodies.

Three dry columns (Fig. 7*a*) had a pattern similar to that of the preceding ten, in that the points entered the line of the bodies in the upper part, but differed below since the points remained within the line of the bodies. The available articulations in the second wet specimen were of similar inclinations.

Of the four remaining columns, one (Fig. 7*b*) had points above and below which were farther forward than the mid-thoracic points, but at no level did they enter the bodies; two (Fig. 7*c*) had points which lay close to the anterior line from the second thoracic joint downwards; and one (Fig. 7*d*) had points which entered the column below the fourth thoracic vertebrae, left it below this level, and re-entered the column below the ninth thoracic vertebra.

DISCUSSION

The effects upon bony dimensions of maceration and drying have been studied by Ingalls (1927) and Todd & Pyle (1928), who found that the amount of shrinkage produced was relatively small. The articular cartilage of the intervertebral facets is thin and appears to be evenly spread over the bony surface. Drying and cartilage deprivation thus appear unlikely to have had any material effect on the results obtained in the dry columns.

It has been shown that the majority of intervertebral joints in the thoracic region have a greater intersection index for the inferior facets of the upper participating vertebra than for the superior articular facets of the lower participating vertebra. So that if the pairs of facets do lie on single arcs, then the radius of the arc of the pair of inferior facets of the upper vertebra is greater than the radius of the pair of facets with which they articulate: this means that there is a certain looseness of fit, a looseness described by MacConaill (1953) as incongruence, and as a characteristic of synovial joints. Clearly this incongruence will permit lateral flexion during rotation, but by itself cannot cause this associated movement.

If it is accepted that the articular facets constitute a guiding element during vertebral rotation, one may deduce that the centres of rotation of the upper thoracic vertebrae are well in front of the vertebral bodies in most cases: in the mid-thoracic segments the centres approach and in many cases lie within the line of the bodies: and in the lower thoracic segments in many columns the centres again lie in front of the vertebral bodies, with the exception of some of the lowest typical thoracic joints. Owing to the thoracic kyphos, the upper and lower thoracic vertebrae lie in a plane anterior to that of the middle members of the series; the anterior position of the axes of rotation in these upper and lower thoracic segments must therefore be even more marked when related to the intact body. Superiorly, and in some cases inferiorly, where the axis of rotation lies well in front of the bodies, simple rotation should be accompanied by a sideways shearing movement of the vertebral bodies, whereas in the middle of the region the centre of rotation must lie in the intervertebral discs. The thinness of the thoracic intervertebral discs must prevent any great lateral shearing at the upper and lower joints.

It is clear that the two original opinions of Humphry and Holden, and of Hughes,

are not as opposed as they at first sight might have seemed. Humphry and Holden, who thought the arcs were centred within the vertebrae, were correct in so far as the middle thoracic vertebrae are concerned, and Hughes, who placed the centres in front of the bodies, was correct as far as the upper and some of the lower thoracic vertebrae are concerned.

The variability in behaviour of the intersection points in this series may well be due to sexual or racial differences, but there is no evidence available as to the effect of these factors.

SUMMARY AND CONCLUSIONS

The medial inclination of the thoracic intervertebral articular facets is best measured by determining the position of the intersection points.

In seventeen complete dry and two incomplete wet columns this measurement has revealed a considerable degree of individual variation. Commonly the upper one or two thoracic articulations have points well in front of the vertebral body, those below approaching and then entering the line of the vertebral bodies; in the lower part of the region the points again leave this line in most cases, except that the lowest thoracic joint may have points which re-enter the line. Simple rotation can thus occur in the mid-thoracic region, but elsewhere rotation must be accompanied by a lateral shearing of the bodies. The incongruity of the pairs of articulating facets is sufficient to permit associated lateral flexion of the column, although it is not necessarily a cause of this movement.

REFERENCES

- ANDERSSON, N. & ECKSTRÖM, T. (1941). Über die Beweglichkeit der Wirbelsäule. *Gegenbaurs Jb.* **85**, 135-185.
- ARKIN, A. M. (1950). The mechanism of rotation in combination with lateral deviation in the normal spine. *J. Bone Jt. Surg.* **32-A**, 180-188.
- DITTMAR, O. (1931). Roentgenstudien zur Mechanologie der Wirbelsäule. *Z. orthopäd. Chir.* **55**, 321-351.
- FEISS, H. O. (1907). The mechanics of lateral curvature. *Amer. J. orthop. Surg.* **5**, 152-179.
- HOLDEN, L. (1887). *Osteology*, 7th ed. London.
- HUGHES, A. W. (1892). Die Drehbewegungen der menschlichen Wirbelsäule, und die sogenannten Musculi rotatores (Theile). *Arch. Anat. Physiol., Lpz.*, 265-280.
- HUMPHRY, G. M. (1858). *A Treatise on the Human Skeleton (Including the Joints)*. London.
- INGALLS, N. W. (1927). Studies on the femur. III. The effects of maceration and drying in the white and the negro. *Amer. J. Phys. Anthropol.* **10**, 297-321.
- LOVETT, R. W. (1900). Movements of the normal spine in their relation to scoliosis. *J. Boston Soc. med. Sci.* **4**, 243.
- LOVETT, R. W. (1905). The mechanism of the normal spine and its relation to scoliosis. *Boston med. Surg. J.* **153**, 349-358.
- LOVETT, R. W. (1906). The treatment of lateral curvature of the spine. *J. Amer. Med. Ass.* **46**, 1915-1922.
- MACCONAILL, M. A. (1953). The movements of bones and joints. 5. The significance of shape. *J. Bone Jt. Surg.* **35-B**, 290-297.
- NOVOGRODSKY, M. (1911). Die Bewegungsmöglichkeit in der menschlichen Wirbelsäule. Thesis, Bern.
- ROGERS, S. P. (1933). Mechanics of scoliosis. *Arch. Surg.* **26**, 962-980.
- TODD, T. W. & PYLE, S. I. (1928). Effects of maceration and drying upon the vertebral column. *Amer. J. phys. Anthropol.* **12**, 303-319.