

EFFECTS OF TETRAETHYLAMMONIUM CHLORIDE ON CONTRACTILE, MEMBRANE AND CABLE PROPERTIES OF RABBIT ARTERY MUSCLE

BY G. HAEUSLER AND S. THORENS

*From the Pharma Research Department, F. Hoffmann-La Roche & Co. Ltd,
CH-4002 Basle, Switzerland*

(Received 28 June 1979)

SUMMARY

1. Two types of effects of tetraethylammonium chloride (TEA) have been found in the smooth muscle cells of the rabbit main pulmonary artery. (a) With rapid onset of action TEA depolarizes the cell membrane, increases the membrane resistance, causes anomalous rectification and occasionally spike potentials in response to externally applied depolarizing current pulses and produces tonic contractions. (b) During prolonged (> 30 min) incubation in TEA phasic contractions develop progressively and the vascular strips respond to electrical stimulation with synchronized and powerful contractions.

2. There is a linear relationship between log concentration TEA and depolarization over the range of 10–100 mM-TEA. TEA (10 and 30 mM) raises the membrane resistance and decreases the core resistance. The latter effect appeared to develop more slowly than the former.

3. During short exposure to TEA part of the smooth muscle cells respond to depolarizing current pulses with spike potentials of variable amplitude and duration. These spikes are very sensitive to inhibition by verapamil or nickel chloride but are not affected by tetrodotoxin. The amplitude of electrotonic potentials, increased by TEA, is slightly further elevated by verapamil or nickel chloride.

4. TEA (10 mM) increases the mechanical response to low and intermediate potassium concentrations but has no effect on maximal contractions to high potassium. The slope of the line relating log potassium concentration to membrane potential is decreased by TEA.

5. TEA (10 mM) shifts the concentration response curve for the contractile effect of noradrenaline to the left and increases the maximum of noradrenaline-induced contractions. In the presence of TEA, noradrenaline reduces the membrane potential to markedly lower values than under control conditions.

6. It is concluded that the rapidly occurring effects of TEA on the vascular smooth muscle cells of the rabbit main pulmonary artery are a decrease in potassium and an increase in calcium conductance. The latter effect may be related to a blockade of potassium channels; however, we cannot rule out the possibility that TEA affects calcium conductance independent of its presumed action on potassium channels. The slowly developing effects of TEA may be ascribed to the formation of gap junctions and/or (less likely) to an intracellular accumulation of TEA.

INTRODUCTION

Tetraethylammonium (TEA), originally of interest as an antagonist of the effects of acetylcholine in autonomic ganglia, is now widely used in electrophysiological experiments as a tool to reduce the potassium conductance of the membrane of excitable cells. TEA diminishes in nerves and skeletal muscle the time-dependent changes in potassium conductance that occur upon depolarization of the cell membrane (Armstrong & Binstock, 1965; Hille, 1967; Koppenhöfer, 1967; Stanfield, 1970, 1973). As a consequence of this, the action potential is prolonged and this is associated in skeletal muscle with an increased twitch response without alteration or the height of tetanic tension (Kao & Stansfield, 1970; Sandow, 1970).

In smooth muscle cells of different origin TEA increases the amplitude and prolongs the duration of spontaneously occurring action potentials, for example, in guinea-pig taenia coli (Suzuki, Nishiyama & Inomata, 1963), in antral circular muscle of the guinea-pig stomach (Ito, Kuriyama & Sakamoto, 1970) and in antral longitudinal muscle of the dog stomach (Szurszewski, 1978). TEA induces spikes in those types of smooth muscle which do not normally generate action potentials such as the guinea-pig fundus (Osa & Kuriyama, 1970), the rabbit common carotid artery (Mekata, 1971), bovine or canine tracheal smooth muscle (Kirkpatrick, 1975; Kroeger & Stephens, 1975) and the rat anococcygeus muscle (Creed, Gillespie & Muir, 1975). In addition, TEA enhances the contractile responses to various agonists, an effect most frequently described for vascular smooth muscle preparations (Lum & Rashleigh, 1961; Bevan, 1963; Kelkar, Gulati & Gokhale, 1964; Thoenen, Haefely & Staehelin, 1967; Choi & Di Palma, 1973; Kalsner, 1973; Haeusler, 1978).

Recently, Kannan & Daniel (1978) reported the formation of gap junctions and the appearance of spontaneous mechanical activity upon exposure of canine isolated tracheal smooth muscle to either of two potassium conductance blockers, TEA and 4-aminopyridine. These effects of TEA or 4-aminopyridine may be interpreted as representing a conversion from multi-unit to single-unit type of behaviour in tracheal smooth muscle.

In the course of investigations on excitation-contraction coupling in the rabbit main pulmonary artery, a vascular smooth muscle which does not generate action potentials (Somlyo & Somlyo, 1968; Somlyo, Vinnall & Somlyo, 1969), we observed that TEA produced slow tonic contractions of rapid onset associated with an increase in intracellular calcium concentration and with an enhancement of the contractile responses to noradrenaline and high potassium. Long-lasting exposure of the rabbit main pulmonary artery to TEA led to the induction of spontaneous mechanical activity. This paper and the following one (Haeusler, Kuhn & Thorens, 1980) report the results obtained with TEA over a wide concentration range and deal with the question whether the various actions of TEA are related to one single pharmacological property.

METHODS

Preparations of vascular strips. Rabbits (Burgunder) of either sex supplied by the breeding unit Füllinsdorf and weighing 2.3–3.0 kg were stunned and bled. The main pulmonary artery was excised, transferred immediately to an oxygenated physiological salt solution, cleaned from adhering connective tissue under a dissecting microscope, and opened along its long axis. Two

2 mm wide strips from the middle part of the vessel were then cut parallel to the circular muscle coat, the length of the strips being identical to the circumference of the artery.

Recording of mechanical responses. The vascular strips were mounted in a 10 ml. organ bath and connected to a Statham force transducer for semi-isometric recording of contractions. An equilibration period of 45 min was allowed to elapse before starting the experiments. During this time, the physiological salt solution was replaced every 5 min. The resting tension of the arterial strips was 2 g. This resulted in an extension of the vascular strips to approximately 150% of their *in vitro* length when unloaded. The dose-response curves of TEA, potassium and noradrenaline were obtained in a cumulative way. In the case of TEA and potassium the change from one concentration to the next was achieved by replacement of the preceding solution. In the case of noradrenaline, the transmitter was injected into the organ bath in volumes of 0.05 ml. for each concentration. Only one concentration-response curve was obtained in a single strip.

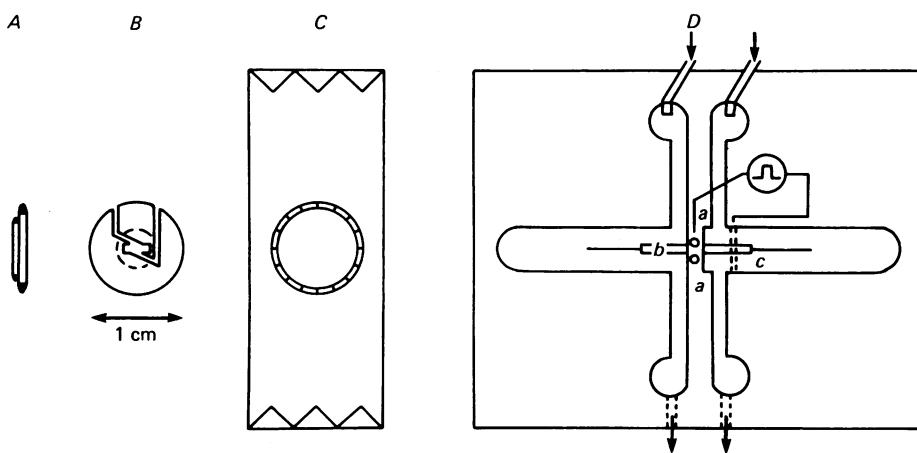

Fig. 1. Schematic drawing of the muscle chamber (*D*) which is divided by partition (*a*) into two compartments, stimulating (right) and recording (left). Part *C* of the Figure shows the lateral aspect of partition (*a*) containing a hole of 1 cm diameter to house one of the stimulating electrodes (*B*). The channels of *B* are filled with agar dissolved in physiological salt solution and fine silver-silver chloride electrodes are introduced into the agar channels. The vascular strip (*b*) is pulled through the central slit of *B* and stimulated through the agar bridge. The second electrode (*c*) contains also an agar bridge. Electrical isolation towards the recording compartment is achieved by a fine rubber membrane put into the left surface of *B* and held in place by a rubber fitting (see part *A* of the Figure which shows a cross section of *B*). The rubber membrane fits tightly around the vascular strip. Finally *B* is pushed into the hole of *C*; electrical isolation in the muscle chamber are made of Perspex.

Measurement of membrane potential and cable properties. Strips of the rabbit main pulmonary artery were prepared in the same way as described above and subsequently introduced into a partition chamber apparatus. Initially we have used an apparatus which was very similar to that described by Abe & Tomita (1968). However, difficulties were encountered by the use of thin silver plates for stimulation as recommended by Abe & Tomita. Repeated stimulation of the vascular strips produced electrolytic lesions at the sites in contact with the silver electrodes and resulted in progressive deterioration of the electrotonic potentials within 30–60 min. With a newly designed apparatus, where a disk-shaped electrode is introduced into the partition wall (Fig. 1), the vascular smooth muscle was stimulated electrically through agar bridges that were in contact with both the endothelial and adventitial surfaces of the strip. The inter-electrode distance was 9 mm. Constant current pulses of 3 sec duration were delivered by a constant-current stimulator (Nuclear Chicago, Model 7150). The current strengths applied were in all experiments 10, 30, 50, 70 and 90 μ A. Since an unknown, but large part of the current

passed through the extracellular space and the physiological salt solution surrounding the vascular strip, only relative values can be given for the current that flows across the cell membrane and produces electrotonic potentials (Figs. 6–8). During exposure of the cells to depolarizing solutions a second-current stimulator allowed the application of conditioning hyperpolarization in order to return the membrane potential to the resting value and to determine the current-voltage relationship under defined conditions. By the use of agar bridges for electrical stimulation highly reproducible results were obtained and the strips tolerated experiments of 4–6 hr duration without any sign of damage.

The recording as well as the stimulating chamber had volumes of 3 ml. and were each perfused at a rate of 1.5 ml./min. The free end of the vascular strip in the recording chamber was connected with a thread to a Statham forces transducer for semiisometric measurement of contractions. These measurements were used only for control purposes. The resting tension of the strip was 2 g.

Intracellular recordings of the membrane potential and of electrotonic potentials were obtained from the endothelial side of the vessel with glass capillary micro-electrodes filled with 3 M-potassium chloride. The resistance of the electrodes varied between 20 and 35 M Ω and the tip potentials between 3 and 10 mV. The electrodes were tested at regular intervals for tip potentials in order to avoid systematic errors. The glass micropipettes were suspended from a fine, flexible silver wire glued into the shank of the electrode and connected to a Mentor N-950 intracellular probe system. The criterion for a successful cell impalement was the occurrence of an instantaneous change in voltage. Only those penetrations were included into the calculations in which the membrane potential had stabilized after impalement for at least 1 min. In many cases much longer recordings were obtained. Upon withdrawal of the electrode the initial zero line was regained and the electrode resistance was unchanged. Both changes in membrane potential and in contractile state were displayed on the screen of an oscilloscope and on the recording paper of a polygraph (F. Hellige, Helcoscriptor HE-17). Furthermore, all data were stored on magnetic tape.

Solutions. The standard solution was a physiological salt solution of the following composition (mM concentrations): NaCl 135, KCl 3.7, CaCl₂ 2.25, MgSO₄ 0.8, NaH₂PO₄ 0.4; NaHCO₃ 12, glucose 5.5. The solution was gassed with 95% (v/v) O₂ and 5% (v/v) CO₂, its pH was 7.3–7.4, its temperature 37 °C. Isotonic TEA or potassium solutions were prepared by replacement of sodium chloride with equimolar amounts of TEA chloride or potassium chloride. Calcium-free solutions were prepared by omission of calcium from the solution without addition of EGTA. The following drugs were used at concentrations given under Results: atropine sulphate (C. H. Boehringer Sohn, Ingelheim, Germany); 6-hydroxydopamine (F. Hoffmann-La Roche, Basel, Switzerland); hydrated nickel chloride (E. Merck, Darmstadt, Germany); L-noradrenaline (Fluka AG, Buchs SG, Switzerland); phentolamine and reserpine (CIBA-GEIGY AG, Basel, Switzerland); tetraethylammonium chloride (Eastman Kodak Co., Rochester, N.Y., U.S.A.); tetrodotoxin (Sankyo Co., Tokyo, Japan); verapamil (Knoll AG, Ludwigshafen, Germany).

Statistics. Mean values are given \pm s.e. of mean. The Student's *t* test was used for determining the statistical significance of differences between mean values.

RESULTS

Effect of TEA on contractile state and membrane potential. TEA produced tonic contractions of the rabbit main pulmonary artery in a concentration-dependent manner (Figs. 2–4). This effect of TEA was not influenced to any major degree by depletion of noradrenaline stores or by destruction of adrenergic nerve endings resulting from pretreatment of the rabbits with reserpine (two experiments) or 6-hydroxydopamine (two experiments), respectively. Similarly, the contractile response to TEA remained unaltered when the α -adrenoceptor blocking agent phentolamine (10^{-6} M) was added to the bath fluid (four experiments) or when muscarine receptors were blocked by atropine (10^{-6} M) (five experiments). These findings rule out the possibility that the contractions to TEA are produced by a release of

noradrenaline from adrenergic nerve endings or through a stimulation of muscarine receptors of the vascular smooth muscle cells. When TEA was added to the physiological salt solution, i.e. when the sodium content of the solution remained normal but tonicity increased, the contractile effect of TEA was virtually indistinguishable from that produced by a solution with reduced sodium content ($n = 10$, results not shown). Apparently, the contractions are not the result of an inhibition of sodium-calcium exchange (Reuter, Blaustein & Haeusler, 1973) due to the reduction of external sodium.

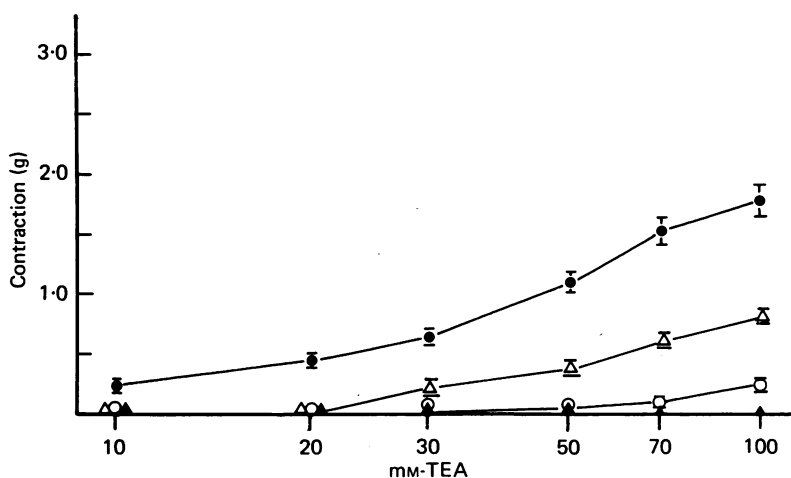

Fig. 2. Concentration-response curves of TEA in the rabbit main pulmonary artery. Contractions were elicited by replacement of sodium chloride by equimolar amounts of TEA chloride in non-pretreated vascular strips (filled circles, $n = 10$), after prior incubation of the strips for 15 min (open circles, $n = 5$) or 30 min (filled triangles, $n = 5$) in calcium-free solution or in the presence of verapamil (10^{-6} M) in the bath fluid (open triangles, $n = 6$). Shown are the mean values (\pm s.e. as vertical bars).

The contractions induced by TEA were virtually abolished by prior incubation of the vascular strips for 15 min in a calcium-free solution and totally abolished when the incubation was extended to 30 min (Fig. 2). In the presence of verapamil (10^{-6} M), the TEA-induced contractions were markedly reduced (Fig. 2). These findings indicate a strict dependence of the TEA-induced contractions on extracellular calcium and to this extent the contractions resemble those to high potassium which, in the pulmonary artery of the rabbit, also require the presence of calcium in the bath fluid (Haeusler, 1972*b*).

The resting membrane potential of the vascular smooth muscle cells of the rabbit main pulmonary artery measured with intracellular glass micro-electrodes was found to vary between -56 and -62 mV with a mean of approximately -59 mV for several control groups. This value is in good agreement with those of previous reports on the pulmonary artery of the rabbit (Somlyo & Somlyo, 1968; Somlyo *et al.* 1969; Haeusler, 1972*a*; Casteels, Kitamura, Kuriyama & Suzuki, 1977*a*). Fig. 3 shows two successful recordings of the membrane potential during contractions of the vascular strips in response to TEA (10 and 20 mM). Concentrations of TEA above 20 mM produced more pronounced contractions which mostly dislodged the intracellular

micro-electrode. TEA reduced the membrane potential in a concentration-dependent manner (Fig. 4). At the concentrations of 10 and 20 mM-TEA, depolarization preceded contraction (Fig. 3). The depolarization in response to TEA was maintained over periods of up to 120 min. During wash-out of TEA the membrane potential returned to its initial value within 5–15 min.

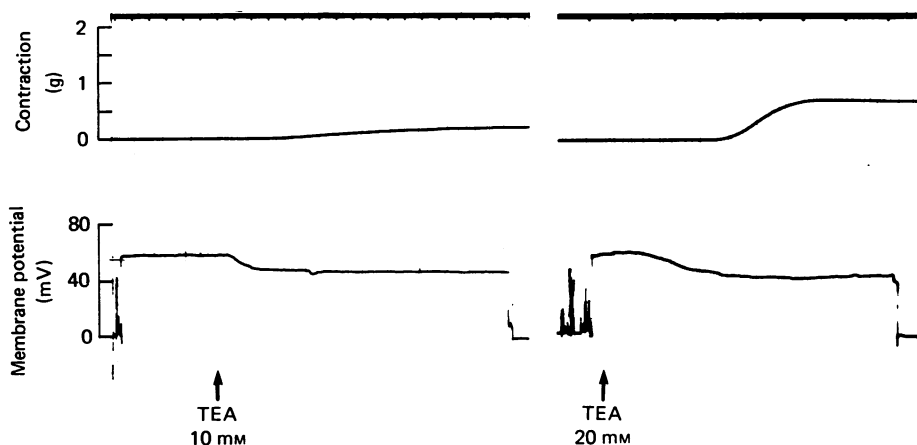

Fig. 3. Simultaneous recording of tension and membrane potential in two different strips of rabbit main pulmonary artery exposed to either 10 or 20 mM-TEA. The time calibration at the top of the recordings is 1 min.

Verapamil (10^{-6} M) had no influence on the magnitude of the depolarization produced by TEA in concentrations of 10, 20 and 30 mM (higher concentrations were not tested), however, the drug abolished or reduced the TEA-induced contractions.

Effect of TEA on membrane properties. The membrane of the vascular smooth muscle cells of the rabbit main pulmonary artery did not show spontaneous potential changes or spikes. Even depolarizing current pulses did not elicit action potentials (Fig. 5). Fig. 5 shows electrotonic potentials evoked by extracellularly applied depolarizing and hyperpolarizing currents and recorded with an intracellular micro-electrode in the extrapolar region at different distances from the stimulating electrode. For hyperpolarizing current pulses there was a linear relationship between current and electrotonic potential (Fig. 6A–C). Application of depolarizing current pulses revealed marked outward rectifying properties of the membrane (Figs. 5 and 6). A mechanical response of the vascular strip was never observed in response to cathodal current pulses in the absence of TEA.

Fig. 6A shows the decay of the amplitude of the electrotonic potentials with distance from the anode. The decay was exponential, i.e. a plot of the log of the electrotonic potential (mV) against distance (mm) revealed in all cases a straight line. The space constant (λ) which is given by the distance at which the amplitudes of the electrotonic potentials decline to a relative size of $1/e$ or 37% was calculated to be 1.83 ± 0.11 mm (6 strips of pulmonary artery). The plot of the half-rise time of the electrotonic potentials against the distance from the stimulating electrode yielded a straight line with a slope of 54 msec/mm. This slope is also defined by $\tau_m/2\lambda$ and thus allows the calculations of the time constant (τ_m). We found a value of 208 ± 28 msec

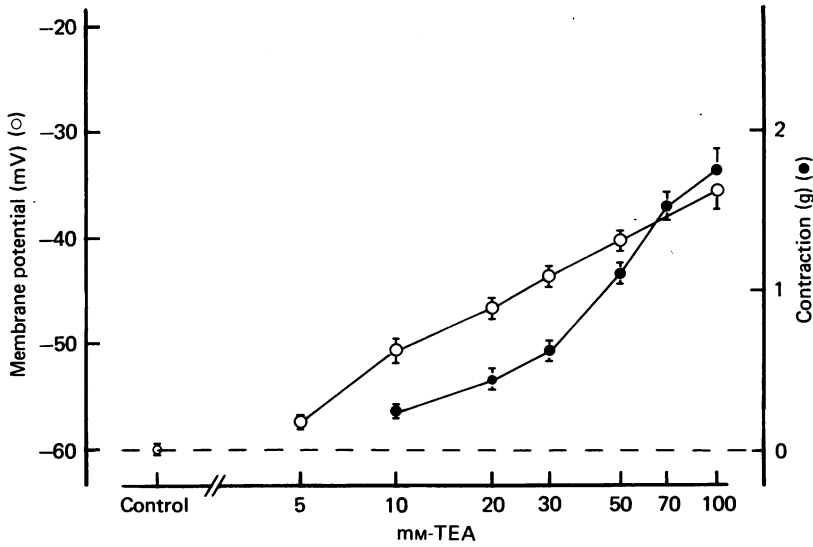

Fig. 4. Concentration response curves for the contractile effect (filled circles) of TEA in strips of rabbit main pulmonary artery and for the TEA-induced depolarization (open circles) of the vascular smooth muscle cells. Shown are the mean values (\pm s.e. as vertical bars) of ten vascular strips (contraction) and of at least forty intracellular measurements for each concentration of TEA.

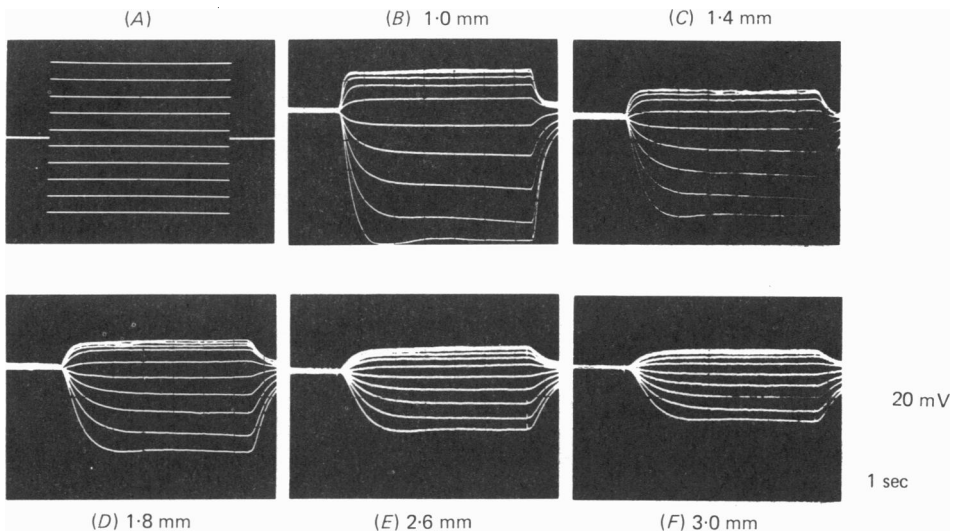

Fig. 5. Responses of the membrane of vascular smooth muscle cells of the rabbit main pulmonary artery to externally applied cathodal or anodal current pulses of 3 sec duration. Intracellular records of electrotonic potentials (*B-F*) at five different distances from the stimulation electrode in response to 5 different current intensities of 10, 30, 50, 70 and 90 μ A (*A*). Depolarization and cathodal current upward, hyperpolarization and anodal current downward. Membrane potential -59 mV.

for τ_m in the rabbit main pulmonary artery. Rather similar values have been reported by Casteels *et al.* (1977*a*), namely 1.48 mm for λ and 182 msec for τ_m . In agreement with earlier reports (Somlyo & Somlyo, 1968; Somlyo *et al.* 1969; Haeusler, 1972*a*; Casteels *et al.* 1977*a*), it was confirmed that the smooth muscle cells of the rabbit main pulmonary artery do not contract spontaneously, that they do not generate spike potentials either spontaneously or under the influence of noradrenaline or high potassium, and that they respond to the two vasoconstrictor stimuli with graded depolarization and tonic contraction.

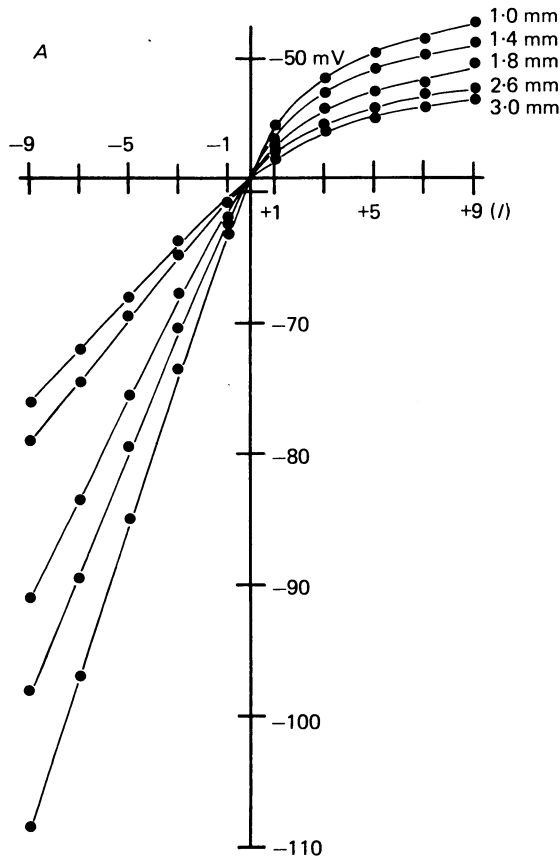

Fig. 6 *A*, an example of the current-voltage relationship of the smooth muscle of the rabbit main pulmonary artery measured at various distances from the stimulating electrode. Abscissa, intensity of externally applied current (arbitrary units). Ordinate, intracellularly recorded membrane potential (mV).

TEA, 10 and 30 mM, increased the amplitude of the electrotonic potentials and reduced the rectifying property of the cell membrane (Fig. 6*B*). In five strips in which TEA, 10 and 30 mM, were studied consecutively, with a 2 hr wash-out period between the exposures to TEA, the space constant increased (Table 1). The experimental conditions under which λ was determined at the TEA concentrations of 10 and 30 mM differed insofar as the sampling of electrotonic potentials at 10 mM-TEA was carried out between 20 and 60 min after administration of TEA while at

30 mM-TEA this period was 5–30 min. During prolonged incubation (> 30 min) with 30 mM-TEA even hyperpolarizing current pulses induced spontaneous contractions with the resulting dislodgement of the intracellular micro-electrode. There was no further increase in the amplitude of the evoked electrotonic potentials and in the space constant when the concentration of TEA was raised to 50 mM (three experiments) or 70 mM (two experiments). On the contrary, the values were slightly lower than those found with TEA 30 mM. However, the validity of these measurements is limited since it was extremely difficult to obtain prolonged intracellular recordings in the presence of such high concentrations of TEA.

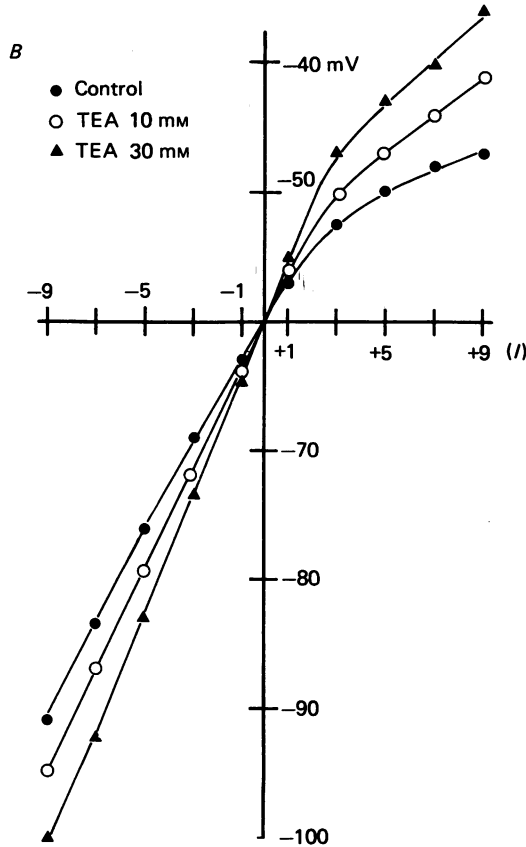

Fig. 6. *B*, current-voltage relationship of the rabbit main pulmonary artery as influenced by two concentrations of TEA (10 and 30 mM). All three curves were obtained from the same cell in the sequence control, TEA 10 mM and TEA 30 mM. The membrane potential was -60 mV under control conditions, -49 mV in the presence of 10 mM and -43 mV in the presence of 30 mM-TEA. The low membrane potential in the presence of TEA was returned to the control value by current injection through the external electrodes before the current pulses for measurement of membrane properties were applied. The distance between the external stimulating electrode and the intracellular micro-electrode was 1 mm. In this particular cell outward current pulses did not elicit action potentials with either of the two concentrations of TEA. Abscissa, intensity of externally applied current (arbitrary units). Ordinate, intracellularly recorded membrane potential (mV).

In eight cases we were able to measure in the same vascular smooth muscle cell the current-voltage relationship under three different experimental conditions, namely control, TEA 10 mM and TEA 10 mM + verapamil 10^{-6} M ($n = 5$) or control, TEA 10 mM and TEA 10 mM + nickel chloride 10^{-3} M ($n = 3$). When verapamil or nickel chloride, two agents which are thought to reduce calcium permeability, were added to the TEA-containing solution, the amplitudes of the electrotonic potentials increased slightly and to a similar extent after both agents. An example is shown in Fig. 6C. In only one out of eight cells did the electrotonic potential not change (addition of verapamil). Exposure of control strips to verapamil ($n = 6$) had no measurable effect on the current-voltage relationship.

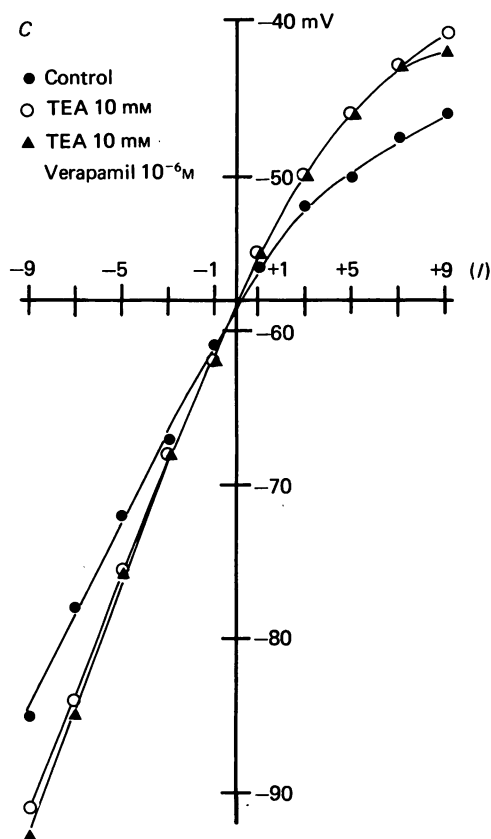

Fig. 6. C, current-voltage relationships of the rabbit main pulmonary artery. All three curves were obtained from the same cell in the sequence control, TEA 10 mM and TEA 10 mM + verapamil 10^{-6} M. The membrane potential was -58 mV under control conditions and -50 mV in the presence of 10 mM-TEA. The membrane potential did not change after addition of verapamil to the TEA-containing solution. The low membrane potential in the presence of TEA or TEA + verapamil was returned to the control value by current injection through the external electrodes before the current pulses for measurement of membrane properties were applied. This distance between the external stimulating electrode and the intracellular micro-electrode was 1.3 mm. In this particular cell outward current pulses did not elicit action potentials in the presence of TEA. Abscissa, intensity of externally applied current (arbitrary units). Ordinate, intracellularly recorded membrane potential (mV).

Within the first 30 min after commencement of exposure of the vascular strips to TEA, only a limited number of cells responded to outward current pulses with spikes (Fig. 7). Among 128 cells at a distance between 0.8 and 1.2 mm from the stimulating electrode, twelve (9.4%) produced action potentials in the presence of 10 mM-TEA at the highest current strength employed (90 μ A). The corresponding figures for

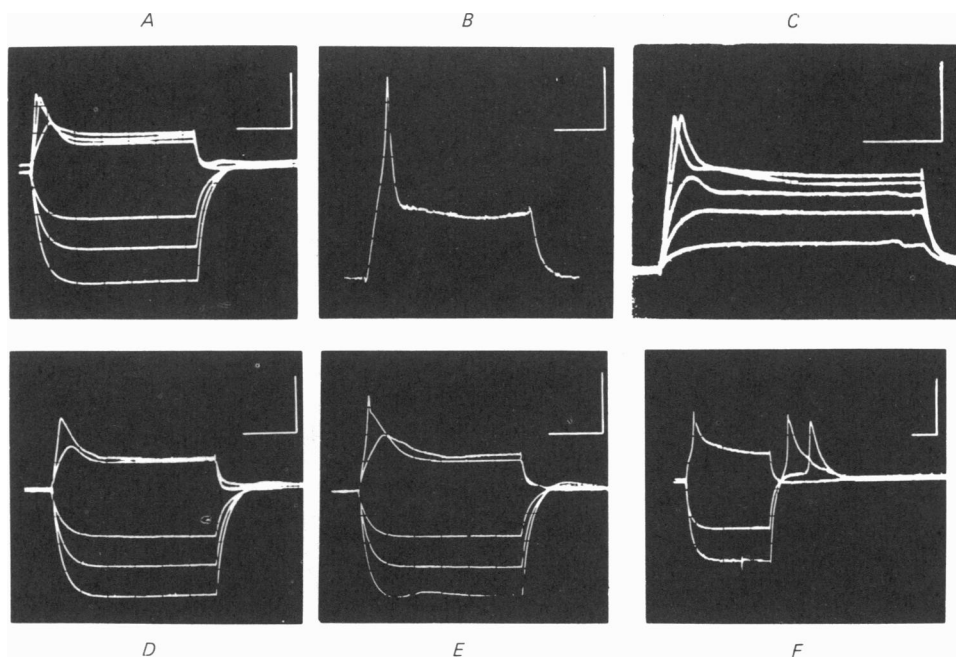

Fig. 7. Various examples of the occurrence of action potentials in response to outward current pulses after exposure of strips of rabbit main pulmonary artery to TEA 10 mM (A-C) or TEA 30 mM (D-F). All recordings were made within 30 min after commencement of perfusion with TEA-containing solution. Part F shows action potentials after break of anodal current application in addition to the action potential produced by a depolarizing current pulse. Membrane potentials for A-F were -51, -48, -49, -43, -40 and -42 mV, respectively. Calibrations are 30 mV (vertical and 1 sec (horizontal)).

30 mM-TEA under otherwise identical experimental conditions were thirteen out of sixty-six cells (19.7%). The action potentials were of variable duration (180-1000 msec) and amplitude but never showed an overshoot (Fig. 7). During the recording from seven cells with induced spikes (five cells for 10 mM-TEA and two cells for 30 mM-TEA) verapamil 10^{-7} M was added to the TEA-containing solution. In all cases the spikes disappeared within 3 min. Nickel chloride (10^{-3} M) had the same effect (eight cells, 10 mM-TEA), but tetrodotoxin (10^{-7} and 10^{-6} M) was inactive (eleven cells in 10 mM-TEA).

During incubation for the first 30 min in TEA-containing solution (10 and 30 mM) the vascular strips never showed spontaneous contractions and only in two cases in response to externally applied current pulses (TEA 30 mM). However, after prolonged incubation (> 30 min) of the vascular strips in TEA-containing solution

(10 or 30 mM) such contractions appeared. Superimposed on the TEA-induced, slight tonic contraction the strips developed spontaneous phasic contractions with a duration of several minutes (Fig. 8). The latter were observed more often in 30 mM-TEA than in 10 mM-TEA. Their frequency was particularly high after incubation of the strips for more than 90 min in a TEA-containing solution and under the condition of an elevated calcium concentration (Fig. 8). An increase of the calcium

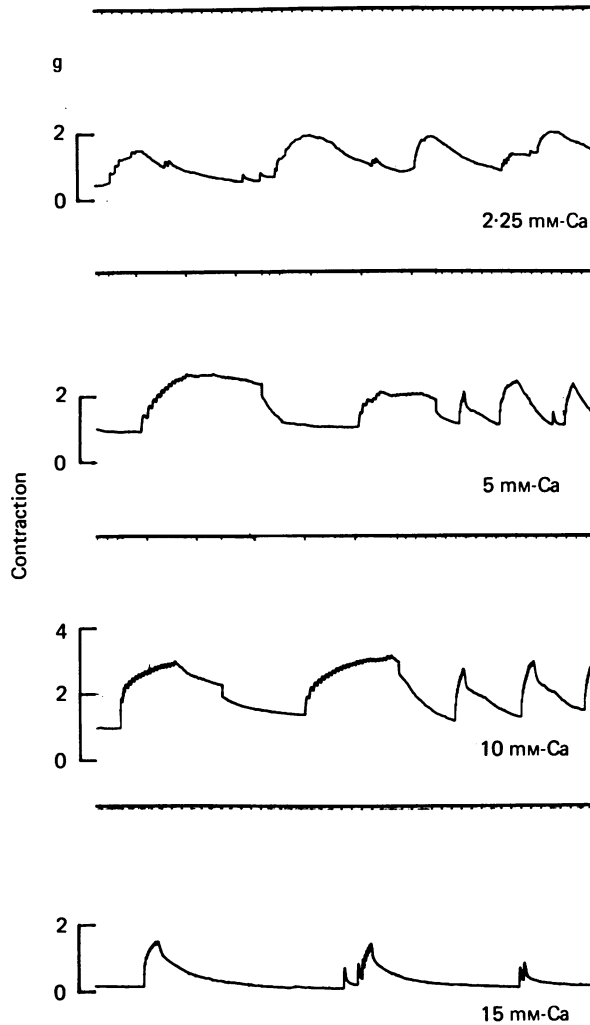

Fig. 8. Four examples of spontaneous phasic contractions occurring in strips of rabbit main pulmonary artery during prolonged exposure to 30 mM-TEA at four different calcium concentrations indicated in the Figure. The records were taken 120 min after commencement of perfusion with TEA-containing solution. The speed of the recording paper was transiently increased in the recordings obtained in the presence of 5 and 10 mM-calcium in order to demonstrate small and rapid phasic contractions superimposed on prolonged phasic contractions with a duration of several minutes. Elevation of the base line about 0 g indicates the extent of TEA-induced tonic contraction which appeared within 2-3 min after exposure to TEA. The time calibration at the top of the recordings is 1 min.

concentration from 2.25 to 5, 7.5 and 10 mM not only raised the frequency but also the amplitude of the phasic contractions (Fig. 8). Further increase in the calcium concentration to 15 mM reduced both the frequency and the height of the phasic contractions (Fig. 8). In contrast to a short exposure of the vascular strips to TEA, depolarizing current pulses, even of low strength, regularly elicited powerful phasic and synchronized contractions when the incubation time in TEA-containing solution was longer than 40–60 min. Since the intracellular micro-electrode was always dislodged by these contractions, no information is available about the configuration and frequency of induced action potentials or on the reduction of the rectifying property of the cell membrane under these conditions. However, it appears likely that during prolonged exposure to TEA small depolarizing current pulses were sufficient to evoke action potentials. The phasic contractions occurring either spontaneously or after break of hyperpolarizing current pulses led regularly to the dislodgement of the intracellular micro-electrode and made a reliable estimate of the space constant λ impossible. However, we had the impression that after prolonged (90–150 min) exposure to 30 mM-TEA, λ was larger than during short exposure (up to 30 min) to the same concentration of TEA. Phasic contractions occurring either spontaneously or in response to current pulses were abolished by addition of verapamil (10^{-6} M) to the bath fluid. Similar to the rapidly occurring effects of TEA the phasic contractions disappeared within 10–15 min after omission of TEA from the bath fluid.

The development of spontaneous and synchronized contractions in response to TEA (10 and 30 mM) appears to require time (30 min or more) and may be related to the formation of new gap junctions (Kannan & Daniel, 1978), a process which seems to be also time-dependent. In order to obtain electrophysiological evidence for the appearance of gap junctions, an attempt was made to determine the TEA-induced changes of both membrane resistance and core resistance. The latter represents the sum of the resistances of intracellular fluid and low-resistance pathways between cells, among them gap junctions. Since circularly cut strips of rabbit main pulmonary artery possess cable-like properties (Casteels *et al.* 1977*a*; present results), the equations of one dimensional cable theory (Hodgkin & Rushton, 1946) can be used to determine membrane resistance (r_m) and core resistance (r_i). In the steady state,

$$\frac{V(x)}{I_0} = R(x) = \frac{1}{2} \sqrt{r_m r_i} e^{-x/\sqrt{r_m/r_i}} = R_0 e^{-x/\lambda}$$

As suggested by Gage & Eisenberg (1969), r_m and r_i can be derived from measurements of the space constant (λ) and the input resistance (R_0):

$$r_m = 2[\sqrt{r_m/r_i}] \left[\frac{1}{2} \sqrt{r_m r_i} \right] = 2\lambda R_0$$

$$r_i = 2 \left[\frac{\frac{1}{2} \sqrt{r_m r_i}}{\sqrt{r_m/r_i}} \right] = \frac{2R_0}{\lambda}$$

In our partition chamber apparatus, an unknown but large part of the applied current passed through the extracellular space and the physiological saline solution surrounding the strip (see Methods), therefore, only relative values for R_0 could be obtained. Since, however, the specific resistances of this solution and of that containing

10 mM or 30 mM-TEA were virtually identical, it was possible to determine changes of r_m or r_i in response to TEA.

The effects of 10 and 30 mM-TEA on λ are given in Table 1. From the results of these experiments λ and R_0 were known and r_m and r_i could be calculated (Table 1). While TEA caused a concentration-dependent increase in r_m , the effects of TEA on λ and r_i appeared to be unrelated to concentration (Table 1). However, the sampling of electrotonic potentials at 10 mM-TEA was carried out between 20 and 60 min after administration of TEA and that at 30 mM between 5 and 30 min. Since the formation of gap junctions and hence changes in λ and r_i appear to be time-dependent processes, the absence of a concentration dependency (λ , r_i) may be explained by the different experimental conditions. The results provide an electrophysiological basis for the possibility that gap junctions are formed under the influence of TEA in the rabbit main pulmonary artery.

TABLE 1. The effects of TEA (10 and 30 mM) on the space constant (λ), the membrane resistance (r_m) and the core resistance (r_i) of the rabbit main pulmonary artery. The values for r_m and r_i are given in arbitrary units (see text for explanation). The results were obtained in five vascular strips in which TEA 10 and 30 mM were studied consecutively with a 2 hr wash-out period between the exposures to TEA. Shown are the mean values \pm s.e.

	Space constant (mm)	Membrane resistance (arbitrary units)	Core resistance (arbitrary units)
Controls	1.86 ± 0.07	210 ± 18.8	63 ± 10.4
TEA 10 mM	$3.44 \pm 0.04^{a,c}$	400 ± 57.2^b	34 ± 4.5^b
TEA 30 mM	3.12 ± 0.06^a	454 ± 30.1^a	47 ± 4.2

^a Significantly different from controls $2P < 0.001$

^b Significantly different from controls $2P < 0.05$

^c Significantly different from TEA 30 mM $2P < 0.05$

Paired *t* test

Influence of TEA on the effect of high potassium. In the presence of 10 mM-TEA the concentration-response curve for the contractions elicited by potassium was shifted to the left at low and intermediate potassium concentrations (Fig. 9A). However, TEA had no influence on the maximum contraction in response to potassium (Fig. 9A). A successful simultaneous record of contraction and membrane potential during consecutive exposure of a vascular strip to 10 mM-TEA and 30 mM-potassium in the presence of TEA is shown in Fig. 10.

In the concentration range between 20 and 100 mM-potassium the decrease in membrane potentials was linearly related to the log of the potassium concentration with a slope of 50 mV for a tenfold change in potassium concentration (Fig. 9B). Under the influence of 10 mM-TEA this relationship remained linear, however, the slope was decreased to 33 mV (Fig. 9B). The threshold concentration of potassium required for a discernible contraction of the strips was 15 mM (Fig. 9A). At this concentration the membrane potential was -45.3 ± 1.6 mV (Fig. 9B). The corresponding concentration of TEA was 10 mM or somewhat lower and the membrane potential -51.1 ± 1.2 mV (Fig. 4).

Influence of TEA on the effect of noradrenaline. In the presence of 10 mM-TEA the vascular strips were more sensitive to the contractile effect of noradrenaline than under control conditions resulting in a shift to the left of the noradrenaline concen-

tration-response curve (Fig. 11A). Furthermore, the maximum contraction in response to noradrenaline was significantly augmented by TEA (Fig. 11A). After a 30 min incubation of the strips in calcium-free solution the magnitude of the noradrenaline-induced contractions was markedly reduced and under this condition TEA had entirely lost its potentiating effect (Fig. 11A).

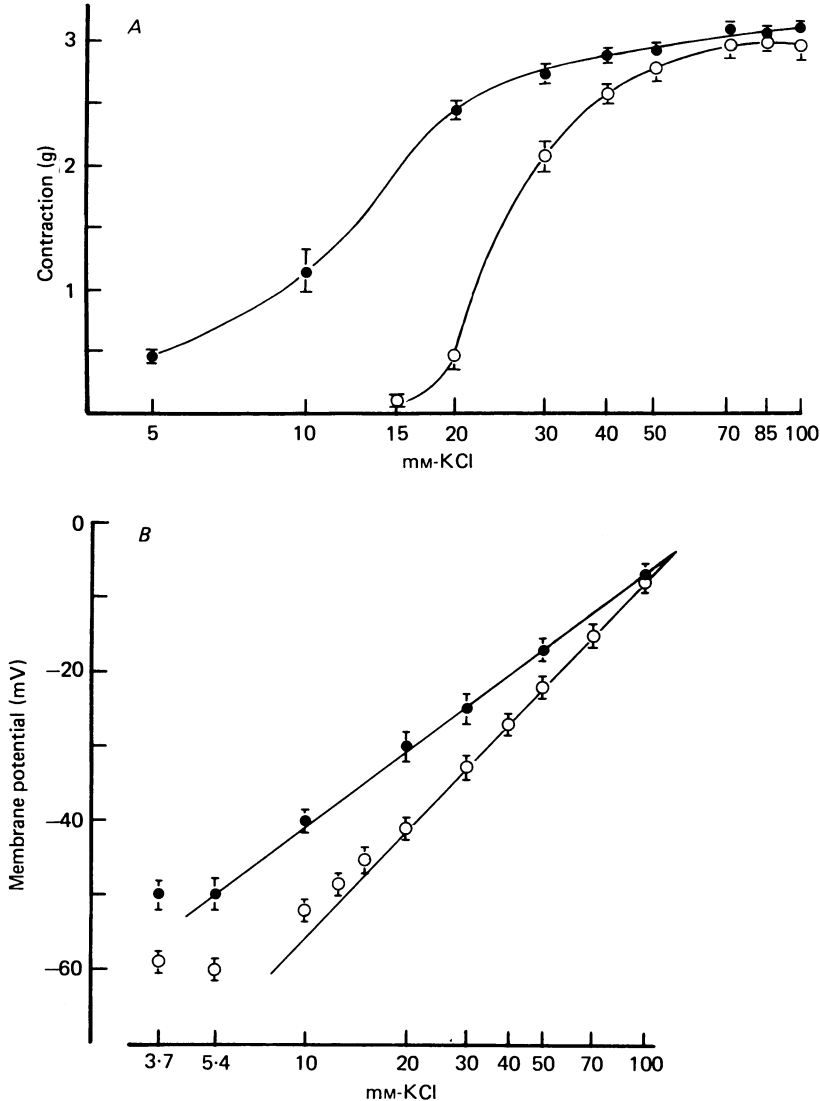

Fig. 9. *A*, concentration-response curve for the contractile effect of potassium in the absence (open circles, $n = 10$) and in the presence of 10 mM-TEA (filled circles, $n = 10$) obtained in strips of rabbit main pulmonary artery. Shown are the mean values (\pm s.e. as vertical bars).

B, relationship between the concentration of potassium in the bath fluid and the membrane potential of the vascular smooth muscle cells of the rabbit main pulmonary artery in the absence (open circles, forty impalements for each potassium concentration) and the presence of 10 mM-TEA (filled circles, twenty impalements for each potassium concentration). Shown are the mean values (\pm s.e. as vertical bars).

At concentrations between 10^{-8} and 10^{-6} M noradrenaline produced concentration dependent depolarizations resulting in a gradual decrease of the membrane potential from approximately -60 to -45 mV (Fig. 11B). Above the concentration of 10^{-6} M noradrenaline no further depolarization was observed (Fig. 11B). TEA 10 mM caused a remarkable change of this concentration-response relationship. As expected, TEA reduced the membrane potential of the vascular smooth muscle cells to -49.5 ± 1.6 mV and starting from this value noradrenaline produced depolarizations throughout the concentration range tested (up to 10^{-4} M) (Fig. 11B). With the highest concentration of noradrenaline (10^{-4} M) the membrane potential was reduced to -26.8 ± 2.1 mV, a value never observed with noradrenaline in the absence of TEA (Fig. 11B).

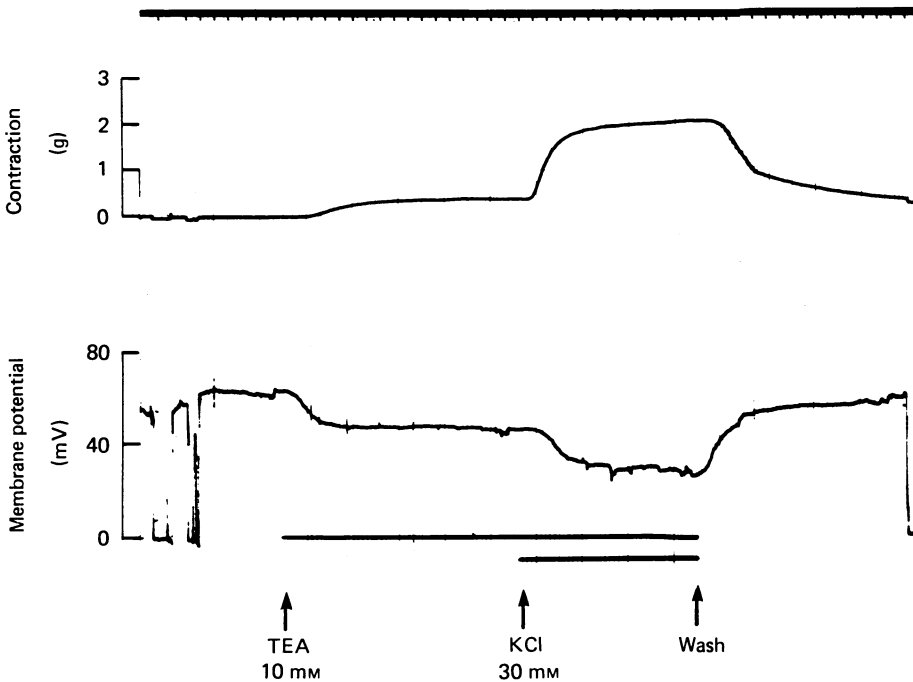

Fig. 10. Simultaneous recording of contractile state and membrane potential in a strip of rabbit main pulmonary artery exposed to 10 mM-TEA and subsequently to 30 mM-potassium in the presence of 10 mM-TEA. The time calibration at the top of the recordings is 1 min.

Part of our findings differs from those of Casteels, Kitamura, Kuriyama & Suzuki (1977b). These authors found that at noradrenaline concentrations lower than 2.5×10^{-7} M contraction occurred without depolarization. In our hands depolarization was reproducibly induced by noradrenaline in concentrations as low as 10^{-8} M. We were able to record in a few cells both membrane potential and contraction throughout a complete contraction-relaxation cycle without dislodgement of the intracellular micro-electrode by the weak contraction in response to such low concentrations of noradrenaline.

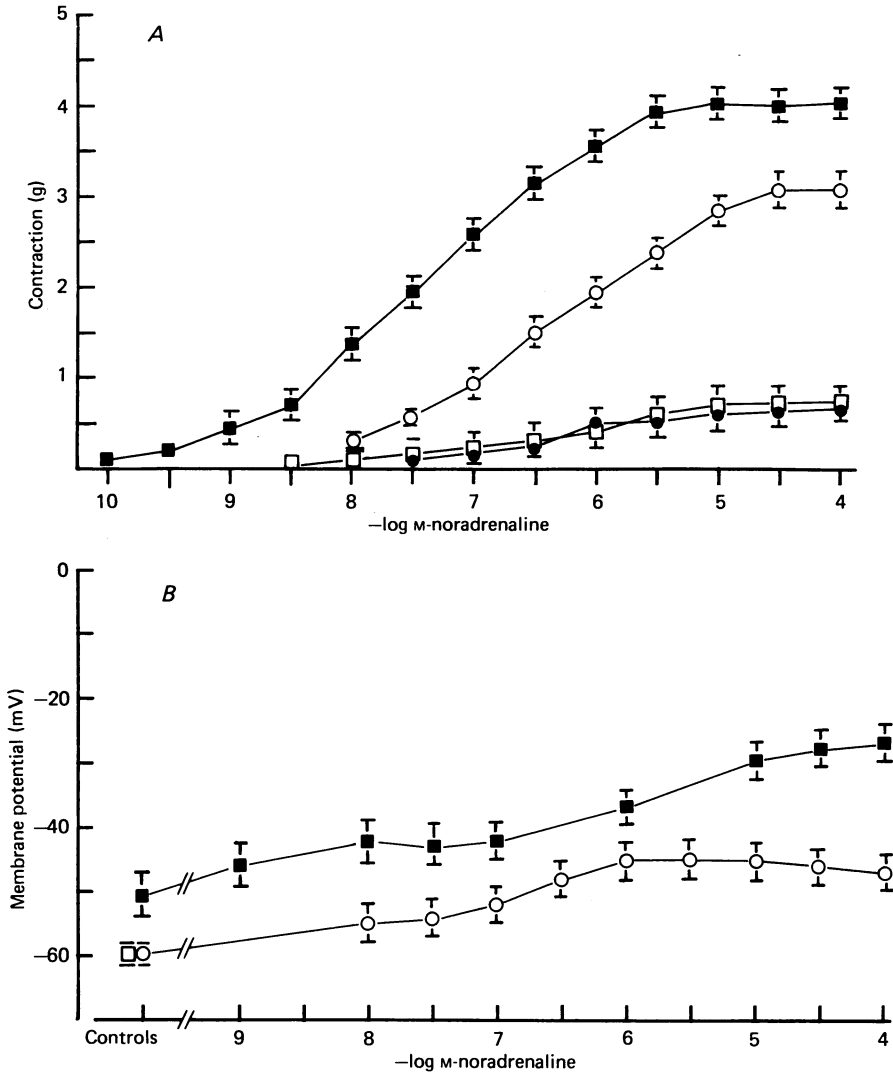

Fig. 11. *A*, concentration-response curves for the contractile effect of noradrenaline in the absence (open circles, $n = 10$) and in the presence of 10 mM-TEA (filled squares, $n = 10$) obtained in strips of rabbit main pulmonary artery. Incubation of the vascular strips for 30 min in calcium-free solution resulted in contractions of similar magnitude in response to noradrenaline both in the absence (filled circles, $n = 10$) and the presence of 10 mM-TEA (open squares, $n = 10$). Shown are the mean values (\pm s.e. as vertical bars).

B, Relationship between the concentration of noradrenaline in the bath fluid and the membrane potential of the vascular smooth muscle cells of the rabbit main pulmonary artery in the absence (open circles, at least fifty impalements for each concentration of noradrenaline) and in the presence of 10 mM-TEA (filled squares, at least thirty impalements for each concentration of noradrenaline). Controls, open square means the sum of the impalements belonging to the strips which had subsequently been exposed to TEA. Controls, filled square indicates exposure to TEA in the absence of noradrenaline. Shown are the mean values (\pm s.e. as vertical bars).

DISCUSSION

The effects of TEA on the vascular smooth muscle cells of the rabbit pulmonary artery can be divided into two types depending on the rapidity of onset. Depolarization, increase in membrane resistance, inhibition of rectification and contraction occur within 2–3 min after exposure to TEA while the induction of phasic contractions requires 30–90 min for its full development. Among the effects with rapid onset, depolarization, increase in membrane resistance and inhibition of rectification are best explained by a TEA-induced blockade of potassium channels. The reduction by TEA of the slope of the relationship between log potassium concentration and decrease in membrane potential is interpreted in the same way. Obviously TEA affects potassium channels in the smooth muscle cells of the rabbit main pulmonary artery (see also Casteels *et al.* 1977*b*) as it does in a variety of tissues (Hille, 1967; Koppenhöfer, 1967; Armstrong, 1969, 1971; Stanfield, 1970; Ito *et al.* 1970; Ochi & Nishiye, 1974).

In spite of a similar dependence of the contractions on extracellular calcium, several findings of the present study indicate for TEA and potassium a different relationship between membrane potential and contraction. (1) The concentration of TEA to evoke threshold contractions was 10 mM or slightly lower, that of potassium 15 mM. At these concentrations the membrane potential of the vascular smooth muscle cells is -51 and -45 mV, respectively. (2) For a concentration of 30 mM TEA, membrane potential and contraction were -44 mV and 0.7 g, respectively, for 20 mM-potassium the corresponding values were -42 mV and 0.4 g. Apparently threshold contractions appear under TEA with less depolarization than under potassium and for comparable depolarizations the contractions are higher in response to TEA. (3) Potassium at a concentration of 20 mM and the combination of TEA (10 mM) and potassium (10 mM) reduce the membrane potential to a similar extent, namely to approximately -40 mV. However, the means of the contractions are 0.4 and 1.1 g, respectively (compare Fig 9*A* and *B*). (4) The concentration–response curve of TEA for contraction starts to become steeper at 30 mM-TEA or in terms of membrane potential at a value of -44 mV. The latter is in good agreement with the membrane potential at which a threshold contraction occurs in response to potassium (compare Figs. 4, 9*A* and *B*). A possible explanation for these observations rests on the assumption that at low concentrations of TEA (up to 30 mM) the contractions are independent of the membrane potential and produced by an increase in calcium conductance of the membrane. Whether the latter action indicates an additional pharmacological property of TEA distinct from its well known effect on potassium channels or whether a TEA-induced blockade of potassium channels opens neighbouring calcium channels cannot be decided. One may speculate that at concentrations of TEA above 30 mM, i.e. when the membrane potential is lower than -45 mV, an additional voltage-dependent increase in calcium conductance enhances contraction and is responsible for the change in the slope of the curve relating concentration of TEA to contraction (Fig. 4).

Under the influence of TEA the current–voltage relationship was steeper than under control conditions dependent upon the concentration of TEA (10 and 30 mM) and the space constant increased. Furthermore, rectification of the membrane was

inhibited. These findings are all compatible with a partial blockade of potassium channels by TEA and a resulting increase in membrane resistance. Further support for an increase in calcium conductance by TEA is provided by the following finding: verapamil and nickel chloride increased slightly the amplitude of the electrotonic potentials in strips already exposed to TEA but not in control strips. The concentration of verapamil (10^{-6} M) was the same which substantially reduced the contractile responses to TEA (Fig. 1). There is apparently a TEA-induced increase in calcium conductance which is sensitive to verapamil and nickel chloride.

During a short exposure to TEA only part of the vascular smooth muscle cells responded to depolarizing current pulses with spike potentials. The percentage of spike generating cells was greater when the concentration of TEA was raised from 10 to 30 mM. Normally, these may be latent pace-maker cells. The spike potentials were extremely sensitive to inhibition by verapamil and nickel chloride but were not affected by tetrodotoxin. In the case of verapamil the very low concentration of 10^{-7} M was sufficient to abolish spikes. It seems, therefore, that the inward current of the spike potentials is carried by calcium ions. The induction by TEA of prolonged action potentials with a large calcium-dependent component has been reported by Kleinhaus & Prichard (1975) for Retzius cells of leech segmental ganglia.

Prolongation of the exposure of the vascular strips to TEA resulted in the following events which were fully developed 90–120 min after start of the perfusion with TEA. (1) The number of cells responding to depolarizing current pulses with spike potentials increased gradually and the required current strength to elicit spikes decreased. (2) There was a progressive increase in the frequency with which depolarizing current pulses produced phasic contractions of the vascular strips until every current pulse, even inwardly directed (due to the formation of anodal break potentials), was followed by powerful, synchronized contractions. (3) Phasic contractions appeared also in the absence of external stimuli. All events were abolished by verapamil 10^{-6} M. Apparently time-dependent processes were responsible for these slowly developing effects of TEA. One of such processes may be the formation of new gap junctions. On the basis of an electronmicroscopic evaluation Kannan & Daniel (1978) reported that in canine tracheal smooth muscle TEA (3 and 10 mM) increased the number of gap junctions during a 1 hr *in vitro* incubation in Krebs solution at 37 °C by approximately 60%. Our present finding of a decrease in core resistance under the influence of TEA may provide the first electrophysiological evidence for such an effect of TEA.

Another possibility to explain the slow development of part of the actions of TEA is penetration of TEA across the cell membrane with a resultant slow increase in intracellular TEA concentration. Depending upon the type of tissue, TEA affects potassium conductance by either an action on the inside of the cell membrane, for instance squid axon (Armstrong, 1969) or guinea-pig papillary muscle (Ochi & Nishiye, 1974), or on both sides of the membrane: frog node of Ranvier (Hille, 1967; Koppenhöfer, 1967); frog skeletal muscle (Stanfield, 1970); snail neurones (Neher & Lux, 1972); Retzius cells of leech segmental ganglia (Kleinhaus & Prichard, 1975). Recently Herman & Gorman (1978) reported that under voltage-clamp conditions extracellular TEA antagonized more effectively than intracellular TEA a potassium outward current which was induced by calcium ions injected ionophoretically into

the soma of *Aplysia* R15 neurones. Both extracellular and intracellular TEA blocked a voltage-dependent potassium current. If the same were true for the smooth muscle cells of the rabbit main pulmonary artery, the effect of TEA on the latter type of potassium current may become more prominent with increasing intracellular TEA concentration. However, the effects which are typical for a prolonged exposure to TEA disappeared rapidly in our experiments after removal of TEA from the bath fluid and make a contribution from intracellular accumulation of TEA unlikely.

TEA has a remarkable effect on the electrical and mechanical responses of the pulmonary artery to noradrenaline. In the absence of TEA noradrenaline causes a concentration-dependent depolarization in the range between 10^{-8} and 10^{-6} M with a progressive decrease in membrane potential from -60 mV to -45 mV. Above the concentration of 10^{-6} M no further depolarization was found. Since the maximum contraction occurs at 3×10^{-5} M noradrenaline, part of the mechanical response takes place in the absence of changes of the membrane potential. In the presence of 10 mM-TEA noradrenaline depolarized the membrane at all concentrations employed (up to 10^{-4} M) and reduced the membrane potential to very low levels (to -27 mV with 10^{-4} M-noradrenaline). This depolarization is greater by 18 mV than the maximal depolarization found with noradrenaline under control conditions. Concomitantly contractions occurred at lower concentrations of noradrenaline and the maximal contractions were significantly higher. In the concentration range between 10^{-5} and 10^{-4} M noradrenaline produced in the presence of 10 mM-TEA depolarizations without further contraction.

These findings may have a general meaning for the understanding of excitation-contraction coupling of non-spiking vascular smooth muscle. The increase in intracellular calcium during noradrenaline-induced contraction will gradually raise (depending on the internal calcium concentration) the potassium conductance. A direct positive relationship between increasing internal calcium and an elevation of potassium permeability has been demonstrated in various tissues (human erythrocytes, Romero & Whittam, 1971, Porzig, 1975; snail neurones, Meech & Standen, 1975; spinal motoneurones, Krnjević & Lisiewicz, 1975; mammalian cardiac muscle, Bassingthwaighe, Fry & McGuigan, 1976; mouse pancreatic β -cells, Atwater, Dawson, Ribalet & Rojas, 1979). If this holds also true for vascular smooth muscle, the calcium-induced increase in potassium conductance will progressively counteract the depolarization in response to noradrenaline to a point where a further increase in the concentration of noradrenaline is no longer followed by a decrease in membrane potential. Blockade of potassium channels by TEA will prevent the counterregulation and unmask depolarization even at high concentrations of noradrenaline. That TEA is principally able to antagonize calcium-induced increases in potassium current has been shown in voltage-clamp experiments on *Aplysia* neurones (Herman & Gorman, 1978). Since the maximum contraction to noradrenaline is greater in the presence of TEA than under control conditions, it appears that normally the calcium-induced increase in potassium conductance with the resulting effect on the membrane potential restricts the influx of calcium ions into the smooth muscle cells and thereby limits the mechanical response to maximal or near maximal stimulation of α -adrenoceptors by noradrenaline. This restriction which may be considered as a protective mechanism against overstimulation is eliminated by blockade of potassium channels with TEA.

G. H. thanks Drs A. V. Somlyo and A. P. Somlyo for teaching him the technique of intracellular recording from smooth muscle cells. We are grateful to Drs A. P. Somlyo, H. Reuter and W. Häefely for critical reading of the manuscript and many valuable suggestions, to Miss W. Kröger and Mr Ch. Reck for skilful technical assistance.

REFERENCES

- ABE, Y. & TOMITA, T. (1968). Cable properties of smooth muscle. *J. Physiol.* **196**, 87–100.
- ARMSTRONG, C. M. (1969). Inactivation of the potassium conductance and related phenomena caused by quaternary ammonium ion injection in squid axons. *J. gen. Physiol.* **54**, 553–575.
- ARMSTRONG, C. M. (1971). Interaction of tetraethylammonium ion derivatives with the potassium channels of giant axons. *J. gen. Physiol.* **58**, 413–437.
- ARMSTRONG, C. M. & BINSTOCK, L. (1965). Anomalous rectification in the squid giant axon injected with tetraethylammonium chloride. *J. gen. Physiol.* **48**, 589–872.
- ATWATER, I., DAWSON, C. M., RIBALET, B. & ROJAS, E. (1979). Potassium permeability activated by intracellular calcium ion concentration in the pancreatic β -cell. *J. Physiol.* **288**, 575–588.
- BASSINGTHWAIGHTE, J. B., FRY, C. H. & MCGUIGAN, J. A. S. (1976). Relationship between internal calcium and outward current in mammalian ventricular muscle; a mechanism for the control of action potential duration. *J. Physiol.* **262**, 15–37.
- BEVAN, J. A. (1963). Action of tetraethylammonium chloride on the sympathetic ganglia-pulmonary artery preparation. *J. Pharmac. exp. Ther.* **140**, 193–198.
- CASTEELS, R., KITAMURA, K., KURIYAMA, H. & SUZUKI, H. (1977*a*). The membrane properties of the smooth muscle cells of the rabbit main pulmonary artery. *J. Physiol.* **271**, 41–61.
- CASTEELS, R., KITAMURA, K., KURIYAMA, H. & SUZUKI, H. (1977*b*). Excitation-contraction coupling in the smooth muscle cells of the rabbit main pulmonary artery. *J. Physiol.* **271**, 63–79.
- CHOI, Y. S. & DI PALMA, J. R. (1973). Studies on the interaction of norepinephrine with some other drugs on the aortic smooth muscle of the rabbit. *Archs. int. Pharmacodyn. Théor.* **205**, 11–22.
- CREED, K. E., GILLESPIE, J. S. & MUTR, T. C. (1975). The electrical basis of excitation and inhibition in the rat anococcygeus muscle. *J. Physiol.* **245**, 33–47.
- GAGE, P. W. & EISENBERG, R. S. (1969). Capacitance of the surface and transverse tubular membrane of frog sartorius muscle fibres. *J. gen. Physiol.* **53**, 265–278.
- HAEUSLER, G. (1972*a*). Differential effect of verapamil on excitation-contraction coupling in smooth muscle and on excitation-secretion coupling in adrenergic nerve terminals. *J. Pharmac. exp. Ther.* **180**, 672–682.
- HAEUSLER, G. (1972*b*). Membrane potential and contraction in vascular smooth muscle. *Experientia* **28**, 742–743.
- HAEUSLER, G. (1978). Relationship between noradrenaline-induced depolarization and contraction in vascular smooth muscle. *Blood Vessels* **15**, 46–54.
- HAEUSLER, G., KUHN, H. & THORENS, S. (1980). The effect of tetraethylammonium chloride on calcium fluxes in vascular smooth muscle from rabbit main pulmonary artery. *J. Physiol.* **303**, 225–241.
- HERMAN, A. & GORMAN, A. L. F. (1978). Blockage of the Ca^{2+} induced K^{+} current by TEA in molluscan bursting pacemaker neurons. *Biophys. J.* **21**, 52*a*.
- HILLE, B. (1967). The selective inhibition of delayed potassium currents in nerve by tetraethylammonium ion. *J. gen. Physiol.* **50**, 1287–1302.
- HODGKIN, A. L. & RUSHTON, W. A. H. (1946). The electrical constants of a crustacean nerve fibre. *Proc. R. Soc. B* **133**, 444–479.
- ITO, Y., KURIYAMA, H. & SAKAMOTO, Y. (1970). Effects of tetraethylammonium chloride on the membrane activity of guinea-pig stomach muscle. *J. Physiol.* **211**, 445–460.
- KALSNER, S. (1973). Mechanism of potentiation of vascular responses by tetraethylammonium: a novel form of sensitization. *Can. J. Physiol. Pharmac.* **51**, 451–457.
- KANNAN, M. S. & DANIEL, E. E. (1978). Formation of gap junctions by treatments in vitro with potassium conductance blockers. *J. cell. Biol.* **78**, 338–348.
- KAO, C. Y. & STANFIELD, P. R. (1970). Actions of some cations on the electrical properties and mechanical threshold of frog sartorius muscle fibres. *J. gen. Physiol.* **55**, 620–639.

- KELKAR, V. V., GULATI, O. D. & GOKHALE, S. D. (1964). Effect of ganglion blocking drugs on the responses of the rabbit aortic strip to adrenaline, noradrenaline and other vaso-active substances. *Archs int. Pharmacodyn. Thér.* **149**, 209–222.
- KIRKPATRICK, C. T. (1975). Excitation and contraction in bovine tracheal smooth muscle. *J. Physiol.* **244**, 263–281.
- KLEINHAUS, A. L. & PRICHARD, J. W. (1975). Calcium dependent action potentials produced in leech Retzius cells by tetraethylammonium chloride. *J. Physiol.* **246**, 351–361.
- KOPPENHÖFER, E. (1967). Die Wirkung von Tetraethylammoniumchlorid auf die Membranströme Ranvierscher Schnürringe von *Xenopus laevis*. *Pflügers Arch. ges. Physiol.* **293**, 34–55.
- KRNJEVIĆ, K. & LISIEWICZ, A. (1975). Injection of calcium ions into spinal moto-neurones. *J. Physiol.* **251**, 549–559.
- KROEGER, E. A. & STEPHENS, N. L. (1975). Effect of tetraethylammonium on tonic airway smooth muscle: initiation of phasic electrical activity. *Am. J. Physiol.* **228**, 633–636.
- LUM, B. K. B. & RASHLEIGH, P. L. (1961). Potentiation of vaso-active drugs by ganglionic blocking agents. *J. Pharmac. exp. Ther.* **132**, 13–18.
- MEECH, R. D. & STANDEN, N. B. (1975). Potassium activation in *Helix aspersa* neurones under voltage clamp: a component mediated by calcium influx. *J. Physiol.* **248**, 211–239.
- MEKATA, F. (1971). Electrophysiological studies of the smooth muscle cell membrane of the rabbit common carotid artery. *J. gen. Physiol.* **57**, 738–751.
- NEHER, E. & LUX, H. D. (1972). Differential action of TEA⁺ on two K⁺-current components of a molluscan neurone. *Pflügers Arch.* **336**, 87–100.
- OCHI, R. & NISHIYE, H. (1974). Effect of intracellular tetraethylammonium ion on action potential in the guinea-pig's myocardium. *Pflügers Arch.* **348**, 305–316.
- OSA, T. & KURIYAMA, H. (1970). The membrane properties and decremental conduction of excitation in the fundus of the guinea-pig stomach. *Jap. J. Physiol.* **20**, 626–639.
- PORZIG, H. (1975). Comparative study of the effects of propranolol and tetracaine on cation movements in resealed human red cell ghosts. *J. Physiol.* **249**, 27–49.
- REUTER, H., BLAUSTEIN, M. P. & HAEUSLER, G. (1973). Na–Ca exchange and tension development in arterial smooth muscle. *Phil. Trans. R. Soc. B* **265**, 87–94.
- ROMERO, P. J. & WHITTAM, R. (1971). The control by internal calcium of membrane permeability of sodium and potassium. *J. Physiol.* **214**, 481–507.
- SANDOW, A. (1970). Skeletal muscle. *A. Rev. Physiol.* **32**, 87–138.
- SOMLYO, A. V. & SOMLYO, A. P. (1968). Electromechanical and pharmacomechanical coupling in vascular smooth muscle. *J. Pharmac. exp. Ther.* **159**, 129–145.
- SOMLYO, A. V., VINALL, P. & SOMLYO, A. P. (1969). Excitation–contraction coupling and electrical events in two types of vascular smooth muscle. *Microvasc. Res.* **1**, 354–373.
- STANFIELD, P. R. (1970). The effect of the tetraethylammonium ion on the delayed currents of frog skeletal muscle. *J. Physiol.* **209**, 209–229.
- STANFIELD, P. R. (1973). The onset of the effects of zinc and tetraethylammonium ions on action potential duration and twitch amplitude of single muscle fibres. *J. Physiol.* **235**, 639–654.
- SUZUKI, T., NISHIYAMA, A. & INOMATA, H. (1963). Effect of tetraethylammonium ion on the electrical activity of smooth muscle cell. *Nature, Lond.* **197**, 908–909.
- SZURSZEWSKI, J. H. (1978). A study of the canine gastric action potential in the presence of tetraethylammonium chloride. *J. Physiol.* **277**, 91–102.
- THOENEN, H., HAEFELY, W. & STAEHELIN, H. (1967). Potentiation by tetraethylammonium of the response of the cat spleen to postganglionic sympathetic nerve stimulation. *J. Pharmac. exp. Ther.* **157**, 532–540.