

SITE AND MODE OF ADRENALINE ACTION ON CHLORIDE TRANSPORT ACROSS THE RABBIT CORNEAL EPITHELIUM

BY S. D. KLYCE AND R. K. S. WONG*

From the Division of Ophthalmology, Department of Surgery, Stanford University School of Medicine, Stanford, California 94305, U.S.A.

(Received 27 September 1976)

SUMMARY

1. Membrane events accompanying adrenaline-stimulated Cl secretion by the isolated rabbit corneal epithelium were investigated with micro-electrodes.

2. Pulses of adrenaline (5×10^{-10} M final concentration) delivered to either side of the epithelium produced a transient decrease in epithelial resistance occurring at the outer membrane of the squamous cell. This response was reversible and could be blocked completely by total Cl substitution with SO_4 .

3. Adrenaline generally produced a small transient increase in epithelial potential occurring also at the squamous cell outer membrane. Reversal potentials obtained for the adrenaline response were 45.1 mV for corneal potential and 22.8 mV for outer membrane.

4. Adrenaline always hyperpolarized epithelial potential when the tear side was bathed in Cl-free solution. Reversing the gradient (Cl-free on the stromal side) slowly and consistently changed the response to a depolarization which reached a steady level after 2 hr.

5. The reversal potential of the outer membrane for the adrenaline response was found to be a semilogarithmic function of the tear side Cl concentration over a broad range with a slope of 56 mV/decade. The reversal potential was zero at a tear side Cl concentration of 41.5 mM, which value may be taken to be representative of cell Cl concentration.

6. After abolishing the adrenaline response by perfusing both sides of the tissue with Cl-free solution, reintroduction of Cl to the stromal side led to a recovery of the epithelial potential response in the hyperpolarizing direction. The recovery of the response was inhibited by ouabain (10^{-5} M).

7. The results supported the following model for the influence of adrenaline on anion transport in the epithelium: Cl is transported against an

* Present address, Department of Neurology, Stanford University School of Medicine, Stanford, C4 94305, U.S.A.

electrochemical potential gradient into the cells from the stromal side by an active process linked to Na-K activated ATPase. Normally a slight gradient exists from cells to tears favouring the passive outward diffusion of Cl. This latter process is enhanced by adrenaline, which increases cell cyclic AMP, in turn increasing the passive Cl permeability of the outer cellular membrane.

INTRODUCTION

The stratified corneal epithelium of the rabbit generates a potential of 25–35 mV (tear side negative) *in vivo* (Maurice, 1967; Klyce, 1972*a*) as well as in the isolated preparation (Donn, Maurice & Mills, 1959; Ehlers & Ehlers, 1968; Klyce, 1972*a*; Klyce, Neufeld & Zadunaisky, 1973; Klyce, 1975). Epithelial resistance of a carefully mounted tissue varies from 3 to 8 k Ω cm² depending to a great extent on the degree of activation of its ion transport processes (Klyce *et al.* 1973; Klyce, 1975). This layer actively transports Na from the tears to the stroma (Donn *et al.* 1959; Green, 1965; Klyce, 1975) and Cl in the opposite direction (Klyce, 1972*b*; Klyce *et al.* 1973; Van der Heyden, Weekers & Schoffeniels, 1975; Klyce, 1975). Cl secretion by the epithelium is apparently mediated by cyclic AMP, since adrenaline, theophylline and dibutyryl cyclic AMP all stimulate this process (Klyce, 1972*b*; Klyce *et al.* 1973). Epithelial resistance was decreased more than 50% during stimulation of Cl transport, but epithelial potential was influenced only slightly. While it is generally recognized that the corneal endothelium can regulate stromal hydration by means of its fluid pump (Maurice, 1972), participation of the epithelium in this process must be considered as well, since recent experiments have demonstrated the ability of its Cl transport mechanism to thin the swollen stroma (Klyce, 1975).

In the present study the cellular mechanisms underlying Cl transport and its stimulation by adrenaline were examined using low doses of the hormone so that its characteristic effect on epithelial resistance could be repeatedly evoked in the same cornea. With this procedure and with micro-electrode techniques, it was found that adrenaline increased the Cl permeability of the outer membrane of the squamous cell. This rate limiting barrier in the transcellular transport of Cl was in series with a ouabain-sensitive active process located in the deeper epithelium.

METHODS

New Zealand White rabbits 3–4 kg in weight were killed either with an overdose of Na pentobarbitone or by standard abattoir procedure. Corneas were dissected from enucleated eyes and mounted in a lucite chamber (exposed surface was ≈ 1 cm²) designed for micro-electrode studies (Klyce, 1972*a*). As suggested by the

work of Lewis & Diamond (1975) with rabbit urinary bladder, the isolation procedure was modified to reduce edge damage effects by using a silicone grease seal (Dow Corning stopcock grease) around the perimeter of the epithelial hemichamber. Each corneal surface was perfused with Ringer fluid with the following composition: 103.4 mM-NaCl, 15.3 mM-Na₂SO₄, 10 mM-NaHCO₃, 2.2 mM-K₂HPO₄, 0.5 mM-KH₂PO₄, 5.24 mM-H₃PO₄, 0.61 mM-MgSO₄, 0.7 mM Ca gluconate, 26 mM glucose, and 20 mM Tris (hydroxymethylaminomethane). All solutions had a final osmolarity of 305 m-osmole and a pH of 7.4. Experiments were performed at 35° C, and the solutions were aerated. Alterations in the Cl content of the bathing solutions were achieved with SO₄ substitution.

When ouabain (strophanthin-G; Sigma Chemical Co.) was used, it was added to the stromal bathing solution. In experiments involving additions or substitutions on the stromal side, the endothelium was removed as previously described (Klyce, 1975) to allow more rapid penetration to the basal epithelium. Adrenaline (L-epinephrine bitartrate; Sigma Chemical Co.) was diluted in distilled water immediately before use. Pulses of adrenaline (10⁻⁷ M) of 2 μl. were delivered to 1 ml. of tear perfusate with a micropipette, resulting in a final effective dose of about 5 × 10⁻¹⁰ M.

Electrical measurements. Fig. 1 shows the general schematic for the simultaneous measurement of corneal membrane potentials and resistances in isolated preparations. Transepithelial potential was measured through agar-Ringer bridges and Ag/AgCl half-cells with a dual probe electrometer (Model 750, WP Instrument Inc., New Haven, CT). The micro-electrode potential was monitored with a second electrometer (Model M4A, WP Instrument Inc.) using its bridge balance circuit to monitor tip resistance. Micro-electrode potential was monitored with reference to the tear and stromal solutions by means of differential chart recorder preamplifiers. This enabled simultaneous recordings of corneal potential (V_{ts}), outer barrier potential (V_{to}) and inner barrier potential (V_{ta}). The preparation was grounded through a Ag/AgCl half-cell and associated low resistance agar bridge in contact with the stromal side of the preparation. A second current electrode (agar-Ringer/Ag/AgCl) was placed in contact with the tear side solution to apply currents across the cornea. Constant current pulses were obtained with an operational amplifier (type LM 301A) in a voltage-controlled current source configuration. The command to the current clamp was derived from a stimulator (Model S44B, Grass Instruments Co., Quincy, Mass). The current across the cornea was independently monitored with an electrometer sensing the voltage across a 1 kΩ resistor in series with the ground return of the current loop.

Micro-electrodes were pulled from microfibre capillary stock (Frederick Haer & Co., Ann Arbor, Mich.) with a horizontal automatic puller (Industrial Science Associates, Inc., Ridgewood, N.J.). They were filled immediately afterwards with 1 M-K-citrate using the method of Tasaki, Tsukahara, Ito, Wayner & Yu (1968). Resistances of 20–30 MΩ measured in Ringer solution were found to produce stable recordings. The tip potentials measured by tip breakage at experiment conclusions ranged from 2 to 8 mV. Results were discarded if the tip potential changed more than 2 mV or if the electrode resistance changed more than 5 MΩ after intracellular recording.

Most of the experiments were done with a micro-electrode situated deep in the intermediate cell layer (wing cells) from which continuous stable recordings could be obtained for up to 30 min, allowing several procedures to be carried out while recording from a single cell. The surface squamous cells, being only a few micra in thickness, were more difficult to impale for extended periods. In this study as well as in a previous report (Klyce, 1972a), squamous and wing cells were always isopotential even in the short-circuited cornea, indicating that they are well coupled.

Such coupling may be the result of the increase in number of desmosomes toward the outer half of the epithelium, as noted by Teng (1961). Therefore, the potential drop across the outer membrane of the squamous cell could be obtained by recording from a wing cell.

Transverse resistances were determined by applying 1 sec hyperpolarizing currents smaller than $10 \mu\text{A}/\text{cm}^2$ with the current bridges. Since it is known that the I - V relation for this epithelium is approximately linear for currents of this magnitude and polarity (Klyce, 1972*a*), resistances were calculated from Ohm's Law. When a micro-electrode is situated in a wing cell, the resistance measured between the micro-electrode tip and the tear side solution was defined as the outer barrier resistance, R_{tc} , and the resistance from the tip and the stromal bathing solution was defined as the inner barrier resistance, R_{cs} . Epithelial resistance, R_{ts} , is then the sum of R_{tc} and R_{cs} .

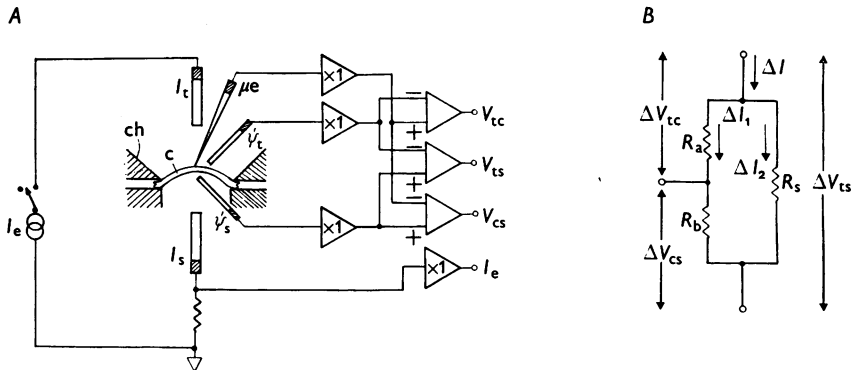

Fig. 1. Recording technique. *A*, schematic diagram of the recording system. Unity gain amplifiers are high impedance electrometers, while the differential amplifiers are chart recorder preamplifiers. Agar-Ringer bridges placed in the tear (ψ_t) and stromal (ψ_s) solutions bathing the cornea (*c*) mounted in a chamber (*ch*) together with a micro-electrode (μe) inserted in an epithelial cell enabled the simultaneous measurement of the potentials across the epithelium (V_{ts}), between the tear side and the cell (V_{tc}) and between the cell and the stromal side (V_{cs}). A current clamp (I_e) with associated bridges I_t and I_s was used in the resistance determinations and in the determination of reversal potentials. Reversible half-cells (cross-hatched) join the five electrolyte bridges to the electrical system. *B*, Thévenin equivalent of epithelium used for the analysis of the site of the adrenaline effect. R_a and R_b represent the resistance of the cellular pathway between the micro-electrode tip and each bathing solution. R_s represents the resistance of the paracellular pathway. Externally applied current (ΔI) traverses the epithelium via both the cellular (ΔI_1) and paracellular (ΔI_2) pathways and produces voltage deflexions ΔV_{ts} , ΔV_{tc} and ΔV_{cs} used to measure R_{ts} , R_{tc} , and R_{cs} , respectively.

The simplest Thévenin equivalent which accounts for both cellular and paracellular ion permeation routes in this epithelium is illustrated in Fig. 1 *B* (cf. Klyce, 1972*a*). The two resistances in the cellular route, R_a and R_b , represent the composite membrane resistances anterior and posterior to the micro-electrode tip, respectively.

A third resistance, R_c , parallels R_a and R_b , and represents the resistance of the paracellular pathway. Analysis of this circuit along with other evidence allowed the inference of the site of adrenaline action in the epithelium.

In this study, the potential difference and resistance across the corneal endothelium were neglected, since their values are small ($60 \Omega \text{ cm}^2$ and 1 mV , respectively) compared to those found for the epithelium. Asymmetries in liquid junction potentials were not corrected for in those instances when the cornea was bathed on one surface with normal Ringer and the other by SO_4 Ringer, since the error was estimated to be only 0.7 mV .

Generally, stable corneal resistances and potentials could be recorded for up to 5 hr, following an initial 90 min adaptation period to the isolation procedure. Only records obtained from those corneas showing a resistance greater than $6 \text{ k}\Omega \text{ cm}^2$ after 90 min were analysed.

RESULTS

Potential and resistance profiles. Under control conditions (90 min after mounting) epithelial resistance was found to be $9.1 \pm 0.5 \text{ k}\Omega \text{ cm}^2$ (mean \pm s.e. of mean), and epithelial potential was measured as $39.6 \pm 1.6 \text{ mV}$ ($n = 21$). Both these averages are significantly higher than those previously reported (Donn *et al.* 1959; Green, 1965; Ehlers & Ehlers, 1968; Klyce *et al.* 1973; Klyce, 1972*a*, 1975), which is most probably due to the use of silicone grease in mounting the tissue in order to reduce the effect of edge damage.

The potential and resistance profiles obtained with micro-electrodes were similar to those reported previously (Klyce, 1972*a*). The outer membrane of the squamous cell and the inner membrane of the basal cell (outer and inner surfaces of the epithelium) enclosed two regions of stable potential separated by a small central potential step across the transition region between wing cells and basal cells. The recording site in the present study could be inferred from the profiles obtained based on earlier findings which identified the cell types along the potential and resistance profiles by iontophoretic dye injection (Klyce, 1972*a*). As the micro-electrode penetrated the epithelium from the tear side to the stromal side, three potential steps were recorded on the average. A negative-going step of $-26.2 \pm 1.1 \text{ mV}$ was observed when the micro-electrode penetrated the outer membrane of the squamous cell. Further penetration into the epithelium produced no significant change in intracellular potential until the central potential step (the transition region between the wing and basal cells) of $-6.5 \pm 0.7 \text{ mV}$ was crossed. Finally, as the micro-electrode penetrated from the basal cell into the stroma, a positive step of $72.3 \pm 0.8 \text{ mV}$ was measured. The transepithelial potential measured with micro-electrodes was not significantly different from that measured simultaneously with the gross agar bridges. Accompanying the three potential steps, transverse membrane resistances were measured for the outer, central and inner barriers. These had values of $5.7 \pm 0.3 \text{ k}\Omega \text{ cm}^2$,

$1.1 \pm 0.1 \text{ k}\Omega \text{ cm}^2$, and $0.8 \pm 0.1 \text{ k}\Omega \text{ cm}^2$, respectively. Most of the residual resistance of about 16% occurred between the squamous cell and the deep wing cells, a region which was always isopotential.

Resistance changes produced by adrenaline. The concentration of adrenaline used in this study was low ($5 \times 10^{-10} \text{ M}$) and produced a transient response which could be elicited several times in the same preparation. In a typical experiment such as shown in Fig. 2*A*, a pulse of adrenaline delivered to the tear side bathing solution decreased the resistance of the cornea from $6.0 \text{ k}\Omega \text{ cm}^2$ to $3.3 \text{ k}\Omega \text{ cm}^2$ at minimum. After 5 min, the resistance returned to within 70% of the initial value, and its complete recovery generally required 15 min. Intracellular recordings showed that the resistance of the outer barrier (R_{ic}) changed from 5.0 to $2.1 \text{ k}\Omega \text{ cm}^2$ with the same time course as the decrease in epithelial resistance. On the other hand, the resistance of the inner barrier (R_{cs}) simultaneously increased from $1.0 \text{ k}\Omega \text{ cm}^2$ to a maximum value of $1.2 \text{ k}\Omega \text{ cm}^2$. Similar results were also obtained when recording from a basal cell (Fig. 2*B*). In this case corneal resistance decreased from $11.1 \text{ k}\Omega \text{ cm}^2$ to $5.99 \text{ k}\Omega \text{ cm}^2$. There was a decrease in the outer membrane resistance from 10.5 to $5.25 \text{ k}\Omega \text{ cm}^2$, while the inner membrane resistance again increased from 0.60 to $0.74 \text{ k}\Omega \text{ cm}^2$.

From the equivalent circuit depicted in Fig. 1*B*, it can be shown that

$$R_{ic} = R_i / (1 + R_i/R_a + R_b/R_a), \quad (1)$$

$$R_{cs} = R_i / (1 + R_i/R_b + R_a/R_b) \quad (2)$$

and

$$R_{is} = (R_a + R_b) R_i / (R_a + R_b + R_i). \quad (3)$$

Inspection of these equations shows that a rise in R_{cs} occurring simultaneously with a drop in R_{ic} and R_{is} can be caused only by a decrease in R_a . Hence, the major effect of adrenaline is on the cellular pathway resistance R_a .

Potential changes produced by adrenaline. Epithelial potential was also transiently altered by pulses of adrenaline with a time course similar to the resistance changes. However, the potential responses were neither large, nor did they always consist of a hyperpolarization; in a few experiments adrenaline depolarized epithelial potential, and in others no change in potential could be detected. In the experiment of Fig. 2*A*, adrenaline transiently increased epithelial potential by only 3.5 mV and in Fig. 2*B* by only 1.5 mV . There appeared to be some correlation between epithelial resting potential and the magnitude and polarity of the adrenaline response.

In order to study this further, corneas were polarized to different levels with the current clamp before the addition of adrenaline. In one experiment (illustrated in Fig. 3) the epithelial resting potential was 42 mV ,

and in this case adrenaline had no effect on the potential. When epithelial potential was increased to 90 mV with a $-5 \mu\text{A}/\text{cm}^2$ current, adrenaline led to a peak depolarization of 22 mV. Conversely, when the epithelial

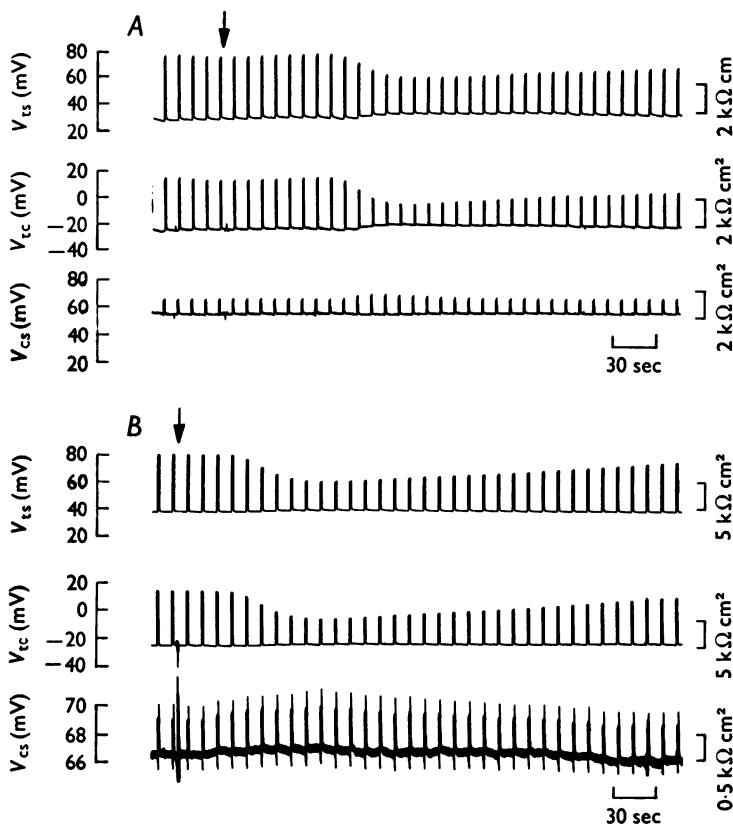

Fig. 2. The response of the outer barrier and inner barrier potentials and resistances to adrenaline applied at the outer surface. The time of addition of $2 \mu\text{l. } 10^{-7} \text{ M}$ adrenaline is indicated by \downarrow , resulting in a final concentration of approximately $5 \times 10^{-10} \text{ M}$. Constant current pulses were used to hyperpolarize the cornea for 1 sec every 10 sec for the resistance determinations. *A*, recording from a wing cell. The decrease in epithelial and outer barrier resistances were similar, but note the small increase in inner barrier resistance. *B*, recording from within a basal cell. Again, the major resistance change is at outer barrier, while the inner barrier resistance increased slightly.

potential was adjusted to 0 mV with a $+3 \mu\text{A}/\text{cm}^2$ current, adrenaline led to a 10 mV peak hyperpolarization. In both cases the response of epithelial potential was toward resting level (42 mV).

Simultaneously obtained intracellular recordings showed that the

$-5 \mu\text{A}/\text{cm}^2$ constant current depolarized the outer membrane by 44 mV and hyperpolarized the inner membrane by 4 mV. The $+3 \mu\text{A}/\text{cm}^2$ constant current hyperpolarized the outer membrane by 38 mV and depolarized the inner membrane by 4 mV. In response to adrenaline the

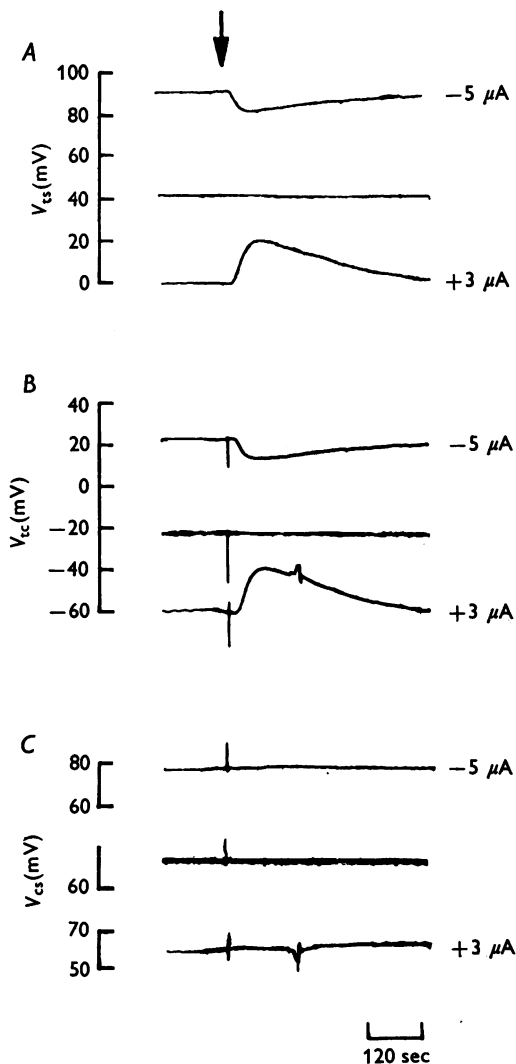

Fig. 3. Effect of biasing the epithelium with a current clamp on the adrenaline response of V_{ts} , V_{tc} , and V_{cs} . The records are simultaneously obtained at each current level. Adrenaline was added in each case at \downarrow . *A*, the influence of adrenaline on V_{ts} is determined by prestimulation potential. No response was found in this cornea at open circuit. *B*, the response of V_{tc} was similar to that in V_{ts} . *C*, no change in V_{cs} was detected in response to adrenaline.

changes in outer membrane potential (ΔV_{tc}) were identical in magnitude and time course to the response in transepithelial potential (ΔV_{ts}), while no significant change was produced in the inner membrane potential (ΔV_{cs}). In twelve corneas a linear correlation ($r = -0.98$) was found between ΔV_{ts} and ΔV_{tc} with a slope of -1.02 ± 0.26 and intercept of

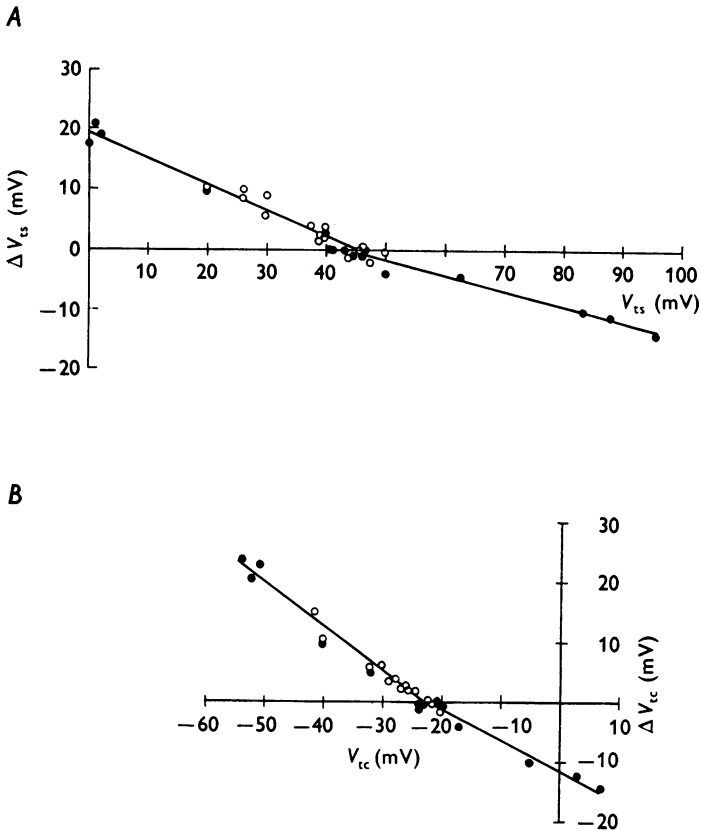

Fig. 4. Maximum change in potential produced by adrenaline as a function of prestimulation potential at open circuit (O) and current clamped across (●). A, relationship for the transepithelial potential (V_{ts}). B, relationship for the outer membrane (V_{tc}).

-0.09 ± 2.90 . Thus the response in V_{ts} when apparent was due solely to alterations in outer membrane potential. It should be noted that a reduction (depolarization) of the negative outer membrane potential will increase (hyperpolarize) epithelial potential when no other membrane potential is significantly altered (cf. Klyce, 1972a).

The peak of the epithelial potential response to adrenaline (ΔV_{ts}) as a function of V_{ts} was examined in Fig. 4A. Records were obtained from both

open circuit and current-clamped corneas. ΔV_{ts} consisted of a hyperpolarization when V_{ts} was below 44 mV and a depolarization when V_{ts} was above that value. While ΔV_{ts} was a linear function of V_{ts} for both hyperpolarizing and depolarizing responses, the slope of the relation was apparently discontinuous at $\Delta V_{ts} = 0$, which suggested the same type of rectification which was noted earlier for this epithelium (Klyce, 1972*a*) and which is also similar to that in the motoneurone (Coombs, Eccles & Fatt, 1955). The slopes for each direction of response were calculated separately, and the difference between them was found to be statistically significant ($P < 0.001$). The values of V_{ts} when $\Delta V_{ts} = 0$ (reversal potential) determined from the hyperpolarizing and depolarizing responses was 43.1 ± 6.2 and 45.1 ± 4.9 mV respectively. The difference between the two values was not statistically significant ($P > 0.7$).

There was a similar relationship for the peak response in outer membrane potential (ΔV_{tc}) and its resting potential (Fig. 4*B*). Again, there was a statistically significant difference between the slopes for the relationships between hyperpolarizing responses and depolarizing responses to V_{tc} ($P < 0.001$). The reversal potential for the outer membrane was calculated as 22.8 ± 2.9 mV when the cornea was hyperpolarized and 22.7 ± 4.0 mV when depolarized. The difference between the two values was not statistically significant ($P > 0.9$).

It is well established in other epithelia that a paracellular shunt will cause the potential generated at one cell surface to influence the potential measured across the other surface. The lower the resistance of the shunt, the larger this contribution (Schultz, 1972; Reuss & Finn, 1975). That this is also the case for the corneal epithelium was further supported by the experiment illustrated in Fig. 5. A low resistance shunt was produced by lightly scratching the outer corneal surface with a broken glass capillary. The immediate effects were a reduction in V_{ts} from 24 to 2 mV, a decrease in R_{ts} from 5 to $0.5 \text{ k}\Omega \text{ cm}^2$, an increase in V_{tc} from 30 to 60 mV, and a decrease in V_{cs} from 65 to 62 mV. Following the injury, adrenaline increased V_{ts} by only 2 mV. However, there was a simultaneous 9 mV depolarization of V_{tc} and a 7 mV depolarization of V_{cs} . Hence, in the presence of an abnormally low resistance paracellular pathway, changes in the potential of the outer membrane greatly influence the potential of the inner membrane. Since changes in V_{cs} are not normally observed, it was concluded that the paracellular pathway resistance in the normal preparation is high.

In three experiments, the stromal solution was changed to Ringer solution containing 5×10^{-10} M adrenaline. After a 2–3 min delay, the epithelial resistance decreased by more than 50% with a small effect on epithelial potential comparable to the above experiments in which adrenaline was added to the tear solution. Again the major resistance decrease occurred across the outer barrier, R_{tc} . Therefore, the resistance change produced by adrenaline appears to be specific to the outer barrier.

Cl dependence of the resistance change elicited by adrenaline. The contribution of Cl in the adrenaline response of the epithelium was examined in preparations incubated in Cl-free medium (SO_4 Ringer). Following SO_4 substitution on both corneal surfaces, transepithelial resistance increased

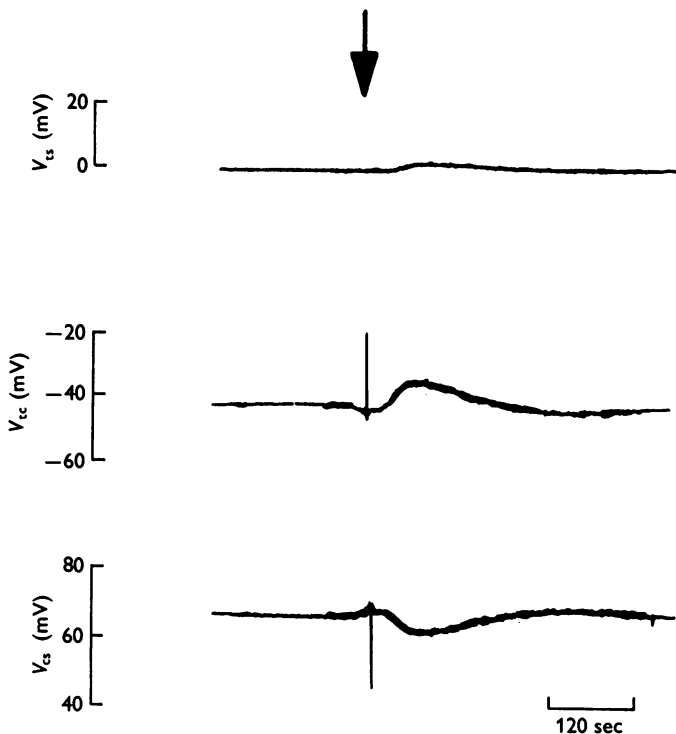

Fig. 5. Effect of adrenaline on V_{ts} , V_{tc} and V_{cs} in a low resistance preparation produced by injury. Adrenaline added at \downarrow produced a simultaneous change in both V_{tc} and V_{cs} . The effect on V_{cs} was not observed in normal high resistance preparations (cf. Fig. 3).

steadily for 100 min from $6.94 \pm 1.0 \text{ k}\Omega \text{ cm}^2$ to a stable level of $18.9 \pm 1.1 \text{ k}\Omega \text{ cm}^2$ ($n = 5$). SO_4 substitution also transiently increased transepithelial potential, but the potential after 100 min ($36.4 \pm 4.2 \text{ mV}$) was not significantly different ($P > 0.9$) from the control value in normal Ringer ($35.6 \pm 4.4 \text{ mV}$). After the new stable level of transepithelial resistance was obtained (100 min), no response to adrenaline in either transepithelial potential or resistance could be elicited. Hence, the increase in membrane permeability produced by adrenaline is probably due to an increase in Cl permeability alone, and from the earlier results it is apparent that this increase in Cl permeability occurs in the outer cellular membrane.

If, in fact, adrenaline does specifically increase the Cl permeability of the outer cellular membrane, the reversal potential (E_r) for the adrenaline response should represent the membrane potential at which no electrochemical potential gradient for Cl exists between the cell and the tear solution (Cl equilibrium potential). Since the Cl equilibrium potential, and hence E_r , should obey the Nernst equation, it follows that E_r should be proportional to the logarithm of the tear solution Cl concentration (when the cell Cl concentration is constant) and that the slope of the relationship should be equal to RT/F . To test these suggestions, E_r was determined for different tear solution Cl concentrations. The Cl concentration of the tear solution was rapidly changed from 103.4 to 72.5, 45.5 or 20.7 mM.

The immediate effect of lowering the tear solution Cl concentration was a hyperpolarization of the transepithelial potential and an increase in the transepithelial resistance which reached a steady value in 2 min, and which was completely reversible. After the epithelial potential and resistance had stabilized to a given solution, V_{tc} was set to three different levels with the current clamp during adrenaline treatment (Fig. 6A). The relationship between ΔV_{tc} and V_{tc} at the three levels was plotted, and the data were extrapolated to determine the value of the reversal potential ($E_r = V_{tc}$ at $\Delta V_{tc} = 0$; Fig. 6B). Fig. 6C shows that there was a good correlation ($r = -0.98$) between E_r and the logarithm of tear solution Cl concentration. The slope of the relationship determined by least squares was -56.2 mV/decade, which compares well with the slope of -60.9 mV/decade predicted by the Nernst equation. Fig. 6C also shows that $E_r = 0$ mV for a tear solution Cl concentration of 41.5 mM (range of 38.6–44.2 mM at the 95% confidence interval), a value that may be used to approximate the free solution equivalent of Cl concentration in the cells.

Total Cl replacement with SO_4 and the influence of ouabain on the adrenaline response. Since the membrane reversal potential experiments suggest that the conductance change produced by adrenaline is specific to Cl and since the major effect of adrenaline is on the outer cellular membrane, the direction of Cl movement across that membrane can be predicted by the polarity of the potential response. A hyperpolarizing response in epithelial potential produced by a depolarization of the outer cellular membrane and elicited by adrenaline should indicate outward Cl movement from the cells to the tears, whereas responses of the opposite polarity should indicate inward Cl movement. As indicated by Fig. 6, the adrenaline response of the epithelial potential can be used to assess cell Cl concentration. Based on this concept, in subsequent SO_4 substitution experiments it was possible to examine the hypothesis (Klyce, 1973) that Cl is transported across the epithelium by an active accumulation from the stroma to the cells and by a passive diffusion from the cells to the tear solution.

When the tear side was bathed with SO_4 Ringer (Cl-free), epithelial potential and resistance increased rapidly to new steady levels within

2 min. The potential increased from 34.5 ± 3.9 to 54.3 ± 6.1 mV, while the resistance increased from 8.35 ± 1.22 to 17.8 ± 2.3 k Ω cm² ($n = 8$). Adrenaline always elicited a hyperpolarizing response in epithelial potential when the tear solution was bathed with SO₄ Ringer (Table 1), and the

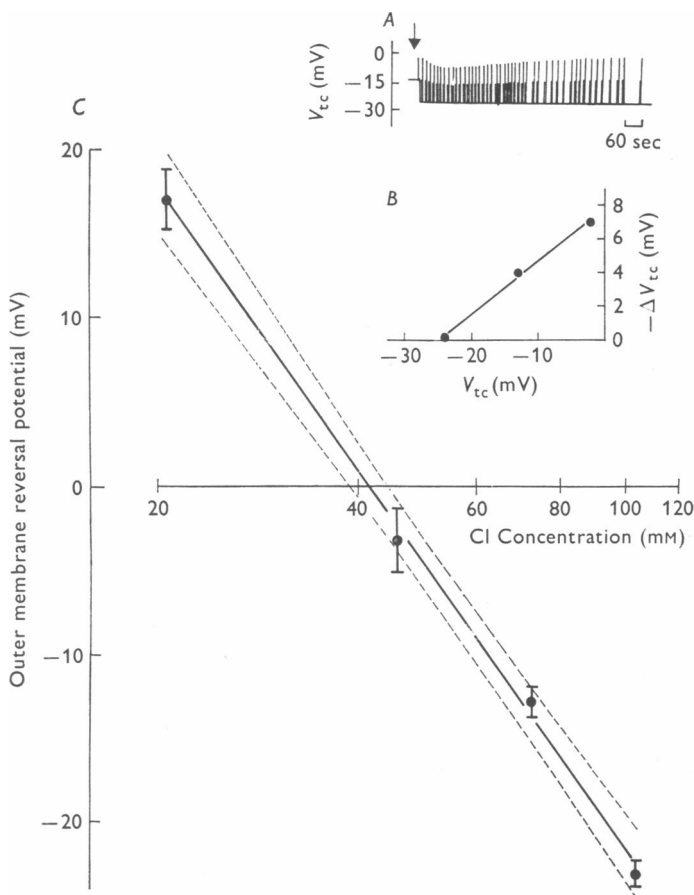

Fig. 6. The relationship between the adrenaline-produced outer membrane reversal potential and the concentration of tear side Cl. *A*, record of V_{tc} response to adrenaline added at \downarrow . Tear Cl concentration was 103.4 mM. The outer membrane was hyperpolarized with the current clamp near the expected reversal potential. Frequently the epithelium was open-circuited and alternately depolarized with the current clamp during the adrenaline response. Redrawn from original. *B*, the change in V_{tc} at the peak of the response to adrenaline was plotted as a function of prestimulation V_{tc} to obtain the reversal potential. *C*, mean of five determinations at each Cl concentration (\pm s.e.). Continuous line was calculated by least-squares linear fit of E_r vs. $\log_{10} [Cl]$. Dashed curves indicate the 95% confidence interval over the range of data.

amplitude of this response remained constant throughout the incubation period. Again the change in epithelial potential was entirely due to a depolarization of the outer membrane (Fig. 7A). In this situation there was only a 9% decrease in epithelial and outer membrane resistance, while no change in inner membrane resistance could be detected, probably due to the small magnitude of the overall resistance change. The polarity of the response in potential suggests that introducing SO₄ Ringer to the tear solution produced an electrochemical potential gradient favouring an outward movement of Cl from the cell to the tear solution. The fact that the peak amplitude of the response did not change throughout the incubation period suggests that the Cl content of the cell was constant.

TABLE 1. Peak response of epithelial resistance and potential to adrenaline after a Cl substitution

Solution		ΔR_{ts} (k Ω cm ²)	ΔV_{ts} (mV)
Tear	Stromal		
Cl	Cl	-4.9 \pm 0.7 (7)†	1.7 \pm 0.9 (7)
SO ₄	Cl	-2.3 \pm 0.7 (6)*	9.0 \pm 1.6 (6)†
Cl	SO ₄	-3.8 \pm 0.1 (5)†	-5.9 \pm 0.6 (5)†
SO ₄	SO ₄	no change (5)	no change (5)

Values tabulated are the mean \pm s.e. of mean (number of observations) for the changes in corneal resistance and potential at the peak of the response to adrenaline.

* $P < 0.02$, † $P < 0.001$.

When SO₄ Ringer bathed the stromal surface (tear side bathed with normal Ringer), epithelial potential was unchanged (28.8 \pm 3.7 mV in normal Ringer compared to 29.8 \pm 2.9 mV in SO₄ Ringer), and resistance increased slowly from 7.52 \pm 1.02 k Ω cm² to a new steady level at 100 min of 9.64 \pm 1.28 k Ω cm² ($n = 5$). Following the SO₄ substitution on the stromal side the adrenaline response of the epithelial potential (initially a hyperpolarization) gradually diminished in amplitude and became a depolarization (Fig. 7B). After a steady level of epithelial resistance had been achieved, it was found that the depolarization of epithelial potential in response to adrenaline was accompanied by a hyperpolarization of the outer membrane, and the decrease in epithelial resistance was accompanied by a decrease in outer membrane resistance plus a small increase in the inner membrane resistance (Fig. 7C). The epithelial potential responses elicited by adrenaline when the stromal side is bathed with SO₄ Ringer suggests that Cl is slowly depleted from the cells causing a reversal of the electrochemical potential gradient for Cl across the outer membrane, which then favours the movement of Cl from the tear solution to the cells.

To study the entry of Cl from the stroma to the cells, corneas were

bathed with SO_4 Ringer in the tear solution, and, at steady state, the magnitude of the peak of the hyperpolarizing adrenaline response in epithelial potential was determined (ΔV_{ts_0}). SO_4 Ringer was then also introduced to the stromal bathing solution, and the epithelial response to adrenaline was determined repeatedly (Fig. 8A). The magnitude of the

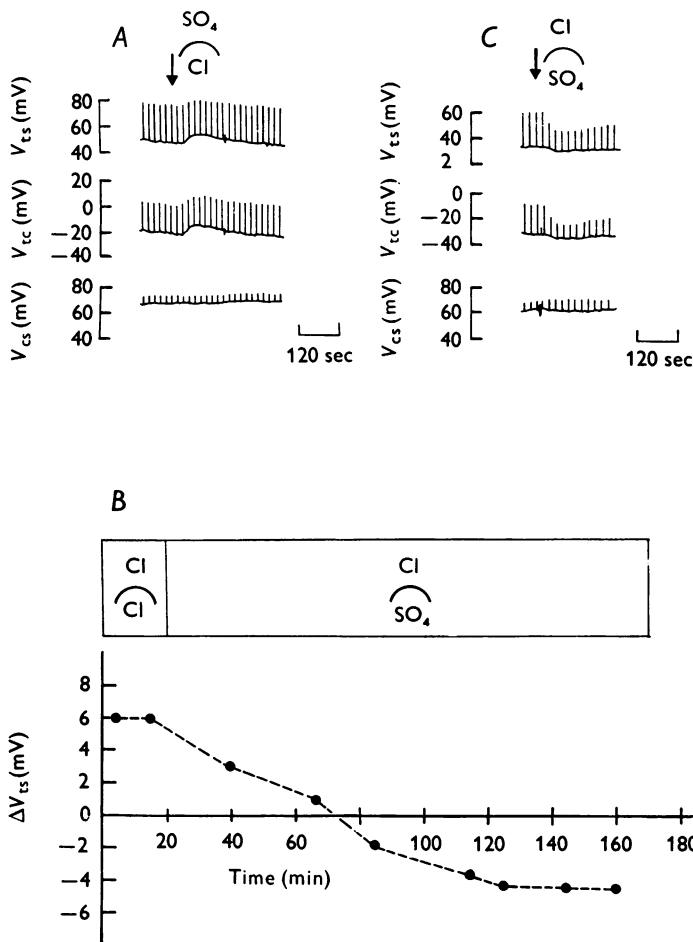

Fig. 7. Effect of Cl replacement on the peak epithelial potential response to adrenaline added at \downarrow . Corneas are represented by semicircles and the bathing solutions are indicated for the tear (convex) side and the stromal (concave) side. *A*, normal Cl content on the stromal side; total SO_4 substitution on the tear side. *B*, time course of the peak adrenaline response in epithelial potential following substitution of Cl on the stromal side. *C*, influence of adrenaline on epithelial, outer membrane and inner membrane potentials after a stable depolarizing response was found in V_w . *A* and *C* redrawn from original.

response (ΔV_{ts}) gradually fell, a result expected as a consequence of the slow depletion of cell Cl across the inner membrane. Finally, reintroduction of Cl to the stromal solution resulted in a gradual recovery of the adrenaline response to the control level, indicating that Cl was taken up by the depleted cells from the stromal solution. In five experiments the adrenaline response returned to $90.4 \pm 4.6\%$ of the control level. However, when ouabain was present in the stromal solution, the response recovered to

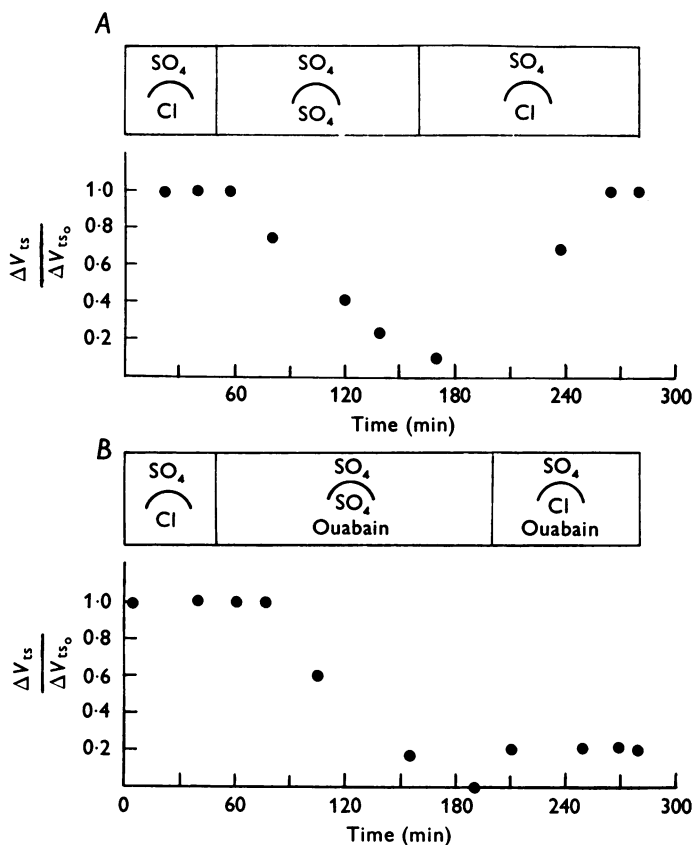

Fig. 8. Time course of the maximum response in V_{ts} following total Cl replacement with SO_4 on both corneal surfaces. ΔV_{ts} is the peak adrenaline response measured in any period. ΔV_{ts_0} is the peak response measured during the control period when the tear side was perfused with Cl-free medium and the stroma was bathed with Cl-containing Ringer. *A*, after obtaining a stable response with Cl-free solution on the tear side, Cl was removed from the stromal side. The adrenaline response recovered upon reintroduction of Cl to the stromal side. *B*, same as in *A*, but ouabain (10^{-5} M) was added during the depletion phase. Note the substantial inhibition of recovery.

only 20% of the control level (Fig. 8B), suggesting that ouabain inhibited the uptake of Cl across the inner membrane. In a group of 5 experiments the response recovered to only $14.2 \pm 1.6\%$ of the control level.

DISCUSSION

Micro-electrode analysis of corneal epithelial ion transport processes at the cellular level is facilitated by the absence of keratinized surface cells, but analysis is hampered by the same uncertainties as those encountered in frog skin epithelium (cf. Cereijido & Curran, 1965), since both are stratified. This may complicate the justification of a two series membrane model for ion transport as originally proposed for the frog skin by Koefoed-Johnsen & Ussing (1958). The potential and resistance responses to adrenaline in the cornea have been studied by recording from a deep wing cell. As noted above, this type of recording allows the determination of changes in the potential of the squamous cell outer membrane mainly because the squamous and wing cells are isopotential. However, interpretation of the resistance response requires the analysis of an epithelial model (Fig. 1B). Since the resistance elements of the model do not represent single membranes as would be possible for a monocellular epithelium, the influence of adrenaline on single membrane resistances can only be inferred (see below).

Site of the resistance change produced by adrenaline. The major electrophysiological response of the corneal epithelium to adrenaline was shown to be a decrease in the tissue resistance measured between the wing cell and the tear side bathing solution (Fig. 2). As pointed out above, the site of this resistance change is the outer cellular pathway resistance, R_a . The rise in R_{cs} produced by adrenaline was probably caused by an increase in the fraction of the total applied measuring current which would pass through the cellular pathway following a reduction in R_a . This increase should occur whether recording from a wing cell or a basal cell, as shown in Fig. 2. R_{cs} could have risen as a direct action of adrenaline (or cyclic AMP) on deeper membrane permeability or on cell ion composition, but the time course of the inner membrane resistance increase matched too closely the time course of the outer membrane resistance decrease to provide support for these possibilities.

The evidence thus suggests that adrenaline specifically reduces the outer cellular barrier resistance, R_a . R_a represents the resistance of all the cell layers between the micro-electrode tip and the tear solution, which includes several electrically coupled wing cell layers plus the resistance of the outer membrane of the squamous cell. Since the membrane potential response (ΔV_{tc}) was sensitive to tear side Cl concentration (Fig. 6),

adrenaline must have an effect on the squamous cell outer membrane – the barrier separating the cell cytoplasm from the tear solution. Conceivably, adrenaline could increase cell coupling in this situation, especially as cyclic AMP has been shown to increase cell coupling in the salivary gland (Hax, van Venrooij & Vossenbergh, 1974). However, since squamous and wing cells are normally electrically coupled well enough to sustain their isopotentiality, the possible contribution of increased coupling to the reduction in R_a must be small. Furthermore, the change in R_{tc} produced by adrenaline ($5 \text{ k}\Omega \text{ cm}^2$) was three times greater than the resistance measured between the squamous cell and the deep wing cell ($1.5 \text{ k}\Omega \text{ cm}^2$). Clearly, a large fraction of the change in R_a must occur at the outer membrane of the squamous cell.

The magnitude of the reversal potential for the epithelial potential response to adrenaline provided further evidence that adrenaline does not influence the resistance of the paracellular pathways. The tight junctions in this epithelium are at the apical surface and between the squamous cells. These junctions are impermeable to colloidal lanthanum (Leuenberger, 1973) and may have a resistance greater than $50 \text{ k}\Omega \text{ cm}^2$ (unpublished data). Even though these junctions are apparently a major diffusion barrier in the paracellular pathway, it may be assumed as a first approximation that when the cornea is bathed on each side by normal Ringer the concentration of Cl on each side of the junction is similar. If adrenaline specifically increased the Cl permeability of the tight junctions, then the reversal potential of the epithelium would have been close to 0 mV in contrast to the measured value of 44.5 mV. If the permeability change did occur in the tight junctions, then one would have to predict a Cl concentration in the subjunctional extracellular space of 0.5 M ($C_1 = C_o \exp [E_r F/RT]$), a value which is improbable. Assuming that the permeability change occurred in the outer membrane of the squamous cell, the reversal potential of that membrane would predict a cell Cl concentration of 42 mM, which is not unreasonable but does disagree with the value of 23 mM estimated previously in a semi-quantitative determination of the Cl content of epithelial scrapings (Otori, 1967). There is no simple explanation for this discrepancy.

The monophasic response of epithelial potential and resistance also suggests that adrenaline only influences the cellular pathway with no significant effect on the paracellular pathway. In another epithelium, viz. that of the frog skin, the response to adrenaline or noradrenaline is biphasic consisting of an initial depolarization followed by a hyperpolarization (Schoffeniels & Salee, 1965; Salee & Vidrequin-Deliege, 1967; Lindley, 1969; House, 1969, 1970, 1971). It was suggested that the initial depolarization was produced by ionic movement through a transient shunt in the

active mucous glands and that the hyperpolarization was generated by an increase in $P_{\text{Na}}/P_{\text{Cl}}$ in the epithelial outer membrane (House, 1969, 1970, 1971).

Specific ionic dependence of the adrenaline response. Perhaps the most convincing evidence suggesting that adrenaline specifically increased epithelial Cl permeability was the finding that total substitution of Cl with SO_4 in the bathing media abolished any detectible response to adrenaline (Table 1). In addition, previous experiments have shown that while theophylline and dibutyryl cyclic AMP increase epithelial Cl permeability from 5×10^{-4} to 11×10^{-4} cm/hr, no effect was noted in the permeability of Na or of urea (Klyce, 1975). However, it may be pointed out that the permeability increase may not be altogether unique to Cl. Rather it is probable that other small anions not present in the physiological Ringer solution could replace Cl. SO_4 was not able to substitute for Cl, nor apparently was the HCO_3 in the bathing fluid. On the other hand, the permeability of S^{14}CN was tripled by theophylline (unpublished data).

Cl specificity of the adrenaline response is also indicated by the nearly linear relationships between ΔV_{tc} vs. V_{tc} (Fig. 4B) and E_{r} vs. $\log C_0$ (Fig. 6C). An increase in ion permeability to 2 or more ion species would produce noticeable deviations from linearity in those relationships, except in the unlikely situation where the Nernst diffusion potentials for each species were identical. For example, the inhibitory post-synaptic potential in the cat motoneurone is thought to be caused by equal increases in the permeability of the cell membrane to Cl and K. In this cell the relationship between the membrane potential response to the inhibitory transmitter and the resting membrane potential is predictably non-linear (Coombs *et al.* 1955).

Catecholamines have also been shown to increase Cl permeability in the smooth muscle cell, where adrenaline increased membrane permeability to both Cl and K (Bülbring & Tomita, 1968; Tomita, Sakamoto & Ohba, 1974). Among its other effects on frog skin epithelium, adrenaline also increases Cl permeability of that epithelium in conjunction with the mucous gland secretion (Koefoed-Johnsen, Ussing & Zerahn, 1953; House, 1969; Tomlinson & Wood, 1976). That permeability change could be blocked by the β -adrenergic antagonist oxpranolol (Tomlinson & Wood, 1976) similar to the action of propranolol in the corneal epithelium, where complete inhibition of the adrenaline response can be achieved (unpublished data).

Chloride transport across the corneal epithelium and the influence of adrenaline. The source of catecholamines to the corneal epithelium *in vivo* might either be the circulation (a possibility due to the extreme sensitivity of the receptors), spillover from adrenergic fibres from other ocular

tissues, or release from adrenergic corneal nerve fibres demonstrated histochemically by Laties & Jacobowitz (1964) and by Tervo & Palkama (1976). It should be pointed out that the former two sources are eliminated in the isolation procedure, while the latter possible source is probably depleted shortly after dissection. Hence, in the isolated cornea, the sensitivity of the epithelium to adrenaline should be fairly high.

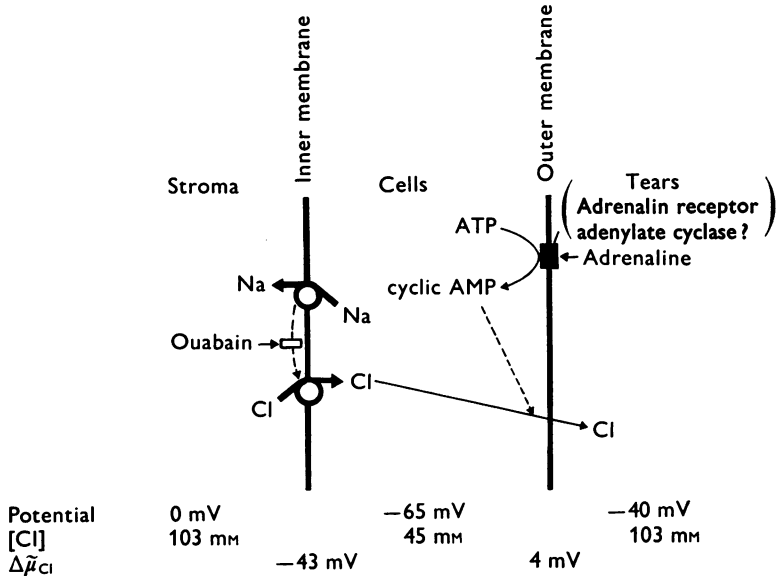

Fig. 9. Model for adrenaline influence on corneal epithelial Cl transport. Potential and Cl concentrations $[Cl]$ for the stroma, cells and tear solution are listed, as well as the Cl electrochemical potential gradients ($\Delta\tilde{\mu}_{Cl}$) across the inner and outer membranes. See text for additional details.

Whatever pathway is the primary source of catecholamines *in vivo*, there is strong evidence that once there, adrenaline (or noradrenaline) stimulates Cl secretion via cell cyclic AMP. The activity of adrenaline can be abolished by the β -adrenergic antagonist propranolol (unpublished data). The increase in Cl secretion produced by adrenaline is mimicked by the methyl xanthine group of phosphodiesterase inhibitors (Klyce *et al.* 1973). The dibutyryl derivative of cyclic AMP also mimicks the epithelial response to catecholamines and phosphodiesterase inhibition; furthermore, adrenaline in combination with theophylline doubles the amount of cyclic AMP assayed in incubated corneas (Klyce *et al.* 1973). Hence, it is probable that adrenaline through β -receptor action stimulates adenylate cyclase, increasing cell cyclic AMP content, which in turn leads to the increase in outer membrane Cl permeability observed.

Since the average outer membrane potential was -26.2 mV and the Cl reversal potential of that membrane was -22.4 mV, then the Cl electrochemical potential gradient normally favours the passive movement of Cl from the cells to the tears (Fig. 9). The rate of this diffusive process is apparently modulated by adrenaline. The outer membrane appears to be the rate limiting step in the transcellular transport of Cl. When the tear side is made Cl-free with SO_4 Ringer, the peak adrenaline response of the epithelial potential increases to a steady hyperpolarizing value in less than 5 min. Sustained incubation for over 60 min does not alter the magnitude of the response (Fig. 8), suggesting the independence of cell Cl concentration from tear side concentration. This is also indicated by the linear relationship between the outer membrane reversal potential and the logarithm of tear side (Cl). The lack of influence of the Cl concentration of the tear solution on the Cl content of the cell suggests that even when outward Cl movement was enhanced, no change in cell Cl content occurred because the loss was adequately compensated by the entry of Cl from the stromal solution.

The entry of Cl from the stromal solution to the cells is against an electrochemical potential gradient equivalent to 43 mV (inner membrane potential less the Cl equilibrium potential). Therefore, in order to maintain a greater Cl concentration in the cells than can be predicted by passive diffusion, some active process must transport Cl into the cells in such a way as to cause net epithelial Cl secretion. Since ouabain apparently blocks the re-entry of Cl from the stromal side to the cells (Fig. 8) and since adrenaline-stimulated Cl secretion is apparently dependent upon an adequate supply of stromal Na (Fisher & Zadunaisky, 1975), it would appear that Cl entry is coupled to Na-K activated ATPase and/or the Na pump in this epithelium. It may be noted that no change in the inner membrane potential occurred during the adrenaline response. Possibly the entry process occurs by an electroneutral mechanism, or under the conditions of minimal stimulation, as in this study, the electrogenicity of the pump was too small to be detected.

The present results support a model for Cl secretion in this epithelium summarized in Fig. 9 in part suggested earlier from thermodynamic considerations alone (Klyce, 1973). The inner barrier, R_b (composed of some combination of the basolateral membrane of the germinative cells and possibly the deep wing cell membranes), is the site of an active Cl transport into the cellular pathway, which is in some fashion coupled to the transport of Na at that site. Intracellular Cl diffuses passively outward from the cell to the tears down a small electrochemical potential gradient equivalent to a few mV. This diffusive process can be enhanced by adrenaline via adenylate cyclase stimulation and cyclic AMP production within the cell.

As shown previously (Klyce, 1975), the consequence of this increased outer membrane Cl permeability at corneal resting potential is the secretory movement of Cl accompanied by Na and water from the stroma to the tears, a movement which can dehydrate the corneal stroma.

The authors are thankful to Drs David M. Maurice and Michael F. Marmor for their critical perusal of this paper and to Mr Otto Bernegger for his skilful assistance in this study. This work was supported by USPHS Research Grant EY-00915 and Training Grant EY-00051 from the National Eye Institute.

REFERENCES

- BÜLBRING, E. & TOMITA, T. (1969). Suppression of spontaneous spike generation by catecholamines in the smooth muscle of the guinea-pig taenia coli. *Proc. R. Soc. B* **172**, 103-119.
- CERELJIDO, M. & CURRAN, P. F. (1965). Intracellular electrical potentials in frog skin. *J. gen. Physiol.* **48**, 543-559.
- COOMBS, J. S., ECCLES, J. C. & FATT, P. (1955). The electrical properties of the motoneurone membrane. *J. Physiol.* **130**, 291-325.
- DONN, A., MAURICE, D. M. & MILLS, N. (1959). Studies in the living cornea in vitro. II. The active transport of sodium across the epithelium. *Archs Ophthalm., N.Y.* **62**, 748-757.
- EHLERS, N. & EHLERS, D. (1968). Effects of hydrostatic and colloid osmotic pressure on electrical potential and short-circuit current across the explanted rabbit cornea. *Acta Ophthalm.* **46**, 767-778.
- FISHER, F. H. & ZADUNAISKY, J. A. (1975). Sodium requirement for the chloride transport stimulation by epinephrine in the rabbit corneal epithelium. *Physiologist, Wash.* **18**, 214.
- GREEN, K. (1965). Ion transport in isolated cornea of the rabbit. *Am. J. Physiol.* **209**, 1311-1316.
- HAX, W. M. A., VAN VENROOIJ, G. E. P. M. & VOSSENBERG, J. B. J. (1974). Cell communication: A cyclic-AMP mediated phenomenon. *J. Membrane Biol.* **19**, 253-266.
- HOUSE, C. R. (1969). The role of glandular activity in the electrical response of amphibian skin to noradrenaline. *J. Physiol.* **202**, 631-644.
- HOUSE, C. R. (1970). The effect of noradrenaline on the toad skin potential. *J. Physiol.* **209**, 513-537.
- HOUSE, C. R. (1971). The effect of different ionic levels on the electrical response of toad skin to noradrenaline. *J. Physiol.* **218**, 305-324.
- KLYCE, S. D. (1972*a*). Electrical profiles in the corneal epithelium. *J. Physiol.* **226**, 407-429.
- KLYCE, S. D. (1972*b*). Microelectrode and tracer analysis of ion transport in the rabbit corneal epithelium. *Abstracts of the IV International Biophysics Congress, Moscow*, vol. **3**, p. 106.
- KLYCE, S. D. (1973). Relationship of epithelial membrane potentials to corneal potential. *Expl Eye Res.* **15**, 567-575.
- KLYCE, S. D. (1975). Transport of Na, Cl, and water by the rabbit corneal epithelium at resting potential. *Am. J. Physiol.* **228**, 1446-1452.
- KLYCE, S. D., NEUFELD, A. H. & ZADUNAISKY, J. A. (1973). The activation of chloride transport by epinephrine and Db-cyclic AMP in the cornea of the rabbit. *Invest. Ophthalm.* **12**, 127-139.

- KOEFOED-JOHNSEN, V. & USSING, H. H. (1958). Nature of the frog skin potential. *Acta physiol. scand.* **42**, 298-308.
- KOEFOED-JOHNSEN, V., USSING, H. H. & ZERAHN, K. (1953). The origin of the short-circuit current in the adrenaline stimulated frog skin. *Acta physiol. scand.* **27**, 38-48.
- LATIES, A. & JOCOBINOWITZ, D. (1964). A histochemical study of the adrenergic and cholinergic innervation of the anterior segment of the rabbit eye. *Invest. Ophthalm.* **3**, 592-600.
- LEUENBERGER, P. M. (1973). Lanthanum hydroxide tracer studies on rat corneal endothelium. *Expl Eye Res.* **15**, 85-91.
- LEWIS, S. A. & DIAMOND, J. M. (1975). Active sodium transport by mammalian urinary bladder. *Nature, Lond.* **253**, 747-748.
- LINDLEY, B. D. (1969). Nerve stimulation and electrical properties of the frog skin. *J. gen. Physiol.* **53**, 427-449.
- MAURICE, D. M. (1967). Epithelial potential of the cornea. *Expl Eye Res.* **6**, 138-140.
- MAURICE, D. M. (1972). The location of the fluid pump in the cornea. *J. Physiol.* **221**, 43-54.
- OTORI, T. (1967). Electrolyte content of the rabbit corneal stroma. *Expl Eye Res.* **6**, 356-367.
- REUSS, L. & FINN, A. L. (1975). Dependence of serosal membrane potential on mucosal membrane potential in toad urinary bladder. *Biophys. J.* **15**, 71-75.
- SALEE, M. L. & VIRDREQUIN-DELIEGE, M. (1967). Nervous control of the permeability characteristics of the isolated skin of the toad, *Bufo bufo* L. *Comp. Biochem. Physiol.* **23**, 583-597.
- SCHOFFENIELS, E. & SALEE, M. L. (1965). The effects of the electrical stimulation of the brachial plexus on the potential difference of frog skin. *Comp. Biochem. Physiol.* **14**, 587-602.
- SCHULTZ, S. G. (1972). Electrical potential differences and electromotive forces in epithelial tissues. *J. gen. Physiol.* **59**, 794-798.
- TASAKI, I., TSUKAHAVA, Y., ITO, S., WAYNER, M. J. & YU, W. Y. (1968). A simple direct and rapid method for filling microelectrodes. *Physiol. & Behav.* **3**, 1009-1010.
- TENG, C. C. (1961). The fine structure of the corneal epithelium and basement membrane of the rabbit. *Am. J. Ophthalm.* **51**, 278-297.
- TERVO, T. & PALKAMA, A. (1976). Adrenergic innervation of the rat corneal epithelium. *Invest. Ophthalm.* **15**, 147-150.
- TOMITA, T., SAKAMOTO, Y. & OHBA, M. (1974). Conductance increase by adrenaline in guinea pig taenia coli studied with voltage clamp method. *Nature, Lond.* **250**, 432-433.
- TOMLINSON, R. W. S. & WOOD, A. W. (1976). Catecholamine-induced changes in ion transport in short-circuited frog skin and the effect of β -blockage. *J. Physiol.* **257**, 515-530.
- VAN DER HEYDEN, C., WEEKERS, J. F. & SCHOFFENIELS, E. (1975). Sodium and chloride transport across the isolated rabbit cornea. *Expl Eye Res.* **20**, 89-96.