

## Sialyl Lewis<sup>X</sup>-Mediated, PSGL-1-Independent Rolling Adhesion on P-selectin

Stephen D. Rodgers,\* Raymond T. Camphausen,<sup>†</sup> and Daniel A. Hammer\*

\*Department of Chemical Engineering and Institute for Medicine and Engineering, University of Pennsylvania, Philadelphia, Pennsylvania 19107, and <sup>†</sup>Genetics Institute, Cambridge, Massachusetts 02140 USA

**ABSTRACT** Selectin-mediated cell adhesion is an essential component of the inflammatory response. In an attempt to unambiguously identify molecular features of ligands that are necessary to support rolling adhesion on P-selectin, we have used a reconstituted ("cell-free") system in which ligand-coated beads are perfused over soluble P-selectin surfaces. We find that beads coated with the saccharides sialyl Lewis<sup>X</sup> (sLe<sup>X</sup>), sialyl Lewis<sup>a</sup> (sLe<sup>a</sup>), and sulfated Lewis<sup>X</sup> (HSO<sub>3</sub>Le<sup>X</sup>) support rolling adhesion on P-selectin surfaces. Although it has been suggested that glycosylation and sulfation of P-selectin glycoprotein ligand-1 (PSGL-1) is required for high-affinity binding and rolling on P-selectin, our findings indicate that sulfation of N-terminal tyrosine residues is not required for binding or rolling. However, beads coated with a tyrosine-sulfated, sLe<sup>X</sup>-modified, PSGL-1-Fc chimera support slower rolling on P-selectin than beads coated with sLe<sup>X</sup> alone, suggesting that sulfation improves rolling adhesion by modulating binding to P-selectin. In addition, we find it is not necessary that P-selectin carbohydrate ligands be multivalent for robust rolling to occur. Our results demonstrate that beads coated with monovalent sLe<sup>X</sup>, exhibiting a more sparse distribution of carbohydrate than a similar amount of the multivalent form, are sufficient to yield rolling adhesion. The relative abilities of various ligands to support rolling on P-selectin are quantitatively examined among themselves and in comparison to human neutrophils. Using stop-time distributions, rolling dynamics at video frame rate resolution, and the average and variance of the rolling velocity, we find that P-selectin ligands display the following quantitative trend, in order of decreasing ability to support rolling adhesion on P-selectin: PSGL-1-Fc > sLe<sup>a</sup> ~ sLe<sup>X</sup> > HSO<sub>3</sub>Le<sup>X</sup>.

### INTRODUCTION

The adhesion of circulating leukocytes to the vascular wall occurs routinely in the normal course of lymphocyte recirculation and the inflammatory response. In such processes, adhesion molecules on the surface of leukocytes interact with complementary adhesion molecules expressed on the luminal surface of endothelial cells. These interactions result in the transient, dynamic adhesion (rolling) of cells to the vascular wall, which is followed by firm arrest and diapedesis (Springer, 1994). Much work has been done to identify and characterize the adhesion molecules participating in these events. The selectin family (L-, E-, and P-selectin) of cell adhesion molecules has been identified as the principal mediators of the initial tethering and rolling of circulating leukocytes along the endothelium. Although they are differentially expressed, all selectins are known to bind, with low affinity, the carbohydrate structure sLe<sup>X</sup> (sialyl Lewis<sup>X</sup>), as well as its isomer sLe<sup>a</sup> (sialyl Lewis<sup>a</sup>) (Berg et al., 1991, 1992; Foxall et al., 1992; Handa et al., 1991; Polley et al., 1991). sLe<sup>X</sup> is a tetrasaccharide composed of galactose, *N*-acetylglucosamine, fucose, and sialic acid. It is expressed on the surface of all circulating leukocytes and is also known to be elevated in tumor cells,

particularly carcinomas (Fukuda and Hindsgaul, 1994; Fukushima et al., 1984; Hakamori, 1989, 1996; Takada et al., 1991).

Though sLe<sup>X</sup>-like carbohydrates are likely the biological ligands for E-selectin, higher affinity, mucin-type ligands for both L- and P-selectin have been identified, perhaps the best characterized of which is P-selectin glycoprotein ligand-1 (PSGL-1). PSGL-1 is a homodimeric sialomucin ligand for P-selectin that is expressed on the surface of almost all circulating leukocytes (Laszik et al., 1996; McEver and Cummings, 1997). The anionic N terminus of mature PSGL-1 contains a cluster of three tyrosine residues, one or more of which can be sulfated, and a putative, sLe<sup>X</sup>-modified glycan at Thr<sup>16</sup>. High-affinity binding of P-selectin requires both of these posttranslational modifications of PSGL-1 (Pouyani and Seed, 1995; Sako et al., 1995; Wilkins et al., 1995). Cleavage of *O*-glycan-containing regions, or of sialic acid groups, as well as treatment with sulfation inhibitors, enzymatic removal of sulfate, or conversion of sulfate bearing-tyrosine residues to phenylalanine, was shown to effectively eliminate PSGL-1 binding to P-selectin (Goetz et al., 1997; Li et al., 1996; Liu et al., 1998; Pouyani and Seed, 1995; Sako et al., 1995; Wilkins et al., 1995). Clearly a consensus has been reached about the importance of both sLe<sup>X</sup> and sulfated tyrosine for the maintenance of proper adhesive interactions between PSGL-1 and P-selectin. However, it is not apparent from these experiments whether sLe<sup>X</sup> by itself, not necessarily in the context of PSGL-1, is capable of supporting rolling adhesion on P-selectin.

Received for publication 18 October 1999 and in final form 4 May 2000.

Address reprint requests to Dr. Daniel A. Hammer, Department of Bioengineering, University of Pennsylvania, 120 Hayden Hall, 3320 Smith Walk, Philadelphia, PA 19104. Tel.: 215-573-6761; Fax: 215-573-2093; E-mail: hammer@seas.upenn.edu.

© 2000 by the Biophysical Society

0006-3495/00/08/694/13 \$2.00

Our laboratory has developed an assay for the unambiguous identification of ligands that support rolling adhesion on the selectins. In this technique, we immobilize putative ligands on polystyrene microspheres and measure their adhesion to selectin-coated surfaces in a flow chamber. Using this method, we have previously examined rolling adhesion mediated by low-affinity, E-selectin/sLe<sup>X</sup>, and L-selectin/sLe<sup>X</sup> interactions (Goetz et al., 1996a; Brunk and Hammer, 1997; Brunk, 1997). Although sLe<sup>X</sup>, sLe<sup>a</sup>, and HSO<sub>3</sub>Le<sup>X</sup> (an sLe<sup>X</sup>-related structure in which sialic acid is replaced by HSO<sub>3</sub>) produced rolling, adhesive interactions on both E- and L-selectin surfaces, it is still unclear whether P-selectin/sLe<sup>X</sup> interactions, which are of similar affinity, are sufficient to support adhesion under flow. Consistent with the idea that sLe<sup>X</sup> could support rolling adhesion on P-selectin, affinity and kinetic measurements between sLe<sup>X</sup> and each of the selectins, including P-selectin, show great similarity (Jacob et al., 1995; Poppe et al., 1997). Because adhesion under flow is ultimately determined by such parameters (Chang, 1996; Hammer and Lauffenburger, 1987; Hammer and Apte, 1992), we would expect similar adhesive behavior to be mediated by sLe<sup>X</sup> and each of the selectins.

In the current work, we extend our findings, using a cell-free system, to show that these same carbohydrates can also mediate dynamic adhesive interactions on P-selectin, in the absence of more complex glycoprotein structures. We compare the rolling dynamics mediated by sLe<sup>X</sup>, sLe<sup>a</sup>, HSO<sub>3</sub>Le<sup>X</sup>, and a soluble Ig construct of PSGL-1 modified by both tyrosine sulfate and sLe<sup>X</sup>. We find that tyrosine sulfation modulates (improves) rolling but is not required for rolling, in contrast to what might be inferred from the measurements of other investigators. In addition, we show that at nearly equivalent site densities, both multi- and monovalent sLe<sup>X</sup> can mediate rolling adhesion on P-selectin, indicating that multivalency is not required for adhesion to P-selectin.

## EXPERIMENTAL METHODS

### Adhesion molecules and antibodies

Soluble, recombinant P-selectin (sP-selectin), containing the entire extracellular portion of the molecule, was expressed in Chinese hamster ovary cells and purified by conventional chromatography. A soluble Ig construct of PSGL-1 (19.EK.Fc) was described earlier (Goetz et al., 1997). 19.EK.Fc consists of the N-terminal 19 amino acids of mature PSGL-1 and is a mixture of isoforms. It is differentially modified by sulfation of tyrosine residues and sLe<sup>X</sup> modification of an *O*-glycan at Thr<sup>16</sup>. Fig. 1 A shows a schematic structure of the 19.EK.Fc chimera, including three sulfated tyrosine residues and a single *O*-linked glycosylation site. Anti-P-selectin monoclonal antibodies (mAbs) G1 and WAPS were purchased from Ancell Corporation (Bayport, MN) and Zymed Laboratories (San Francisco, CA), respectively, and anti-E-selectin mAb BB11 was purchased from Berkeley Antibody Company (San Francisco, CA). Anti-sLe<sup>X</sup> mAb HECA-452, anti-PSGL-1 mAb KPL1, fluorescein isothiocyanate (FITC)-labeled anti-rat IgM, and FITC-labeled anti-mouse IgG<sub>1</sub> were purchased from Pharmingen (San Diego, CA). All biotinylated carbohydrate probes used in this work were purchased from Glycotect (Rockville, MD). Multivalent, bio-

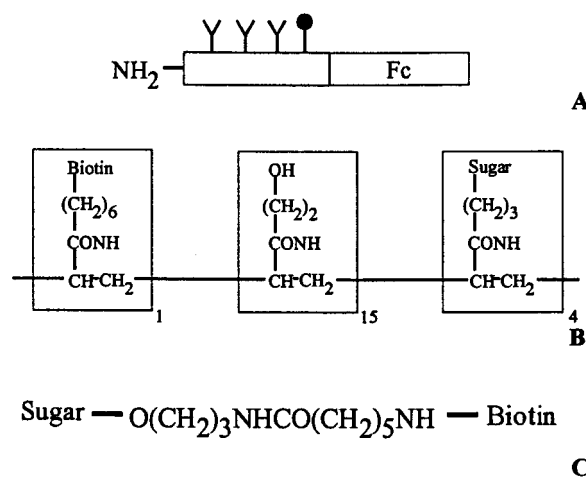

FIGURE 1 Structures of immobilized ligands. (A) Schematic of 19.EK.Fc chimera. Y-shaped symbols indicate tyrosine residues, and the filled circle indicates the *O*-linked glycosylation site at threonine 16. (B and C) Structures of multivalent and monovalent (respectively) carbohydrate probes. Molecular weights are ~30,000 kDa for the multivalent form and 3000 Da for the monovalent form.

tinylated sLe<sup>X</sup>, sLe<sup>a</sup>, HSO<sub>3</sub>Le<sup>X</sup>, and Lewis<sup>X</sup> (Le<sup>X</sup>) were used as part of a polyacrylamide matrix containing multiple biotin and carbohydrate groups, with a molecular mass of ~30,000 kDa. The multivalent structure is shown in Fig. 1 B, where "sugar" represents the carbohydrate group of interest. Fig. 1 C shows the structure of monovalent sLe<sup>X</sup>, which is separated from a single biotin group by a nine carbon spacer arm. This molecule has a mass of ~3000 Da.

### Preparation of substrates

Interior divisions of one-half of eight well, Flexiperm gaskets (Heraeus Instruments, South Plainfield, NJ) were removed to create single wells. Modified gaskets were placed on microscope slides cut from 100-cm-diameter bacteriological polystyrene dishes (Becton Dickinson, Bedford, MA). sP-Selectin was diluted to the desired coating concentration in binding buffer (0.1 M NaHCO<sub>3</sub>, pH 9.2), and 800  $\mu$ l was incubated on slides for 2 h at room temperature. For most experiments, surfaces were coated with 10  $\mu$ g/ml of sP-selectin. Surfaces were then washed once with Dulbecco's phosphate-buffered saline (DPBS) (pH 7.4) containing calcium and magnesium ions (Sigma, St. Louis, MO) and incubated with 800  $\mu$ l of a heat-denatured solution of 2% bovine serum albumin (BSA) in DPBS for a minimum of 30 min. Before use in laminar flow assays, slides were incubated for 2 min with 1% Tween 20 in DPBS. All slides were prepared the same day as the experiments in which they were used. Control surfaces were prepared using the BSA blocking step only, or by incubating with 800  $\mu$ l (20  $\mu$ g/ml) of anti-selectin antibodies in DPBS with 1% BSA and 0.01% sodium azide (DPBS<sup>+</sup>) for 1 h. This additional step was completed after BSA blocking of the surface.

### Protein iodination

mAb G1 (100  $\mu$ g) was iodinated with 1 mCi of carrier-free Na<sup>125</sup>I (Amersham Pharmacia Biotech, Piscataway, NJ), using an Iodobead method (Pierce Chemical, Rockford, IL). Unreacted <sup>125</sup>I was removed by the use of a 5-ml gel filtration column (D-Salt; Pierce Chemical) equilibrated in elution buffer (100 mM Na<sub>2</sub>HPO<sub>4</sub>, 150 mM 1% BSA, 0.01% sodium azide). Postcolumn fractions were collected and examined for labeled

protein content on a Cobra Quantum 5002 gamma counter (Packard Instrument Company, Meriden, CT). Fractions corresponding to the labeled protein peak were combined, aliquoted, and stored for use in binding assays. Specific activity was determined by comparing trichloroacetic acid (60%)-precipitated and unprecipitated cpm on precolumn samples of reaction mixture. The antibody concentration was determined from cpm on postcolumn fractions and specific activity. The procedure yielded antibody with a specific activity of 1.8  $\mu\text{Ci}/\mu\text{g}$  and a concentration of 90  $\mu\text{g}/\text{ml}$ .

### Determination of selectin site density

Sixty microliters of sP-selectin in binding buffer (at concentrations corresponding to those used in laminar flow assays) was adsorbed to untreated polystyrene wells in a remove-a-well strip arrangement (Evergreen Scientific, Los Angeles, CA). Adsorption continued for 2 h at room temperature, followed by washing three times with DPBS. Wells were then blocked for 2 h with 300  $\mu\text{l}$  of a heat-denatured solution of 2% BSA in DPBS. After blocking, wells were incubated for 1 h with 60  $\mu\text{l}$  of a saturating concentration (3  $\mu\text{g}/\text{ml}$ , data not shown) of labeled G1. Wells were washed five times with DPBS, broken apart, and placed in tubes for gamma counting. To measure nonspecific binding, labeled G1 was added to wells treated as above, to which no sP-selectin had been added. Specific binding was calculated as cpm bound to selectin-coated wells minus cpm bound to wells blocked only with BSA. Site densities were calculated based on saturation binding, assuming binding of one antibody per adhesion molecule/antigen.

### Preparation of microspheres

Microspheres (beads, 10.9- $\mu\text{m}$  diameter, Superavidin-coated and 10.4- $\mu\text{m}$  diameter, protein A-coated) were purchased from Bangs Laboratories (Fishers, IN). Biotinylated, multivalent sLe<sup>X</sup>, sLe<sup>a</sup>, HSO<sub>3</sub>Le<sup>X</sup>, Le<sup>X</sup>, or monovalent sLe<sup>X</sup> was diluted to the desired coating concentration in DPBS<sup>+</sup> for attachment to Superavidin beads. For most experiments, a coating concentration of 0.5  $\mu\text{g}/\text{ml}$  of carbohydrate was used. Similarly, 19.EK.Fc was prepared for attachment to protein A-coated beads. For laminar flow assays, 10<sup>6</sup> beads were incubated with 100  $\mu\text{l}$  of biotinylated carbohydrate or 19.EK.Fc for 45 min at room temperature, with occasional vortexing. Beads were then washed three times in DPBS<sup>+</sup> and resuspended in 2 ml of DPBS<sup>+</sup> until ready for use in adhesion experiments. For control studies, beads were coated with 1  $\mu\text{g}/\text{ml}$  D-biotin in DPBS<sup>+</sup>.

### Isolation of human neutrophils

Venous blood was drawn from healthy adults into sterile tubes containing EDTA anticoagulant (Vacutainer; Becton-Dickinson, Franklin Lakes, NJ), and a one-step Ficoll-Hypaque density gradient (Neutrophil Isolation Medium; Cardinal Associates, Sante Fe, NM) was used to separate neutrophils. Anticoagulated blood (3.5 ml) was layered over 3 ml of separation medium in a sterile 13 × 100 mm plastic tube and centrifuged at 1000 × *g* for ~80 min. This centrifugation time was found to be optimal for eliminating red blood cell contamination of the neutrophil band, obviating the need for the addition of red blood cell lysing agents. After centrifugation, the neutrophil band was removed with a sterile 18G needle and syringe and placed into 10 ml of Hanks' balanced salt solution (HBSS<sup>+</sup>) (HBSS, 10 mM HEPES (pH 7.4), 2 mM Ca<sup>2+</sup>, 0.5% human serum albumin (HSA)) until use in adhesion assays or flow cytometry. Neutrophils were used within 4 h of isolation. Over this time course, morphological as well as flow cytometric analysis (CD18 expression) indicated no cell activation because of the low concentration of Ca<sup>2+</sup> ions in the storage buffer. Viability was routinely greater than 95%, as determined by trypan blue exclusion.

### Flow cytometry

For bead preparation, all steps were performed at room temperature, using DPBS<sup>+</sup> for bead washing and dilution of antibodies. Neutrophil preparations were kept on ice, and HBSS<sup>+</sup> was used for cell washing and the dilution of antibodies. Before analysis of expression levels, saturating concentrations of all primary and secondary antibodies were determined by titration of antibody coating concentrations, binding to ligand-coated beads, and examination of peak fluorescence values obtained from fluorescence histograms. For analysis of sLe<sup>X</sup> groups, 10<sup>5</sup> beads or neutrophils were incubated for 45 min with 50  $\mu\text{l}$  of HECA-452 (20  $\mu\text{g}/\text{ml}$ ). Beads and cells were then washed twice and incubated for 30 min with 50  $\mu\text{l}$  of secondary, FITC-labeled anti-rat IgM mAb (20  $\mu\text{g}/\text{ml}$ ). After the secondary incubation, beads and cells were washed three times and fixed with 1% formaldehyde in DPBS. Similar procedures were followed to quantify the amount of chimera immobilized on protein A beads and the number of PSGL-1 groups present on neutrophils. In this case, mAb PSL275 (Kumar et al., 1996) or KPL1 (10  $\mu\text{g}/\text{ml}$ ) and FITC-labeled anti-mouse IgG<sub>1</sub> secondary antibody (20  $\mu\text{g}/\text{ml}$ ) were used. In the preparation of protein A-coated beads for analysis, after binding of 19.EK.Fc and before labeling with primary mAb, beads were incubated for 30 min with 100  $\mu\text{g}/\text{ml}$  of human IgG. This was done to block any remaining, unbound protein A sites that might have otherwise reacted with the Fc portion of labeling antibodies. Bead controls were performed by incubating primary and secondary antibodies, as described, under conditions where no antigen (sLe<sup>X</sup> or 19.EK.Fc) was immobilized on the bead surface. Neutrophil controls were performed by incubating cells with FITC-labeled secondary antibody in the absence of primary antibody staining. Cells and beads were analyzed on a Becton Dickinson FACScan Flow Cytometer (Becton Dickinson, San Jose, CA). Histogram peak analysis was completed using WinMDI software (freeware from Scripps Research Institute FACS Core Facility, La Jolla, CA).

### Determination of carbohydrate and chimera site density

Flow cytometry was used to estimate adhesion molecule site densities on the surface of microspheres (Brunk and Hammer, 1997). Quantum 26 and Quantum 24 (Flow Cytometry Standards Corporation, San Juan, Puerto Rico) beads were used to create a calibration curve to relate the peak fluorescence intensity channel number to molecules of equivalent soluble fluorescence. Given the F/P ratio of the FITC-labeled secondary antibodies and assuming one-to-one binding between secondary and primary antibodies, as well as between primary antibody and antigen, the number of adhesion molecules on the surface of the beads could be calculated. This procedure was used to estimate site densities of multivalent sLe<sup>X</sup>, monovalent sLe<sup>X</sup>, and 19.EK.Fc on beads, as well as the site density of PSGL-1 on human neutrophils. Site densities of sLe<sup>X</sup> (mono- and multivalent) were determined using the HECA-452 mAb, and site densities of 19.EK.Fc and PSGL-1 were determined using the KPL1 mAb. Because the multivalent carbohydrate probes differ only in their terminal sugar residues, it is assumed that site densities determined for multivalent sLe<sup>X</sup> apply to multivalent sLe<sup>a</sup> and HSO<sub>3</sub>Le<sup>X</sup> probes for equivalent coating concentrations and incubation conditions.

### Laminar flow assays

A tapered-channel, parallel-plate flow chamber, similar to that described by Usami et al. (1993), was used for laminar flow assays. In the tapered-channel design, wall shear stress,  $\tau_w$ , varies linearly along the center axis of the flow chamber according to

$$\tau_w = \frac{6uQ}{h^2w_1} \left(1 - \frac{z}{L}\right)$$



where  $\mu$  is the fluid viscosity,  $Q$  is the volumetric flow rate,  $h$  is the channel height,  $w_1$  is the channel entrance width,  $L$  is the channel length, and  $z$  is the axial position from the inlet. The tapered channel template was cut from 0.01-inch-thick, reinforced Duralastic sheeting (Allied Biomedical, Goose Creek, SC) and was placed over slides coated with adhesion molecules. The slide and template were then placed in the bottom well of the flow chamber assembly, and the top was secured. The flow chamber was mounted on the stage of a Nikon Diaphot inverted microscope with phase-contrast optics (Nikon, Tokyo, Japan), and positions in the flow chamber were monitored using Nikon stage calipers (Nikon, Melville, NY). The chamber was flushed with perfusion buffer to remove air bubbles (DPBS<sup>+</sup> for experiments with beads and HBSS<sup>+</sup> for experiments with neutrophils), beads or cells were injected into an entrance reservoir, and flow was initiated with a syringe pump (Harvard Apparatus, South Natick, MA). Experiments were recorded with a Cohu black and white CCD camera (Cohu, San Diego, CA) and a Sony SVO-9500MD S-VHS recorder (Sony Medical Systems, Montvale, NJ). For each experiment, chamber height (gap width) and flow rate were measured to calculate the range of wall shear stresses obtained. Bead and cell interactions with the surface were observed along the center axis of the flow chamber and recorded for later analysis. For control studies without calcium, 5 mM EDTA was included in the DPBS<sup>+</sup> perfusion buffer.

## Data analysis

Bead and cell position measurements were obtained through digital image analysis of video records of adhesion experiments, using LabView software (National Instruments, Austin, TX) on a Gateway 2000 computer (Gateway 2000, Sioux City, SD). Instantaneous velocities and pause time distributions were analyzed using Matlab software (The Math Works, Natick, MA) on a Unix workstation (Silicon Graphics, Mountain View, CA). Rolling fluxes were determined by manually counting the number of rolling beads or cells within a field of view and dividing by the elapsed time, as indicated by a time stamp on video images, and viewing area (0.32 mm<sup>2</sup>). Only particles continuously rolling for at least 3 s were used in calculations of average rolling velocities. Average rolling velocities reported represent the mean velocity of at least 10 particles for every value of wall shear stress included. Instantaneous rolling velocity data was obtained every 30th of a second and was used to determine velocity variance,  $\sigma_v$ , and pause time distributions. Pause time distributions were obtained from position versus time data, where pauses were defined as periods of time during which instantaneous velocity was equal to zero. Average instantaneous rolling velocity,  $\langle V_{inst} \rangle$ , is an ensemble-averaged quantity, taken over a population of 10 rolling particles. Likewise, the velocity variance reported,  $\sigma_v$ , is an ensemble-averaged quantity, taken over the same 10 particles.

## RESULTS

### Comparison of sLe<sup>X</sup> and PSGL-1 expression on microspheres and neutrophils

To mimic the expression of carbohydrate groups on the surface of cells, biotinylated sLe<sup>X</sup> ligands or a truncated PSGL-1 chimera (19.EK.Fc) were immobilized on the surface of polystyrene beads precoated with either streptavidin (Superavidin) or protein A. Flow cytometry was then used to quantify the “expression level” of immobilized ligand. Fig. 2 shows representative fluorescence histograms indicating the amount of carbohydrate/chimera on bead surfaces, and Table 1 lists ligand site densities. Fig. 2 A shows fluorescence histograms obtained from beads incubated

with multivalent sLe<sup>X</sup> in a series of coating concentrations. Fig. 2 B displays the fluorescence shift due to beads coated with monovalent sLe<sup>X</sup> structures. A range of carbohydrate coating concentrations was examined, for both mono- and multivalent molecules, to try and match expression levels between beads and neutrophils, and between mono- and multivalent sLe<sup>X</sup>-coated beads. The values listed in Table 1 show that the amount of sLe<sup>X</sup> on beads coated with multivalent sLe<sup>X</sup> at 0.25  $\mu\text{g/ml}$  (92 sites/ $\mu\text{m}^2$ ) closely matches the level of sLe<sup>X</sup> on beads coated with monovalent sLe<sup>X</sup> at 5  $\mu\text{g/ml}$  (65 sites/ $\mu\text{m}^2$ ). Fig. 2 C shows the results of HECA-452 labeling of human neutrophils. As indicated by the values in Table 1, at the highest coating concentration of sLe<sup>X</sup> used (0.5  $\mu\text{g/ml}$ ), the site density of sLe<sup>X</sup> on beads was similar to that found on human neutrophils. Labeling experiments performed with other anti-sLe<sup>X</sup> antibodies (CSLEX-1 and KM-93) produced similar results (data not shown).

Surface densities of 19.EK.Fc immobilized on protein A-coated beads and PSGL-1 on human neutrophils were also measured. Fig. 2, D and E, shows typical fluorescence histograms obtained. As with sLe<sup>X</sup>, a range of 19.EK.Fc coating concentrations was examined, to try to match the physiological expression of the full-length molecule on human neutrophils. Before using PSL275 to label PSGL-1 epitopes, we attempted to identify the number of sLe<sup>X</sup> groups on these beads by staining with HECA-452. However, HECA-452 showed no reactivity against the 19.EK.Fc chimera. Because the chimera was produced in Chinese hamster ovary cells, it may possess slight variations in glycosylation when compared to human forms of the same molecule. As a result, such ligands may retain their adhesive properties but may not be recognizable to monoclonal antibodies raised against the human form of particular carbohydrate epitopes.

### Carbohydrate-coated microspheres bind specifically, under flow conditions, to P-selectin

The specificity of interaction between sLe<sup>X</sup>-coated beads and P-selectin surfaces was examined by quantifying bead rolling fluxes. Fig. 3 shows results of rolling flux measurements on surfaces coated with 10  $\mu\text{g/ml}$  of sP-selectin. In all experiments, nonspecific, firm adhesion was so low as to be nearly undetectable. Radioactive binding studies indicated a site density of  $181 \pm 36$  sites/ $\mu\text{m}^2$  for this coating concentration. Adhesion of beads coated with multivalent forms of sLe<sup>X</sup>, sLe<sup>a</sup>, HSO<sub>3</sub>Le<sup>X</sup>, or Le<sup>X</sup> was examined. sLe<sup>X</sup>- and sLe<sup>a</sup>-coated beads showed similar rolling fluxes, both of which were slightly greater than that seen with beads coated with HSO<sub>3</sub>Le<sup>X</sup>. Beads coated with the Le<sup>X</sup> carbohydrate did not interact with sP-selectin surfaces. As a positive control, sLe<sup>X</sup>-coated beads were infused over a surface that was incubated with anti-E-selectin mAb (20  $\mu\text{g/ml}$ ) after the adsorption of sP-selectin and blocking with BSA. As shown, anti-E-selectin antibody had no effect on the rolling flux of sLe<sup>X</sup>-coated beads. Negative controls included in-

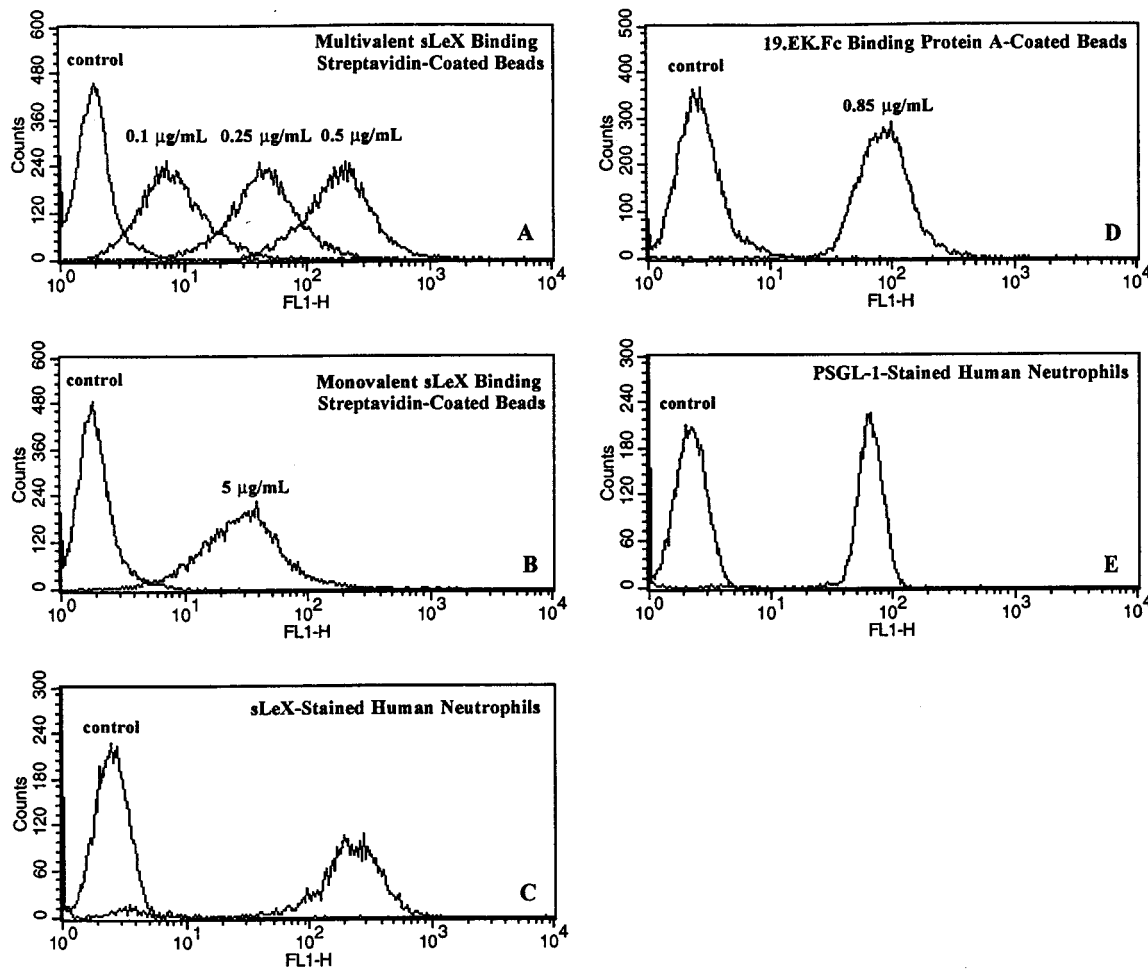

FIGURE 2 Fluorescence histograms of ligand-coated beads obtained by flow cytometry. (A–C) HECA-452 binding to sLe<sup>X</sup> epitopes. (A) Streptavidin-coated beads with 0, 0.1, 0.25, and 0.5 µg/ml multivalent sLe<sup>X</sup>. (B) Streptavidin-coated beads with 0 and 5 µg/ml monovalent sLe<sup>X</sup>. (C) Human neutrophils. (D and E) PSL275 binding PSGL-1 epitopes on chimera-coated protein A beads or human neutrophils. (D) Protein A-coated beads with 0 and 0.85 µg/ml 19.EK.Fc chimera. (E) Human neutrophils.

fusion of beads coated with D-biotin over an sP-selectin surface, infusion of sLe<sup>X</sup>-coated beads over a surface treated only with BSA blocking solution, infusion of sLe<sup>X</sup>-coated beads over an sP-selectin surface blocked with an anti-P-selectin mAb (20 µg/mL) before bead infusion, and inclusion of 5 mM EDTA in the perfusion buffer. All such treatments were equally successful in abolishing bead-surface interactions.

### Rolling dynamics are influenced by carbohydrate structure, number of adhesion receptors, number of ligands, and ligand valency

In addition to rolling fluxes, rolling velocities of beads coated with sLe<sup>X</sup>, sLe<sup>a</sup>, and HSO<sub>3</sub>Le<sup>X</sup> were calculated. Beads were coated with equal concentrations (0.5 µg/ml) of multivalent, carbohydrate probes and perfused over identical sP-selectin surfaces, coated at 10 µg/ml. Rolling veloc-

ities, as a function of wall shear stress, are shown in Fig. 4. HSO<sub>3</sub>Le<sup>X</sup>-coated beads showed significantly faster rolling dynamics than sLe<sup>X</sup>- or sLe<sup>a</sup>-coated beads at all values of wall shear stress examined. A stress of 2 dynes/cm<sup>2</sup> was the highest wall shear stress at which HSO<sub>3</sub>Le<sup>X</sup>-coated beads could maintain stable rolling interaction with the surface for at least 3 s. In contrast, both sLe<sup>X</sup>- and sLe<sup>a</sup>-coated beads were able to maintain stable rolling interactions up to ~4 dynes/cm<sup>2</sup>. sLe<sup>X</sup>- and sLe<sup>a</sup>-coated beads showed comparable rolling dynamics at low values of wall shear stress, while sLe<sup>X</sup>-coated beads showed slightly faster rolling velocities at higher values of wall shear stress.

Adhesion dynamics were found to be sensitive to both the number of adhesion receptors on the surface and the number of ligand groups immobilized on the beads. Fig. 5 A shows the results of a series of experiments in which the surface density of sP-selectin was systematically varied. Populations of beads with a constant number of ligand groups

**TABLE 1** Site densities of bead-immobilized and cell surface ligands

Ligand	Sites/ $\mu\text{m}^2$
HECA-452-labeled multivalent sLe <sup>x</sup>	
0.5 $\mu\text{g}/\text{ml}$ sLe <sup>x</sup>	214
0.25 $\mu\text{g}/\text{ml}$ sLe <sup>x</sup>	92
0.1 $\mu\text{g}/\text{ml}$ sLe <sup>x</sup>	17
HECA-452-labeled monovalent sLe <sup>x</sup>	
5 $\mu\text{g}/\text{ml}$ sLe <sup>x</sup>	65
HECA-452-labeled human neutrophils	414
KPL1-labeled 19.EK.Fc	
0.85 $\mu\text{g}/\text{ml}$ 19.EK.Fc	384
0.12 $\mu\text{g}/\text{ml}$ 19.EK.Fc	144
KPL1-labeled human neutrophils	48

Saturating concentrations of both primary and secondary antibodies were used to measure sLe<sup>x</sup>, 19.EK.Fc, and PSGL-1 site densities. sLe<sup>x</sup> densities were determined using HECA-452, and 19.EK.Fc and PSGL-1 site densities were determined using KPL1. Diameters of Superavidin beads, protein A beads, and human neutrophils are 10.9, 10.4, and 8.5  $\mu\text{m}$ , respectively.

(multivalent sLe<sup>x</sup> coated at 0.5  $\mu\text{g}/\text{ml}$ ) were then perfused over the different surfaces. sP-selectin coating concentrations used for these experiments were 10, 5, and 1  $\mu\text{g}/\text{ml}$ , corresponding to  $181 \pm 36$ ,  $46 \pm 35$ , and  $3 \pm 3$  sites/ $\mu\text{m}^2$ , as determined by radiolabeled, anti-P-selectin antibody

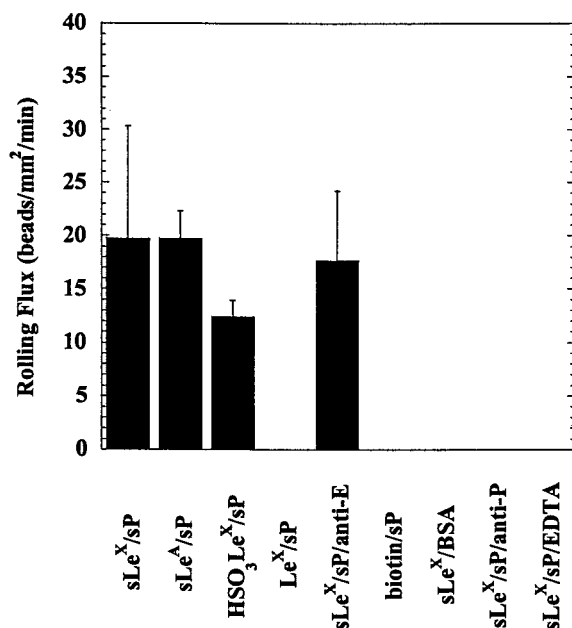

**FIGURE 3** Rolling bead flux on P-selectin. Rolling flux measurements for variously treated beads, surfaces, and experimental conditions at an average wall shear stress of 0.55 dynes/cm<sup>2</sup>. x axis labels describe bead coating/surface coating/other perfusion buffer additives. Multivalent sLe<sup>x</sup> was used for all control experiments. sP-selectin (10  $\mu\text{g}/\text{ml}$ ) (181 sites/ $\mu\text{m}^2$ ) was used for all measurements.

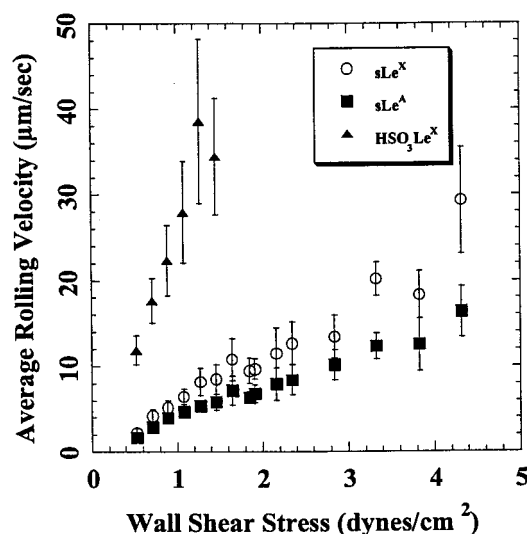

**FIGURE 4** Rolling velocity as a function of wall shear stress for various carbohydrate ligands (sLe<sup>x</sup>, sLe<sup>a</sup>, and HSO<sub>3</sub>Le<sup>x</sup>) on P-selectin. Microspheres were coated with 0.5  $\mu\text{g}/\text{ml}$  of multivalent ligand, and surfaces were coated with 10  $\mu\text{g}/\text{ml}$  sP-selectin.  $\circ$ , sLe<sup>x</sup>;  $\blacksquare$ , sLe<sup>a</sup>;  $\blacktriangle$ , HSO<sub>3</sub>Le<sup>x</sup>.

binding studies. At the lowest site densities used (3 sites/ $\mu\text{m}^2$ ), sP-selectin surfaces supported very low levels of steadily rolling beads, and beads were unable to maintain steady rolling interactions above  $\sim 1$  dynes/cm<sup>2</sup> for 3 s or more. A parallel set of experiments was conducted in which the density of sP-selectin on the surface was fixed (10  $\mu\text{g}/\text{ml}$  coating) and the amount of bead-immobilized carbohydrate (multivalent sLe<sup>x</sup>) was varied. sLe<sup>x</sup> coating concentrations used for these experiments were 0.5, 0.25, and 0.1  $\mu\text{g}/\text{ml}$ , corresponding to 214, 92, and 17 sites/ $\mu\text{m}^2$ . Fig. 5 B shows the dependence of rolling velocity on the density of immobilized carbohydrate ligand. As expected, our results demonstrate that increasing the number of adhesion molecules, on either side of the contact zone (bead or surface), facilitates the formation of additional adhesion bonds and hence retards the motion of rolling beads.

The influence of ligand valency on the dynamics of adhesion was also examined. Two sets of sLe<sup>x</sup>-coated beads were prepared: one with a multivalent form of biotinylated sLe<sup>x</sup> and one with a monovalent form of the same molecule. To examine the effects of ligand valency, without artifacts due to differences in absolute numbers of sLe<sup>x</sup> groups, coating concentrations of each probe (multi- and monovalent) were titrated to deliver approximately equal numbers of surface sLe<sup>x</sup> groups. Fig. 2, A and B, and Table 1 show that coating beads with 0.25  $\mu\text{g}/\text{ml}$  of multivalent sLe<sup>x</sup> and 0.5  $\mu\text{g}/\text{ml}$  of monovalent sLe<sup>x</sup> yielded site densities with the closest agreement (multi = 92 sites/ $\mu\text{m}^2$ , mono = 65 sites/ $\mu\text{m}^2$ ). Fig. 6 shows a comparison of rolling velocities of beads coated with multivalent and monovalent sLe<sup>x</sup>, as described. At similar site densities, both mono- and multivalent sLe<sup>x</sup> support rolling adhesion on P-selectin, with the monovalent form supporting only slightly faster rolling.

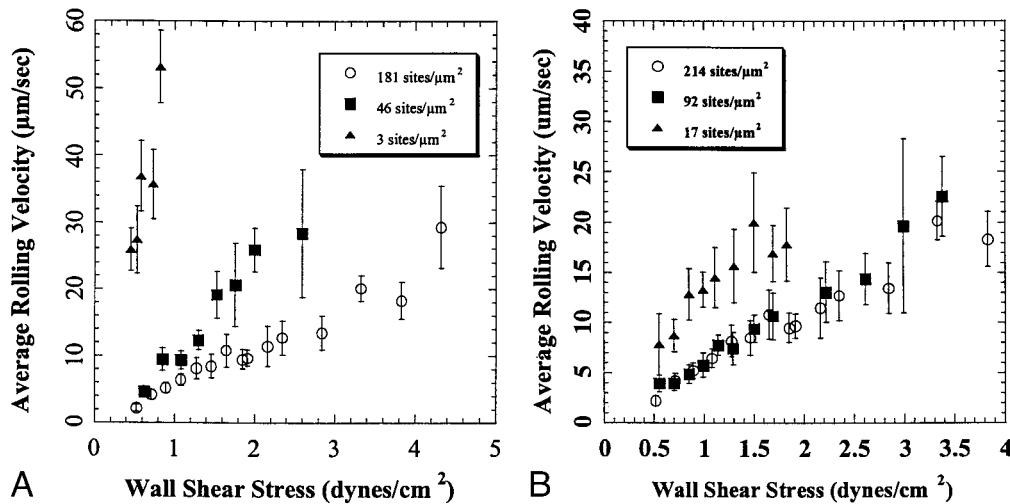

FIGURE 5 Rolling velocity as a function of wall shear stress for sLe<sup>X</sup> on P-selectin, with varying receptor and ligand density. (A) Variation in bead rolling velocities due to differences in the number of adsorbed sP-selectin receptors. Measurements were completed with beads coated with 214 sites/µm<sup>2</sup> of multivalent sLe<sup>X</sup>. ○, 181 sites/µm<sup>2</sup>; ■, 46 sites/µm<sup>2</sup>; ▲, 3 sites/µm<sup>2</sup>. (B) Variation in bead rolling velocities due to differences in the number of immobilized, multivalent sLe<sup>X</sup> ligands. Measurements were completed with surfaces coated with 181 sites/µm<sup>2</sup> sP-selectin. ○, 214 sites/µm<sup>2</sup>; ■, 92 sites/µm<sup>2</sup>; △, 17 sites/µm<sup>2</sup>.

### Comparison of truncated PSGL-1-mediated, sLe<sup>X</sup>-mediated, and neutrophil adhesion

Fig. 7 *A* shows a comparison of rolling dynamics among beads coated with different concentrations of 19.EK.Fc and multivalent sLe<sup>X</sup>. As with sLe<sup>X</sup>-coated beads, rolling dynamics of chimera-coated beads show sensitivity to the amount of ligand immobilized on the bead. Beads coated with 0.12 µg/ml of 19.EK.Fc (144 sites/µm<sup>2</sup>) displayed

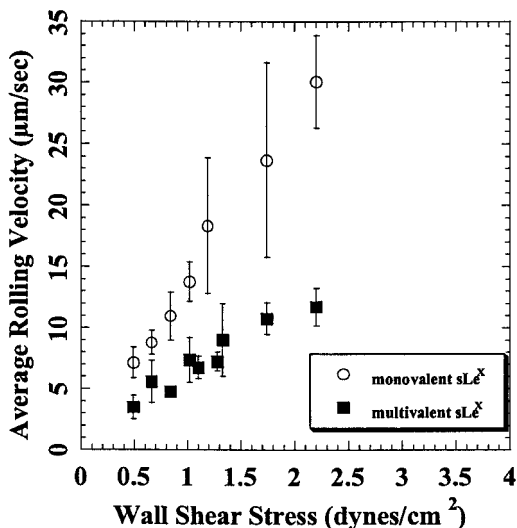

FIGURE 6 Comparison of adhesion dynamics between beads coated with multivalent and monovalent sLe<sup>X</sup>. Superavidin beads coated with either 0.25 µg/ml multivalent sLe<sup>X</sup> (92 sites/µm<sup>2</sup>) or 5 µg/ml monovalent sLe<sup>X</sup> (65 sites/µm<sup>2</sup>) were perfused over surfaces coated with 10 µg/ml sP-selectin. ○, monovalent; ■, multivalent.

rolling velocities similar to that seen with beads coated with 0.5 µg/ml sLe<sup>X</sup> (214 sites/µm<sup>2</sup>). A coating concentration of 0.85 µg/ml 19.EK.Fc (384 sites/µm<sup>2</sup>) yielded higher ligand expression and hence significantly slower rolling velocities. At such concentrations, the sensitivity of rolling velocity to changes in wall shear stress is also seen to be greatly reduced. Fig. 7 *B* shows rolling velocities of sLe<sup>X</sup>-coated microspheres (0.5 µg/ml), 19.EK.Fc-coated beads (0.85 µg/ml), and human neutrophils on P-selectin surfaces. Adhesion experiments with sLe<sup>X</sup>- and chimera-coated beads were performed on 10 µg/ml sP-selectin, and experiments with neutrophils were completed on surfaces coated with either 10 or 0.5 µg/ml sP-selectin. On surfaces coated with 10 µg/ml of sP-selectin, neutrophils showed rolling dynamics that were significantly slower than that of sLe<sup>X</sup>-coated beads. However, rolling dynamics of beads coated with 19.EK.Fc chimera closely approximated the behavior of neutrophils on these surfaces. At a much lower concentration of sP-selectin (0.5 µg/ml), neutrophil rolling velocities were similar to those seen with sLe<sup>X</sup>-coated beads rolling on the higher (10 µg/ml) concentration of sP-selectin. Surfaces coated with 0.5 µg/ml sP-selectin were unable to support any level of sLe<sup>X</sup>-coated bead adhesion.

### Instantaneous velocity traces and pause time distributions

For another comparison of rolling dynamics among the different carbohydrate probes studied, as well as between beads and cells, instantaneous rolling velocities of ligand-coated beads and neutrophils on sP-selectin were examined. Fig. 8 shows representative instantaneous rolling velocity



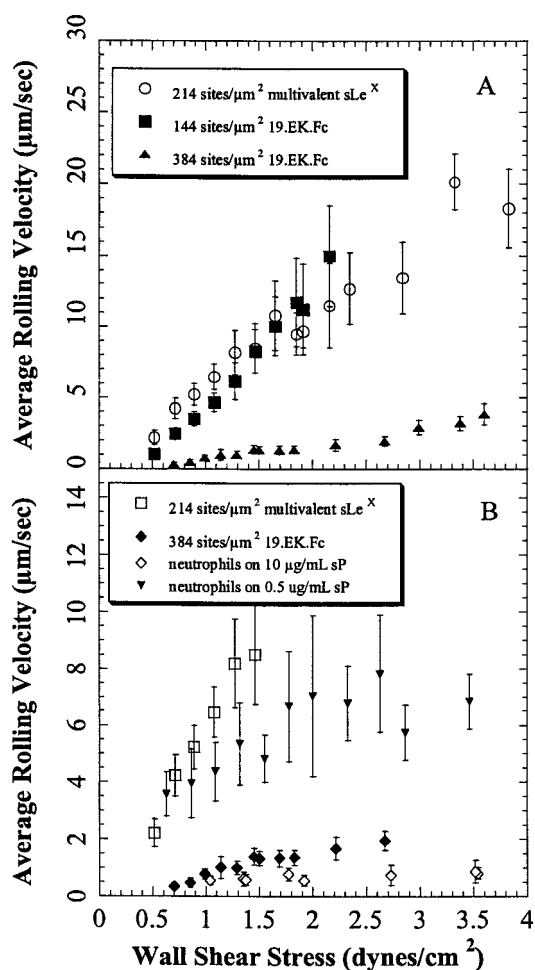

FIGURE 7 Comparison of sLe<sup>X</sup> and 19.EK.Fc adhesion to sP-selectin. (A) Rolling velocities of beads coated with multivalent sLe<sup>X</sup> (0.5 μg/ml) or two different concentrations of 19.EK.Fc chimera (0.85 μg/ml and 0.12 μg/ml) on 10 μ/ml sP-selectin. ○, 214 sites/μm<sup>2</sup> multivalent sLe<sup>X</sup>; ■, 144 sites/μm<sup>2</sup> 19.EK.Fc; ▲, 384 sites/μm<sup>2</sup> 19.EK.Fc. (B) Adhesive behavior of neutrophils in comparison to that obtained with multivalent sLe<sup>X</sup> (0.5 μg/ml)-coated and 19.EK.Fc (0.85 μg/ml)-coated microspheres. Neutrophils were perfused over sP-selectin surfaces coated at either 10 μg/ml or 0.5 μg/ml. 19.EK.Fc-coated and sLe<sup>X</sup>-coated beads were perfused over sP-selectin surfaces coated at 10 μg/ml. □, 214 sites/μm<sup>2</sup> multivalent sLe<sup>X</sup>; ◆, 384 sites/μm<sup>2</sup> 19.EK.Fc; ◇, neutrophils on 10 μg/ml sP-selectin; ▼, neutrophils on 0.5 μg/ml sP-selectin.

traces for the beads and cells examined (Fig. 8, A–E) and the associated pause time distributions (Fig. 8, *i–v*). Bead measurements were performed on surfaces coated with 10 μg/ml sP-selectin and neutrophil measurements on surfaces coated with 0.5 μg/ml sP-selectin. A distinguishing characteristic of all instantaneous rolling velocity plots is the “noisy” appearance of the data. This feature reflects the probabilistic nature of the breakage of adhesion bonds under applied forces. Table 2 lists average instantaneous rolling velocities,  $\langle V_{inst} \rangle$ , and associated variance,  $\sigma_V$ , for the populations of beads shown. As previously shown for E- and L-selectin/carbohydrate interactions (Brunk et al., 1996;

Brunk, 1997), a monotonic increase in the variance,  $\sigma_V$ , and the average velocity,  $\langle V_{inst} \rangle$ , is evident. From instantaneous velocity data, bead-cell pause time distributions were obtained. Pause time distributions represent pauses due to an ensemble of adhesion bonds and therefore cannot be directly related to single bond kinetic and mechanical properties without substantial theoretical analysis. While ample numbers of low-affinity carbohydrate ligands for P-selectin clearly yield rolling adhesive interactions on P-selectin surfaces, single carbohydrate/P-selectin bonds were unable to support pausing/tethering under flow. A quantitative comparison of means of the pause time distributions for the various P-selectin ligands is also shown in Table 2. Mean pause times indicate that HSO<sub>3</sub>Le<sup>X</sup>-coated beads, which display the fastest rolling dynamics of all ligands studied, have few pausing interactions, each of short duration, with the sP-selectin surface. In contrast, beads coated with the 19.EK.Fc chimera show a greater number of pausing interactions, for longer duration, with the surface. As expected, based upon average rolling velocity data reported earlier, pause time distributions for sLe<sup>X</sup>- and sLe<sup>a</sup>-coated beads appear very similar. Because of the lower surface concentration of sP-selectin used for neutrophil data (0.5 μg/ml), neutrophil pause times appear similar to those obtained using beads coated with sLe<sup>X/a</sup>. Thus the difference in affinity between the full-length PSGL-1 expressed by neutrophils and the carbohydrates expressed on the beads is seen to be counterbalanced by the difference in surface concentration of sP-selectin. This finding reflects the sensitivity of pause time data to the number of adhesion bonds involved in the interaction.

## DISCUSSION

Previous work in our laboratory has shown that beads coated with sLe<sup>X</sup> and related structures (sLe<sup>a</sup>, HSO<sub>3</sub>Le<sup>X</sup>), under flow conditions, can bind to and roll on surfaces coated with either E- or L-selectin (Brunk and Hammer, 1997; Brunk, 1997). In these studies, a cell-free system was used to completely specify adhesion chemistry and clearly identify and characterize carbohydrate ligands for both E- and L-selectin. To more closely examine molecular requirements for adhesion to P-selectin, we used a similar approach in which carbohydrate-coated beads were perfused over P-selectin surfaces. The sialomucin ligand PSGL-1 has been identified as the high-affinity leukocyte counter receptor for P-selectin and reportedly depends on the presence of N-terminal tyrosine sulfate moieties for complete binding activity (Pouyani and Seed, 1995). We have shown that sLe<sup>X</sup>, a concise element of the more complex recognition that is involved in the binding of PSGL-1, is capable of mediating adhesive interactions with P-selectin. Thus we find that under flow conditions tyrosine sulfation is not required for functional recognition of P-selectin. Rather, its presence



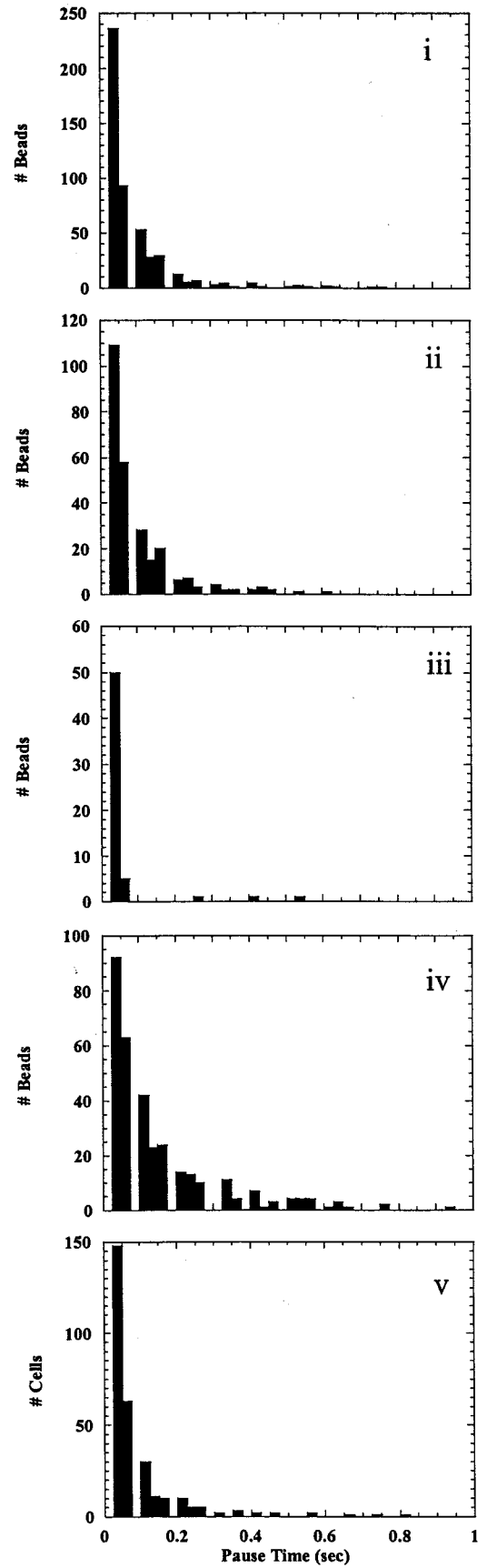
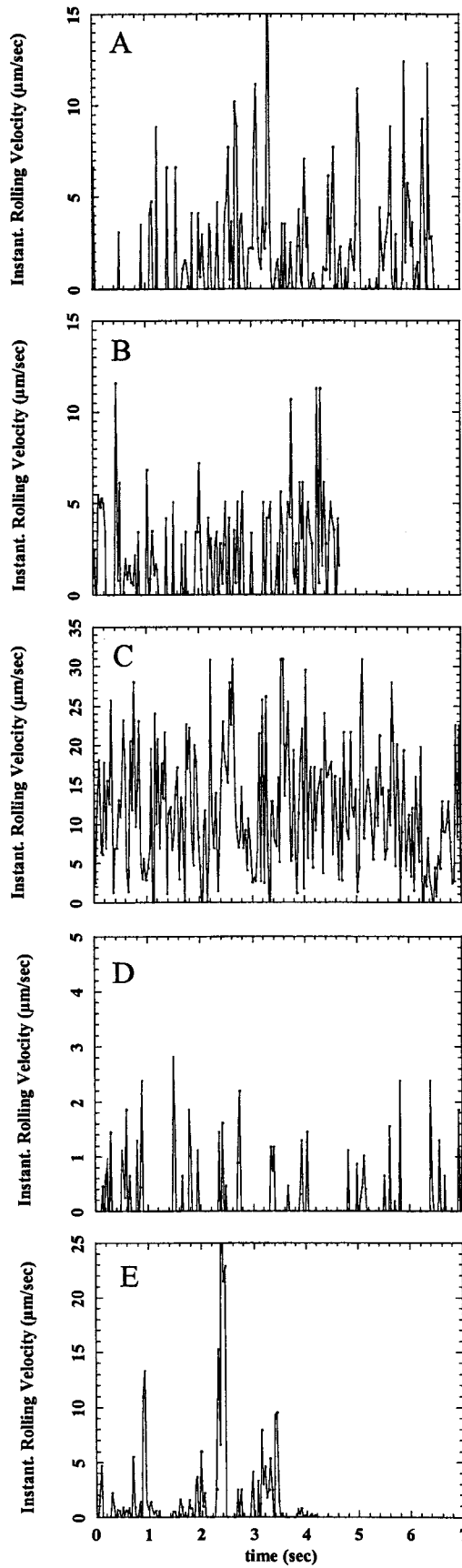

**TABLE 2** Ensemble-averaged, instantaneous rolling velocity parameters

	$\langle V_{\text{inst}} \rangle$ ( $\mu\text{m/s}$ )	$\sigma_v$ ( $\mu\text{m}^2/\text{s}^2$ )	Mean pause time (s)
sLe <sup>X</sup>	1.85	10.48	0.095
sLe <sup>A</sup>	1.59	7.22	0.099
H <sub>2</sub> SO <sub>3</sub> Le <sup>X</sup>	12.28	97.79	0.055
19.EK.Fc	0.42	1.34	0.184
Neutrophils	2.60	34.15	0.094

Values reported correspond to instantaneous rolling velocity data shown in Fig. 8. Data were collected at an average wall shear stress of 0.53 dynes/cm<sup>2</sup> for 10 rolling cells (for each ligand studied), acquired at 30 frames/s.

appears to strengthen interactions between sLe<sup>X</sup> and P-selectin.

As found with E- and L-selectin, the Le<sup>X</sup> trisaccharide showed no adhesion to P-selectin surfaces. However, with additional sialylation (sLe<sup>X</sup>, sLe<sup>a</sup>) or sulfation (H<sub>2</sub>SO<sub>3</sub>Le<sup>X</sup>), rolling adhesion was restored. Beads coated with either mono- or multivalent sLe<sup>X</sup> exhibited rolling interactions on P-selectin surfaces, the dynamics of which were sensitive to both receptor and ligand density, as well as to wall shear stress. Thus multivalency of the selectin ligand is not required for rolling on P-selectin. For the density of monovalent sLe<sup>X</sup> used (65 sites/ $\mu\text{m}^2$ ), we estimate the intramolecular spacing to be  $\sim 140$  nm, suggesting that the ligand is not pseudomonovalent. Compared to data obtained for both E- and L-selectin, rolling fluxes of carbohydrate-coated beads on P-selectin appear to be of the same order of magnitude. This indicates that the three selectins are equally capable of interacting with simple, sLe<sup>X</sup>-like carbohydrates. Rolling velocities on E-selectin surfaces show magnitudes similar to those obtained on P-selectin, while rolling velocities on L-selectin surfaces are significantly faster (on the order of  $\sim 100$   $\mu\text{m/s}$ ). Furthermore, in contrast to L-selectin, carbohydrate-coated beads rolling on E- (and now P-) selectin did not exhibit any shear-threshold effects (Brunk, 1997; Greenberg et al., manuscript submitted for publication) in which the rolling flux goes through a maximum with increasing shear rate.

We also compared the adhesion of carbohydrate-coated spheres to that mediated by high-affinity P-selectin ligands. This was done by examining the adhesion of both neutrophils and of beads coated with a chimeric protein (19.EK.Fc) containing the N-terminal, 19 amino acid sequence of PSGL-1. These recombinant peptides are heterogeneously sulfated and glycosylated and possess the essential information content of the full-length PSGL-1 molecule (Goetz et al., 1997; Sako et al., 1995). The greater affinity of 19.EK.Fc for P-selectin is evident from the low

rolling velocities that can be achieved with beads coated with this molecule. That the 19.EK.Fc chimera captures the essential features of the full-length PSGL-1 ligand is seen by the similar rolling velocities obtained with neutrophils rolling on an identical sP-selectin surface (10  $\mu\text{g/ml}$ ). On a lower concentration of sP-selectin (0.5  $\mu\text{g/ml}$ ), neutrophils rolled with velocities similar to those of carbohydrate-coated beads on higher densities (10  $\mu\text{g/ml}$ ) of sP-selectin. Our results demonstrate that although they are sensitive to adhesion molecule site density, high- and low-affinity ligands can indeed yield similar adhesive behavior. This effect is also seen with molecules that mediate binary adhesion rather than rolling (Swift et al., 1998).

An interesting and puzzling effect we observed was how ligand (bead) or receptor (surface) molecular density influenced adhesion dynamics. Using sLe<sup>X</sup>-coated beads and sP-selectin-coated surfaces, at approximately the same molecular density, we found that rolling velocity was much more sensitive to changes in sP-selectin density (Fig. 5 A) than to changes in sLe<sup>X</sup> density (Fig. 5 B). This effect was also seen in sLe<sup>X</sup>-mediated rolling on E-selectin (Brunk and Hammer, 1997). Perhaps when ligand or receptor density is limiting, small changes in expression lead to larger changes in adhesion. In this case, we see that increases in sP-selectin site density improve adhesion, while increases in sLe<sup>X</sup> site density, beyond a certain point, do not. The fact that sLe<sup>X</sup> is presented on a kinematically mobile surface may influence the adhesion observed in ways that should be examined more closely, using techniques such as the adhesive dynamics algorithm developed in our laboratory (Hammer and Apte, 1992).

In an attempt to examine the kinetic and mechanical properties of P-selectin/carbohydrate bonds, we analyzed instantaneous rolling velocity data. Such data have been used to obtain tethering or pause time information, from which unstressed kinetic off-rates can be obtained (Alon et al., 1997; Chen and Springer, 1999; Smith et al., 1999). By completing experiments at different values of wall shear stress, bond mechanical properties can also be extracted. Such analysis fails when low-affinity selectin/carbohydrate bonds are examined using beads. A density of sP-selectin of 3 sites/ $\mu\text{m}^2$  (1  $\mu\text{g/ml}$ ) was the lowest density for which adhesive interactions were observed, and at this concentration beads continued to show rolling interactions with the surface. Distance versus time data, taken at these conditions, at both 30 and 250 frames/s, showed no signs of quantal tethering. We believe that it will not be possible to measure quantal tethering with beads, because of a short lever arm, which results in forces on molecules that are too great to

**FIGURE 8** Instantaneous rolling velocity traces and pause time distributions. (A–E) Instantaneous rolling velocities as a function of time for sLe<sup>X</sup>-, sLe<sup>A</sup>-, H<sub>2</sub>SO<sub>3</sub>Le<sup>X</sup>-, and 19.EK.Fc-coated beads, and neutrophils, respectively. Data was acquired at 30 frames/s. (i–v) Pause time distributions corresponding to instantaneous rolling velocities. Measurements were made at an average wall shear stress of 0.53 dynes/cm<sup>2</sup> on surfaces coated with 10  $\mu\text{g/ml}$  (sLe<sup>X</sup>-, sLe<sup>A</sup>-, H<sub>2</sub>SO<sub>3</sub>Le<sup>X</sup>-, and 19.EK.Fc-coated beads) or 0.5  $\mu\text{g/ml}$  (neutrophils) sP-selectin.

permit single bonds to survive for a measurable length of time. This conclusion is supported by recent simulations in our laboratory of bead tethering using adhesive dynamics algorithms (data not shown). Pause time data reported here represent behavior due to an ensemble of adhesion bonds. The presence of multiple bonds, the loading of which is distributed and breakage probabilistic (Chang and Hammer, 1996; Tees et al., 1993), prohibits extrapolation of our data to single-bond parameters, such as the off-rate and reactive compliance (Alon et al., 1995; Smith et al., 1999). Other force probe techniques, such as atomic force microscopy, the biomembrane force probe (Evans et al., 1995), or microcantilever techniques (Hwang and Waugh, 1997), are likely better suited for the measurement of single bond properties. However, our results provide interesting insights into the dynamics of rolling adhesion mediated by the carbohydrates studied. As seen in Fig. 8 and Table 2, ligands for P-selectin display the following order of decreasing strength of adhesion: 19.EK.Fc > sLe<sup>a</sup> ~ sLe<sup>X</sup> > HSO<sub>3</sub>Le<sup>X</sup>. Likewise, the variance in instantaneous rolling velocity is seen to increase in the same order as the decreasing strength of adhesion. Interestingly, the means of the stop-time distributions also follow the same trend (Fig. 8, *i-v*). While sLe<sup>X</sup> and sLe<sup>a</sup> can provide the essential quantitative features of rolling, the addition of sulfation (as with 19.EK.Fc) clearly reduces the rolling velocity, decreases the variance of rolling, and shifts the stop time distributions to the right. In fact, it is only with the 19.EK.Fc ligands that bead rolling dynamics come to closely resemble the quantitative features seen with neutrophils on P-selectin.

The results we present appear to be different from the findings of other investigators who have shown the abrogation or even the elimination of P-selectin binding, in both static and flow assays, after the elimination of sulfate moieties from PSGL-1 (DeLuca et al., 1995; Liu et al., 1998; Pouyani and Seed, 1995). Even after such treatment, sLe<sup>X</sup> is still expected to be present on the PSGL-1 molecule and, based upon our findings, would be expected to support adhesion to P-selectin. Static binding of 19.EK.Fc, containing no tyrosine sulfate, to P-selectin, has been observed (Sako et al., 1995). Whether this is due to sLe<sup>X</sup> alone or in tandem with other PSGL-1 epitopes is unclear. In contrast, a recent study examining PSGL-1 adhesive determinants highlights the importance of the dual presentation of both sLe<sup>X</sup> and sulfated tyrosine for high-affinity binding to P-selectin (Leppanen et al., 1999). The absence of either sLe<sup>X</sup> or tyrosine sulfate renders the binding of a synthetic PSGL-1 glycopeptide undetectable in equilibrium binding assays. The synthetic peptide was also able to successfully inhibit the binding of neutrophils to P-selectin surfaces in static adhesion assays. sLe<sup>X</sup>/P-selectin adhesion under flow was not addressed in either case. Receptor and/or ligand site densities may partially explain differences seen, although we have attempted to account for this effect in our studies

by quantifying adhesion molecule “expression levels” and matching with levels on neutrophils and endothelium. sLe<sup>X</sup> expression on beads and neutrophils showed comparable levels, and site densities of surface-bound P-selectin were found to be comparable to those used in similar experiments with neutrophils (Lawrence and Springer, 1991; Moore et al., 1995; Patel and McEver, 1997). As an alternative explanation, perhaps the absence of sulfate groups on PSGL-1 may in some way affect the conformation of the molecule when expressed on cells, rendering terminal sLe<sup>X</sup> groups unavailable for binding. However, based on our findings, one must conclude that sLe<sup>X</sup> itself, without the assistance of sulfation, is fully capable of supporting rolling adhesion on P-selectin.

While shedding light on the relative role of glycosylation and tyrosine sulfation in P-selectin adhesion, this work may also have implications for tumor biology. Observations of P-selectin-dependent platelet/tumor (Karparkin and Pearlstein, 1981; Kim et al., 1999; Stone and Wagner, 1993) and tumor/endothelial adhesion underscore the importance of selectin-carbohydrate interactions in tumor pathology. Although explicit data are lacking, indirect evidence suggests that low-affinity, P-selectin interactions may be operative in tumor metastasis (Fukuda, 1996; Goetz et al., 1996b; Krause and Turner, 1999; Pottratz et al., 1996). In addition to their presence on PSGL-1, sLe<sup>X</sup> as well as sLe<sup>a</sup> epitopes are aberrantly expressed in great abundance on many human tumor cells, especially carcinomas (Fukushima et al., 1984; Hakamori, 1996; Magnani et al., 1982). Adhesive interactions between these carbohydrates and E-selectin have been well documented. Adhesion of sLe<sup>X/a</sup>-expressing metastatic cells to P-selectin would be consistent with the findings reported herein. Such interactions may facilitate the deposition of metastatic tumor cells in two ways. P-selectin expressed on the surface of platelets could bind to sLe<sup>X</sup> and sLe<sup>a</sup> antigens on tumor cells, accelerating the formation of large, multicellular aggregates capable of embolizing in small vessels (Kim et al., 1998; Krause and Turner, 1999; Stone and Wagner, 1993). In a more direct manner, sLe<sup>X</sup> and sLe<sup>a</sup> antigens on tumor cells could bind endothelial P-selectin, facilitating the arrest of circulating tumor cells. The relationship between the activity of these carbohydrates and their glycoprotein environment has not been investigated. Whether additional *cis* elements on a glycoprotein backbone are necessary for P-selectin binding activity is not known. Our findings suggest that further characterization of tumor carbohydrate–P-selectin interactions is warranted and may add insight to the design of antimetastatic therapies.

The authors gratefully acknowledge the support of the National Institutes of Health (HL 18208) to DAH and a NASA (Graduate Student Researchers Program) predoctoral fellowship to SDR.

## REFERENCES

- Alon, R., S. Chen, K. D. Puri, E. B. Finger, and T. A. Springer. 1997. The kinetics of L-selectin tethers and the mechanics of selectin-mediated rolling. *J. Cell Biol.* 138:1169–1180.
- Alon, R., D. A. Hammer, and T. A. Springer. 1995. Lifetime of the P-selectin-carbohydrate bond and its response to tensile force in hydrodynamic flow. *Nature.* 374:539–542.
- Berg, E. L., J. Magnani, R. A. Warnock, M. K. Robinson, and E. C. Butcher. 1992. Comparison of L-selectin and E-selectin ligand specificities: the L-selectin can bind the E-selectin ligands sialyl Le<sup>x</sup> and sialyl Le<sup>a</sup>. *Biochem. Biophys. Res. Commun.* 184:1048–1055.
- Berg, E. L., M. K. Robinson, O. Mansson, E. C. Butcher, and J. L. Magnani. 1991. A carbohydrate domain common to both sialyl Le<sup>a</sup> and sialyl Le<sup>x</sup> is recognized by the endothelial cell leukocyte adhesion molecule ELAM-1. *J. Biol. Chem.* 266:14869–14872.
- Brunk, D. K. 1997. Selectin-carbohydrate adhesion under flow using a cell-free system. Ph.D. thesis. Cornell University, Ithaca, NY.
- Brunk, D. K., D. J. Goetz, and D. A. Hammer. 1996. Sialyl Lewis X/E-selectin-mediated rolling in a cell-free system. *Biophys. J.* 71:2902–2907.
- Brunk, D. K., and D. A. Hammer. 1997. Quantifying rolling adhesion with a cell-free assay: E-selectin and its carbohydrate ligands. *Biophys. J.* 72:2820–2833.
- Chang, K.-C. 1996. Adhesive dynamics simulation of receptor-mediated cell adhesion on surfaces under flow. Ph.D. thesis. Cornell University, Ithaca, NY.
- Chang, K.-C., and D. A. Hammer. 1996. Influence of direction and type of applied force on the detachment of macromolecularly-bound particles from surfaces. *Langmuir.* 12:2271–2282.
- Chen, S., and T. A. Springer. 1999. An automatic braking system that stabilizes leukocyte rolling by an increase in selectin bond number with shear. *J. Cell Biol.* 144:185–200.
- DeLuca, M., M. Dunlop, R. K. Andrews, and J. V. J. Flannery. 1995. A novel cobra venom metalloproteinase, mocarhagin, cleaves a 10-amino acid peptide from the mature N terminus of P-selectin glycoprotein ligand receptor, PSGL-1, and abolishes P-selectin binding. *J. Biol. Chem.* 270:26734–26737.
- Evans, E., K. Ritchie, and R. Merkel. 1995. Sensitive force technique to probe molecular adhesion and structural linkages at biological interfaces. *Biophys. J.* 68:2580–2587.
- Foxall, C., W. S. R., D. Dowbenko, C. Fennie, L. A. Lasky, M. Kiso, A. Hasegawa, D. Asa, and B. K. Brandley. 1992. The three members of the selectin receptor family recognize a common carbohydrate epitope, the sialyl Lewis<sup>x</sup> oligosaccharide. *J. Cell Biol.* 117:895–902.
- Fukuda, M. 1996. Possible roles of tumor-associated carbohydrate antigens. *Cancer Res.* 56:2237–2244.
- Fukuda, M., and Hindsgaul, O. 1994. Molecular glycobiology. In *Frontiers in Molecular Biology*. B. D. Hames and D. M. Glover, editors. Oxford University Press, New York. 261.
- Fukushima, K., M. Hirota, P. I. Terasaki, A. Wakasaka, H. Togashi, D. Dia, N. Suyama, Y. Fukushi, E. Nudelman, and S.-I. Hakamori. 1984. Characterization of sialosylated Lewis X as a new tumor-associated antigen. *Cancer Res.* 44:5279–5285.
- Goetz, D. J., B. K. Brandley, and D. A. Hammer. 1996a. An E-selectin-IgG chimera supports sialylated moiety dependent adhesion of colon carcinoma cells under fluid flow. *Ann. Biomed. Eng.* 24:87–98.
- Goetz, D. J., H. Ding, W. J. Atkinson, G. Vachino, R. T. Camphausen, D. A. Cumming, and F. W. Luscinskas. 1996b. A human colon carcinoma cell line exhibits adhesive interactions with P-selectin under fluid flow via a PSGL-1 independent mechanism. *Am. J. Pathol.* 149:1661–1673.
- Goetz, D. J., D. M. Greif, H. Ding, R. T. Camphausen, S. Howes, K. M. Comess, K. R. Snapp, G. S. Kansas, and F. W. Luscinskas. 1997. Isolated P-selectin glycoprotein ligand-1 dynamic adhesion to P- and E-selectin. *J. Cell Biol.* 137:509–519.
- Hakamori, S. 1989. Aberrant glycosylation in tumors and tumor-associated carbohydrate antigens. *Adv. Cancer Res.* 52:257–331.
- Hakamori, S. 1996. Tumor malignancy defined by aberrant glycosylation and sphingo(glyco)lipid metabolism. *Cancer Res.* 56:5309–5318.
- Hammer, D. A., and S. A. Apte. 1992. Simulation of cell rolling and adhesion on surfaces in shear flow: general results and analysis of selectin-mediated neutrophil adhesion. *Biophys. J.* 63:35–57.
- Hammer, D. A., and D. A. Lauffenburger. 1987. A dynamical model for receptor-mediated cell adhesion to surfaces. *Biophys. J.* 52:475–487.
- Handa, K., E. D. Nudelman, M. R. Stroud, T. Shiozawa, and S.-I. Hakamori. 1991. Selectin GMP-140 (CD62; PADGEM) binds to sialosyl-Le(a) and sialosyl-Le(x), and sulfated glycans modulate this binding. *Biochem. Biophys. Res. Commun.* 181:1223–1230.
- Hwang, W. C., and R. E. Waugh. 1997. Energy of dissociation of lipid bilayer from the membrane skeleton of red blood cells. *Biophys. J.* 72:2669–2678.
- Jacob, G. S., C. Kirmaier, S. Z. Abbas, S. C. Howard, C. N. Steininger, J. K. Welply, and P. Scudder. 1995. Binding of sialyl Lewis X to E-selectin as measured by fluorescence polarization. *Biochemistry.* 34:1210–1217.
- Karpatkin, S., and E. Pearlstein. 1981. Role of platelets in tumor cell metastases. *Ann. Intern. Med.* 95:636–641.
- Kim, Y. J., L. Borsig, H. L. Han, N. M. Varki, and A. Varki. 1999. Distinct selectin ligands on colon carcinoma mucins can mediate pathological interactions among platelets, leukocytes, and endothelium. *Am. J. Pathol.* 155:461–472.
- Kim, Y. J., L. Borsig, N. M. Varki, and A. Varki. 1998. P-selectin deficiency attenuates tumor growth and metastasis. *Proc. Natl. Acad. Sci. USA.* 95:9325–9330.
- Krause, T., and G. A. Turner. 1999. Are selectins involved in metastasis? *Clin. Exp. Metastasis.* 17:183–192.
- Kumar, R., R. T. Camphausen, F. X. Sullivan, and D. A. Cumming. 1996. Core2 B-1,6-N-acetylglucosaminyltransferase enzyme activity is critical for P-selectin glycoprotein ligand-1 binding to P-selectin. *Blood.* 88:3872–3879.
- Laszik, Z., P. J. Jansen, R. D. Cummings, T. F. Tedder, R. P. McEver, and K. L. Moore. 1996. P-selectin glycoprotein ligand-1 is broadly expressed in cells of myeloid, lymphoid, and dendritic lineage and in some non-hematopoietic cells. *Blood.* 88:3010–3021.
- Lawrence, M. B., and T. A. Springer. 1991. Leukocytes roll on a selectin at physiologic flow rates: distinction from and prerequisite for adhesion through integrins. *Cell.* 65:859–873.
- Leppanen, A., P. Mehta, Y. B. Ouyang, T. Ju, J. Helin, K. L. Moore, I. van Die, W. M. Canfield, R. P. McEver, and R. D. Cummings. 1999. A novel glycosulfopeptide binds to P-selectin and inhibits leukocyte adhesion to P-selectin. *J. Biol. Chem.* 274:24838–24848.
- Li, F., P. P. Wilkins, S. Crawley, J. Weinstein, R. D. Cummings, and R. P. McEver. 1996. Post-translational modifications of recombinant P-selectin glycoprotein ligand-1 required for binding to P- and E-selectin. *J. Biol. Chem.* 271:3255–3264.
- Liu, W. J., V. Ramachandran, J. Kang, T. K. Kishimoto, R. D. Cummings, and R. P. McEver. 1998. Identification of N-terminal residues on P-selectin glycoprotein-1 required for binding to P-selectin. *J. Biol. Chem.* 273:7078–7087.
- Magnani, J. L., B. Milsson, M. Brockhaus, D. Zopf, Z. Steplewski, H. Koprowski, and V. Ginsburg. 1982. A monoclonal antibody-defined antigen associated with gastrointestinal cancer is a ganglioside containing sialylated lacto-N-fucopentaose II. *J. Biol. Chem.* 257:14365–14369.
- McEver, R. P., and R. D. Cummings. 1997. Role of PSLG-1 binding to selectins in leukocyte recruitment. *J. Clin. Invest.* 100:485–492.
- Moore, K. L., K. D. Patel, R. E. Bruehl, F. Li, D. A. Johnson, H. S. Lichenstein, R. D. Cummings, D. F. Bainton, and R. P. McEver. 1995. P-selectin glycoprotein ligand-1 mediates rolling of human neutrophils on P-selectin. *J. Cell Biol.* 128:661–671.
- Patel, K. D., and R. P. McEver. 1997. Comparison of tethering and rolling of eosinophils and neutrophils through selectins and P-selectin glycoprotein ligand-1. *J. Immunol.* 159:4555–4565.
- Polley, M. J., M. L. Phillips, E. Wayner, E. Nudelman, A. K. Singhal, S. I. Hakamori, and J. C. Paulson. 1991. CD62 and endothelial cell-leukocyte



- adhesion molecule 1 (ELAM-1) recognize the same carbohydrate ligand, sialyl-Lewis X. *Proc. Natl. Acad. Sci. USA.* 88:6224–6228.
- Poppe, L., G. S. Brown, J. S. Philo, P. V. Nikrad, and B. H. Shah. 1997. Conformation of sLex tetrasaccharide, free in solution and bound to E-, P-, and L-selectin. *J. Am. Chem. Soc.* 119:1727–1736.
- Pottratz, S. T., T. D. Hall, W. M. Scibner, H. N. Jayaram, and V. Natarajan. 1996. P-selectin-mediated attachment of small cell lung carcinoma to endothelial cells. *Lung Cell. Mol. Physiol.* 15:L918–L923.
- Pouyani, T., and B. Seed. 1995. PSGL-1 recognition of P-selectin is controlled by a tyrosine sulfation consensus at the PSGL-1 amino terminus. *Cell.* 83:333–343.
- Sako, D., K. M. Comess, K. M. Barone, R. T. Camphausen, D. A. Cumming, and G. D. Shaw. 1995. A sulfated peptide segment at the amino terminus of PSGL-1 is critical for P-selectin binding. *Cell.* 83:323–331.
- Smith, M. J., E. L. Berg, and M. B. Lawrence. 1999. A direct comparison of selectin-mediated transient, adhesive events using high temporal resolution. *Biophys. J.* 77:3371–3383.
- Springer, T. A. 1994. Traffic signals for lymphocyte recirculation and leukocyte emigration: the multistep paradigm. *Cell.* 76:301–314.
- Stone, J. P., and D. D. Wagner. 1993. P-selectin mediates adhesion of platelets to neuroblastoma and small cell lung cancer. *J. Clin. Invest.* 92:804–813.
- Swift, D. G., R. G. Posner, and D. A. Hammer. 1998. Kinetics of adhesion of IgE-sensitized rat basophilic leukemia cells to surface-immobilized antigen in couette flow. *Biophys. J.* 75:2597–2611.
- Takada, A., K. Ohmori, N. Takahashi, T. Kiyotaka, Y. A., K. Zenita, A. Hasegawa, and R. Kannagi. 1991. Adhesion of human cancer cells to vascular endothelium mediated by a carbohydrate antigen, sialyl Lewis A. *Biochem. Biophys. Res. Commun.* 179:713–719.
- Tees, D. F., O. Coenen, and H. L. Goldsmith. 1993. Interaction forces between red cells agglutinated by antibody IV: time and force dependence of break-up. *Biophys. J.* 65:1318–1334.
- Usami, S., H. H. Chen, Y. Zhao, S. Chien, and R. Skalak. 1993. Design and construction of a linear shear stress flow chamber. *Ann. Biomed. Eng.* 21:77–83.
- Wilkins, P. P., K. L. Moore, R. P. McEver, and R. D. Cummings. 1995. Tyrosine sulfation of P-selectin glycoprotein ligand-1 is required for high affinity binding to P-selectin. *J. Biol. Chem.* 270:22677–22680.