

ONSET OF CONTRACTILITY IN CARDIAC MUSCLE

By ALLAN J. BRADY

*From the Los Angeles County Heart Association Research Laboratory
UCLA Medical Center, Los Angeles,
California, U.S.A.*

(Received 28 May 1965)

SUMMARY

1. A technique is described whereby (i) quick stretches and releases of controlled velocity, amplitude and time of onset can be applied to muscle. (ii) Releases from isometric to isotonic contraction can be performed at controlled delays relative to the stimulus, and displayed on a delayed expanded oscilloscope sweep. An isotonic lever system with an equivalent mass of 12.8 mg is described.

2. Quick stretch of rabbit or cat papillary muscle after excitation does not result in a level of tension equal to or greater than normal peak isometric tension appropriate to the stretched length. Stretches applied during the first half of the rising phase of tension development give responses nearly identical to the same stretches applied before the stimulus (indicating that Starling's Law of the heart holds until this time). Stretches applied in the later phase of tension development or during relaxation result in diminished peak isometric tensions or accelerated relaxation.

3. The rate of tension development following quick releases of isometrically contracting muscle to zero tension is not maximal until the releases are made 150–200 msec after excitation.

4. Shortening velocity with light afterloads is not initially maximal nor constant for an appreciable period of time. The shortening velocity with heavy afterloads reaches its maximum more rapidly when the load is not lifted within the first 200 msec of a contraction which, if maintained isometric, would have required 400–500 msec to reach peak tension. With these heavier loads, a period of 100–200 msec of constant shortening velocity may occur.

5. Freeloaded isotonic contractions show an inflexion in their shortening curves occurring 150–200 msec after excitation.

6. Maximum rate of isotonic shortening following releases from isometric to isotonic contraction with a given load is not maximal until the releases occur about 200 msec after the stimulus.

7. It is concluded that contractility in cardiac muscle is relatively slow in its onset with maximum capacity to shorten occurring about midway through the rising phase of isometric tension development.

INTRODUCTION

The similarities between the mechanical properties of skeletal and cardiac muscle invite a study of cardiac muscle in terms of the three element analogue of Hill (1938): a contractile element whose shortening velocity is uniquely determined by the force on it, an undamped series elastic element and a parallel elastic element which supports the resting tension. However, cardiac muscle exhibits features which complicate its mechanical analysis in terms of the classical techniques applied to skeletal muscle: (i) appreciable resting tension is present in heart muscle at all lengths at which active tension is developed; thus, muscle tension measured at the ends of the preparation is always a combined tension; (ii) peak isometric tension is strongly dependent upon muscle length so that even small changes in length, such as in quick releases or at the onset of shortening in afterloaded contractions, must alter the contractile force (total tension minus resting tension); (iii) cardiac muscle cannot be tetanized; thus the value of the maximum contractile tension at a given muscle length, P_0 , is in doubt. Consequently, the investigation of the cardiac contraction with procedures independent of time is precluded. The presence of the resting tension would be of no great consequence if the ability of the muscle to lift a load were initially maximal. A simple correction could be made to the total load. However, a delay in the attainment of the maximum shortening velocity, as will be described here, would introduce an unknown increase in the load seen by the contractile element as the resting tension fell with muscle shortening. A further complication was revealed by the quick stretch experiments of Abbott & Mommaerts (1959) in which their rapid stretches temporarily abolished the ability of the muscle to develop active tension, thus preventing a determination of either P_0 , or of the time course of the rise of the contractile force.

The object of the present study was to establish the time dependence of the onset of contractility in mammalian papillary muscle by (i) using the quick stretch technique, but controlling the stretch velocity (Brady, 1964), (ii) releasing the muscle to zero tension and noting the rate of redevelopment of tension, (iii) correlating these data with the shortening velocity in afterloaded and freeloading contractions, and (iv) measuring the shortening velocity following a release to a given load at various times after excitation (Jewell & Wilkie, 1960). A summary of these findings has been given in a preliminary report (Brady, 1965).

Because of the peculiar nature of both elastic and active contractile

properties of heart muscle, the techniques used to define the active state of skeletal muscle have not given rise to a similar operational definition for cardiac contraction, neither the time course nor the intensity of the basic contractile force of the heart being known. Thus, the term 'contractility' will here be used instead to express the ability of the muscle either to manifest a tension or to lift a load. Blinks & Koch-Weser (1963), who also use this term, stipulated that a change in tension due to a change in muscle length does not constitute a change in myocardial contractility. This stipulation will be accepted here only as regards changes in length during the first half of the rising phase of the contraction. Evidence will be given in a subsequent paper that any displacement of the muscle in the last half of the rising phase of contraction or during relaxation leads to a decline in contractility.

METHODS

Papillary muscles from the right ventricles of rabbits and cats were used in these experiments. The animals were anaesthetized with ether or Phenobarbital (0.5 ml./kg) and, on some occasions, curare (0.1 ml./kg) was also administered. Some rabbits were stunned by a blow on the head, but the mode of induction of anaesthesia had no observable effects on the experimental results. The entire heart was then excised and placed in a vessel of oxygenated perfusate at room temperature. An opening was quickly cut through the right ventricular wall and a small polyethylene oxygen line inserted into the right ventricle. The tissue was thus oxygenated continuously during the removal of the right ventricular wall and excision of the selected papillary muscle. Suitable muscles ranged in weight from 0.3 to 5.0 mg and in length from 3 to 10 mm. None exceeded 1.0 mm diameter.

It was found that recovery of contractile tension after excision was almost immediate if the papillary muscle was tied to a light spring bow before cutting its tendon and base. This procedure maintained continuous tension in the muscle during its transfer from the dissection dish to the recording chamber and mounting to the gauges. Frequently, if spontaneous contractions occurred in the unrestrained muscle, considerably longer recovery periods were necessary.

The muscle and the chamber were oriented horizontally to enable impalement of the tissue with micro-electrodes (Fig. 1), but the electrical studies are not reported here. Perfusate from an oxygenated reservoir entered the chamber continuously at one end through a spiral line overlaying the surface of a Westinghouse (WX 814) thermo-electric temperature-regulating device. Temperature was maintained at 22° C. The perfusate left the muscle chamber with minimum agitation of the surface by overflowing through a wick into an adjacent chamber from which it was aspirated. Temperature was monitored with a thermistor in the chamber near the muscle. Electrolyte concentrations in the perfusate were (mM): NaCl, 130; KCl, 4.0; CaCl₂, 5.0; MgCl₂, 5.0; MgCl₂, 1.0; NaHCO₃, 10.0; NaH₂PO₄, 0.43. Glucose (1 g/l.) was also added. A 98% O₂-2% CO₂ gas mixture was bubbled through the solution giving a pH of 7.2-7.4.

Platinum stimulating electrodes, wider and longer than the muscle, were mounted in the chamber on either side of the muscle and within 0.5 mm of the tissue. The stimulus current was delivered by a constant current generator capable of 500 mA output, the waveforms being generated by combined Tektronix 161-162 units. Normal stimuli were rectangular pulses 1-3 msec in duration and 100 mA in intensity.

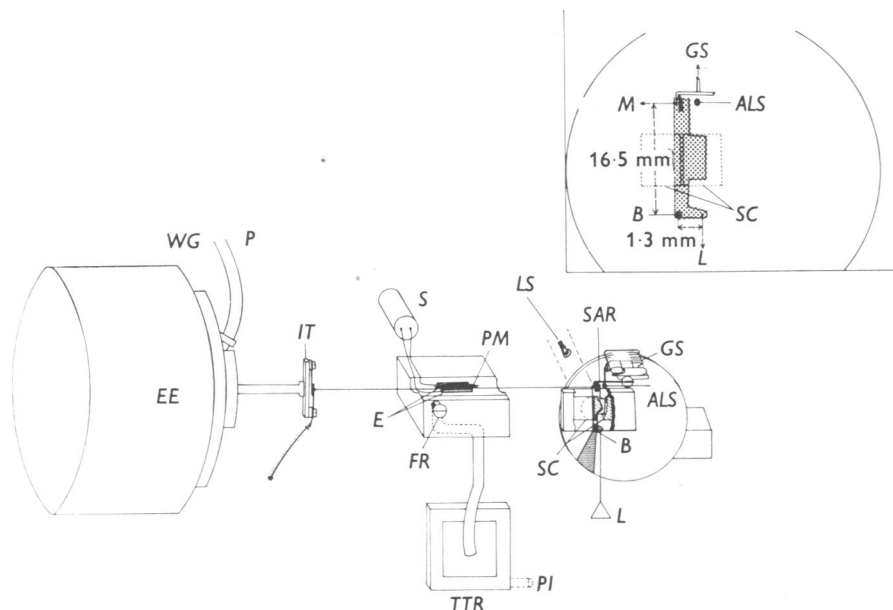

Fig. 1. Arrangement of muscle chamber, ergometer, and isometric and isotonic transducers used in quick stretch and release experiments, providing simultaneous length and tension measurements. Details of the isotonic lever support and release are shown in the inset. *EE*, electromagnetic ergometer; *WG*, wave-form generator; *P*, position indicator; *IT*, isometric transducer; *S*, stimulator; *E*, stimulating electrodes; *PM*, papillary muscle; *FR*, flow regulator for the perfusate; *TTR*, thermoelectric temperature regulator; *PI*, perfusate input; *SC*, solar cells; *B*, bushing at lever fulcrum; *L*, load; *LS*, light source; *ALS*, afterload stop; *GS*, gated solenoid; *SAR*, solenoid actuated release; *M*, wire attachment to muscle.

Tension measurements

When it was convenient to have a length transducer at one end of the muscle and a tension transducer at the other, an acceleration-compensated capacitance force transducer was mounted on the end of the ergometer as in Fig. 1. The fixed and variable plates of this transducer were balanced so that the accelerometer effects due to rapid displacements by the ergometer were negligible. The response of this transducer was linear in the range 0–5 g wt. tension. Its compliance was such that a force of 5 g wt. displaced the movable plate 4μ . The noise level, peak to peak, was equivalent to 15 dyn. One end of the muscle was tied to a hook at the end of a stainless-steel wire (diameter 0.5 mm), which was attached to the tension transducer. The other end of the muscle was tied to a lighter wire (diameter 0.175 mm) which connected it to the length transducer. The lever of the length transducer was held between a pair of stops. In all experiments the tendon end of the muscle was tied at the junction of the muscle tissue and tendon. The other tie was so placed as to obtain as long a preparation as possible but still on a uniform diameter of the muscle. All ties were made with 13/15 denier monofilament silk thread (diameter 30μ). Each tie required 2–3 mm of thread, including knots.

In most of the quick-stretch experiments, a rigid coupling was substituted for the usual tension transducer, and tensions were recorded by means of a capacitance transducer (Schilling, 1960), which was mounted in place of the length recording system in Fig. 1. This

force transducer could be used to measure tensions up to 15 g wt. Its compliance was 0.25 μ /g wt., and its noise level was equivalent to 5 dyn peak to peak.

Length measurements

The isotonic transducer, designed and constructed by M. O. Schilling, was made from a watch movement in which the lever replaced the balance wheel but utilized its shaft and jewelled bushings. Displacement of the lever was detected photo-electrically using a pair of solar-cells (Hoffman Electronics, Evanston, Ill.). Since the muscle was mounted horizontally, the lever was connected to the load and muscle in a bell-crank arrangement (Fig. 1, inset). The equivalent mass of the lever at the point of attachment of the muscle was 4.8 mg, calculated from the dimensions of the lever and its natural period when suspended from the fulcrum. The equivalent mass of the moving system was increased by 6.2 mg, due to the presence of the wire connecting the muscle to the long arm of the lever and another wire which was used to attach the load to the short arm of the lever. A fine spiral hair spring, concentric with the pivot shaft, was used to balance the lever in the top dead-centre position.

Because of the horizontal arrangement of the tissue, a Teflon support was placed under the wire connecting the muscle to the isotonic transducer. The wire at the other end of the muscle was rigidly mounted to the isometric transducer on the ergometer and needed no further support. Drag in the system due to friction on the Teflon surface and in the bushings of the isotonic transducer was 10 dyn at a velocity of 1.3 mm/sec. Stray compliance of the entire system including ties (measured with a stainless-steel wire tied in place of the muscle) was 20 μ /g wt. More than half of this compliance was attributed to a slight sagging of the hooks due to the horizontal orientation of the system. This compliance was not deemed serious, since it only amounted to about 0.7% of a muscle length at the typical twitch tension. Noise equivalent of the isotonic transducer was 1 μ , peak to peak.

Release from isometric to isotonic contraction

For the release experiments, the isotonic gauge contained a solenoid-operated stop against which the muscle contracted isometrically until the stop was withdrawn. In the release experiments, oscillations of the moving system were minimized by loading the lever with one of two long linear springs which was damped by immersion in a glycerol-water-bath. For large loads, a heavy spring was used. At the point of attachment of the muscle, its equivalent mass was 93 mg and its effective stiffness was 56.2 mg wt./mm of muscle shortening. For smaller loads (50–300 mg wt.) a lighter spring was used. Its equivalent mass was 2.1 mg and its effective stiffness was 21.2 mg wt./mm of muscle shortening. With these values for the effective stiffness, the variation of the load on the muscle during shortening was a negligible fraction of the total load in both cases. The operational equivalent mass of the entire system (lever + connecting wires + load and balance springs + muscle and fluid displaced) was estimated to be 106 mg with the larger spring and 15 mg with the smaller spring. Loads for afterloaded isotonic contractions were selected by adjusting the length of the load spring. On some occasions, weights were used for loads, but the inertial correction for these is considerably larger than for the springs.

Velocity measurements

In some cases the shortening velocity was measured graphically from the shortening records, but more accurate results were obtained by electrical differentiation of the output of the length transducer. A Philbrick P65A operational amplifier, connected as a differentiator with an empirical time constant of 2 msec, was used for this purpose. Its output was passed through a low-pass filter which had a slope of -12 db/octave starting at 80 c/s. In the case of the released contractions, the velocity during shortening of the undamped elasticity far exceeded that of the muscle immediately following the step. True shortening velocities following the step could not be measured therefore until 10–20 msec after the

step, due to the time constant of the differentiator and its filter. Noise level of the differentiator was equivalent to a velocity of $60 \mu/\text{sec}$. Length and velocity following the release were usually displayed on the oscilloscope with a delayed expanded sweep.

Ergometer

In order to impose length changes on the muscle, an ergometer was constructed from a modified speaker magnet and voice coil (Jim Lansing Model 375, Los Angeles Calif.). Details of its construction and operation will appear elsewhere, but the principle is similar to that described by Machin & Pringle (1959). The voice coil was attached to the muscle through a thin aluminium cone and a stainless-steel shaft. The end of the shaft was fitted either with a stainless-steel wire terminating in a hook for attachment directly to the muscle or to a mount for the acceleration compensated isometric tension transducer.

The ergometer was driven with a d.c. power amplifier with position feed-back from the voice coil shaft. The over-all frequency response of the system was flat, 0–60 c/s and 3 db down at 70 c/s. The wave-form generator and power amplifier driving the ergometer were capable of producing positive or negative going ramps with slopes up to 150 mm/sec, the ramps terminating in a plateau of arbitrary height and duration. Onset of the ramps could be accurately timed with respect to the muscle stimulus. Equivalent noise level of the ergometer was 5μ .

Recording

Data were recorded on a Sanborn (320) two-channel chart recorder and a Tektronix 555 Dual Trace Oscilloscope. Split beam vertical amplifiers were used on both oscilloscope channels allowing display of four signals. For the release experiments shortening and shortening velocity were displayed on the delayed expanded sweep at sweep speeds sufficient to measure the shortening velocity 10–20 msec after the release. A Beattie-Coleman 35 mm camera was used to photograph the traces appearing on a slave tube of the oscilloscope. Data were read directly from the Sanborn chart record and from the film with a projector at $10 \times$ magnification.

Setting-up procedure

Since a length of cardiac muscle equivalent to L_0 in skeletal muscle (body length or a length at which resting tension becomes noticeable) is impractical as a standard, an initial length was generally chosen for the isometric experiments which gave near maximal active tension. Active tension development in this range is only moderately dependent upon length ($\pm 5\%$ length change in the vicinity of the length at which maximum active tension is developed reduces active tension development by 10%), but the resting tension increases rapidly over this range so that the decline in active tension at greater lengths becomes less obvious.

The effects of rapid length changes were reversible after a few seconds equilibration time unless the stretches were so great that obvious damage occurred to the fibres. Thus, when large stretches were given which would carry the contractile tension response much beyond its maximum, shorter initial lengths were used. In the isotonic experiments, numerous preloads were used, depending on the experiment; but, immediately after mounting, a load of 280 mg wt. was usually attached during the 30 min equilibration period. Stimuli at 5 sec intervals were maintained throughout this period in all cases.

During the initial 10–15 min of the equilibration period, isotonic shortening with a given load or isometric tension tended to increase and then generally remained stable for several hours. Frequently, after an increase in resting length, both isometric tension and isotonic shortening declined slowly over a period of about 5 min, but this was directly correlated with a fall in resting tension or preload. Similarly, following a decrease in resting length, isometric tension or isotonic shortening slowly increased. However, an isometric transducer was always attached to one end of the muscle so that a correction of the tension could be made for the drift, either numerically or by a length adjustment.

The ratio Pl/m (P , isometric tension; l , resting length; m , blotted wet weight) in our muscles range from 400 to 600 g wt./cm². Abbott & Mommaerts (1959) reported a value of 200 g wt./cm² and Sonnenblick (1964) gave a value of 600 g wt./cm² for the same preparation. The criterion for the rejection of a muscle was simply a failure to maintain or to recover a tension of this magnitude (400–600 g wt./cm²) during the equilibration period.

RESULTS

Quick stretch

Abbott & Mommaerts (1959) used the quick stretch technique (Hill, 1949) in order to determine whether cat papillary muscles are capable of bearing a high tension soon after excitation. These stretches, however, were quite fast (about 1 m/sec) and appeared to interrupt the development of contractile tension. Figure 2*A* shows the results of an experiment in which stretches of fixed amplitude, but variable velocity, were applied to the muscle in such a way that they all ended in a plateau 50 msec after the stimulus. The tension records show a variable amount of stress relaxation following the stretch, but the subsequent tension changes were independent of the stretch velocity; they were also indistinguishable from the tension changes that followed the application of a rapid stretch at the same time as the stimulus. Stretches ending 100 or 150 msec after the stimulus (not shown) gave similar results, but stretches terminating in a later phase of the tension development (Fig. 2*B*) or during relaxation tended to reduce the subsequent ability of the muscle to manifest tension.

Since the velocity of stretch early after excitation is not critical (cf. Hill, 1949) a stretch velocity of 75 mm/sec was used in most cases. The superimposed records of Fig. 3 show some of the responses to a given amount of stretch, applied at various times during contraction. A slippage occurs following later stretches such that the course of subsequent tension development falls below that for the same stretch applied earlier. Increasing the amplitude of the stretch may increase the resting tension manyfold and markedly enhance the slippage. These effects are shown in Fig. 4 in which the stretch began at different initial muscle lengths, but the final length was the same in all cases.

No plateau of tension development appears until stretches are given 200 msec or more after the stimulus. Stretches applied after this time may result in a plateau after stress relaxation but the level of the plateau is less than isometric tension at the stretched length. The tension increase which follows the stress relaxation with earlier stretches is less with very large stretches, but a stretched length is never reached at which tension falls continuously after the stretch, unless the stretch is given in the later half of the rising phase of normal tension development. Abbot & Mommaerts (1959) and Sonnenblick (1964) have reported a series compliance

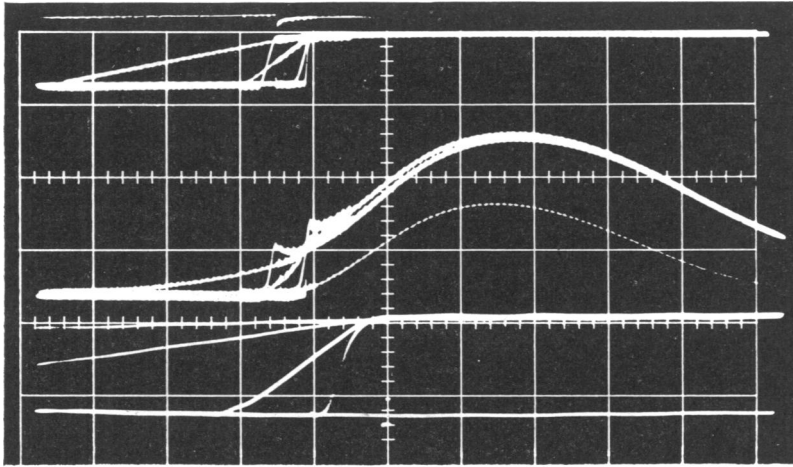

A

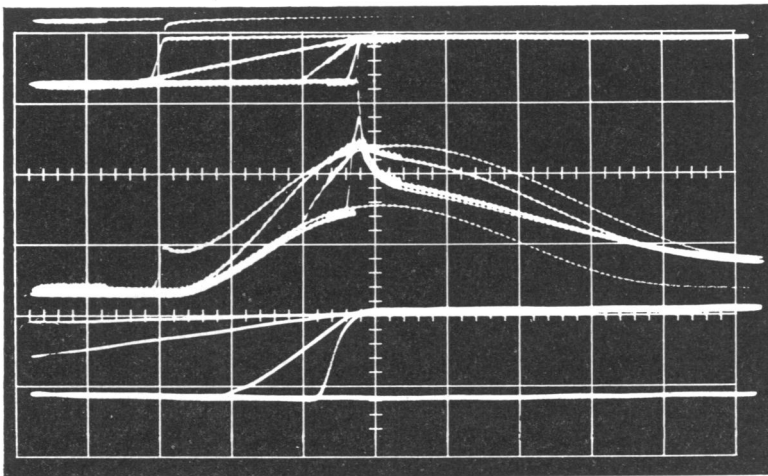

B

Fig. 2. Tension responses of papillary muscle to stretches of equal amplitude (0.35 mm) but different velocities. *A*. Stretches of velocities 1.13, 3.5, 17.5, 75 mm/sec beginning at the same initial muscle length and terminating 50 msec after the stimulus. One response to a stretch of 75 mm/sec and terminating at the time of the stimulus is given for comparison. Upper traces: stimulus (top), length changes, 0.42 mm/major division; centre traces: tension responses (lowest amplitude tension record is normal unstretched isometric tension), 0.53 g wt./major division; lower traces: length changes on delayed expanded sweep, 0.21 mm/major division. Normal time base, 100 msec/major division. Expanded sweep time base, 10 msec/major division. *B*. Same as *A*, except stretches terminate 275 msec after the stimulus. Initial muscle length, 4.18 mm. Muscle wt. 0.82 mg. Temperature in this and all other experiments was 22° C.

of the order of 5–10% of the initial muscle length for forces equal to peak isometric tension in the heart. Thus, these stretches should be adequate to reveal an early ability of the muscle to develop tension.

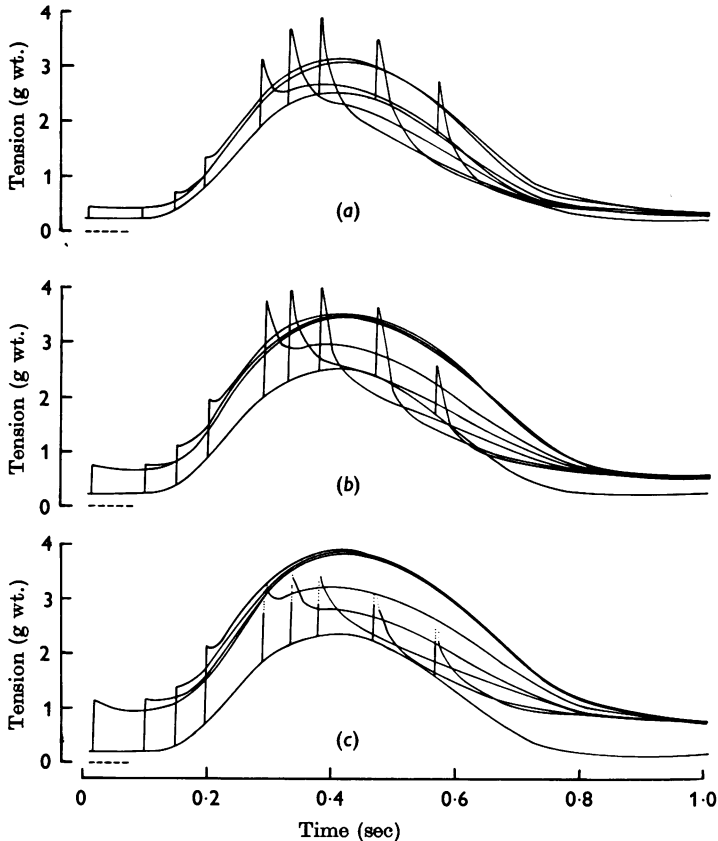

Fig. 3. Tracings of tension responses to quick stretch. (a) Stretch, 2% of initial length, (b) 5%, (c) 7%. Stretches relative to the stimulus occurred at 0.09, 0, 0.05, 0.10, 0.20, 0.25, 0.30, 0.40, 0.50 sec. Peak tensions in the lower series were too high and faint to be recorded and are partially indicated by dotted lines. Muscle wt. 0.82 mg. Initial length, 5.5 mm.

It is particularly interesting to note that a given stretch applied 200 msec before or 100–200 msec after the stimulus gives rise eventually to about the same peak isometric tension corresponding to the new length. The implication of this observation relative to Starling's Law of the Heart will be discussed later.

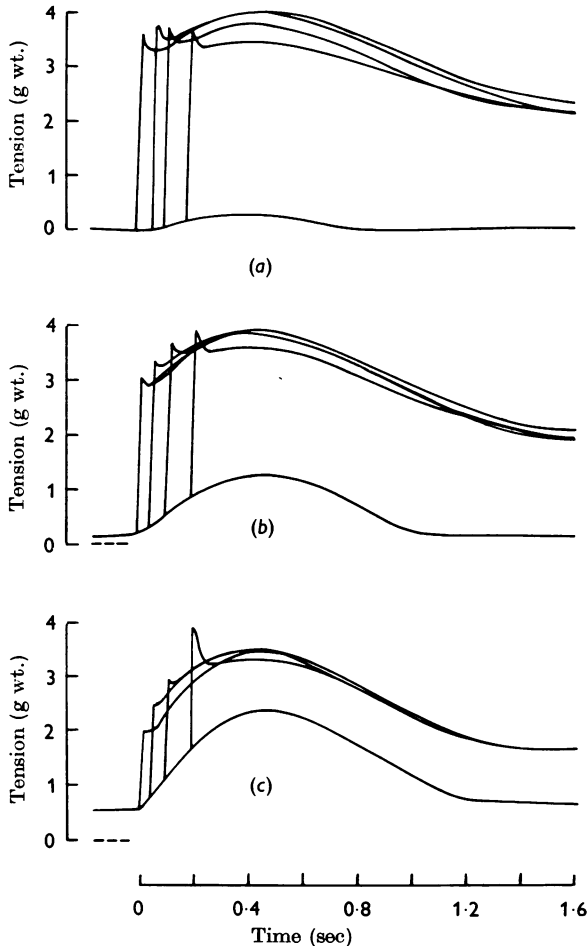

Fig. 4. Tracings of quick stretch responses beginning at different initial muscle lengths and stretching to the same final length. (a) Initial length, 4.70 mm; (b) 5.5 mm; (c) 6.03 mm. Final length in each case, 6.30 mm. Stretches, relative to the stimulus, were given at 0, 0.05, 0.10, 0.20 sec. Muscle wt. 3 mg.

Redeveloped tension following quick release

In Fig. 5, the redeveloped tension following a quick release to zero tension is illustrated for releases at increasing times after stimulation. In the lower traces the tension redevelopment after the release is superimposed at the time of release and displayed on an expanded sweep. Maximum rate of rise of redeveloped tension does not appear until the release occurs about 150 msec after the stimulus. Considerable variability can occur in these data because the rate of reformed tension following the

release is extremely dependent upon the extent of the release. Under-shooting or overshooting the length at which zero tension transiently appears can lead to large changes in the maximum rate of tension redevelopment. Since the amount of release required to drop the tension just to zero depends on the tension at the time of release (which is a function of time after the stimulus), this method is not very satisfactory for quantitative studies of the onset of contractility.

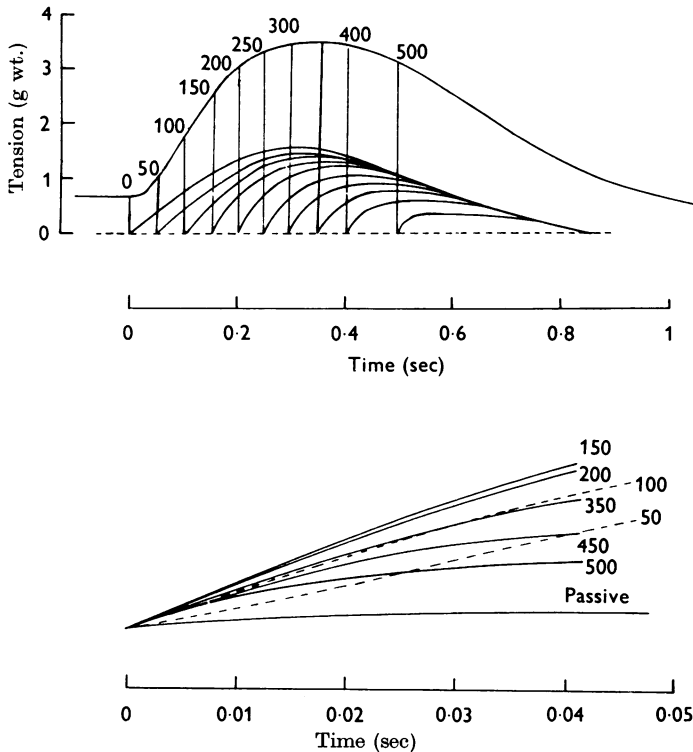

Fig. 5. Tracings of tension responses to quick release to zero tension. Upper traces, tension responses. Lower traces, redeveloped tension superimposed about the time of release and displayed on a delayed expanded sweep. Numbers to the right indicate time of release after the stimulus in msec. Passive response is that of a release without stimulation.

Isotonic shortening

Afterloaded contractions. If the failure of the muscle to bear a load early after excitation were due to a slow onset of contractility, then the shortening records might be expected to show an inflexion, corresponding with acceleration of the muscle, when a light load is lifted early in the contraction. The shortening traces for the light load shown in Fig. 6 do have a noticeable inflexion with loads lifted before 200 msec. The velocity with

which light loads are lifted increases during the first 200 msec and then begins to fall after only a short period of relatively constant shortening velocity. The shortening velocity with heavier loads lifted later in the contraction appears to be more abrupt in its onset and may be relatively constant for as long as 100–200 msec.

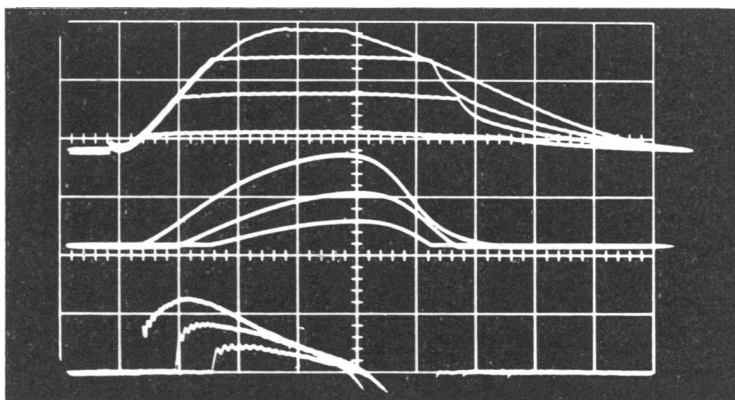

Fig. 6. Isometric tension, shortening and shortening velocity in afterloaded contractions. Upper beam, tension, 1.43 g wt./major division; centre beam, length, 0.42 mm/major division; lower beam, velocity, 1.75 mm/sec/major division. Loads, 0.15, 0.5, 1.0, 1.5 g wt. Velocities during relaxation are not shown. Initial muscle length, 6.63 mm; wt. 2.0 mg.

Freeloaded contraction. Shortening velocity would be expected to be more dramatically time dependent in free-loaded contractions, because shortening begins earlier and a decrease in contractile force due to shortening may be more evident. However, maximum shortening velocity again occurs around 200 msec (Fig. 7) except for very light loads where the length is short. Under the latter conditions, the maximum shortening velocity may occur somewhat earlier, but its absolute value is lower than for larger loads.

Release from isometric to isotonic contraction

The results described so far indicate that cardiac muscle, unlike skeletal muscle, cannot bear a load or shorten with maximum velocity immediately after excitation. However, if the onset of contractility is time dependent, its time course will be complicated in either afterloaded or preloaded shortening velocity measurements, because in the afterloaded case heavier loads are lifted later in the cycle than light loads, and in freeloading conditions the initial muscle lengths are different. These complexities can be reduced by releasing a muscle from an isometric contraction to a given load at various times after the muscle can lift this load, and noting the shorten-

ing velocity after the undamped step change in length accompanying the release (Jewell & Wilkie, 1960).

In the range of lengths over which the slope of the active length-tension relation is positive, it would be expected that contractility would fall somewhat even during isometric contraction due to internal shortening. Releases at progressively later times then should reveal decreasing initial shortening velocities unless the time dependence of the shortening velocity is greater than its length dependence over the change in length incurred.

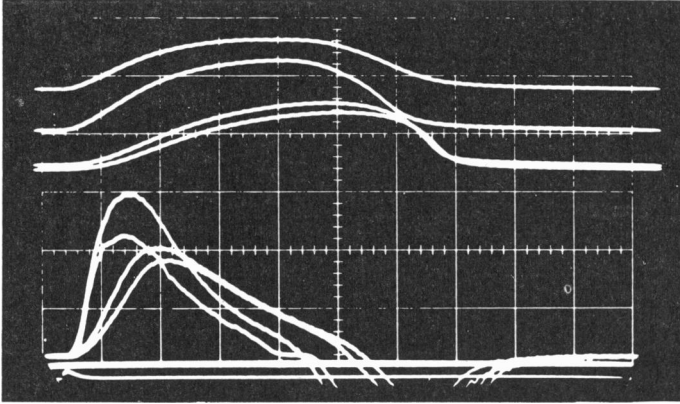

Fig. 7. Length and velocity of shortening in freeloaded contractions. Upper traces; length (1.05 mm/major division) with loads, from top to bottom, of 0.02, 0.1, 0.5, 0.7 g wt. Lower traces; velocity (1.75 mm/sec/major division). In maximum height, velocity records correspond to loads of 0.1, 0.02, 0.5, 0.7 g wt., respectively. Sweep speed, 100 msec/major division. Velocities during relaxation are not shown. Bottom trace indicates stimulus time. Muscle length, 6.48 mm at 0.1 g wt. load. Muscle wt. 2.0 mg.

Figure 8 shows tracings of simultaneously recorded responses of tension, shortening, and shortening velocity for releases to a load equal to about 20% of isometric tension. Length and velocity time bases near the time of release are expanded 10-fold for better resolution of these events, immediately following the step. Note that the shortening velocity which follows the initial step change of length is not maximal until releases are given at least as late as curve *d* and if the velocity could be measured accurately immediately after the step, the initial velocity in curves *e* or *f* might be greatest. The expanded length traces of *e* appear to have a higher initial slope than *d* but the lever oscillations tend to obscure these measurements for the first 10 msec after the release. It is readily apparent, however, that the initial shortening velocity of the afterloaded contraction (curve *a*) is not the maximum velocity with which the muscle could lift this load. It is also apparent that the shortening velocity following a release at peak isometric tension (curve *g*) is lower than for some earlier releases.

Note from the velocity traces in Fig. 8 that the initial shortening velocity of each release is maximal for releases given 150 msec or later after the stimulus (curves *c-g*) but is inaccurate for the first 5–10 msec after the release. With releases before this time, maximum shortening velocity occurs with some delay after the release (curves *a, b*). Thus, in order to

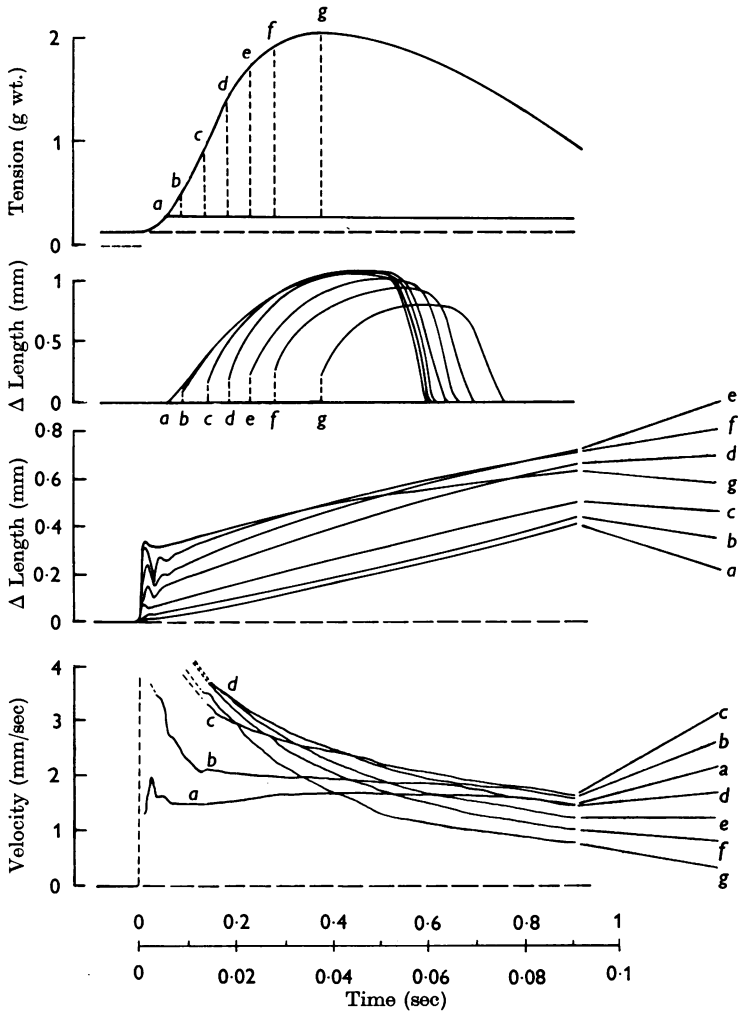

Fig. 8. Tension, length and shortening velocity responses to releases from isometric to isotonic contraction. Load, 280 mg. Letters indicate the correspondence of the tracings. The lower time scale applies to the lower set of length tracings and the velocity tracings. The two sets of length responses are the same except the lower group is displayed at higher gain and on a delayed expanded sweep and superimposed about the time of release. The vertical interrupted lines indicate oscilloscope traces too faint to be recorded.

establish a fixed time after the release at which the velocity of the release could be measured, the velocity in each case was measured 20 msec after the release and henceforth will be referred to as the post-release velocity (PRV).

In Fig. 9*A*, PRV is plotted as a function of the time of release for cat papillary muscle. Figure 9*B* shows similar relations for a rabbit papillary muscle released against different loads. The maximum PRV with all loads starts to decline before the tension reaches its peak in an isometric response. The time at which the decline begins may depend only slightly or not at all on the load except for the releases to loads less than 10% of isometric tension. With these light loads, the maximum PRV may occur for releases 50–100 msec after the stimulus; but the velocity with later releases to these light loads may be less than that for releases to heavier loads at the same delay.

The general form of the PRV-release time relations, however, is independent of the initial muscle length in all experiments reported here (lengths equal to or less than that at which maximum active tension was developed).

DISCUSSION

In general, the data reported here show that cardiac muscle responds to stretches and releases differently from frog or toad sartorius. It is also apparent that only a limited quantitative description of cardiac muscle contractility can be made with the experimental procedures used for skeletal muscle. The following discussion will evaluate these limitations and suggest some possible causes and consequences of the differences between the behaviour of skeletal and cardiac muscle.

Resting tension

One source of complication is the tension present in the passive parallel elastic elements of the resting muscle. Its dependence on length is readily seen in the experiments illustrated in Figs. 2–4, where large increases in resting tension accompany the larger stretches. In afterloaded and free-loaded contractions (Figs. 6, 7), the load supported by the contractile element must therefore increase as the load is lifted and the resting tension component is shifted in part or completely to the contractile element; consequently, the velocity of shortening should decline progressively. The acceleration seen in the shortening curves of Figs. 6 and 8 cannot, therefore, be due to the unloading of the parallel elastic element.

In the experiments with releases to isotonic contraction, the shortening velocity following the step change in length may still be influenced by the resting tension in the same way as are the afterloaded and free-loaded contractions, but to a lesser extent; the undamped shortening should

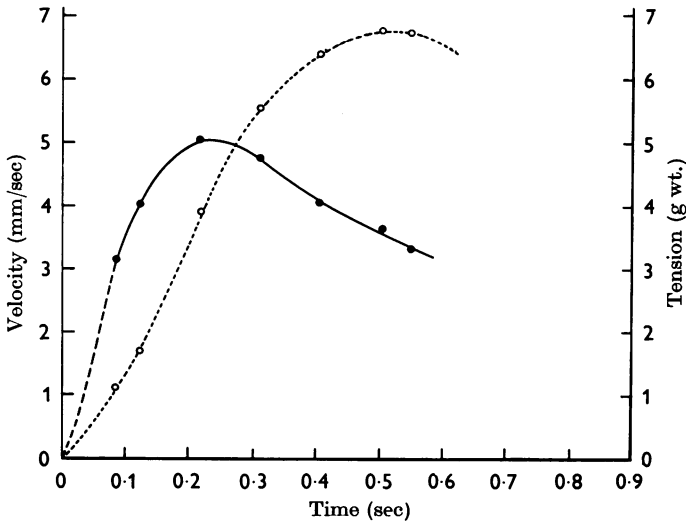

A

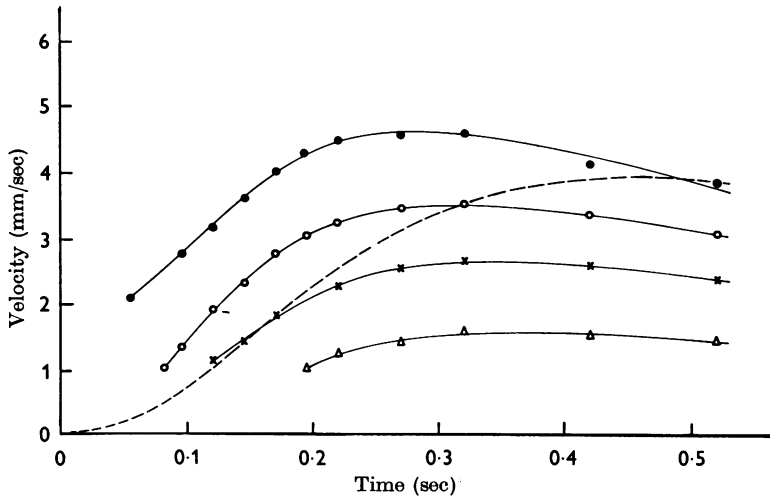

B

Fig. 9. Velocity of shortening after a release from isometric to isotonic contraction. *A*. Shortening velocity following the release of a cat papillary muscle to a 0.28 g load (continuous line) plotted as a function of the time of release; dotted line with open circles shows corresponding isometric contraction. Interrupted line on velocity curve indicates probable onset of shortening velocity capability. Muscle wt. 6.7 mg. *B*. Similar to *A*, but for releases of a rabbit papillary muscle to different loads. From top to bottom, loads were 0.28, 0.48, 0.78, 1.28 g wt., respectively. The first point in each curve is the afterloaded shortening velocity plotted at the time the velocity reached its maximum. Rise of isometric tension is indicated by the interrupted line. Muscle wt. 6.25 mg.

reduce the resting tension so that the load seen by the contractile element is more nearly constant rather than increasing. It is apparent that all shortening velocities reported here reflect changes in load on the contractile component due to changes in the resting tension; however, these changes, though significant, are relatively small and, in any case, do not account qualitatively for the absence of initially maximal shortening velocities as observed in skeletal muscle.

Evidence for slow onset of contractility

Quick stretch. Skeletal muscle displays a continuous increase in resistance to stretch after excitation, but a stretched length can be attained early after excitation at which a subsequent increase in contractile tension no longer occurs. The resistance of cardiac muscle to stretch also progressively increases after excitation as the undamped elastic elements are stretched by the contractile element; but it is evident from Figs. 2-4 that no matter how large, nor how rapid the stretch applied early during contraction, the papillary muscle will not bear a load greater than that it normally develops during an isometric twitch at the stretched muscle length.

Redeveloped tension. The experiments in which the rate of tension redevelopment was measured following a release to zero tension are the least reliable but are consistent with the other data. The long time required for the maximum rate of tension redevelopment to be manifest after the release (150 msec) is significant because progressively larger releases were required to reduce the tension to zero as the series elastic elements were stretched in the normal course of isometric tension development before the release. If the contractile force were initially maximal and then either remained constant or declined, the initial rate of redeveloped tension following the larger releases would be expected to decline in accordance with the length-tension relation of the muscle.

Afterloaded contractions. Afterloaded contractions show an inflexion in the course of shortening when light loads are lifted early after stimulation. The inflexion in the shortening curves with the light afterloads is not unexpected if these loads are lifted before contractility is maximal. However, there appears to be some delay in attaining maximum velocity even with heavier loads. The significance of these late velocity maxima is most pertinent to force-velocity relations and will be discussed in a subsequent paper.

Freeloaded contractions. Freeloaded shortening responses are complicated by extreme changes in muscle length during the contraction, but it is significant that the inflexion in their shortening curves occurs at about the same time as under afterloaded conditions (150-200 msec after excitation).

Shortening velocity following a release to isotonic contraction. The merit of the experiments in which the muscle was released from an isometric to an isotonic contraction at a given load lies in that the load lifted by the muscle following each release is always the same, except for the small changes in the resting tension component which occur as the height of the undamped elastic shortening increases. However, despite an expected decline in shortening velocity as the contractile element load increases, the shortening velocity after the releases is greatest for releases given at about the same time as the inflexions appear in the afterloaded and free-loaded experiments, at about the same time as maximum redeveloped tension occurs, and at about the time the level of tension development following an appropriate quick stretch begins to show some sort of plateau. Thus, the five methods of study reported here all indicate a slow onset of contractility in cardiac muscle.

Time course of cardiac contractility

The most quantitative of these studies is that of the release from isometric to isotonic contraction with a given load. However, considerable reservation must be made in considering these responses as an index of the time course of contractility. First, the shortening velocity is not measured immediately after the release but 20 msec after the step, owing to the method of velocity measurement. The effect of this delayed measurement is to increase measured velocities early in the cycle where the slope of the velocity time course is positive and to decrease the measured velocities for late releases where the slope of the velocity trace is negative. Thus, if shortening velocities could be measured near the step, the onset of contractility (Fig. 9A) would appear steeper, but reach its maximum at about the same time and then decline more slowly than the curves indicate.

Another correction required is due to internal shortening in the isometric phase of contraction. As can be seen in Fig. 8, the step change in length upon release to a given load may be relatively large (in this case, 3% of the initial muscle length). This means that even during an isometric contraction, a significant reduction in contractile force, relative to the initial length, may occur as the contractile element shortens and stretches the series elastic element. On the other hand, the maximum shortening velocity (post-release velocity) measured after each release to a given load should give an indication of the state of contractility in the concomitant isometric contraction as internal shortening proceeds.

It would be conceivable that the apparent time-dependent onset of contractility is simply a reflexion of the negative slope characteristic of the active length-tension relation, if all experiments had been performed at muscle lengths greater than that at which peak isometric tension was

developed. However, the only case in which these lengths were encountered in the experiments reported here was with the quick stretches shown in Fig. 4. Indeed, actively developed tension was reduced with some of the larger stretches, but active tension increased following the stress relaxation of each stretch whether or not the length change carried the muscle into the negative slope region of the length-tension relation. Since all the other types of experiments performed at shorter lengths also indicate a slow onset of contractility, this possibility is untenable.

Effect of release on contractility. If the release itself does not affect the onset and decay of contractility during a twitch, then it would be expected that the time of maximum PRV should be independent of load. In Fig. 9B, some time variation of the maxima is apparent but the curves are broad and flat in the range concerned and the variation may not be significant. In Fig. 9A, however, the decline of PRV after the maximum is fairly steep, so that by the time peak tension would have been reached in an isometric contraction, the ability of the muscle to shorten against the same load has fallen to 2/3 its maximum value. While it is tempting to define this PRV-release time plot as a measure of the active state, such an interpretation must be made with some reservation. Several types of experiments (which will be reported in detail in a later paper) show that muscle shortening occurring after PRV reaches its maximum tends to reduce contractility in addition to the decline of contractile force with shortening expected from the length-tension relation. For example, in Fig. 8, if the release had occurred in the relaxation phase, say, after curve *g* has returned to the base line, the muscle could still lift the load and actively shorten considerably beyond the undamped elastic step. In other words, the persistence of isometric tension tends to maintain the ability of the muscle to do work as recently reported in skeletal muscle (Hill, 1964). Thus, the PRV-release time plot (Fig. 9A) probably does not represent the same time course of contractility as that occurring in the isometric contraction where contractile force is the index of contractility.

Starling's Law of the heart

It is interesting that the time course of tension development following a stretch is dependent only on the magnitude of the stretch and not on the velocity or the time of the stretch so long as the stretch occurs either before or within 150–200 msec after excitation (Figs. 2A, 3). With later stretches, the extent of slippage increases with increased velocity or magnitude of the stretch. Relating these findings to the whole ventricle it would be expected that volume changes (applied externally) imposed upon a ventricle perhaps as late as the onset of ventricular ejection would result in ventricular pressures consistent with Starling's Law. The ventri-

cular pressure concomitant with volume changes imposed after this period, however, would be expected to be less appropriate to the new volume because of excessive slippage in the contractile element.

Basis of slow onset of contractility

Asynchronous excitation. A slow onset of contractility might be explained by a slow propagation of excitation along the cellular membranes. The effect of the stimulus was investigated by releasing the muscle and allowing it to shorten against a given load during responses produced by (i) a supra-threshold stimulus applied with massive electrodes, and (ii) a threshold applied at one end of the muscle with point electrodes. The rate of tension development during the isometric phase preceding the release was significantly increased by massive stimulation so that at the time of the release the undamped step was increased. The shortening velocities following the step, however, were about the same in each case.

Two opposing effects could be responsible for the unchanged shortening velocity. The shortening velocity after the release would tend to rise as a result of the more synchronous excitation, but the reduced muscle length at which isotonic shortening begins when the muscle is stimulated massively could annul this tendency. While these experiments are indecisive with respect to the shortening velocity, they do indicate that the manner of stimulation used is unlikely to be the sole basis of the slow onset of contractility. However, these results do not eliminate the possibility of a slow or asynchronous intracellular activation of contractile sites.

Diffusion. The mechanism underlying the slow rate of tension manifestation in heart muscle might be sought in a long diffusion pathway between the plasma membrane and the contractile element. A calculation of the diffusion time similar to that of Hill (1948, 1949) and Niedergerke (1963) shows that only 10 msec would be required for a coupling substance diffusing in from the plasma membrane to reach 90% equilibration at the centre of the fibers. Thus, a diffusion delay cannot be the cause of the slow onset of contractility in heart muscle.

It is conceivable that the slow onset of contractility relative to skeletal muscle might be related in some way to the lesser prominence of the sarco-reticular network in heart muscle (Porter & Palade, 1957). Since the diffusion distance is not a limiting factor some other aspect of the coupling mechanism must be involved. It is well known that the rate of onset of isometric contraction in the heart is strongly temperature dependent (Heintzen, Kraft & Weizmann, 1956). Thus, it is more likely that the slow manifestation of contractility in heart reflects the kinetics of a metabolic process possibly involving the sarco-reticular network.

The author wishes to express his gratitude to Dr W. F. H. M. Mommaerts for his encouragement and advice during the development of this work and for his criticism of the manuscript, to Mr Charles Dubkin for his technical assistance with the experiment, and to Mr Myron Schilling for the design and construction of the apparatus. This work was done during the tenure of an Established Investigatorship of the American Heart Association. This work was supported by Research Grant no. 60 F 7EG of the American Heart Association, Public Health Grant no. HE-03067 and National Service Foundation Grant no. G-13074.

REFERENCES

- ABBOTT, B. C. & MOMMAERTS, W. F. H. M. (1959). A study of inotropic mechanisms in the papillary muscle preparation. *J. gen. Physiol.* **42**, 533-551.
- BLINKS, J. R. & KOCH-WESER, J. (1963). Physical factors in the analysis of the actions of drugs on myocardial contractility. *Pharmac. Rev.* **15**, 531-599.
- BRADY, A. J. (1964). Development of tension in cardiac muscle. In: *Pharmacology of Cardiac Function*, ed. KRAYER, O., vol. 5, pp. 15-23. IInd International Pharmacology Meeting, Pergamon Press, Praha: Czechoslovak Medical Press.
- BRADY, A. J. (1965). Time and displacement dependence of cardiac contractility: problems in defining the active state and force velocity relations. *Fedn Proc.* **24**, 1410-1420.
- HEINTZEN, P., KRAFT, H. G. & WIEGMANN, O. (1956). Über die elektrische und mechanische Tätigkeit des Herzstreifenpräparates vom Frosch in Abhängigkeit von der Temperatur. *Z. Biol.* **108**, 401-411.
- HILL, A. V. (1938). The heat of shortening and the dynamic constants of muscle. *Proc. R. Soc. B*, **126**, 136-195.
- HILL, A. V. (1948). On the time required for diffusion and its relation to processes in muscle. *Proc. R. Soc. B*, **135**, 446-463.
- HILL, A. V. (1949). The abrupt transition from rest to activity in muscle. *Proc. R. Soc. B*, **136**, 399-420.
- HILL, A. V. (1964). The effect of tension in prolonging the active state in a twitch. *Proc. R. Soc. B*, **159**, 589-595.
- JEWELL, B. R. & WILKIE, D. R. (1960). The mechanical properties of relaxing muscle. *J. Physiol.* **152**, 30-47.
- MACHIN, K. E. & PRINGLE, J. W. S. (1959). The physiology of insect fibrillar muscle. II Mechanical properties of a beetle flight muscle. *Proc. R. Soc. B*, **151**, 204-225.
- NIEDERGERKE, R. (1963). Movements of Ca in beating ventricles of the frog heart. *J. Physiol.* **167**, 551-580.
- PORTER, K. R. & PALADE, G. E. (1957). Studies on the endoplasmic reticulum. III. Its form and distribution in striated muscle cells. *J. biophys. biochem. Cytol.* **3**, 269-300.
- SCHILLING, M. O. (1960). Capacitance transducers for muscle research. *Rev. scient. Instrum.* **31**, 1215-1217.
- SONNENBLICK, E. H. (1964). Series elastic and contractile elements in heart muscle: changes in muscle length. *Am. J. Physiol.* **207**, 1330-1338.