

# PHOTOALTERATION OF CALCIUM CHANNEL BLOCKADE IN THE CARDIAC PURKINJE FIBER

M. C. SANGUINETTI AND R. S. KASS

*University of Rochester, School of Medicine and Dentistry, Rochester, New York 14642*

**ABSTRACT** Organic compounds that block calcium channel current (calcium antagonists) are important tools for the characterization of this channel. However, the practically irreversible nature of this block restricts the usefulness of this group of drugs. In this paper, we investigate the influence of light on calcium channel blockade by several organic compounds. Our results show that inhibition of calcium channel current by two dihydropyridine derivatives that contain an *o*-nitro moiety (nisoldipine and nifedipine) can be rapidly reversed by illumination. The energy range important to this reaction is for light wavelengths between 320 and 450 nm. Calcium channel inhibition by two other dihydropyridine derivatives (nicardipine and nitrendipine) as well as by D600, is not modulated by illumination. These results indicate that the photosensitivity of certain dihydropyridine calcium channel blockers makes these compounds useful as reversible blockers of this channel.

## INTRODUCTION

Calcium channels exist in a wide variety of cells and participate in many aspects of cellular function (Hagiwara and Byerly, 1981; Fenwick et al., 1982; Tsien, 1983; Reuter, 1983). In many of these cells ion flow through these channels can be inhibited by several organic and inorganic compounds (Henry, 1980; Lee and Tsien, 1983). These compounds are referred to as "Ca antagonists" (Fleckenstein, 1977) or "Ca channel blockers" (Triggle, 1982). Quantitative investigation of the properties of calcium channels in any cell type often requires selective and complete block of ion movement through these channels. Complete block of calcium channel current reveals a background current that is not necessarily a linear function of membrane potential (Brown et al., 1981). Subtraction of the background current can be accomplished by forming the difference between traces measured in the absence and presence of a maximal concentration of blocker. This procedure has already been used to investigate the calcium channel reversal potential in *Helix aspersa* (Brown et al., 1981) and cardiac ventricular cells (Lee and Tsien, 1982), as well as to describe a component of calcium channel current that fails to completely inactivate during prolonged depolarizations in the cardiac Purkinje fiber (Kass et al., 1976).

The advantage of using the organic inhibitors in these experiments is that some of these compounds tend to be more selective for the calcium channel than the inorganic blockers (Kass and Tsien, 1975). The disadvantage of organic blockers is that they are practically irreversible or are so only after prolonged periods of washout presumably due to their extremely lipophilic nature. Experiments designed to investigate the modes of action of these com-

pounds on the calcium channel frequently require observation of changes in calcium channel current brought on by low concentrations of these inhibitors.

Measurement of changes in current due to low concentrations of drug are also essential for determining the relative blocking potency of these compounds. This in turn will provide crucial information for comparison with binding studies (Bolger et al., 1982; Ehlert et al., 1982) in attempts to count and purify calcium channels. Without a reversible inhibitor, it is impossible to distinguish between drug-induced reduction in this current and that due to run-down of the preparation (for example see Fenwick et al., 1982).

Nisoldipine and nifedipine are two dihydropyridine compounds that block calcium channel current and are known to deteriorate when exposed to light (Miles Laboratories, product information; Ebel, et al., 1978). The purpose of these experiments is to determine whether the light sensitivity of these compounds might render them useful as reversible organic calcium channel blockers. Our results indicate that inhibition of calcium channel current by nisoldipine and nifedipine, but not by some other dihydropyridine derivatives that we studied, can indeed be effectively and rapidly reversed by illumination. Some of these results have been briefly reported to the Biophysical Society (Kass and Sanguinetti, 1983).

## METHODS

Hearts were obtained from calves at a local slaughterhouse and transported to the laboratory in cold (4°C) Tyrode's solution continuously gassed with 100% O<sub>2</sub>. Transport time from removal of the heart from the animal to arrival in the laboratory averaged 15 min. Shortened (0.5–1.5 mm) Purkinje fibers (100–200 μm diam) were excised from either

ventricle and placed in warm (35°C) oxygenated Tyrode's solution until used.

Membrane current was measured using a conventional two microelectrode voltage clamp technique (Siegelbaum and Tsien, 1980). Current signals were filtered at 1 kHz, digitized, and recorded on a PDP-1123 computer (Digital Equipment Corp., Marlboro, MA). Electrodes were pulled from thin walled omega-dot glass (Glass Company of America, Bargaingtown, NJ) and then beveled using a modified spin-bar beveler (Corson et al., 1979).

All action potential experiments were carried out at a 0.2-Hz drive rate. Action potentials were stimulated steadily at this rate before, during, and after application of drug (in the dark). Stimulation was continued at this rate while the light beam was turned on. In all voltage clamp experiments, calcium channel current was measured by applying depolarizing voltage pulses from a fixed holding potential at a fixed pulse frequency (0.2–0.25 Hz). In any given experiment, pulse rate was constant and steady before, during, and after applying a drug in the dark. The same rate was maintained while the light beam was turned on. Thus, in any given experiment, the interpulse interval was always the same during control conditions and after exposure to drug ( $\pm$ light). Current-voltage curves were determined by measuring membrane current after the capacity transient had settled following the imposed change in membrane potential.

### Light Source

The light source was a 100-W tungsten bulb (Klinger Scientific Corp., Richmond Hill, NY). The lamp was powered by a 12 V DC storage battery. Light from the lamp was passed through an infrared rejection filter (Eastman Kodak Co., Rochester, NY) to eliminate possible temperature-dependent effects. The light beam was then collimated via a two slit Kohler arrangement, and appropriate wavelengths were chosen by passing the beam through long pass cut-on filters (Oriel Corp., Stamford, CT). The filtered beam was then focused onto a preparation with a long working distance 20X (0.33 numerical aperture) microscope objective (Nikon Inc., Instrument Div., Garden City, NY). The size of the focused beam could be selected by adjusting one of the collimating slits (see Kass, 1981 for optical arrangement).

Tests for local temperature changes were carried out by placing a small thermistor (#UUT51J1, Fenwall Electronics, Farmingham, MA) in the chamber directly in line with the light source. These tests confirmed that the infrared rejection filter prevented local heating of the Tyrode's solution (and thus the fiber) by the light source. With this filter in place local temperature was controlled to within  $\pm 0.5^\circ\text{C}$ .

### Absorption Spectrophotometry

Absorption spectra for solutions of the dihydropyridine compounds were measured over a limited region of ultraviolet and visible light with a spectrophotometer (model 25; Beckman Instruments, Inc., Fullerton, CA). The drugs were dissolved in optical grade methanol and the absorption spectrum was determined for each drug before and after illumination with the tungsten-halogen lamp.

### Solutions and Drugs

The standard modified Tyrode's solution contained 150 mM NaCl, 4 mM KCl, 5.4 mM  $\text{CaCl}_2$ , 0.5 mM  $\text{MgCl}_2$ , 5 mM glucose, and 10 mM Tris (pH 7.4). In voltage clamp experiments, iontophoretic injection of tetrabutylammonium (TBA) was performed to reduce the transient outward current ( $I_{\text{to}}$ ) and the delayed rectifier,  $I_r$  (Kass et al., 1982).  $I_{\text{Na}}$  was inhibited by tetrodotoxin (TTX, 10  $\mu\text{M}$ ) or inactivated by choice of holding potential. In some experiments  $\text{CaCl}_2$  was replaced with 5.4 mM  $\text{SrCl}_2$  to enhance calcium channel current. All solutions were gassed with 100%  $\text{O}_2$ .

Temperature was regulated with a thermoelectric device (Cambion,

Cambridge, MA) over a range of 34–37°C, but held constant during a given experiment to within  $\pm 0.5^\circ\text{C}$ . Nisoldipine, nitrendipine, and nifedipine were dissolved in polyethylene glycol 400 in stock concentrations of 10 mM. Aliquots of these stock solutions were added directly to the Tyrode's solution to achieve final desired concentrations. Nicardipine and D600 stock solutions were prepared using distilled water as a solvent. Experiments were performed under light filtered through a safelight filter 00 (Eastman Kodak Co.).

Nisoldipine and nitrendipine were kindly supplied by Miles Laboratories (West Haven, CT). Nicardipine was a gift from Syntex (Palo Alto, CA), and D600 was kindly provided by Knoll Pharmaceutical (Ludwigshafen and Rhein, Federal Republic of Germany). TBA chloride was purchased from Sigma Chemical Corp. (St. Louis, MO), and TTX was obtained from Calbiochem-Behring Corp., (American Hoechst Corp., San Diego, CA). Data are expressed as means  $\pm$ SEM ( $n$  equals the number of experiments).

## RESULTS

### Action Potential Studies: Light Can Modulate Calcium Antagonist Suppression of the Plateau

At micromolar concentrations, nisoldipine (applied under subdued illumination) (Kass, 1982) and other calcium antagonists (Kass and Tsien, 1975) dramatically lower and shorten the plateau phase of the Purkinje fiber action potential. The effects caused by exposure to nisoldipine (10  $\mu\text{M}$ ) can be effectively reversed by focusing a beam of light on the preparation for  $\sim 5$  min (Fig. 1 A). This effect is observed even if drug superfusion is uninterrupted during illumination. When the light beam is turned off and the fiber continues to be superfused with drug, the effects of nisoldipine redevelop in  $\sim 7$  min (not shown). These changes appear to be due to an interaction of light with the drug molecule as exposure to light alone had no effect on the action potential in five preparations. These results are consistent with known properties of nisoldipine as it is known to deteriorate in sunlight (half-life under 10 min, Miles Laboratory product information). Similar results were obtained when fibers were treated with nifedipine and subsequently illuminated.

In contrast, other dihydropyridine calcium antagonists, nitrendipine and nicardipine, are not as sensitive to sunlight. For example, in sunlight nitrendipine has a half-life of 5–35 h (Miles Laboratories product information). Similarly, exposure of a 0.5% solution of nicardipine in water to sunlight for 24 h results in only 2% degradation (Dr. L. Sanders, personal communication). Thus, as expected, illumination of fibers treated with nitrendipine (Fig. 1 B) or nicardipine (not shown) did not reverse the effects of these drugs on the Purkinje fiber action potential plateau.

The influence of light on the interaction of these drugs with the action potential suggested that illumination might modulate calcium channel blockade by nisoldipine and nifedipine, but not by the other dihydropyridine compounds. Voltage clamp experiments were carried out to test this possibility more directly.

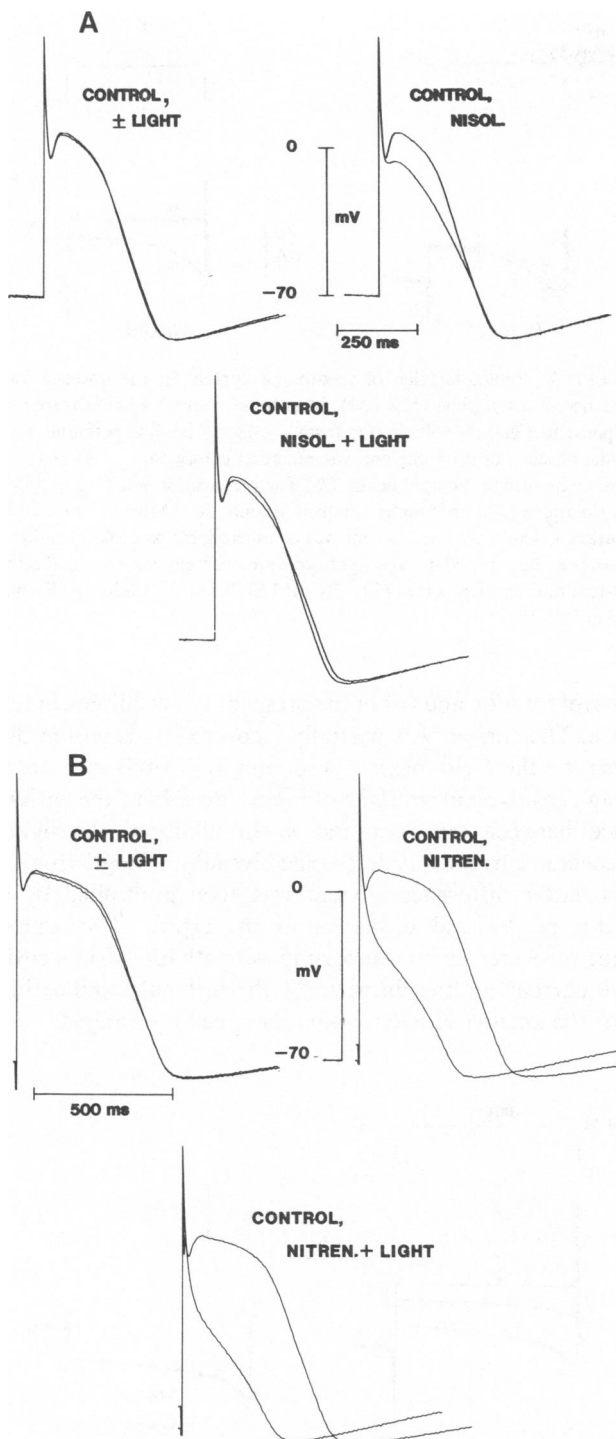

FIGURE 1 Effect of illumination on the Purkinje fiber action potential in the absence and presence of dihydropyridine calcium antagonists. (A) The left-hand records show superimposed action potentials recorded before and after a 10-min exposure to the light beam when no drug was present. Then the chamber was superfused with  $10 \mu\text{M}$  nisoldipine. After 12 min, the drug had markedly lowered and shortened the plateau phase of the action potential (right traces). Illumination of the preparation for 10 min restored the action potential towards its original configuration (lower traces). Preparation 276-2. (B) A similar sequence was carried out with  $10 \mu\text{M}$  nitrendipine. In this case, records are shown after a 20-min exposure to the drug (right panel), and subsequent illumination had no effect on the action potential (lower traces). Preparation 282-4.

## Voltage Clamp Studies: Influence of Light on Calcium Channel Block

**Nisoldipine.** Fig. 2 shows the effects of nisoldipine on calcium channel current before and after an 8-min exposure to the light beam. Voltage steps were applied to a series of test potentials from a holding potential of  $-50$  mV, and currents were measured after the capacity transient had settled. In the absence of drug, calcium channel current contributes inward current at voltages more positive than  $-40$  mV, and this inward current is completely blocked after a 15-min exposure to  $500$  nM nisoldipine. This block was effectively reversed by subsequent exposure to the light beam as the figure indicates. In this experiment,  $\sim 83\%$  of the current blocked by nisoldipine was recovered by illumination. This result is typical of 12 other experiments, but the percent of drug-blocked current recovered by light was variable and relatively insensitive to drug concentration. The results of these experiments,

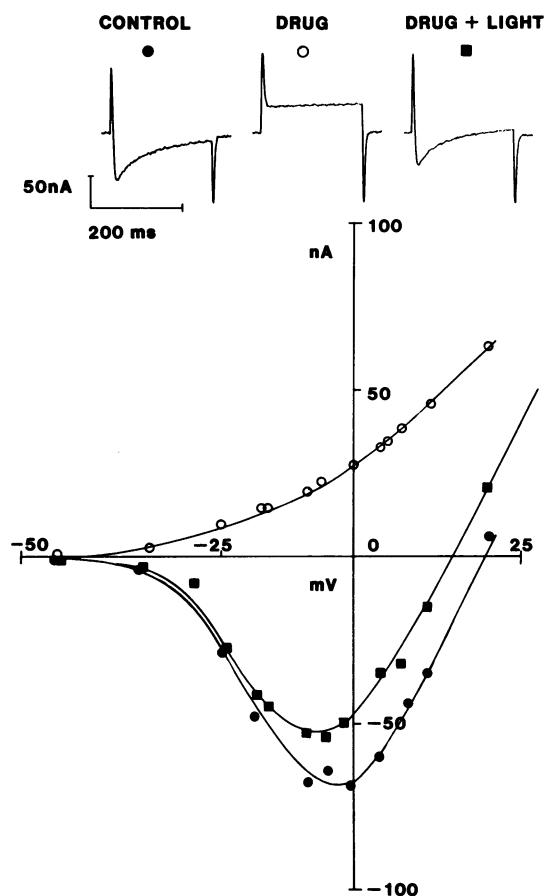

FIGURE 2 Light modulates inhibition of calcium channel current by nisoldipine. Inset: Membrane current recorded in response to voltage steps to  $-1$  mV from a  $-42$  mV holding potential in the absence of drug ( $\bullet$ ), after an 18-min exposure to  $500$  nM nisoldipine ( $\circ$ ) and then in the presence of this drug concentration but after illuminating the preparation for 8 min ( $\blacksquare$ ). Current-voltage curves were determined in each case as described in Methods. The curves in the figure are hand-drawn.  $5.4$  mM  $\text{Sr}^{2+}$ -Tyrode's solution. Preparation 300-3.

summarized in Table I, confirm the action potential studies.

These experiments were designed to test for changes in drug-induced blockade of the calcium channel brought on by exposure to light. Thus, as a control it was necessary to determine whether light affects calcium channel current in the absence of drug. To test for this possibility, we measured peak inward current in response to voltage steps to potentials near 0 mV from  $-50$  to  $-45$  mV holding potentials before and after a 5-min exposure to the light beam. No change in current was seen under these conditions in 13 of 20 fibers studied. But in the remaining seven fibers we did observe an increase ( $31 \pm 7\%$ ) in inward current.

Fig. 3 shows the effects of nisoldipine on calcium channel current before and after illumination in a fiber showing photosensitivity in the absence of drug. *A* shows that in this experiment, exposure to light in the absence of drug resulted in a 19% increase in peak inward drug-sensitive current. *B* shows that after complete block of calcium channel current by 500 nM nisoldipine in the dark, 80% of the control current is recovered by illumination. Thus, as was the case in our action potential studies, the light-induced recovery of blocked current appears to be due primarily to an interaction of light with the drug molecule.

The voltage dependence of the light-recovered peak inward current (Fig. 2, ■) is similar to that of the drug-free current (Fig. 2, ●). Because this voltage dependence is largely due to the relationship between the steady state activation of this channel and voltage (Reuter, 1979), this result suggests that the voltage-dependence of calcium channel activation is not altered after drug block is reversed by light.

We next tested for possible changes in inactivation of light-recovered calcium channel current under these conditions. Such tests are important as it has been reported that some dihydropyridines alter the kinetics of calcium channel inactivation in cardiac cells (Lee and Tsien, 1983). A simple test for a change in the kinetics of calcium current inactivation is shown in Fig. 4. *A* shows current measured in response to a voltage step to  $+18$  mV recorded in (*a*)

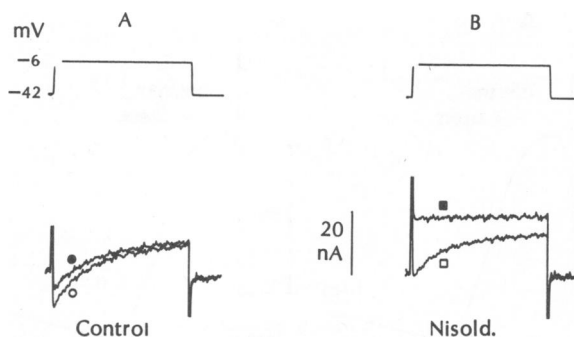

FIGURE 3 Photoalteration of membrane current in the absence and presence of nisoldipine (500 nM). Membrane current was measured in response to a 200-ms voltage step from a  $-42$  mV holding potential. (*A*) In the absence of drug current was recorded before (●) and after (○) a 7-min exposure to the light beam. (*B*) The preparation was then exposed to nisoldipine (500 nM) under subdued illumination. After 12 min in this solution, calcium channel current was completely blocked (■). The light beam was then turned on, and light-recovered current was recorded after a 7-min illumination period (□). 5.4 mM  $\text{Sr}^{2+}$ -Tyrode's solution. Preparation 300-2.

control solution and (*b*) in the presence of nisoldipine in the dark. The current was partially recovered by exposing the fiber to the light beam for 6 min (*c*). In *B*, the total drug-sensitive current was obtained by taking the difference between traces *a* and *b*. In addition, the light-recovered current was determined by subtracting *b* from *c*. The latter difference current was then multiplied by a factor of 2.5 and displayed in the figure. The scaled light-recovered current superimposes with total drug-sensitive current for the duration of the test pulse indicating that the kinetics of inactivation remained unchanged.

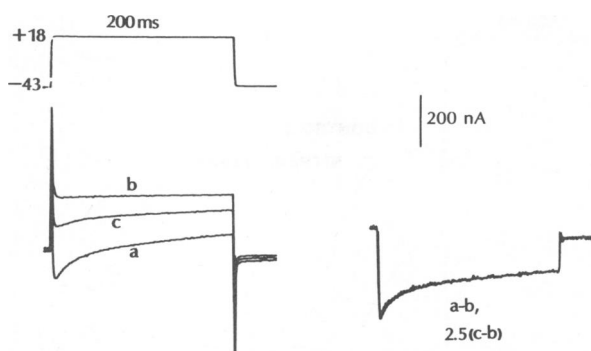

FIGURE 4 Inactivation kinetics of light-recovered current remains unchanged. The *left* panel shows membrane current recorded (*a*) before and (*b*) after exposure to nisoldipine (500 nM) in the dark. The preparation was then exposed to the light beam for 6 min and *c* was recorded. Total current blocked by the drug in the dark was obtained from the difference between *a* and *b* (*a-b*, *right* panel). The current recovered from drug block by light exposure was obtained from the difference between *b* and *c*, (*c-b*). This latter difference was then multiplied by a scale factor of 2.5 and also displayed on the *right*. The scaled light-recovered current superimposes with the drug-blocked current for the duration of this test pulse. 5.4 mM  $\text{Sr}^{2+}$ -Tyrode's solution. Preparation 301-1.

TABLE I  
BLOCK OF CALCIUM CHANNEL CURRENT BY  
NISOLDIPINE AND PERCENT RECOVERED BY  
ILLUMINATION

[Nisoldipine]	Percent of current blocked by nisoldipine	Percent of blocked current recovered by light	Range	<i>n</i>
10 $\mu\text{M}$	100%	$65 \pm 10\%$	20-100%	8
500 nM	100%	$64 \pm 5\%$	50-72%	4
200 nM	$63 \pm 8\%$	$73 \pm 10\%$	50-100%	4
100 nM	50%	80, 100	—	2

Holding potential was between  $-42$  and  $-55$  mV.

## Compounds Not Affected by Light

Our results with action potentials suggested that several compounds that block calcium channel current might not be affected by light. Calcium channel block by nitrendipine (Fig. 5 A) and D600 (Fig. 5 B) was not reversed by prolonged illumination.

### Wavelength Dependence of the Effect of Light on Nisoldipine

Ebel et al. (1978) determined by several analytical techniques that nifedipine was converted to a nitroso pyridine derivative when illuminated for 10 min with a 300-W light source. The peak of the absorption spectrum of this pyridine derivative was shifted to shorter wavelengths compared with nifedipine. For comparison, we determined the absorption spectrum of nisoldipine (in methanol) over a similar range of the ultraviolet and visible electromagnetic spectrum before and after illumination with our light source. As shown previously for nifedipine by Ebel et al. (1978) the peak of the absorption spectrum of nisoldipine was also shifted to shorter wavelengths after exposure to light (Fig. 6 A, B). The light-induced change in the absorption spectrum suggested that light of wavelengths shorter than 450 nm would be the effective energy range that converts nisoldipine to its inactive form as a calcium channel blocker.

The absorption spectrum of a nitrendipine solution was not altered by illumination (not shown). The absence of

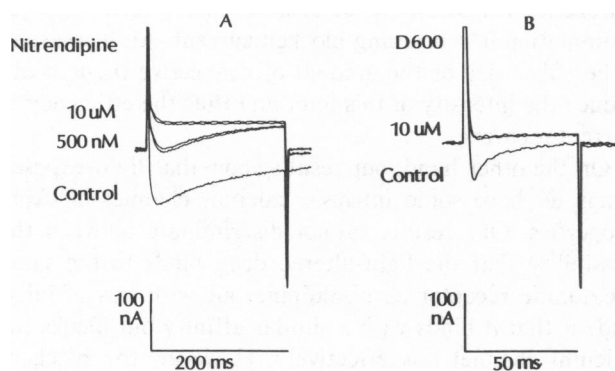

FIGURE 5 Calcium channel current blockade by nitrendipine or by D600 is not altered by light. (A) The figure shows membrane current in response to a voltage step to +2 mV from a -55 mV holding potential in the absence and presence of 500 nM and 10 μM nitrendipine. During exposure to each drug concentration, the fiber was illuminated for 10 min and traces that were then obtained are also shown. Nitrendipine continued to further block inward current even in the presence of light, and the resulting traces are subsequently more outward in each case. 5.4 mM Sr<sup>2+</sup>-Tyrode's solution. Preparation 313-1. (B) A similar protocol was followed using 10 μM D600. The figure shows membrane current in response to a voltage step to -3 mV from a -52 mV holding potential in the absence and presence of D600, and in the presence of D600 after a 10-min exposure to the light beam. The D600 traces superimpose before and after illumination. 5.4 mM Ca<sup>2+</sup>-Tyrode's solution. Preparation 280-4.

photoalteration is consistent with the inability of light to reverse calcium channel block by nitrendipine.

We then determined the energy dependence of the light-induced reversal of nisoldipine's block of calcium channel current. Light of a specified range was selected by placing a wide band long-pass filter between the light source and the focusing lens. These filters transmit wavelengths longer than a characteristic "cut-on" frequency and block light of lower wavelengths. The results showed that light at wavelengths  $\geq 450$  nm was not effective in converting nisoldipine to its less active form. It is not likely that light at wavelengths shorter than 325 nm contributes significantly to the modulation of nisoldipine's inhibition of calcium channel current in our experiments since the power output of our quartz halogen lamp falls off very steeply between 450 nm and 300 nm (Oriol Corp., product information) and, in addition, light in this energy is further attenuated by glass and plastic components of the optical system.

### Relative Blocking Potency of Nisoldipine That is Exposed to Light

Illumination of the fiber after exposure to nisoldipine usually only resulted in partial recovery of the current previously blocked by the drug (Table I). The question remained, therefore, whether the light source used was ineffective in altering enough of the nisoldipine in the chamber to render its blocking effect negligible within the fiber, or whether the light-exposed compound simply has a less potent calcium channel blocking activity. To test the hypothesis that the light-induced derivative of nisoldipine has some intrinsic Ca<sup>2+</sup>-channel blocking action, a stock solution of nisoldipine (10 mM) was dissolved in methanol and illuminated for 1 h with unfiltered light from the tungsten-halogen lamp. The yellow stock solution became transparent after light exposure and the same change in the absorption spectrum (as shown in Fig. 6) was produced. The stock solution was then diluted 1:1,000 in Tyrode's solution and superfused through the tissue chamber. The nisoldipine that had been exposed to light decreased peak inward current by 15% after 15 min. The same fiber was then exposed to 10 μM nisoldipine that had not been exposed to light and complete block of inward current occurred in 17 min (Fig. 7). In another experiment nisoldipine, similarly pre-exposed to light, blocked 13% of the drug sensitive inward current in 20 min. In 13 other experiments, 10 μM nisoldipine that had not been exposed to light blocked 30% of drug sensitive current in  $5.9 \pm 0.6$  min, and resulted in complete block in  $16.7 \pm 1.1$  min. Thus, it appears that the light-exposed drug molecule does have some activity as a calcium channel blocker, but much less than the activity of the drug that has not been exposed to light (wavelengths < 450 nm). This blocking activity of the light-treated compound could account for some of the current that was not recoverable ( $35 \pm 10\%$ ,  $n = 8$ ) by illumination after exposure to 10 μM nisoldipine.

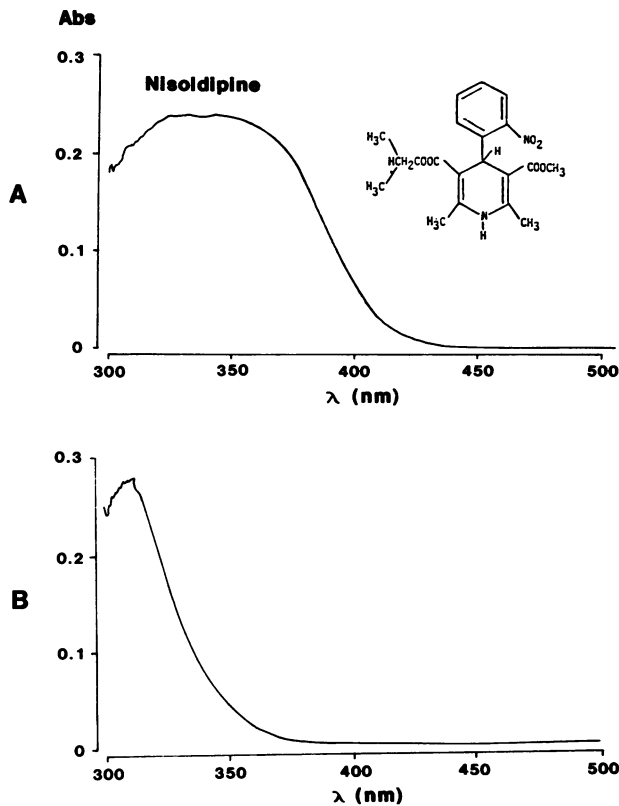

FIGURE 6 Ultraviolet and visible absorption spectra of  $5 \times 10^{-5}$  M nisoldipine (A) before and (B) after lumination of solution with tungsten-halogen lamp. There was no absorption at wavelengths  $> 500$  nm.

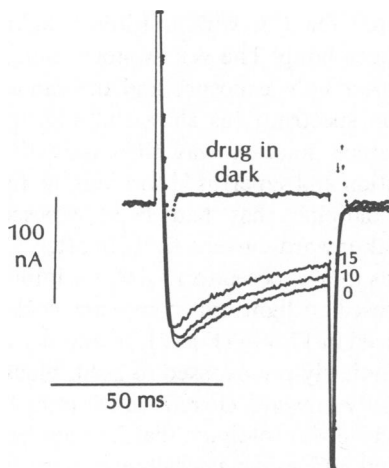

FIGURE 7 Effect of light-exposed nisoldipine on calcium channel current. Membrane current is shown in response to a voltage step to  $-1$  mV from a  $-48$  mV holding potential in the absence of drug (0) and 10 and 15 min after exposing the fiber to nisoldipine that had previously been exposed to the halogen light beam as described in the text. The upper trace (drug in dark), was then recorded 12 min after addition of nisoldipine ( $10 \mu\text{M}$ ) that had been stored in the dark. All records were obtained under subdued laboratory illumination as described in Methods.  $5.4 \text{ Sr}^{2+}$ -Tyrode's solution. Preparation 310-1.

## DISCUSSION

### Reversible Organic Calcium Channel Blockers

The results of this study indicate that calcium channel blockade by some, but not all, dihydropyridine derivatives, can be substantially modulated by illumination. The dihydropyridines with an *o*-nitrophenyl linked to the pyridine ring (nisoldipine and nifedipine) are very sensitive to light. In contrast, the dihydropyridine compounds with a *m*-nitrophenyl substituent (nitrendipine) are far less sensitive to light. Thus it seems that the *o*-nitrophenyl substituted dihydropyridines will be useful in studies where reversible block of the calcium channel is desired. In addition these compounds will be very useful as probes for localized calcium-dependent processes, since local illumination can be used to selectively reveal areas that contain calcium channels. Our observations in mammalian cardiac Purkinje fibers are similar to recent findings by Morad et al. (1983) in frog heart.

### Relative Potency of Light-exposed Nisoldipine

Exposure to light was not always 100% effective in reversing calcium channel inhibition by high nisoldipine concentrations. Some of this variability may be attributed to the considerable variation in fiber size and in the amount of collagen that surrounds the core of cells in a calf Purkinje fiber preparation. If nisoldipine acts at the inner surface of the cell membrane, then the intensity of light that reaches intracellular nisoldipine determines the effectiveness of illumination in recovering blocked current. An increase in either fiber size or the amount of connective tissue could reduce the intensity of this light and thus the efficiency of current recovery.

On the other hand, our results show that light-exposed drugs do have some intrinsic calcium channel blocking properties. Our results cannot discriminate between the possibility that the light-altered drug binds to the same membrane receptor as nisoldipine but with less affinity, and/or that it binds with a similar affinity but blocks the calcium channel less effectively. However, the block of calcium channel current by nisoldipine can be reversed by washout only if the fiber is simultaneously illuminated. This suggests that the light-altered drug binds with less affinity. Light-treated nisoldipine is a weak calcium channel current inhibitor but this should not limit the usefulness of light as a modulator of this blocker, especially if low drug concentrations ( $<200$  nM) are used.

### Comparison with Previous Structure-Activity Studies

Ebel et al. (1978) reported that nifedipine is converted to a nitroso-containing pyridine derivative when exposed to intense light. It has not been reported if conversion of the

*o*-nitro moiety to a nitroso derivative has any effect on potency of dihydropyridines. However, Rodenkirchen et al. (1978) have shown that the *o*-nitro substituent is nonessential for the characteristic action of nifedipine. The negative inotropic effect of the pyridine analogue of nifedipine is more than two orders of magnitude less potent than nifedipine (Mannhold et al., 1982). The pyridine analog of nifedipine is ~25% effective as a negative inotropic agent at a concentration that fully inhibits contraction of isolated papillary muscles exposed to an equimolar concentration (10  $\mu$ M) of nifedipine (Rodenkirchen et al., 1982; Mannhold et al., 1982).

We find that the relative potency of nisoldipine and the drug produced by exposing nisoldipine to light is similar to that shown for nifedipine and its pyridine derivative (Mannhold et al., 1982). Furthermore, the absorption spectra for the nisoldipine solution before and after exposure to the light source are similar to comparable spectra for nifedipine (Ebel et al., 1978). Thus, from our experiments it seems likely that nisoldipine is also converted to a pyridine derivative in light (also see Morad et al., 1983), and this derivative is ~20% as effective as nisoldipine in inhibiting calcium channel current.

#### Effects of Light in the Absence of Drug

We occasionally observed light-induced changes in the action potential or membrane current in the absence of drug. This effect was always in the direction of a light-induced increase in calcium channel current. This action could not have been caused by the presence of residual drug in the tissue chamber since considerable effort was made to clean the chamber between each experiment.

It is not clear why these changes occur, but the action spectrum for this effect is similar to that for the effect of light on drug-induced calcium channel blockade. Thus, light in the near ultraviolet region of the spectrum is responsible for this effect. UV light has been reported to alter sodium channel conductance in nerve (Oxford and Pooler, 1975; Fox and Stampfli, 1971) and contractile activity in cardiac muscle (Morad et al., 1983). But, as in the case of our experiments, the mechanism responsible for these changes is not clear.

In summary, we find that calcium channel blockade by the dihydropyridine compounds nifedipine and nisoldipine can be reversed by exposure to light. This procedure provides reversible organic calcium channel blockers that should prove to be valuable probes of the roles of calcium channels in many aspects of cellular function.

We thank Drs. Alexander Scriabine and Charles Cohen of Miles Institute for their support and Karen Vogt and Margot Hattler for their excellent secretarial work.

This work was supported by U. S. Public Health Service grant no. HL21922 and by a grant from Miles Laboratories, New Haven, CT.

Received for publication 20 July 1983 and in final form 20 December 1983.

#### REFERENCES

- Bolger, G. T., P. J. Gengo, E. M. Luchowski, H. Siegel, D. J. Triggle, and R. A. Janis. 1982. High affinity binding of a calcium channel antagonist to smooth and cardiac muscle. *Biochem. Biophys. Res. Commun.* 104:1604-1609.
- Brown, A. M., K. Morimoto, Y. Tsuda, and D. L. Wilson. 1981. Calcium current-dependent and voltage-dependent inactivation in *Helix aspersa*. *J. Physiol. (Lond.)* 320:193-218.
- Corson, D. W., S. Goodman, and A. Fein. 1979. An adaptation of the jet stream microelectrode beveler. *Science (Wash. DC)* 205:1302.
- Ebel, V. S., H. Schutz, and A. Hornitschek. 1978. Untersuchungen zur Analytik von Nifedipin unter besonderer Berücksichtigung der bei Lichtexposition entstehenden Umwandlungsprodukte. *Arzneim. Forsch.* 28:2188-2193.
- Ehlerl, F. J., E. Itoga, W. R. Roeske, and H. Yamamura. 1982. The binding of 3H nitrendipine to receptors for calcium channel antagonists in the heart, cerebral cortex, and ileum of rats. *Life Sci.* 30:2191-2202.
- Fenwick, E. M., A. Marty, and E. Neher. 1982. Sodium and calcium channels in bovine chromaffin cells. *J. Physiol. (Lond.)* 331:599-635.
- Fleckenstein, A. 1977. Specific pharmacology of calcium in myocardium, cardiac pacemakers, and vascular smooth muscle. *Annu. Rev. Pharmacol. Toxicol.* 17:149-166.
- Fox, J. M., and R. Stampfli. 1971. Modification of ionic membrane currents of Ranvier by UV-radiation under voltage clamp conditions. *Experientia.* 27:1289-1290.
- Hagiwara, S., and L. Byerly. 1981. Calcium channel. *Annu. Rev. Neurosci.* 4:69-125.
- Henry, P. D. 1980. Comparative pharmacology of calcium antagonists: nifedipine, verapamil and diltiazem. *Am. J. Cardiol.* 46:1047-1058.
- Kass, R. S. 1981. An optical monitor of tension for small cardiac preparations. *Biophys. J.* 34:165-170.
- Kass, R. S. 1982. Nisoldipine: a new, more selective calcium current blocker in cardiac Purkinje fibers. *J. Pharmacol. Exp. Ther.* 223:446-456.
- Kass, R. S., and M. C. Sanguinetti. 1983. Optical quenching of calcium current block in the cardiac Purkinje fiber. *Biophys. J.* 41(2, Pt. 2):309a. (Abstr.)
- Kass, R. S. T. Scheuer, and K. J. Malloy. 1982. Block of outward current in cardiac Purkinje fibers by injection of quaternary ammonium ions. *J. Gen. Physiol.* 79:1041-1063.
- Kass, R. S., S. Siegelbaum, and R. W. Tsien. 1976. Incomplete inactivation of the slow inward current in cardiac Purkinje fibres. *J. Physiol. (Lond.)* 263:127-128P.
- Kass, R. S., and R. W. Tsien. 1975. Multiple effects of calcium antagonists on plateau currents in cardiac Purkinje fibers. *J. Gen. Physiol.* 66:169-192.
- Lee, K. S., and R. W. Tsien. 1983. Mechanism of calcium channel block by verapamil, D600, diltiazem, and nitrendipine in single dialyzed heart cells. *Nature (Lond.)* 302:790-794.
- Lee, K. S., and R. W. Tsien. 1982. Reversal of current through calcium channels in dialyzed single heart cells. *Nature (Lond.)* 297:498-501.
- Mannhold, R., R. Rodenkirchen, and R. Bayer. 1982. Qualitative and quantitative structure-activity relationships of specific Ca antagonists. *Prog. Pharmacol.* 5(1):25-52.
- Morad, M., Y. E. Goldman, and D. R. Tenham. 1983. Rapid photochemical inactivation of Ca<sup>2+</sup> antagonists shows that Ca<sup>2+</sup> entry directly activates contraction in frog heart. *Nature (Lond.)* 304:635-638.
- Oxford, G. S., and J. P. Pooler. 1975. Ultraviolet photoalteration of ion channels in voltage-clamped lobster giant axons. *J. Membr. Biol.* 20:13-30.
- Reuter, H. 1983. Calcium channel modulation by neurotransmitters, enzymes and drugs. *Nature (Lond.)* 301:569-574.

- Reuter, H. 1979. Properties of two inward membrane currents in the heart. *Annu. Rev. Physiol.* 41:413-424.
- Rodenkirchen, R., R. Bayer, and R. Mannhold. 1982. Specific and nonspecific Ca antagonists. A structure-activity analysis of cardiodepressive drugs. *Prog. Pharmacol.* 5(1):9-23.
- Rodenkirchen, R., E. Moller, R. Mannhold, E. Bossert, and M. Meyer. 1978. QSAR-studies in the inotropic action of nifedipine-derivatives. *Naunyn-Schmiedebergs Arch. Pharmacol.* 302:R36.
- Siegelbaum, S. A., and R. W. Tsien. 1980. Calcium-activated outward current in calf cardiac Purkinje fibres. *J. Physiol. (Lond.)* 299:485-506.
- Triggle, D. J. 1982. Biochemical pharmacology of calcium blockers. In *Calcium Blockers: Mechanisms of Action and Clinical Applications*. S. F. Flaim, and R. Zelis, editors. Urban and Schwarzenberg, Baltimore. 121-134.
- Tsien, R. W. 1983. Calcium channels in excitable cell membranes. *Annu. Rev. Physiol.* 45:341-358.