

# Sensory and Pulmonary Irritation of Methyl Isocyanate in Mice and Pulmonary Irritation and Possible Cyanidelike Effects of Methyl Isocyanate in Guinea Pigs

by Y. Alarie,\* J. S. Ferguson,\* M. F. Stock,\* D. A. Weyel,\*  
and M. Schaper\*

Methyl isocyanate (MIC) was evaluated for sensory and pulmonary irritation in mice. MIC was found to be both a potent sensory and pulmonary irritant in this species. From these results, a safe level of exposure for a period of 8 hr was estimated to be about 0.02 ppm for humans. Guinea pigs were also exposed to MIC for a single 3-hr exposure at a concentration of 37 ppm. During exposure to MIC, coughing was observed in all animals. Pulmonary function was evaluated immediately following exposure and intermittently on the next 35 days using CO<sub>2</sub> challenges and flow-volume loops. Highly abnormal responses to CO<sub>2</sub> were observed immediately after exposure in all animals. Six of the eight animals exposed to MIC died. In the two survivors, an apparent recovery was seen during the 5 days following exposure, but a worsening effect was observed at days 21 and 28, with a partial recovery at day 35. The data clearly demonstrated that the primary pulmonary effect of MIC was one of airways obstruction. Oxygen uptake and carbon dioxide output were also measured in the guinea pigs following exposure to MIC. No evidence of a cyanidelike effect was observed, in contrast to a severe depression of oxygen uptake following exposure to hydrogen cyanide.

## Introduction

Only one published report (1) existed in the literature on the toxicity of inhalation exposure of methyl isocyanate (MIC) prior to the Bhopal incident of December 2-3, 1984. Some limited data were previously published (2), indicating a high level of acute toxicity, as well as dermal and corneal irritation. Recent reports have confirmed the high acute toxicity and irritation by this monoisocyanate (3,4,5). In Bhopal, a large quantity of MIC, estimated between 25 to 30 tons, was released and vaporized within a fairly short period of time (6,7). The effect on humans and animals within the vicinity of the plant was immediate (8). Severe irritation of the eyes, nose, and throat was followed by irritating cough, chest pain, sensation of choking, and death in the more severely affected individuals.

Studies were undertaken in our laboratory to first estimate the potency of MIC as a sensory and a pulmonary irritant. The estimations were made using well-defined bioassay models (3), which have been used to test some 40 other chemicals; thus, comparison of MIC

to these other chemicals could be made. Also, using another well-defined bioassay model, we undertook the assessment of the recovery process following a single high level exposure to MIC.

## Sensory and Pulmonary Irritation

The details of this investigation have already been published (3), and thus, only a brief summary of the methods used is given here.

## Methods

Sensory irritation of the upper respiratory tract causes a characteristic delay during exhalation, and thereby a decrease in respiratory rate (9). This bradypnea occurs reflexively from stimulation of the trigeminal nerve endings in the nasal mucosa. A standard method using body plethysmographs attached to an exposure chamber has been described and was used for exposing the animals and for monitoring respiratory patterns (10). Swiss-Webster mice were used as the experimental animals, and groups of four mice were exposed to MIC at 0.5 to 7.6 ppm for 90 min. Their respiratory rate was measured prior to exposure (control period) and during exposure. The maximum de-

\*The Toxicology Laboratory, Department of Industrial Environmental Health Sciences, Graduate School of Public Health, University of Pittsburgh, Pittsburgh, PA 15261.

crease in respiratory rate was recorded for each exposure concentration and expressed as percent of control. The control value was taken as the average respiratory rate of each group prior to exposure. The maximum decrease in respiratory rate vs. the logarithm of the exposure concentration was plotted to develop a concentration-response relationship. From this relationship, the concentration necessary to evoke a 50% decrease in respiratory rate ( $RD_{50}$ ) was calculated.

Irritation of the lower respiratory tract in mice causes a characteristic pause between the end of expiration and the next inspiration (11). However, to evoke this response, mice must be fitted with a tracheal cannula to bypass the upper respiratory tract to prevent the trigeminal reflex due to sensory irritation as described above. Thus, mice were first anesthetized, and following a skin incision in the neck, the trachea was cut and a

polyethylene tube was inserted and secured. Skin sutures were made to hold the cannula firmly. The animals were placed in the body plethysmographs that were attached to the exposure chamber. Once the mice recovered from anesthesia (respiratory frequency almost back to the level of control mice), exposure to MIC was initiated. Again, a concentration-response relationship was obtained, from which the concentration necessary to reduce the respiratory rate by 50% in these tracheally cannulated mice ( $RD_{50TC}$ ) was calculated.

Exposure concentrations of MIC were obtained by passing dry air over 10 mL of MIC held in a 500 mL bottle submerged in an ice bath to keep the temperature at 0°C. The exposure concentration was determined by drawing samples from the exposure chamber with a gas-tight syringe, followed by direct injection on a gas chromatograph equipped with a nitrogen-phosphorus detector. The full details of the generation system and analytical procedures have been presented (3).

## Results

The action of MIC on the respiratory pattern of normal mice indicated that sensory irritation was present, as shown in Figure 1. At the higher concentrations, the breathing pattern revealed a mixed effect of sensory and pulmonary irritation toward the end of the 90-min exposure period in a few animals (Fig. 1). In mice fitted with a tracheal cannula, the breathing pattern indicated that pulmonary irritation was present (Fig. 1). From the concentration-response relationships obtained in normal mice and in mice fitted with tracheal cannulas, the  $RD_{50}$  and  $RD_{50TC}$  were determined to be 1.3 and 1.9 ppm, respectively.

## Discussion

**Potency of MIC as a Sensory Irritant.**  $RD_{50}$  values have been published for 40 industrial chemicals (12). An abbreviated list is given in Table 1, including acetone, the least potent chemical, and 2,4-toluene diisocyanate (TDI), the most potent chemical, permitting comparisons to be made with MIC. It is clear that MIC is a potent sensory irritant. To date, only 2,4-toluene diisocyanate has been found to be more potent than MIC (0.2 ppm vs. 1.3 ppm).

Table 1.  $RD_{50}$  values found in Swiss-Webster mice for different industrial chemicals.\*

Chemicals	$RD_{50}$ , ppm
Acetone	77,516
Acetaldehyde	4,946
Dimethylamine	511
Ammonia	303
Sulfur dioxide	117
Chlorine	9.3
Formaldehyde	3.1
Acrolein	1.7
Methyl isocyanate	1.3
2,4-Toluene diisocyanate	0.2

\*  $RD_{50}$  values are from Alarie (11) except for methyl isocyanate.

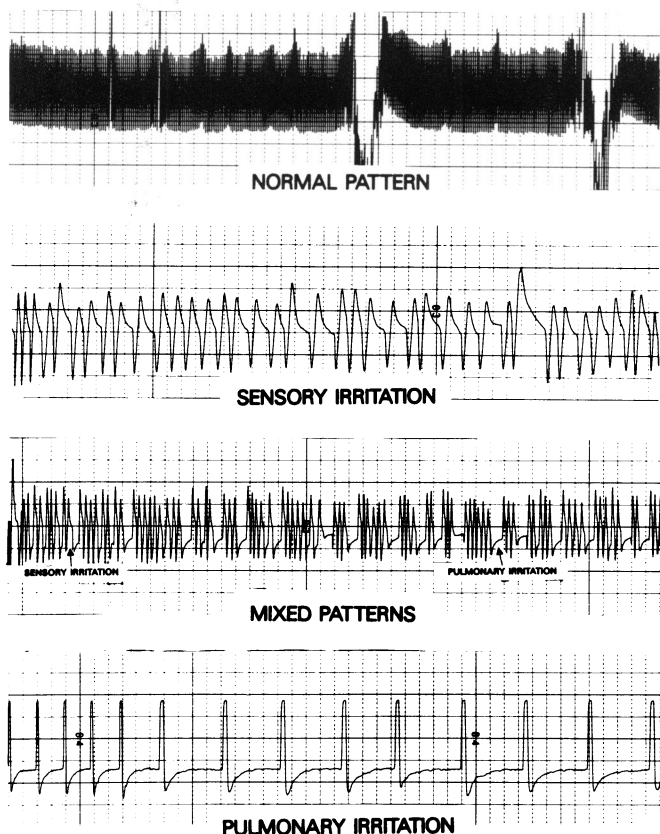

FIGURE 1. Respiratory patterns in mice, recorded at the same oscillograph speed for comparison among groups. First tracing: obtained in normal mice. A slightly reduced respiratory frequency is usually observed in mice fitted with a tracheal cannula, but is too small to change this pattern. Second tracing: characteristic pattern obtained with sensory irritants, showing a lengthening of expiration, taken from one animal exposed to MIC. Third tracing: characteristic pattern of sensory irritation but with some indication of pulmonary irritation, taken from one animal exposed to MIC. Fourth tracing: characteristic pattern of pulmonary irritation, showing a pause between the end of expiration and the beginning of inspiration, taken from one animal fitted with a tracheal cannula, during exposure to MIC. From Ferguson et al. (3). (Reprinted with permission from Academic Press.)

**Potency of MIC as a Pulmonary Irritant.**  $RD_{50}TC$  values have been published for several industrial chemicals (11), as listed in Table 2. It can be seen that MIC is the most potent pulmonary irritant of the substances tested in this bioassay. No  $RD_{50}TC$  is available for toluene diisocyanate, but the value is larger than 1 ppm (13).

**Warning vs. Pulmonary Injury for MIC.** Sensory irritation, as measured by  $RD_{50}$  in mice, is correlated with a burning sensation in the eyes, nose, and throat in humans. Humans subjects would report intolerable irritation at the  $RD_{50}$  level found in mice (9,14). Recently, it has been further confirmed that this animal model accurately predicts sensory irritation in humans (15). On the other hand,  $RD_{50}TC$  is a concentration at which pulmonary injury is likely; thus, the ratio  $RD_{50}TC/RD_{50}$  can be taken to indicate the potential for lung injury/warning from sensory irritation (11). The higher the ratio, the better the warning property and the better the chance that individuals would be warned of the presence of a potentially harmful chemical and would seek to escape from that atmosphere and end their exposure. Such ratios for several industrial chemicals are presented in Table 3.

It can be seen that MIC, along with nitrogen dioxide, chlorine, and hydrogen chloride, have very low  $RD_{50}TC/RD_{50}$  ratios. The concentration capable of inducing lung injury is just slightly above the concentration which would provide a good warning for sensory irritation, and thus, these chemicals must be handled with greater precaution than chemicals with high ratios. The second factor to consider is a chemical's potency as a pulmonary irritant. Although MIC and chlorine have the same ratios, MIC is seven times more potent than chlorine. Nitrogen dioxide has the lowest ratio, but is 180 times less potent than MIC. It would be of interest to test phosgene. This chemical would have a  $RD_{50}TC/RD_{50}$  ratio below 1, but would be a more potent pulmonary irritant than MIC.

**Acute Toxic Hazard of MIC.** In order to determine the inhalational toxic hazard of a chemical, we need to know the potency ( $P$ ) of the chemical, the duration of exposure ( $T$ ), and how much of this chemical ( $C$ ) can be present in the atmosphere if a spill occurs. The worst situation would be a closed room with sufficient amount

Table 2.  $RD_{50}TC$  values found in Swiss-Webster mice for different industrial chemicals.

Chemicals	$RD_{50}TC$ , ppm
Ammonia	1603
Hydrogen chloride	540
Sulfur dioxide	380
Nitrogen dioxide	344
Acrolein	142
Formaldehyde	114
Chlorine	12.4
Methyl isocyanate	1.9
Toluene diisocyanate	> 1*

\* From Sangha and Alarie (13); all other  $RD_{50}TC$  values are from Alarie (11) except for methyl isocyanate.

of a chemical in it to immediately produce a saturated vapor concentration.  $C$  is 457,894 ppm for MIC, based on its vapor pressure of 348 mmHg at 20°C. If we take the  $RD_{50}TC$  (1.9 ppm) as its potency, then the ratio  $C/P$  for MIC is 241,000, which is an extremely high ratio. Therefore, even a short duration of exposure is likely to induce a severe effect. Since we do not have an exact value for  $RD_{50}TC$  for toluene diisocyanate (12), we can assume a value of 4 ppm for  $P$ . In this case,  $C$  would be 26 ppm since the vapor pressure for this chemical is only 0.02 mmHg at 20°C. Thus,  $C/P$  is only 5.3, indicating a much lower toxic hazard than MIC. Duration of exposure to TDI, consequently, is not as critical as in the case of MIC.

**Prediction of Safe Level of Exposure.** An empirical relationship has been found between 0.03  $RD_{50}$  and the Threshold-Limit Values (TLVs) for 41 industrial chemicals (12). TLVs were established by the American Conference of Governmental Industrial Hygienists

Table 3.  $RD_{50}TC/RD_{50}$  ratios for a series of industrial chemicals.

Chemicals	Ratios*
Acrolein	84.5
Formaldehyde	31.0
Ammonia	5.3
Sulfur dioxide	3.2
Hydrogen chloride	1.7
Methyl isocyanate	1.5
Chlorine	1.4
Nitrogen dioxide	1.0

\* Ratios are from Alarie (11) except for methyl isocyanate.

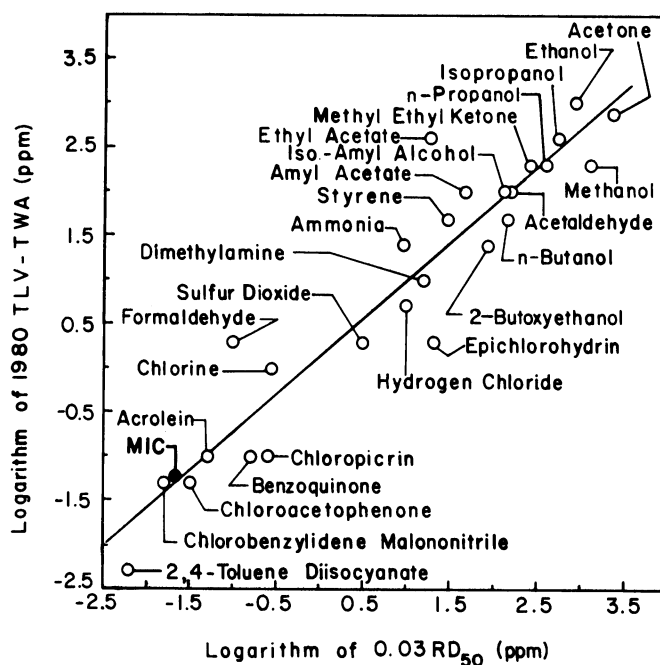

FIGURE 2. Linear least-squares regression analysis, plotting  $\log 0.03 RD_{50}$  as the proposed TLV-TWA versus the log of the 1980 TLV-TWA value for each chemical. From Alarie (25). (Reprinted with permission from Pergamon Press.) The data point for MIC has been added (●).

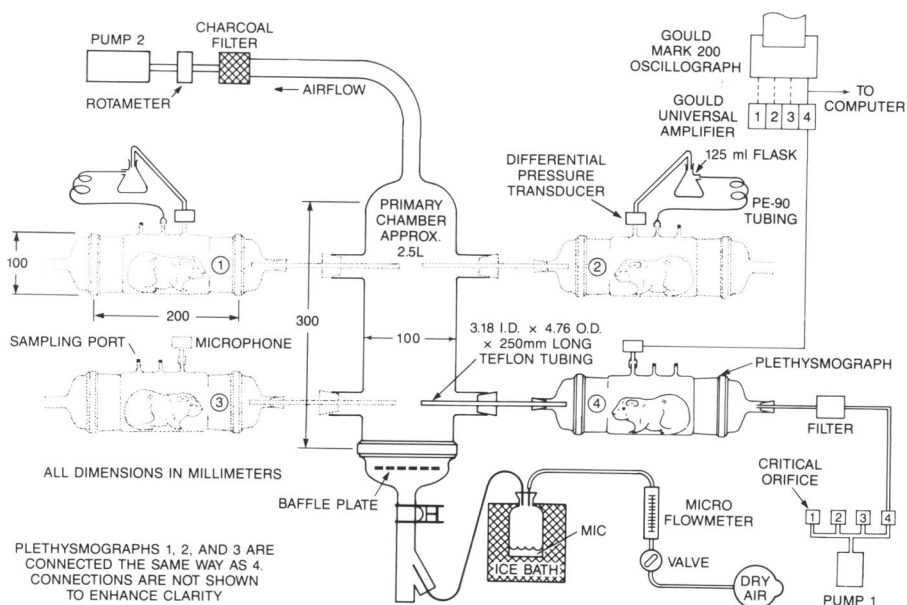

FIGURE 3. System for exposure of guinea pigs to MIC and monitoring respiration. MIC was metered into the primary chamber and the desired concentration was established, then the animal plethysmographs were connected to the primary chamber to initiate exposure. The same system was used for exposure to hydrogen cyanide. Modified from Ellakkani et al. (26). (Reprinted with permission from Academic Press.)

(ACGIH). The relationship is shown for 26 chemicals (of the 41) in Figure 2; the data point for MIC has been added. The TLV for MIC has been set at 0.02 ppm by comparison with other isocyanates because of the paucity of data on MIC. From the  $RD_{50}$  value obtained, a TLV of 0.04 ppm would be predicted for MIC by taking 0.03  $RD_{50}$ . Since we observed some indication that MIC also acts as a pulmonary irritant at levels inducing sensory irritation, 0.01  $RD_{50}TC$  would be a better predictor, as suggested previously (16,17). The  $RD_{50}TC$  would yield a predicted TLV of 0.02 ppm. Interestingly, the ACGIH published a value of 0.02 ppm for MIC in 1967. The criteria for setting this value were mainly based on comparison to TDI.

## Recovery from Pulmonary Irritation

### Methods

**Animals.** Male, English smooth-haired guinea pigs were obtained from Hilltop Lab Animals, (Scottsdale, PA). Animals with body weights between 310 and 350 g were used.

**Exposure Groups.** Groups of eight animals were used at each exposure concentration of MIC from 2 to 37 ppm of MIC, and one group was used as a control. Only the results obtained at 37 ppm are presented here.

**Exposure System.** The exposure system used is shown in Figure 3. Each animal was held in a whole body plethysmograph attached to a primary chamber into which MIC was delivered. The exposure concentration was established by changing the delivery rate of MIC vapor or the airflow of this chamber. Once the

desired concentration was established, each plethysmograph was attached to the primary chamber to initiate the exposure. Each exposure lasted 3 hr. The delivery system for MIC and the analytical procedures were the same as those for exposure of mice (3).

**Evaluation of the Pulmonary Effects and Recovery.** Two types of measurements were performed in an attempt to detect a pulmonary response to MIC. The first measurement consisted of monitoring respiratory frequency, tidal volume, and coughing during exposure to detect any changes from the normal pattern. Secondly, animals were challenged with 10%  $CO_2$  to stimulate ventilation. Normal and abnormal responses to  $CO_2$  have been well characterized (18,19). The  $CO_2$  test enables a rapid assessment of pulmonary performance over time.

**Respiratory Frequency ( $f$ ), Amplitude ( $\Delta P$ ), and Coughing.** A sensitive differential transducer (Galectec, Model 8T-2) or a microphone (Gould, Model 689837.1) was attached to each whole body plethysmograph as shown in Figure 3. With each breath, a pressure change ( $\Delta P$ ) was created in the plethysmograph and detected by the transducer (or microphone). The pressure change was amplified and displayed on an oscillograph. This procedure permitted inspection of respiratory patterns, including apneic periods and coughing. Coughing was recognized by large and sharp pressure fluctuations noted on the oscillograph and correlated with visual inspection of the animals.

**Ventilatory Response to  $CO_2$ .** Challenges with 10%  $CO_2$  were conducted prior to exposure and at various time periods following exposure. The system used was a simplification of a system used previously (19). As

shown in Figure 4, each animal was placed in a holding cylinder and fitted with a head chamber. This permitted measurement of inspiratory and expiratory airflows ( $\dot{V}_I$ ,  $\dot{V}_E$ ) which, when integrated with time, yielded tidal volume,  $VT$ . Respiratory frequency ( $f$ ) was also obtained from this measurement. Also,  $\dot{V}$ - $VT$  loops were obtained from these measurements. First, the ventilatory parameters were measured during air breathing. Then, using a mixture containing 10%  $CO_2$  in 20%  $O_2$ , 70%  $N_2$  or 19%  $O_2$ , 71%  $N_2$  was introduced in the system and the same measurements were taken again once  $VT$  had reached a stable increase. A stable increase was observed well within 4 min.

## Results

The results presented were obtained at an exposure concentration of 37 ppm for 3 hr. All animals were studied immediately after exposure, but at this concentration, six of eight animals died within 48 hr. The two survivors were studied extensively during the following 35 days. Thus, the effect of MIC on these two animals probably represent the worst possible effects, short of death.

**Respiratory Frequency ( $f$ ) and Coughing.** Immediately upon exposure to 37 ppm MIC,  $f$  decreased, and coughing was very frequent, as shown in Figure 5. Coughing was also present following exposure and still present 5 days after exposure in the two survivors.

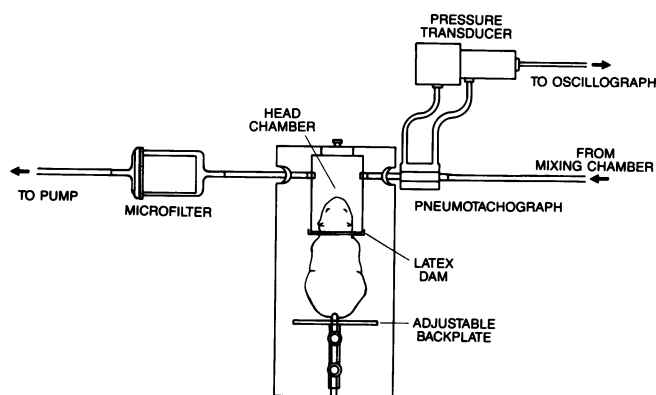

FIGURE 4. Overhead view of system designed to measure  $\dot{V}$ ,  $VT$  (through integration of  $\dot{V}$  with time),  $f$ , and  $\dot{V}$ - $VT$  loops during air breathing and 10%  $CO_2$  challenge. Each animal was fitted with a head chamber positioned inside a cylinder fitted with an adjustable back plate. Air or other mixtures (e.g., 10%  $CO_2$ ) were pulled from a mixing chamber and through the head chamber at 2 L/min. A pneumotachograph was attached to a differential pressure transducer (Statham or Gaeltec) and placed at the inlet of the head chamber. It measured both flow ( $\dot{V}$ ) of air passing through the head chamber and flow associated with inspiration ( $\dot{V}_I$ ) and expiration ( $\dot{V}_E$ ) of the guinea pig. The changes in air flow due to respiration were simply superimposed on the continuous head chamber flow signal. Four chambers, as the one shown here, were attached to one mixing chamber, thus enabling the ventilatory measurements of four guinea pigs to be made simultaneously. The  $\dot{V}$  signal from each animal was displayed on an oscillograph and simultaneously digitized (250 samples/sec) for storage on floppy disc. A computer program integrated  $\dot{V}$  with time to obtain  $VT$ .  $\dot{V}$ ,  $VT$ , and  $\dot{V}$ - $VT$  loops were displayed on a video terminal from which copies were made.

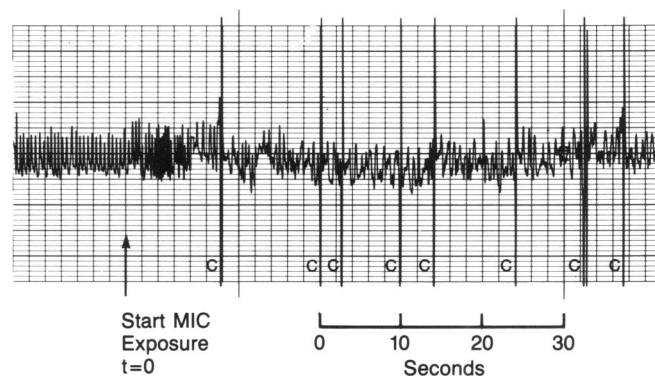

FIGURE 5. Respiratory pattern during exposure to MIC at 37 ppm. Coughing (C) is indicated by the sharp large pressure fluctuations.

**Ventilatory Response to  $CO_2$  and  $\dot{V}$ - $VT$  Loops.** Ventilatory response to  $CO_2$  and  $\dot{V}$ - $VT$  loops were measured in all animals prior to exposure, immediately following exposure, and at various time intervals following exposure for the two survivors, as shown for one survivor in Figures 6 and 7. The breathing patterns were obviously abnormal in all animals following exposure. The abnormalities were most pronounced 2 days after exposure, rather than immediately following exposure, in the survivors. All animals failed to exhibit a normal increase in  $VT$  or  $f$  during  $CO_2$  challenge immediately following exposure (Fig. 7). From days 5 to 14, there was some recovery in the two survivors, but  $\dot{V}$ - $VT$  loops were abnormal, and the response to  $CO_2$  challenge was still much lower than normal, particularly with regard to the expected increase in  $f$  (Fig. 7). From the tracings in Figure 6, it can be seen that the reason for the decrease in  $f$  during air breathing and during  $CO_2$  challenge was due to a lengthening of the duration of expiration ( $TE$ ).

Of interest is the fact that the animals' conditions worsened at day 21, but the animals recovered (although not completely) on day 35. Both animals exhibited body weight increases comparable to controls on day 35.

## Discussion

The results obtained indicate that MIC induced severe airways obstruction and that recovery from the pulmonary effects of MIC is very slow—much slower than recovery following pulmonary irritation induced by sulfuric acid (18), toluene diisocyanate (TDI) (20), or smoke from wood (21). The recovery from MIC is similar to that following exposure to smoke from polyvinyl chloride (22). The results obtained also indicate that at 37 ppm, MIC induced obstruction as defined by Schaper et al. (19). This obstruction can be seen from Figures 6 and 7, in that after  $CO_2$  challenges, there was a failure to increase  $f$  and  $VT$  to the level of normal animals.  $TE$  was longer, and airflow during expiration ( $\dot{V}_E$ ) was greatly reduced after the initial maximum. The same effect was obtained with carbamylcholine, a known

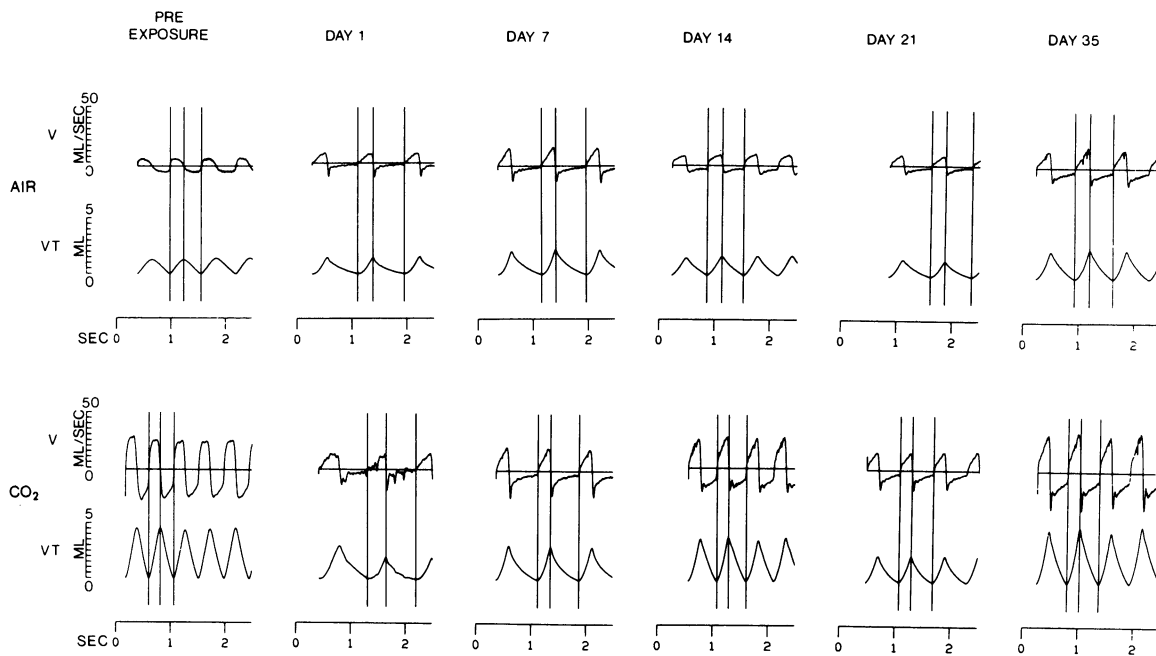

FIGURE 6.  $\dot{V}$  and VT signals recorded in one of two surviving animals prior to and at various time intervals following a 3 hr exposure to MIC at 37 ppm. The same  $\dot{V}$  and VT signals were used to plot  $\dot{V}$ -VT loops, shown in Fig. 7. The horizontal line on the  $\dot{V}$  signal separates inspiration (upward) from expiration (downward). The calibration at the left of each signal is the same for all measurements. Measurements were first taken during air breathing (top of the figure) and then during 10% CO<sub>2</sub> challenge (bottom of figure).

bronchoconstrictor, and thus, the classification of obstruction applies (19).

As reported by Kamat et al. (8), flow-volume curves (or loops) obtained in surviving victims of the Bhopal disaster showed numerous abnormalities. These abnormalities included an inspiratory or expiratory sawtooth pattern, expiratory concavity on the descending limb, and a fluctuating appearance of the expiratory portion. All can easily be observed in Figure 7, which displays the loops from one guinea pig surviving exposure to 37 ppm of MIC. Thus, there appeared to be a good deal of similarity between the animal responses and those of the Bhopal victims. Furthermore, the lengthening of expiration (TE) has been found in subjects with obstructive lung disease, and flow-volume loops of these subjects indicate that flow is abnormal during expiration. A maximum in flow that cannot be maintained is reached early during expiration, and a sharp return toward zero flow is seen after peak flow is reached (23). This same type of loop was obtained in the MIC-exposed guinea pigs. Therefore, it is appropriate to conclude that the primary pulmonary effect of MIC was one of obstruction.

Kamat et al. (8) noted that in some individuals, flow-volume curves indicated a restrictive disability, whereas a mixture of obstruction and restrictive disability was found in others. It is possible that this reaction will also be observed as the two surviving guinea pigs are monitored, since a restriction pattern and mixed patterns can also be detected in guinea pigs using the same technique (19).

It is of interest to compare results from this study with pulmonary function evaluations and histopathological findings reported by other investigators (4). Researchers exposed rats to MIC and found airway narrowing and edema as the early major results following exposure. This correlates well with the obstruction pattern observed in the guinea pigs in this study. Researchers also noted that the epithelial lesions were rapidly repaired, just as we found recovery (although not complete) between day 2 and 14. Finally, residual peribronchial fibrosis and signs of renewed injury and inflammation were reported, which correlates with our findings of a worsening effect between day 14 and 21.

## Cyanidelike Effect

A simple way to investigate whether or not MIC can induce a cyanidelike effect, i.e., inhibition of oxygen utilization at the cellular level, is to measure oxygen consumption using the apparatus described by Haldane (24). There is a possible complicating factor with MIC: due to its irritating effect, minute ventilation, pulmonary diffusion, and distribution of ventilation are compromised. However, this can be taken into account to some extent by measuring the percent O<sub>2</sub> extracted/mL of minute ventilation if O<sub>2</sub> uptake and minute ventilation are measured. Minute ventilation was measured as presented in the preceding section on recovery from pulmonary irritation. A positive control experiment was conducted with hydrogen cyanide.

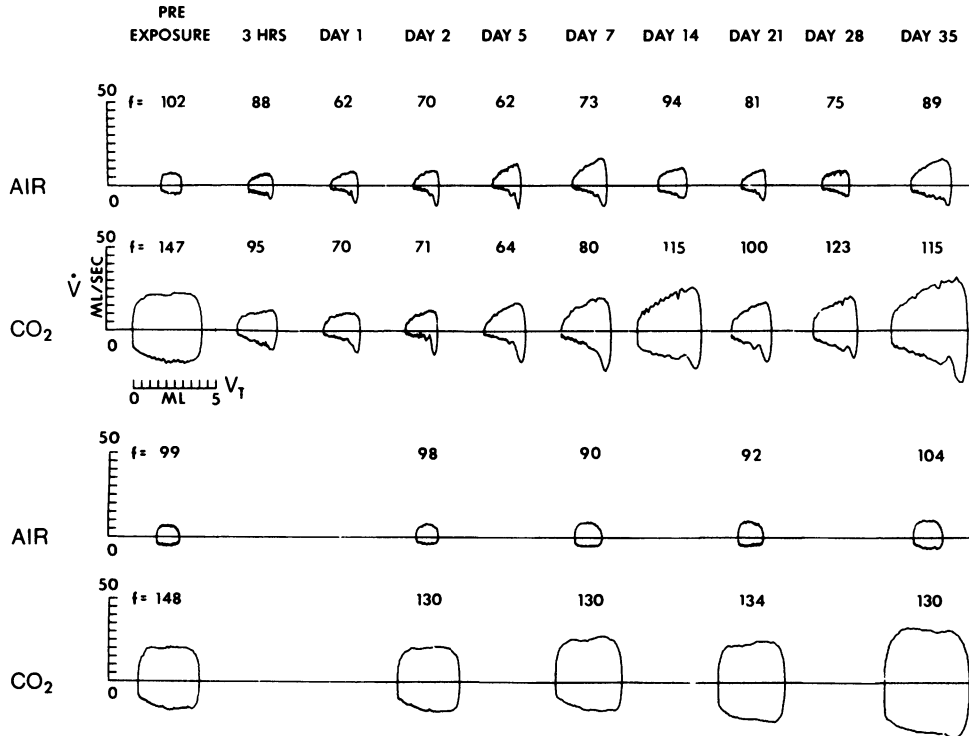

FIGURE 7. Flow-volume ( $\dot{V}$ - $V_T$ ) loops during air and during 10%  $\text{CO}_2$  challenge in one of two surviving animals prior to and at various time intervals following a 3 hr exposure to MIC at 37 ppm (top two tracings) and for one control animal (bottom two tracings). Each  $\dot{V}$ - $V_T$  loop is separated by a horizontal line with inspiration and expiration above and below the line, respectively. The scale for  $\dot{V}$  and  $V_T$  is the same for all the loops. Respiratory frequency ( $f$ ) is given in breaths/min at the top of each loop and represents the average value of 12 breaths, obtained from the tracings shown in Fig. 6. Comparisons between the exposed animal and the control should be made on similar days from pre-exposure since these animals (310–350 g body weight at pre-exposure) are growing, and  $\dot{V}$  as well as  $V_T$ , increase with growth.

Table 4. Oxygen uptake and  $\text{CO}_2$  output in guinea pigs (310–350 g body weight) exposed to methyl isocyanate at 37 ppm for 3 hr.

	Pre-exposure	3 hr <sup>a</sup>	1 day	2 days
Number of animals measured	8	8	5 <sup>b</sup>	2 <sup>b</sup>
$\text{O}_2$ uptake, mL/min	6.1 <sup>c</sup> (12)	6.7 (10)	5.8 (4)	5.8 (9)
$\text{CO}_2$ output, mL/min	7.4 (10)	6.3 (10)	6.1 (7)	5.4 (11)
$V_T$ , mL	1.3 (16)	1.9 (19)	1.4 (45)	1.5 (11)
$f$ , breaths/min	112 (12)	63 (25)	91 (49)	88 (32)
$V_T \cdot f$ mL/min	146 (19)	117 (15)	105 (13)	128 (22)
% of $V_T \cdot f$ extracted as $\text{O}_2$	4.3 (23)	5.7 (12)	5.4 (9)	4.6 (13)

<sup>a</sup> Measurements taken after 3 hr of exposure and at 1 and 2 days postexposure.

<sup>b</sup> Three animals died following exposure prior to measurement on day 1, followed by three more deaths prior to measurement on day 2.

<sup>c</sup> Values are the mean for the number of animals measured with the coefficient of variation given in parentheses. Values for  $\text{O}_2$  and  $\text{CO}_2$  are corrected for standard temperature and pressure, dry (STPD).

## Methods

The apparatus used to measure  $\text{O}_2$  uptake and  $\text{CO}_2$

output is shown in Figure 8. It follows the principles given by Haldane, (24) but uses modern analyzers for  $\text{O}_2$  and  $\text{CO}_2$ . The animals tested were as described in the preceding section. The measurements were obtained prior to exposure and at various time intervals following exposure. The system described in Figure 3 was used for exposure to hydrogen cyanide by delivering this gas with a flowmeter. One group of four animals was exposed to increasing concentrations to induce a recognizable effect of asphyxiation, *i.e.*, animal falling on its side and a respiratory pattern indicating asphyxiation (26). As soon as evidence of asphyxiation was observed in one of four simultaneously exposed animals, the exposure was terminated, and the animal appearing the most affected was immediately transferred to the apparatus for  $\text{O}_2$  uptake measurements. The exposure proceeded as follows: 115 ppm for 30 min, 217 ppm for 15 min, and 340 ppm for less than 2 min. These concentrations were determined from air samples taken from the exposure chamber with a 1 mL gas-tight syringe for injection into a gas chromatograph equipped with a nitrogen detector (27).

## Results

The results for the group exposed to MIC at 37 ppm are presented in Table 4 and are self-explanatory. There

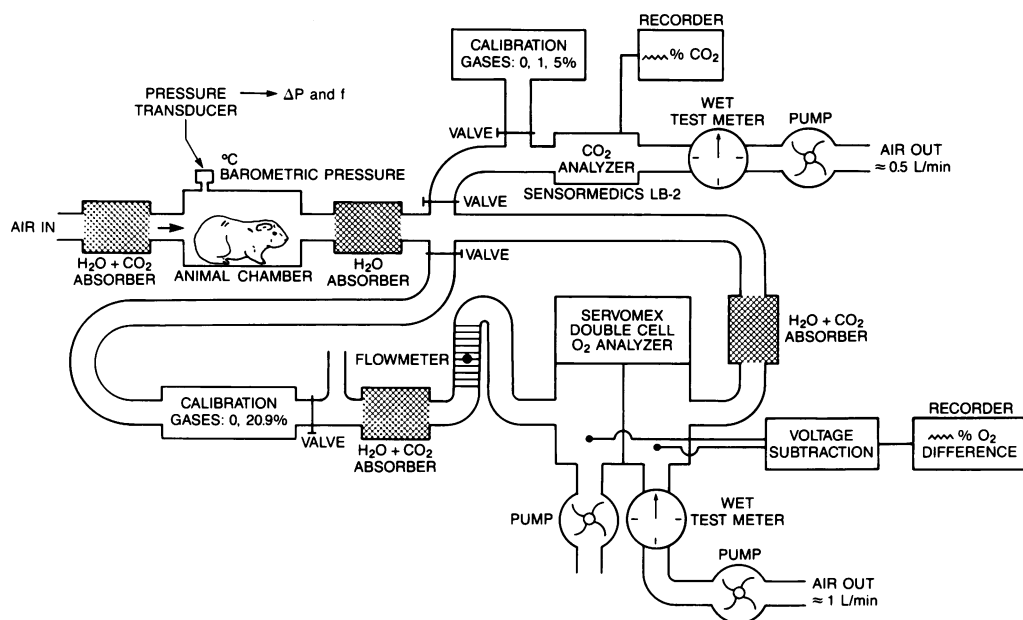

FIGURE 8. Schematic presentation of Haldane's apparatus (24) to measure  $O_2$  uptake and  $CO_2$  output. This is a flow-through apparatus with analyzers monitoring  $O_2$  and  $CO_2$  concentrations. From these concentrations and the volume of air passing through the animal chamber, monitored by wet test meters as shown, the  $O_2$  uptake and  $CO_2$  output in mL/min were calculated and corrected for temperature and barometric pressure, i.e., standard temperature and pressure, dry (STPD).  $O_2$  uptake was obtained by monitoring the difference between inlet and outlet using a double cell  $O_2$  analyzer as shown. A pressure transducer can also be attached to measure the pressure change ( $\Delta P$ ) due to each respiration, which is an indirect method to obtain  $VT$  (18). However, because of the intense airway obstruction caused by MIC, minute ventilation was obtained using the apparatus shown in Fig. 4 after making the  $O_2$  uptake and  $CO_2$  output measurements.

was no evidence of inhibition of oxygen utilization, despite a reduction in minute ventilation. During exposure to cyanide at 115 and 217 ppm, nothing remarkable occurred. Within 30 sec after increasing concentration to 340 ppm, signs of weakness appeared; one guinea pig fell on the side of the exposure chamber and exhibited a respiratory pattern indicating asphyxiation. By the time hydrogen cyanide was turned off and the exposure chamber was clearing, all four animals were severely affected. One animal immediately transferred to the  $O_2$  uptake measurement apparatus showed a level of  $O_2$  uptake 75% below the level obtained prior to exposure. Recovery was monitored, and the  $O_2$  uptake was back to the pre-exposure level with 30 min. The three other animals also showed comparable  $O_2$  uptake levels to their pre-exposure levels when measured 30 min after exposure to hydrogen cyanide. Thus, the depression of  $O_2$  uptake was very pronounced immediately after exposure (measurement made on only one animal), but all animals recovered rapidly.

## Discussion

Although these results do not prove that cyanide was absent during the Bhopal disaster, there is no indication that MIC induced a cyanidelike effect, even at a very high exposure concentration. The possible formation of cyanide during this disaster has also been investigated experimentally with MIC mixed with water and ferric

chloride and reacted at 300°C under pressure, and no evidence of cyanide was found (?).

## Summary

These investigations revealed the high potency of MIC as a sensory and pulmonary irritant in mice and as a severe airway obstructor in guinea pigs; therefore, MIC would be classified as a respiratory irritant (9). Recovery in guinea pigs was complicated by worsening episodes during the recovery period. A possible change may occur, revealing a restrictive type disease following the first recovery phase. The degree of similarity between flow-volume loops obtained in guinea pigs and human victims is encouraging. This increases our confidence in the flow-volume analysis method for evaluating other agents in guinea pigs to predict pulmonary toxicity in humans. A cyanidelike effect of MIC in humans is very unlikely.

This study was supported under Grant 1-R01-ES02747 from the National Institute of Environmental Health Sciences. We thank S. R. Kamat, KEM Hospital, Bombay, India, for sharing with us flow-volume loops obtained in victims recovering from the Bhopal disaster.

## REFERENCES

1. Kimmerle, G, and Eben, A. Zur toxicitat von methylisocyanat und dessen quantitativer Bestimmung in der Luft. Arch. Toxikol. 20: 235-241 (1964).
2. Smyth, H. F., Jr., Carpenter, C. P., Weil, C. S., Pozzani, U. C.,



- Streigel, J. A., and Nycum, J. S. Range-finding toxicity data: List VII. *Am. Ind. Hyg. Assoc. J.* 30: 470-476 (1969).
3. Ferguson, J. S., Schaper, M., Stock, M. F., Weyel, D. A., and Alarie, Y. Sensory and pulmonary irritation with exposure to methyl isocyanate. *Toxicol. Appl. Pharmacol.* 82: 329-335 (1986).
  4. Nemery, B., Dinsdale, D., Sparrow, S., and Ray, D. E. Effects of methyl isocyanate on the respiratory tract of rats. *Br. J. Indust. Med.* 42: 799-805 (1985).
  5. Salmon, A. G., Kerr Muir, M., and Anderson, N. Acute toxicity of methyl isocyanate: a preliminary study of the dose response for eye and other effects. *Br. J. Indust. Med.* 42: 795-798 (1985).
  6. Dave, J. M. The Bhopal methyl isocyanate (MIC) incident: an overview. In: *Proceedings of an International Symposium on Highly Toxic Chemicals: Detection and Protection Methods* (H. B. Schiefer, Ed.), Saskatoon, University of Saskatchewan, Canada, Sept. 1985, pp. 1-39.
  7. Varadarajan, S., Doraiswamy, L. K., Ayyangar, N. R., Iyer, C. S. P., Kahn, A. A., Lahiri, A. K. Muzumdar, K. V., Mashelkar, R. A., Mitra, R. B., Nambiar, O. G. B., Ramachandran, V., Sahasrabudhe, V. D., Sivaram, S., Sriram, M., Thyagarajan, G., and Venkataraman, R. S. Report on scientific studies on the factors related to Bhopal toxic gas leakage. Government of India, 1985, 81 pp.
  8. Kamat, S. R., Mahashur, A. A., Tiwari, A. K. B., Potdar, P. V., Gaur, M., Kolhatkar, V. P., Vaidya, P., Parmar, D., Rupwate, R., Chatterjee, T. S., Jain, K., Kelkar, M. D., and Kinare, S. G. Early observations on pulmonary changes and clinical morbidity due to the isocyanate gas leak at Bhopal. *J. Postgrad. Med.* 31: 63-72 (1985).
  9. Alarie, Y. Sensory irritation by airborne chemicals. *CRC Crit. Rev. Toxicol.* 2: 299-366 (1973).
  10. ASTM. Standard test method for estimating sensory irritancy of airborne chemicals, Designation E981-84. In: *Annual Book of ASTM Standards, Vol 11.04, Pesticides, Resource Recovery; Hazardous Substances and Oil Spill Response; Waste Disposal, Biologic Effects.* American Society for Testing and Materials, Philadelphia, PA, 1984, pp. 569-584.
  11. Alarie, Y. Toxicological evaluation of airborne chemical irritants and allergens using respiratory reflex reactions. In: *Proceedings of the Inhalation Toxicology and Technology Symposium* (B. K. J. Leong, Ed.), Ann Arbor Science Publishers, Ann Arbor, MI, 1981, pp. 207-231.
  12. Alarie, Y., and Luo, J. E. Sensory irritation by airborne chemicals: a basis to establish acceptable levels of exposure. In: *Toxicology of the Nasal Passages* (C. S. Barrow, Ed.), Hemisphere Publishing Co., New York, 1986, pp. 91-100.
  13. Sangha, G. K., and Alarie, Y. Sensory irritation by toluene diisocyanate in single and repeated exposures. *Toxicol. Appl. Pharmacol.* 50: 533-547 (1979).
  14. Kane, L. E., Barrow, C. S., and Alarie, Y. Short-term test to predict acceptable levels of exposure to airborne sensory irritants. *Am. Ind. Hyg. Assoc. J.* 40: 207-229 (1979).
  15. Andersen, I. Effects of airborne substances on nasal function in human volunteers. In: *Toxicology of the Nasal Passages* (C. S. Barrow, Ed.), Hemisphere Publishing Co., New York, 1986, pp. 14-154.
  16. Weyel, D. A., Rodney, B. S., and Alarie, Y. Sensory irritation, pulmonary irritation and acute lethality of a polymeric isocyanate and sensory irritation of 2,6-toluene diisocyanate. *Toxicol. Appl. Pharmacol.* 64: 423-430 (1982).
  17. Weyel, D. A., and Schaffer, R. B. Pulmonary and sensory irritation of diphenylmethane-4,4'-and dicyclohexylmethane-4,4'-diisocyanate. *Toxicol. Appl. Pharmacol.* 77: 427-433 (1985).
  18. Wong, K. L., and Alarie, Y. A method for repeated evaluation of pulmonary performance in unanesthetized, unrestrained guinea pigs and its application to detect effects of sulfuric acid mist. *Toxicol. Appl. Pharmacol.* 63: 72-90 (1982).
  19. Schaper, M., Thompson, R. D., and Alarie, Y. A method to classify airborne chemicals which alter the normal ventilatory response induced by CO<sub>2</sub>. *Toxicol. Appl. Pharmacol.* 79: 332-341 (1985).
  20. Wong, K. L., Karol, M. H., and Alarie, Y. Use of repeated CO<sub>2</sub> challenges to evaluate pulmonary performance of guinea pigs exposed to toluene diisocyanate. *J. Toxicol. Environ. Health* 15: 137-148 (1985).
  21. Wong, K. L., Stock, M. F., Malek, D. E., and Alarie, Y. Evaluation of the pulmonary effects of wood smoke in guinea pigs by repeated CO<sub>2</sub> challenges. *Toxicol. Appl. Pharmacol.* 75: 69-80 (1984).
  22. Wong, K. L., Stock, M. F., and Alarie, Y. Evaluation of the pulmonary toxicity of plasticized polyvinyl chloride thermal decomposition products in guinea pigs by repeated CO<sub>2</sub> challenges. *Toxicol. Appl. Pharmacol.* 70: 236-248 (1983).
  23. Welch, M. H. Ventilatory function of the lungs. In: *Pulmonary Medicine* (C. A. Guenter and M. H. Welch, Eds.), J. B. Lippincott, Co. New York, 1982, p. 128.
  24. Haldane, J. S. A new form of apparatus for measuring the respiratory exchange of animals. *J. Physiol.* 13: 419-430 (1892).
  25. Alarie, Y. A bioassay to evaluate the potency for airborne sensory irritants and predict acceptable levels of exposure in man. *Food Cosmet. Toxicol.* 19: 623-626 (1981).
  26. Ellakkani, M. A., Alarie, Y. C., Weyel, D. A., Mazumdar, S., and Karol, M. H. Pulmonary reactions to inhaled cotton dust: an animal model for byssinosis. *Toxicol. Appl. Pharmacol.* 74: 267-284 (1984).
  27. Alarie, Y. C., and Anderson, R. C. Toxicologic and acute lethal hazard evaluation of thermal decomposition products of synthetic and natural polymers. *Toxicol. Appl. Pharmacol.* 51: 341-362 (1979).