

# Role of Metabolic Activation in the Pathogenesis of Chemically Induced Pulmonary Disease: Mechanism of Action of the Lung-Toxic Furan, 4-Ipomeanol

by Michael R. Boyd\*

Many xenobiotics produce hepatic injury due to their metabolism in the liver to highly reactive electrophilic intermediates which form covalent conjugates with nucleophilic cellular constituents. This presentation describes studies indicating that the production of chemically reactive metabolites by pulmonary metabolism of xenobiotics can also play a fundamental role in the pathogenesis of chemically induced lung disease.

## Introduction

The isolation, characterization, and chemical synthesis of 4-ipomeanol [1-(3-furyl)-4-hydroxypentanone], a toxic furanoterpenoid produced in mold-damaged sweet potatoes, have been described (1-5). The compound is probably the major component of the "lung edema factor" (6) produced in sweet potatoes (*Ipomoea batatas*) infected with the common mold, *Fusarium solani*. The ingestion of mold-damaged sweet potatoes has been implicated for many years in natural outbreaks of poisoning in cattle. Affected animals suffer severe and often fatal respiratory distress.

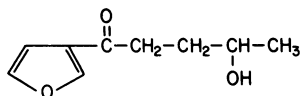

4-IPOMEANOL

Pathological findings are usually restricted to the lungs. Among the typical pulmonary findings are

edema, congestion, and hemorrhage (7). The disease has been given several descriptive names; among these are pulmonary adenomatosis and atypical interstitial pneumonia. The identification of the lung edema factor provides an etiological basis for this peculiar pulmonary disease. In addition, 4-ipomeanol and other toxic components have been detected in minimally blemished sweet potatoes offered for sale at food markets, although the significance of this observation is not known (6).

Chemicals which reproducibly produce an acute, specific pulmonary toxicity by routes of administration other than inhalation are relatively rare and their mechanisms of action are poorly understood. 4-Ipomeanol, therefore, may provide a unique tool with which to probe pathogenetic mechanisms of chemically-induced lung disease. An understanding of the mode of action of this model agent may provide new insight into both normal and abnormal pulmonary physiology as well as into mechanisms of, and factors regulating susceptibility to, pulmonary disease produced in humans by drugs or other chemicals in the environment.

\* Laboratory of Chemical Pharmacology, National Heart and Lung Institute, National Institutes of Health, Bethesda, Maryland 20014.

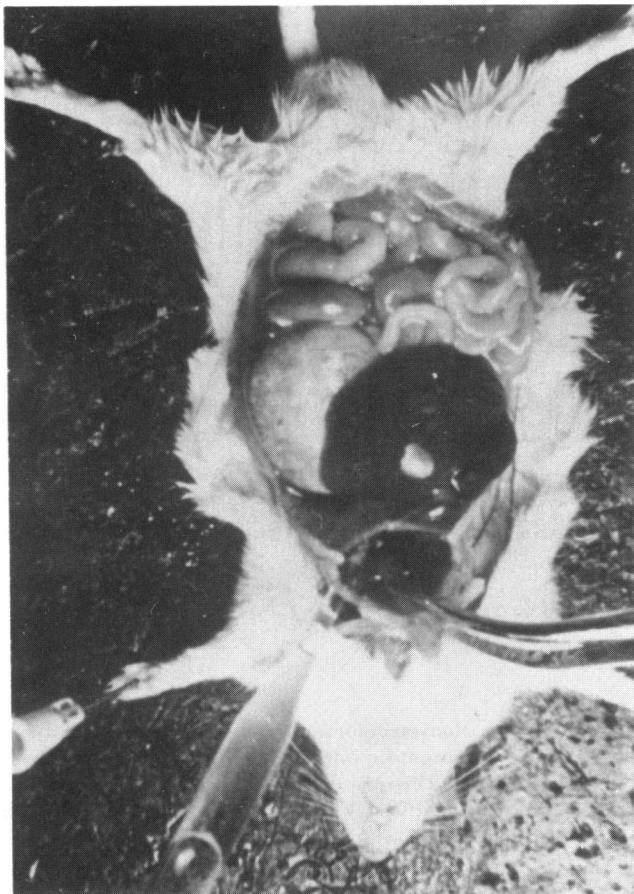
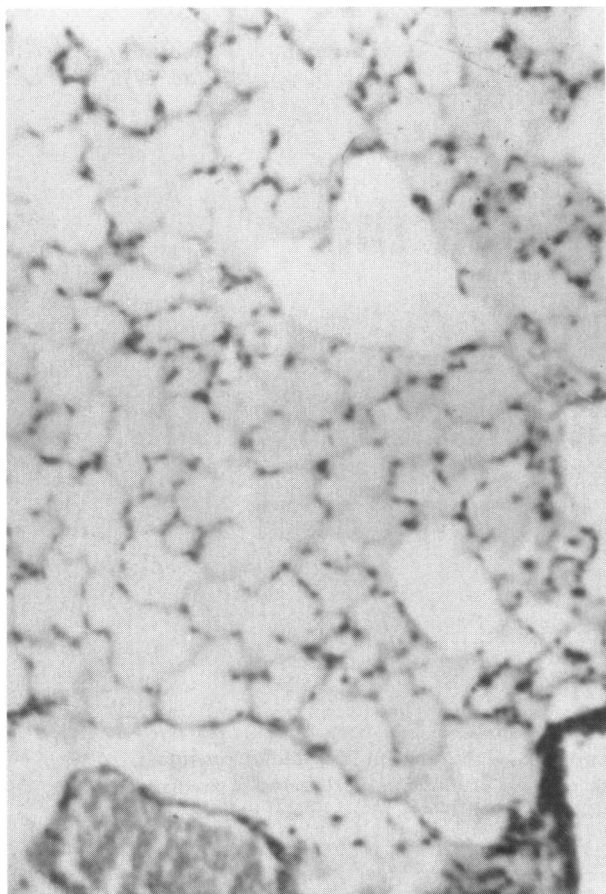

FIGURE 1. Pathological responses to 4-ipomeanol in the mouse 24 hr after a 35 mg/kg dose, IP: (left) massive pleural effusion (fluid in pipet); (right) section showing prominent intra-alveolar edema.

Many xenobiotics are now known to produce liver injury after their conversion in the liver to highly reactive intermediates. The proximate toxins can alkylate adjacent cellular macromolecules and produce tissue damage (8). The realization that the lung can also metabolize some foreign chemicals (9-11) stimulated our interest in the possibility that metabolic activation might likewise be involved in the pathogenesis of certain chemically-induced lung diseases. The purpose of this paper is to briefly review recent work from our laboratory which indicates that 4-ipomeanol toxicity involves metabolic conversion of the compound to a species which alkylates the target tissue. The studies reviewed herein will be described in detail in forthcoming publications.

### Toxicity of 4-Ipomeanol

LD<sub>50</sub> studies were carried out with chemically pure synthetic 4-ipomeanol prepared in our laboratory (3,4). As shown in Table 1, all species

Table 1. Species and sex differences to toxicity of 4-ipomeanol.

Species	Sex	Route of administration	LD <sub>50</sub> (±S.E.), mg/kg
Mouse	M	Oral	38 ± 3
Mouse	M	IV	21 ± 1
Mouse	M	IP	36 ± 4
Mouse	F	IP	28 ± 2
Rat	M	IP	24 ± 2
Rat	F	IP	17 ± 2
Rat	M	IV	18 ± 5
Rabbit	M	IP	30 ± 10
Guinea pig	M	IP	15 ± 5

tested are susceptible to the toxin and the characteristic response is obtained regardless of the route of administration.

In all animal species tested, the lung is the primary target organ. There are, however, some subtle differences in the way the toxicity is

manifested. For example, in the mouse the toxin causes a massive pleural effusion and intraalveolar and perivascular edema (Fig. 1). In the rat (Fig. 2) pleural effusion is usually minimal or absent. However, intraalveolar and perivascular edema are pronounced, and lung damage can be roughly quantitated by lung wet weight/body weight or wet weight/dry weight ratios. In the guinea pig (Fig. 3), the toxin causes a very striking response, characterized by alveolar edema and widespread vascular hemorrhage. In all species, these gross pathological changes are apparent within 6-24 hr after the administration of the toxin.

## Studies on the Mechanism of Action of 4-Ipomeanol

### Distribution and Excretion

The distribution and excretion of radiolabeled 4-ipomeanol were studied in rats after IP administration of  $^{14}\text{C}$ -toxin (12). Within 24 hr, approximately half the administered radioactivity appeared in the urine. Much smaller amounts of

radioactivity were excreted in the feces and expired air. After 96 hr only a few more percent had appeared in the urine, while the total fecal excretion had increased to 15-20% of the administered dose. Excretion of radioactivity into the expired air after 96 hr totaled less than 5%.

According to radiochromatography most of the radioactivity in the urine was due to unmetabolized 4-ipomeanol. Fecal radioactivity was primarily due to unidentified metabolites of the toxin.

The maximal accumulation of radioactivity in the tissues occurred within the first hour, roughly corresponding to the rapid urinary excretion phase. Peak activity in the gut (including contents) occurred later, 2-8 hr after toxin administration. The latter finding may reflect the accumulation of 4-ipomeanol metabolites in the feces in the gut. Carcass and gut contained the greatest total percentage of radioactivity. Liver contained a maximum of about 10% of the total administered radioactivity, while the amounts in lungs, kidneys, and blood reached maxima of about 1-4%. All other tissues contained less than 1% of the administered dose. A maximum of 1-

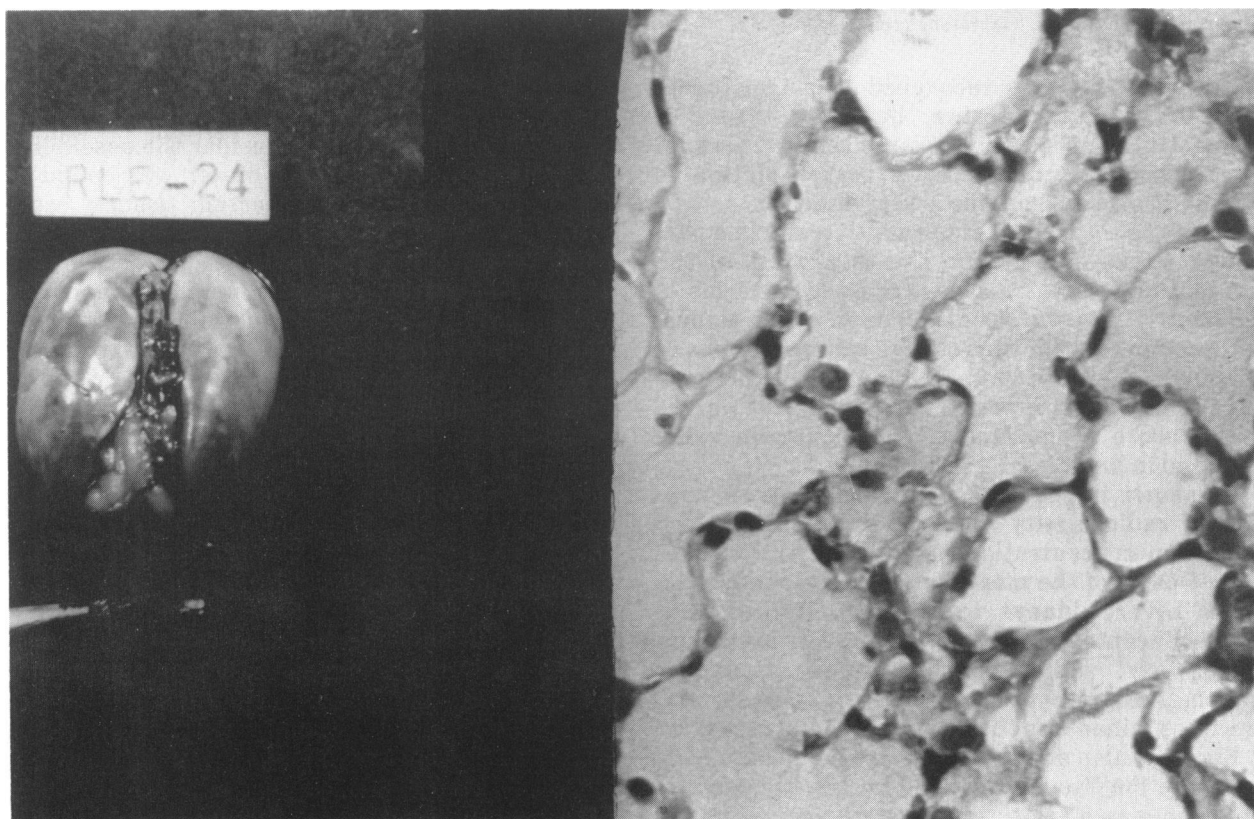

FIGURE 2. Appearance of lungs of a rat receiving a lethal dose (30 mg/kg, IP) of 4-ipomeanol; (left) gross; (right) microscopic.

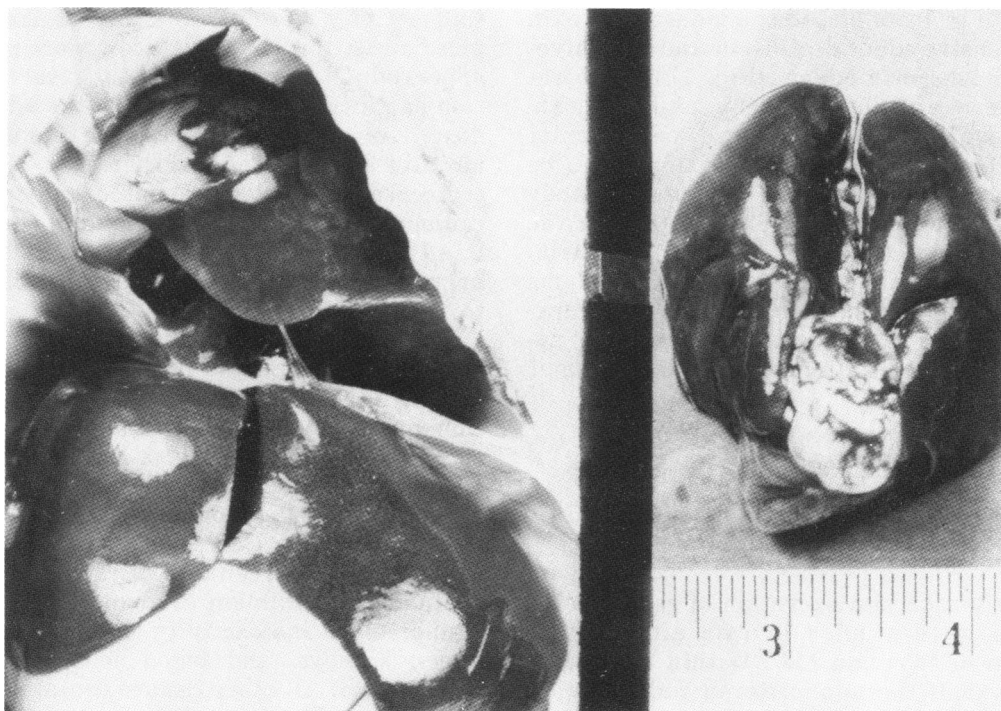

FIGURE 3. Striking pulmonary congestion and hemorrhage in guinea pig given a lethal dose (30 mg/kg, IP) of 4-ipomeanol: (left) lungs *in situ* in thorax; (right) lungs removed *in toto*.

2% of the dose was recovered from peritoneal fluid 0.5 hr after dosing, but only traces of radioactivity were found at later times. This suggests that the administered toxin solution is rapidly absorbed from the site of injection.

Since the total content of radioactivity in a particular tissue depends on the total mass of the tissue, the data were also expressed in terms of radioactivity per gram of tissue in order to permit a comparison of the relative concentrations of 4-ipomeanol and/or its metabolite(s) in the various tissues. Specific activities (dpm/g wet weight tissue) were normalized to the maximum value obtained in lung.

As shown in Figure 4, the greatest concentration of radioactivity occurred in the lung. The maximum concentration in gut and its contents was 85-90% of the maximum level reached in the lungs. Liver, kidneys, and blood contained maximum concentrations of 60-80% of the maximum lung levels, while all other tissues, including spleen, heart, thymus, adrenals, pancreas, and brain contained less than 25% of the lung levels.

Figure 4 also shows that after the peak, which occurs in the tissues after 1-2 hr, the radioactivity declines to a relatively constant concentration representing residual activity. The residual ac-

tivity is greatest in lung and persists at least several days after the injection of 4-ipomeanol. This observation led us to consider the possibility that the toxin, or its metabolite(s), was bound or otherwise sequestered by certain tissues, especially lung.

Other studies have shown that 70-90% of the residual activity remaining in lung, liver, and kidneys after 24 hr is tightly bound to tissue macromolecules. Extensive organic solvent extraction of homogenates of these tissues fails to remove most of the residual activity, suggesting the binding may be covalent. Table 2 shows a comparison of total radioactivity and nonextractable or bound radioactivity in all the various tissues 24 hr after toxin administration. The data are expressed as nanomoles of toxin bound per gram (wet weight) of tissue. The amount of bound activity in lung is markedly greater than in any other tissue.

When the bound radioactivity, shown in Table 2, was measured and expressed in terms of protein-bound toxin, the markedly preferential pulmonary binding was again demonstrated (13). It should be emphasized, of course, that irreversible binding to protein does not imply that protein is necessarily the "target substance;" it is simply

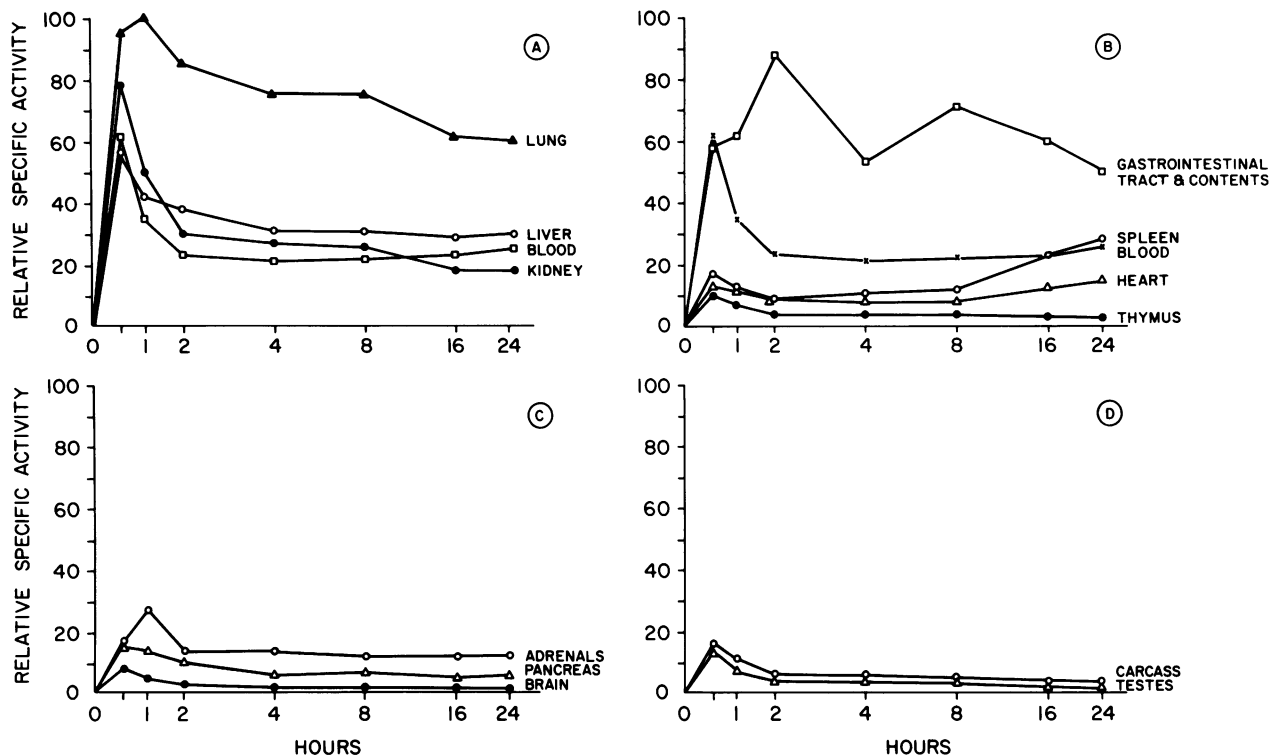

FIGURE 4. Relative concentrations of radioactivity in tissues of the rat after IP administration of 10 mg/kg of 4-ipomeanol-3,5-<sup>14</sup>C.

the fraction which provides the greatest recovery of covalently bound radioactivity. It therefore serves as a way of measuring, experimentally, the presence, or formation, of a chemical species sufficiently reactive to alkylate tissue macromolecules.

The time courses of covalent binding, pulmonary edemagenesis, and lethality have been determined in the rat after administration of <sup>14</sup>C-4-ipomeanol (14). After a toxic dose was given IP, the maximal level of covalently bound compound was attained by 80 min. After intravenous administration, covalent binding peaked in 40 min. It therefore appears not only that the toxin is rapidly absorbed from the peritoneal cavity, but also that covalent binding of toxin occurs rapidly after absorption.

On the other hand, both the pulmonary damage and the lethality occur after the toxin is covalently bound. This of course would be expected, if covalent binding represents an initial event in the toxic mechanism. Lung fluid accumulation (wet weight/dry weight ratios) peaked 16-24 hr after toxin was given IP. Interestingly, this was the time also at which deaths began to occur, sug-

Table 2. Comparison of total concentration of radioactivity with concentration of bound radioactivity in various tissues of the rat 24 hr after administration of 4-ipomeanol-3,5-<sup>14</sup>C.

Tissue	Total radio-activity (± S.E.), nmole toxin/g wet weight tissue	Bound radio-activity (± S.E.), nmole toxin/g wet weight tissue
Lung	134 ± 5	121 ± 5
Liver	67 ± 9	47 ± 12
Kidney	41 ± 2	30 ± 6
Ileum	112 ± 19	6 ± 2
Heart	33 ± 21	1 ± 1
Blood	58 ± 8	2 ± 1
Spleen	64 ± 12	2 ± 1
Adrenals	28 ± 4	1 ± 1
Pancreas	12 ± 3	0.5 ± 0.5
Thymus	8 ± 1	0.3 ± 0.5
Testes	6 ± 1	0.1 ± 0.3
Muscle	11 ± 1	0.1 ± 0.1
Brain	5 ± 1	0.05 ± 0.01

\* Dose of 4-ipomeanol-3,5-<sup>14</sup>C, 10 mg/kg (0.06 mmole/kg).

gesting that lung damage was the cause of death. Animals living longer than 40 hr usually survived.

On the basis of these experiments, covalent binding subsequently was measured routinely at 4 or 8 hr, and the pulmonary wet weight/dry weight ratios were determined at 24 hr after injection of the toxin. At these times the respective parameters had reached their maximal levels and remained relatively constant thereafter.

The dose dependence of covalent binding, pulmonary edemagenesis, and lethality have also been examined (13,14). Although the amount of covalent binding of toxin to lung increased relatively smoothly over the range of doses tested, a pronounced "threshold" effect was observed in the rate of change of the pulmonary wet weight/dry weight ratios. Doses in the range of 2-10 mg/kg produced a slight increase in lung fluid, while doses above 10-15 mg/kg produced a striking increase in the lung fluid accumulation. Deaths also began to occur in the animals with these doses, suggesting again that the lung lesions were the primary cause of death. The "threshold effect" for the increase in lung fluid may be due to a saturation of normal pulmonary mechanisms for handling excess fluid, such as elimination by the lymphatics (15).

#### Studies of Lung and Liver Microsomal Enzymes Which Catalyze Covalent Binding of 4-Ipomeanol

When <sup>14</sup>C-4-ipomeanol was incubated with various subcellular fractions of lung and liver homogenates (in the presence of NADPH), radioactivity became covalently bound predominantly to the microsomal fractions (13,14). The maximal rate of covalent binding of toxin occurred only in the presence of NADPH and oxygen. Binding was strongly inhibited in the presence of a carbon monoxide-enriched atmosphere or by addition of cytochrome c but was not inhibited by addition of cyanide. No binding occurred when heat-denatured microsomes were used, or when the incubation was at 1-2°C. These experiments indicate that, without prior metabolism, 4-ipomeanol is not sufficiently reactive to alkylate tissue components. The covalently bound radioactivity from <sup>14</sup>C-4-ipomeanol, therefore, must represent the formation of a chemically reactive metabolite. The lung and liver microsomal enzyme systems which activate the toxin have the classic characteristics of cytochrome P-450-dependent mixed-function oxidases (MFO).

#### Role of Metabolism and Covalent Binding for Toxicity of 4-Ipomeanol *In Vivo*

Several important questions were apparent at this point. First, does covalent binding of 4-

ipomeanol *in vivo* represent the formation of a chemically reactive metabolite *in vivo*? Second, is the formation of this metabolite responsible for the production of the toxic lesions? And third, given the finding that activating enzymes are present in both lung and liver, what is the source of the metabolite that covalently binds and damages the target tissue?

We approached these questions by examining the effects of various inhibitors and inducers of MFO on the metabolism, covalent binding, and toxicity of 4-ipomeanol (13,14). It should be emphasized that with both inhibitors and inducers it is difficult to predict *a priori* their actual effect on a given toxicity *in vivo*, since they may affect both toxifying as well as detoxifying pathways (16). The situation is especially complex when more than one tissue can serve as a site for both toxication and detoxication, and when each tissue may respond differently to a given inducer or inhibitor. Whatever effect a particular pretreatment produces, however, the correlation between the severity of the toxicity and the degree of covalent binding of the toxin to the target tissue should be maintained if the two phenomena indeed are related.

Pretreatments with pyrazole, piperonyl butoxide, and cobaltous chloride all markedly reduced both the *in vivo* covalent binding and the toxicity of 4-ipomeanol. Although both lung and liver binding were inhibited, lung binding still predominated; lung remained the target organ when larger doses of toxin were given to the pretreated animals. *In vitro* studies likewise confirmed the inhibitory effects of these compounds on microsomal activation of the toxin.  $\beta$ -Diethylaminoethyl-diphenylpropyl acetate (SKF 525-A) inhibited the *in vitro* metabolism and covalent binding, but had no significant effect on the covalent binding or toxicity of 4-ipomeanol *in vivo*. It is likely, therefore, that SKF 525-A inhibits detoxifying metabolic pathways *in vivo* as well as toxifying ones.

These experiments demonstrated an excellent correlation between the degree of toxicity and the amount of covalent binding of toxin to the lung. Furthermore, the only effects of these pretreatments that could satisfactorily account for these findings were their effects of MFO activity. It therefore appears that 4-ipomeanol toxicity is due to the formation of a chemically reactive metabolite *in vivo* which can alkylate tissue.

Two types of MFO inducers, 3-methylcholanthrene (MC) and phenobarbital (PB), were also examined for their effects on covalent binding



and toxicity of 4-ipomeanol (17). A very striking phenomenon was seen with MC pretreatment. In this group of animals, overall toxicity was decreased, but the relative proportion of covalent binding of toxin to liver was markedly increased, whereas it was decreased in the lung. Interestingly, these alterations were associated with the appearance of widespread centrilobular hepatic necrosis in MC-treated rats given toxic doses of 4-ipomeanol. In contrast, pulmonary damage was minimal or absent in these animals.

*In vitro* covalent binding of <sup>14</sup>C-4-ipomeanol was increased in liver microsomes from MC-pretreated rats, but binding to lung microsomes was unchanged. This suggests that the increase in hepatic toxicity of 4-ipomeanol in MC-treated rats is due to an increased hepatic metabolism of the compound to a chemically reactive species. The reduction in lung binding and toxicity in these animals appears to be due to an increased hepatic clearance and shortened biological half-life of the toxin.

PB pretreatment also increased the maximal rate of covalent binding of toxin to liver microsomes *in vitro*, but no change occurred in binding to lung microsomes *in vitro*. These findings indicate that 4-ipomeanol can be metabolized by forms of cytochrome P-450 induced either by PB or by MC. However, PB treatment did not alter the target organ for covalent binding and toxicity of 4-ipomeanol *in vivo*, although it did significantly increase the LD<sub>50</sub> value. Covalent binding of toxin was reduced *in vivo* in both lung and liver in PB-treated animals compared to controls. PB induction probably affects predominant detoxication pathways *in vivo*.

An important conclusion can be drawn from the experiments in MC-pretreated rats. The toxic metabolite of 4-ipomeanol is so reactive that little, if any, of it escapes the organ in which it is formed. It therefore appears that in normal animals the specific lung toxicity produced by 4-ipomeanol results primarily from pulmonary metabolism of the agent; the liver is not a significant source of the reactive metabolite that binds to and damages the lungs. In MC-pretreated animals, liver necrosis results from metabolic activation of 4-ipomeanol by hepatic enzymes.

#### Nature of the Chemically Reactive Metabolite of 4-Ipomeanol: Structural Requirements for 4-Ipomeanol Toxicity

Studies, both *in vitro* and *in vivo*, indicate that the reactive metabolite formed by MFO-catalyzed metabolism of 4-ipomeanol is a highly elec-

trophilic species (13,14). Addition of the nucleophilic tripeptide, glutathione (GSH), or "soluble fraction" (which contains GSH and GSH-transferases), markedly inhibited covalent binding of 4-ipomeanol *in vitro*, presumably by acting as an alternate nucleophile. Depletion of endogenous GSH, by diethyl maleate pretreatment, significantly increased toxicity and covalent binding of 4-ipomeanol *in vivo*; this indicates that a reactive electrophile is also produced *in vivo* from metabolism of 4-ipomeanol and causes the tissue lesions. As a result of these preliminary studies, we have undertaken further investigations to evaluate the possibility that endogenous GSH may have a general role as a modulator of pulmonary toxicities produced by many potentially lung-toxic agents, including 4-ipomeanol. GSH is known to play an important role in the detoxication of several hepatotoxins (8).

Analogues of 4-ipomeanol, in which the furan moiety was replaced by a phenyl or a methyl substituent, were not metabolized to toxic electrophiles *in vivo* or *in vitro* (14). Thus, the furan component of 4-ipomeanol clearly is essential for toxicity and covalent binding of the molecule. Recent data from other laboratories support the conclusion that furans are potentially reactive materials *in vivo*. Swenson et al. (18) have demonstrated that microsomal enzymes convert the dihydrofuran moiety of aflatoxin B<sub>1</sub> to a reactive intermediate, probably an epoxide, and postulated that this metabolite may be the proximate hepatocarcinogen for aflatoxin. Mitchell et al. (19) have shown that a series of furano compounds, including furan itself and the diuretic drug furosemide, produced hepatic and renal necrosis in animals after activation of the furan ring to reactive metabolites, presumably epoxides. From our data, a reasonable candidate for an electrophilic reactant is also a furan epoxide formed from MFO-catalyzed metabolism of 4-ipomeanol (Fig. 5). The simplicity of the 4-ipomeanol molecule indeed greatly limits other possibilities.

#### Development of Tolerance to 4-Ipomeanol Toxicity

Tolerance to normally lethal doses of 4-ipomeanol can be produced in rats by prior administration of small, nonlethal, doses of the toxin itself (20).

This effect may result, at least in part, from a decrease in pulmonary MFO activity which is produced by 4-ipomeanol pretreatment (21). Presumably, the amount of reactive metabolite

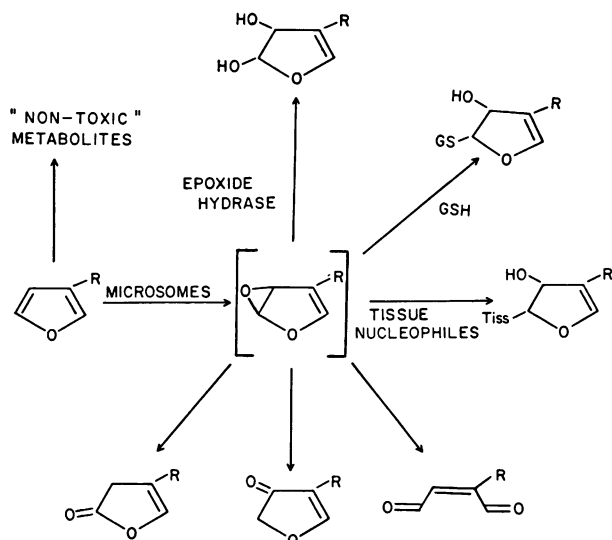

FIGURE 5. Possible pathways for toxication and detoxication of 4-ipomeanol.

formed in the lung from the small pretreatment dose is sufficient to destroy a portion of the enzyme system that formed it without destroying the cells. Therefore, on subsequent challenge with large doses of toxin, there is insufficient enzyme activity to form concentrations of the alkylating metabolite required to produce pathological changes usually seen at these doses. A mechanism of this nature has been proposed by other investigators to account for the marked tolerance to the liver toxicity of carbon tetrachloride, produced by prior treatment with small, nonlethal doses of that hepatotoxic agent (22).

A decrease in hepatic metabolism and covalent binding of 4-ipomeanol is also seen in the 4-ipomeanol-pretreated rats. However, the *in vivo* covalent binding, although decreased in both liver and lung, still is much higher in lung at all doses tested. It is not surprising, therefore, that sufficiently large doses of 4-ipomeanol will still produce the usual selective pulmonary toxicity in the "tolerant" rats.

Alterations in other biochemical parameters may also play a role in the development of tolerance to 4-ipomeanol. For example, in addition to the demonstrated decrease in enzymatic activity for metabolic activation of 4-ipomeanol, it is possible that tolerance could also be caused by increased rates of detoxication of the reactive metabolite. Our present studies have indicated that no microsomal pathways for detoxication are induced by 4-ipomeanol pretreatment in liver or lung. Activities of nonmicrosomal pathways may be important, however. For example, an increase

in GSH availability, and/or in activities of GSH transferases, may allow more effective detoxication of an electrophilic metabolite of 4-ipomeanol. In this regard, it is interesting to note that chronic exposure of lungs to pulmonary irritants, such as ozone, stimulates lung glucose-6-phosphate dehydrogenase activity (23). The increased formation of NADPH that then occurs may in turn increase the availability of alternate nucleophilic sulfhydryls by reduction of disulfide groups (e.g., oxidized GSH to reduced GSH). Further studies, therefore, are underway to determine whether chronic pretreatment with 4-ipomeanol affects GSH availability.

A cellular adaptation phenomenon may also contribute to tolerance development to 4-ipomeanol. Preliminary observations (24) indicate that type II pulmonary alveolar cells are substantially increased in number and size after 4-ipomeanol pretreatment. Proliferation of these cells is a well-documented response of lung tissue to toxic injury (25). Furthermore, Cross (26) recently pointed out that proliferation of these cells not only serves to repair chemically damaged pulmonary tissue, but also may play a key role in augmenting the biochemical defense mechanisms of lung tissue against a variety of types of toxic damage.

Metabolic activation, occurring in the lung, may be an important mechanism underlying the production of lung diseases resulting from exposure to a variety of xenobiotics. Therefore, mechanisms of tolerance induction elucidated for 4-ipomeanol may also be applicable to the well-recognized, but poorly understood, tolerance and cross-tolerance phenomena produced by a variety of lung-toxic chemicals and gases (27).

#### Pathways for Toxication and Detoxication of 4-*Ipomeanol*

Figure 5 shows our present working hypothesis of the important pathways for the toxication and detoxication of 4-ipomeanol. Relative activities of the various pathways shown, in both liver and lung, may modulate susceptibility to the toxin, and may also determine the target organ. In addition, 4-ipomeanol may be metabolized by pathways not involving a reactive intermediate. For example, the side-chain hydroxyl may be a site for conjugation with glucuronic acid; the more readily excretable glucuronide may then appear in feces and/or urine. On the other hand, oxidation by microsomal enzymes probably produces a highly reactive furan epoxide which can further react by a variety of pathways. A 2,3-epoxide is



shown in Figure 5, but a 2,5-epoxide must also be considered a possibility. In either case, it may react with adjacent nucleophilic sites on tissues, or with mobile nucleophiles like GSH. Alternatively, it may rearrange nonenzymatically. One possible rearrangement product is the corresponding dialdehyde, a species which would also be highly reactive and therefore also should be considered a candidate for the proximate toxic metabolite. An intermediate epoxide also may be further metabolized by enzymes such as epoxide hydratases. Moreover, some investigators have found that levels of epoxide hydratase activity in lung are much lower than in liver (28,29). Thus, a relative deficiency of this potential detoxication pathway in lung could play a significant role in the pulmonary specificity of 4-ipomeanol. The possible participation and interplay of all the above reactions in 4-ipomeanol activation and toxicity is under active investigation.

Whereas the liver is composed of a relatively homogenous cell population, the lung is composed of many different cell types. Therefore, an important approach to the mechanism of pulmonary injury produced by a reactive metabolite of 4-ipomeanol will be to determine particular cell type(s) which may be affected. *A priori*, it seems that those cells capable of metabolizing 4-ipomeanol to a reactive species would be most susceptible to its toxic actions. This seems especially likely since the toxic metabolite is very reactive and probably interacts with cellular nucleophiles close to its site of formation. Autoradiographic studies, currently in progress, may permit the identification of cell types to which the toxin is binding. It will then be essential to obtain morphological correlates of covalent binding and cellular alterations. Another important and complementary approach will be the isolation of specific cell populations from lung and the examination of their ability to metabolize 4-ipomeanol to a reactive electrophile. This approach is unfortunately limited at present, since isolation of well defined cell populations has been technically difficult. However, new and useful methods are rapidly becoming available (30).

## Discussion and Perspective

To conclude this presentation, three important points should be emphasized regarding the relevance of the studies with 4-ipomeanol to a general consideration of target organ toxicity. First, it is clear that lung disease can result from the production and interaction of chemically reactive

metabolites formed *in vivo* after administration of a parent toxin by either parenteral or enteral routes. Second, the studies with 4-ipomeanol indicate that lung metabolism *per se* can play a primary role in the production of the proximate toxic metabolites. Third, when a potential toxin can be metabolized in more than one tissue, the target organ for toxicity is dependent upon relative rates of toxication and detoxication pathways available in all the tissues.

Figure 6 is an attempt to illustrate that the target organ of a metabolically activated toxin may be determined by an extraordinarily complex set of pharmacokinetic interactions. Only two potential sites for metabolism of the toxin, liver and lung, are represented.

The parent drug may be delivered to the lung or liver after absorption from parenteral or enteral routes. Absorption of some inhaled compounds directly into the lung parenchyma may also occur. The parent drug may be metabolized and removed from the body by pathways which do not involve formation of chemically reactive intermediates. Good examples of these pathways are the glucuronidation and sulfation of some drugs to form more polar and more readily excretable derivatives. Such pathways are known to be present in both liver and lung (31). Alternatively, a chemically stable parent drug may be metabolized to a chemically reactive intermediate which can produce tissue damage.

Metabolism of certain compounds by the liver is known to produce a variety of types of reactive species. The studies described herein, as well as in other recent reports (32,33), indicate that lung metabolism by both oxidative and reductive pathways can convert certain xenobiotics to several different kinds of chemically reactive species. Also, epoxide intermediates can apparently be formed by pulmonary metabolism of some carcinogens (34) as well as from bromobenzene (35), a compound that produces bronchiolar necrosis in rats. It is likely that many other kinds of chemically reactive metabolites can be produced by lung metabolism of xenobiotics.

Just as the relative rates of disposition of the parent drug along toxifying and detoxifying metabolic pathways can affect the level of reactive intermediate formed, the concentration of the reactant is also affected by its own rate of detoxication. For example, epoxide intermediates may be detoxified by one or more of the several routes discussed earlier. Reactive intermediates other than epoxides likewise may have one or more routes available for detoxication.

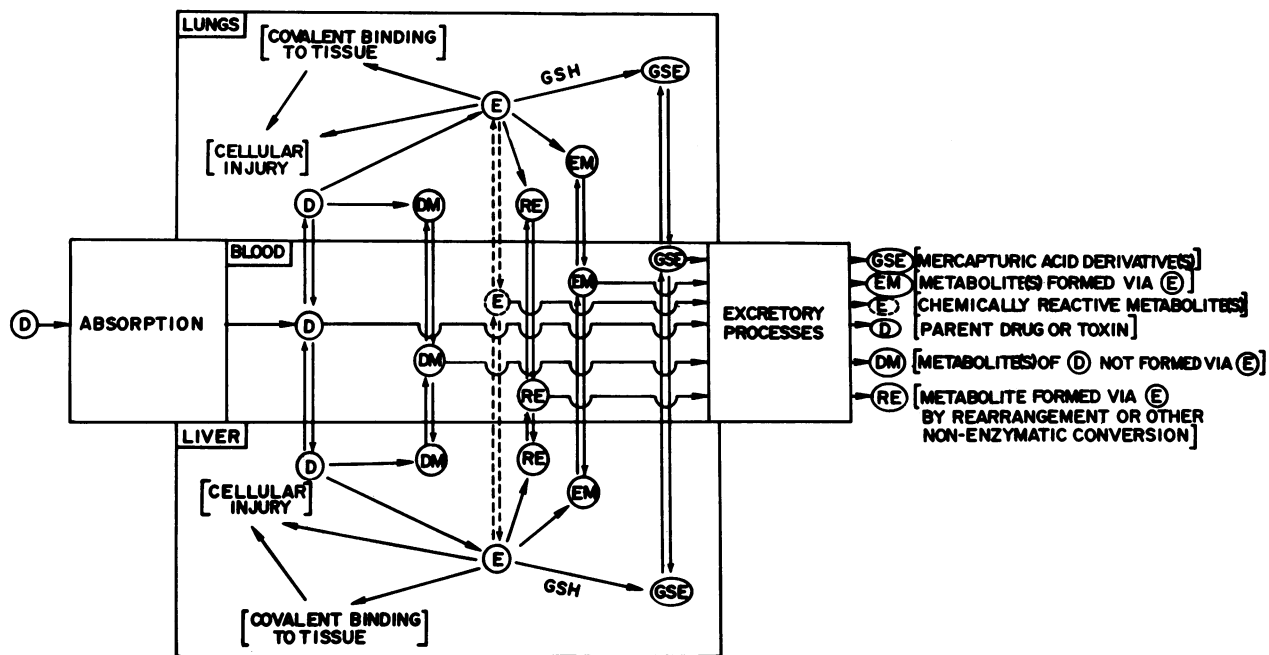

FIGURE 6. Schematic representation of some pharmacokinetic factors that may modulate chemically induced lung disease.

Assuming a reactive metabolite can be formed either at hepatic or extrahepatic sites, or at both sites, with which tissues will it interact to produce pathological changes? Some toxic intermediates are so reactive that they do not escape the organ in which they are formed. The alkylating metabolite formed from 4-ipomeanol appears to be an example. Other proximate toxic metabolites may be sufficiently stable to enter the circulation and subsequently react with tissues different than their site of formation. For example, bromobenzene produces both liver and lung lesions in rats (35); the compound can be metabolized to a chemically reactive species by enzymes present in both liver and lung. However, in this case the toxic metabolite appears to be sufficiently stable to escape the liver (35). Thus, it has not been possible to determine the primary source of the bromobenzene metabolite that covalently binds and damages the lung. It should be re-emphasized, however, that even when a toxin can be metabolically activated at extrahepatic sites such as lung, metabolism in the liver may still play a critical role in determining the target organ for toxicity *in vivo*. This is clearly illustrated by the previously described alteration of target organ for 4-ipomeanol toxicity, produced by MC-pretreatment. In such cases, the much greater mass of metabolically active tissue provided by the liver may provide a level of hepatic

clearance of the toxin such that the delivery of unmetabolized toxin to potential extrahepatic sites for metabolic activation is significantly reduced. This reduction may likewise prevent the appearance of toxic lesions in the extrahepatic tissue.

Lung disease also apparently can result from the formation of reactive metabolites exclusively in the liver. For example, certain toxic pyrrolizidine alkaloids produce lesions in both liver and lung. Mattocks (36) has reviewed work showing that the liver, but not the lung, can convert these alkaloids to reactive pyrrole derivatives which alkylate both liver and lung. Experimentally, these toxic pyrrolic derivatives produce "specific" pulmonary lesions only if given intravenously, into the afferent circulation of the lungs. Although pyrroles can apparently alkylate tissue macromolecules directly, it is interesting to speculate that metabolic activation may also contribute to the covalent binding of pyrroles; pyrroles are nitrogen analogs of furans, and it is clear that furans can be activated by both hepatic and pulmonary metabolism.

Whereas electrophilic metabolites have been clearly implicated in a variety of toxicities, the precise mechanisms whereby they produce tissue lesions are poorly understood. It is probable, however, that covalent binding of toxicants to tissue macromolecules is a primary component in

the mechanism of tissue injury produced by some agents. The tissue lesions may result from a combination of many biochemical and structural alterations produced by nonspecific alkylation of cellular macromolecules. In other instances, although covalent binding serves experimentally as an index of formation of a reactive species, the basic pathogenic process may not have a covalent interaction of toxin and tissue as a primary component. For example, the trichloromethyl radical ( $\cdot\text{CCl}_3$ ) formed *in vivo* by reductive cleavage of carbon tetrachloride covalently binds to liver tissue. However, the hepatic necrosis produced by  $\text{CCl}_4$  probably results from a chain-type peroxidation of hepatic lipids initiated by the electrophilic metabolite (37). Toxins such as 4-ipomeanol may be of considerable value in studies of the molecular pathology of lung damage caused by chemicals. They may offer unique tools with which to probe biochemical and morphological correlates of drug-induced lung disease.

As a final comment, many of the potential pathways for toxication and detoxication of xenobiotics in the lung have not been adequately explored. Furthermore, most of the complex interactions of hepatic and pulmonary metabolism, some of which are schematically represented in Figure 6, need much further characterization. The precedents set by the present studies would seem to justify the speculation that metabolic activation may be an important mechanism underlying the pathogenesis of lung disease resulting from exposure to a variety of xenobiotics by both parenteral and enteral routes, as well as by inhalation. Hopefully, therefore, increased emphasis will be directed to these important areas of investigation.

Most of the experimental work described in the present paper was done in the Departments of Biochemistry and Pharmacology, Vanderbilt University, Nashville, Tennessee, and was supported primarily by a Center in Environmental Toxicology Grant ES 00267. Figure 1 was reproduced from Wilson and Boyd (5) by permission of Elsevier Publishing Co., Figure 6 was reproduced from Boyd et al. (12) by permission of Academic Press. The author also wishes to acknowledge the many contributions of Drs. L. T. Burka, B. J. Wilson, B.V.R. Sastry, T. M. Harris, and R. A. Neal to this work.

## REFERENCES

- Wilson, B. J., et al. A lung oedema factor from mouldy sweet potatoes (*Ipomoea batatas*). *Nature* 231: 52 (1971).
- Boyd, M. R., and Wilson, B. J. Isolation and characterization of 4-ipomeanol, a lung-toxic furanoterpenoid produced by sweet potatoes (*Ipomoea batatas*). *J. Agr. Food Chem.* 20: 428 (1972).
- Boyd, M. R., Wilson, B. J., and Harris, T. M. Confirmation by chemical synthesis of the structure of 4-ipomeanol, a lung-toxic metabolite of the sweet potato (*Ipomoea batatas*). *Nature* 236: 158 (1972).
- Boyd, M. R., et al. Lung-toxic furanoterpenoids produced by sweet potatoes (*Ipomoea batatas*) following microbial infection. *Biochim. Biophys. Acta* 337: 184 (1974).
- Wilson, B. J., and Boyd, M. R. Toxins produced by sweet potato roots infected with *Ceratocystis fimbriata* and *Furarium solani*. In: *Mycotoxins*, I.F.H. Purchase, Ed., Elsevier Publishing Co., Amsterdam, 1974, Chap. 15.
- Wilson, B. J., Yang, D.T.C., and Boyd, M. R. Toxicity of mould-damaged sweet potatoes (*Ipomoea batatas*). *Nature* 227: 521 (1970).
- Peckham, J. C., et al. Atypical interstitial pneumonia in cattle fed moldy sweet potatoes. *J. Amer. Vet. Med. Assoc.* 160: 169 (1972).
- Gillette, J. R., Mitchell, J. R., and Brodie, B. B. Biochemical mechanisms of drug toxicity. *Ann. Rev. Pharmacol.* 14: 271 (1974).
- Bend, J. R., et al. A comparative study of the hepatic and pulmonary mixed function oxidase systems in the rabbit. *J. Pharmacol. Exptl. Therap.* 183: 206 (1972).
- Gram, T. E., Litterst, C. L., and Mimnaugh, E. G. Comparative aspects of drug metabolism by mammalian lung and liver: mixed function oxidation and conjugation reactions. In: *Drug Interactions*, P. L. Morselli, S. Garattini, and S. N. Cohen, Eds., Raven Press, New York, 1974, pp. 103-110.
- Matsubara, T., et al. The preparation of microsomal fractions of rodent respiratory tract and their characterization. *Cancer Res.* 34: 2196 (1974).
- Boyd, M. R., Burka, L. T., and Wilson, B. J. Distribution, excretion, and binding of radioactivity in the rat after intraperitoneal administration of the lung-toxic furan, [ $^{14}\text{C}$ ]-4-ipomeanol. *Toxicol. Appl. Pharmacol.* 32: 147 (1975).
- Boyd, M. R., et al. Role of covalent binding in the toxic mechanism of the lung-edemagenic agent, 4-ipomeanol. *Fed. Proc.* 33: 234 (1974).
- Boyd, M. R., unpublished results.
- Staub, N. C. Pulmonary edema. *Physiol. Rev.* 54: 678 (1974).
- Gillette, J. R. A perspective on the role of chemically reactive metabolites of foreign compounds in toxicity-II. Alterations in the kinetics of covalent binding. *Biochem. Pharmacol.* 23: 2927 (1974).
- Boyd, M. R. Hepatotoxicity produced by the lung-toxic furanoterpenoid, 4-ipomeanol, after mixed-function oxidase induction: reversal of target organ for toxicity and covalent binding in rats pretreated with 3-methylcholanthrene. *Toxicol. Appl. Pharmacol.* 33: 132 (1975).
- Swenson, D. H., Miller, J. A. and Miller, E. C. 2,3-dihydro-2,3-dihydroxyafatoxin B1 adduct formed by hamster and rat liver microsomes *in vitro*. *Biochem. Biophys. Res. Commun.* 53: 1260 (1973).
- Mitchell, J. R., et al. Hepatic necrosis caused by furose-mide. *Nature* 251: 508 (1974).
- Boyd, M. R., Wilson, B. J., and Sastry, B.V.R. Acute toxicity and development of tolerance to 4-ipomeanol, a lung-edemagenic toxin from sweet potatoes (*Ipomoea batatas*) (Abstract). Fifth Intl. Congr. Pharmacol., San Francisco, Calif., July 23-28 (1972).
- Boyd, M. R., et al. Studies on the mechanism of tolerance development to the pulmonary toxicity of 4-ipomeanol. *Toxicol. Appl. Pharmacol.* 33: 135 (1975).
- Ugazio, G., Koch, R. R., and Recknagel, R. O. Mechanism

- of protection against carbon tetrachloride by prior carbon tetrachloride administration. *Exptl. Mol. Pathol.* 16: 281 (1972).
23. Delucia, A. J., et al. Ozone interaction with rodent lung; effect on sulfhydryls, and sulphhydryl-containing enzyme activities. *J. Lab. Clin. Med.* 80: 559 (1972).
  24. Wilson, B. J., and Boyd, M. R., unpublished results.
  25. Kilburn, K. H. Modes of alveolar response to insult. In: *Environmental Factors in Respiratory Disease*, D.H.K. Lee, Ed., Academic Press, New York, 1972, pp. 39-59.
  26. Cross, C. E. The granular type II pneumocyte and lung antioxidant defense. *Ann. Intern. Med.* 80: 409 (1974).
  27. Fairchild, E. J. Tolerance mechanisms. *Arch. Environ. Health* 14: 111 (1967).
  28. James, M. O., Fouts, J. R., and Bend, J. R. Hepatic and extrahepatic metabolism, *in vitro*, of an epoxide (8-<sup>14</sup>C-styrene oxide) in the rabbit. *Biochem. Pharmacol.*, 25: 187 (1976).
  29. Grover, P. L. K-region epoxides of polycyclic hydrocarbons: formation and further metabolism by rat-lung preparations. *Biochem. Pharmacol.* 23: 333 (1974).
  30. Witschi, H. Exploitable biochemical approaches for the evaluation of toxic lung damage. In: *Essays in Toxicology*, Vol. 6, W. J. Hayes, Ed., Academic Press, New York, 1975, Chap. 5.
  31. Gram, T. E., Litterst, C. L., and Mimnaugh, E. G. Enzymatic conjugation of foreign chemical compounds by mammalian lung and liver. *Drug Metab. Disposition* 2: 254 (1974).
  32. Boyd, M. R., and Neal, R. A. Studies on the mechanism of toxicity and of development of tolerance to the pulmonary toxin,  $\alpha$ -naphthyl thiourea (ANTU). *Drug Metab. Disposition* 4: 314 (1976).
  33. Boyd, M. R., and Osborne, B. A. Studies on a microsomal nitroreductase in lung and liver which catalyzes covalent binding of <sup>14</sup>C-nitrofurantoin to pulmonary and hepatic protein. *Fed. Proc.* 34: 756 (1975).
  34. Grover, P. L., Hewer, A., and Sims, P. Metabolism of polycyclic hydrocarbons by rat lung preparations. *Biochem. Pharmacol.* 23: 323 (1974).
  35. Reid, W. D., et al. Metabolism and binding of aromatic hydrocarbons in the lung: relationship to experimental bronchiolar necrosis. *Ann. Rev. Resp. Dis.* 107: 539 (1973).
  36. Mattocks, A. R. Mechanisms of pyrrolizidine alkaloid toxicity. In: *Pharmacology and the Future of Man*. Proc. 5th Int. Congr. Pharmacology, San Francisco, 1972, Vol. 2, pp. 114-23.
  37. Rechnagel, R. O., and Glende, E. A., Jr. Carbon tetrachloride hepatotoxicity: An example of lethal cleavage. *CRC Crit. Rev. Toxicol.* 2: 263 (1973).