

Synopsis of Research Articles

Mixing Exploitation and Conservation: A Recipe for Disaster

Liza Gross | DOI: 10.1371/journal.pbio.0040418

Most governments around the world set conservation policy based on the assumption that resource exploitation and species protection can co-exist in the same place. These policies have led to Orwellian “marine protected areas” that host commercial fishing operations, leading one to wonder who’s protecting whom. A new study reveals the danger of this approach and shows that it’s time to let protection mean protection.

For decades, the Dutch government sanctioned mechanical cockle dredging in three-fourths of the intertidal flats of the Wadden Sea—a natural monument protected under two intergovernmental treaties. Before suction dredging began in the 1960s, an estimated 2,000 tons of cockles were hand-harvested from the reserve each year. In 1989, the high-pressure, motor-driven water pumps used in suction dredging sucked up close to 80,000 tons of cockles. By 2004, the Dutch government decided the environmental costs were too great and stopped the practice.

Jan van Gils and colleagues investigated the ecological impacts of commercial cockle dredging on intertidal ecosystems by studying a long-distance migrant shorebird that dines principally on cockles, the red knot (*Calidris canutus islandica*). Up to 50% of the global red knot population uses the Dutch Wadden Sea at some point during their annual cycle.

Red knots are exquisitely adapted to their lifestyle. They have a pressure-sensitive bill that senses hard objects buried in the sand and a shell-crushing gizzard to accommodate the birds’ penchant for swallowing their catch whole. They even have a flexible digestive system that minimizes the energy costs of flying up to 16,000 kilometers between their arctic breeding grounds and winter homes in Europe and the tropics—their gizzard expands and contracts to balance daily food intake and energy needs.

To determine the effects of dredging on the birds, the authors sampled prey quality and density over 2,800 Wadden Sea sites during the late summer months (late July to early September) for five years starting in 1998. Dredging occurred each year from September to December, immediately after their sample collections. In undredged areas, cockle densities increased by 2.6% each year, and the quality remained stable. In dredged areas, cockle densities remained stable, and their quality (flesh-to-shell ratio) declined by 11.3% each year—paralleling the decline in the quality of the birds’ diet (as measured by droppings). This finding falls in line with evidence that dredging disturbs the silt cockles like to settle in, as well as their feeding conditions—which in turn reduces their quality as a food resource.

Based on prey quality and densities, Van Gils et al. predicted the energy intake rate for knots with an average-size gizzard at each site (all sites were pooled into 272 blocks, each with an area of 1 square kilometer), then calculated the percentage of blocks that would not yield sufficient intake rates for knots to avoid starvation. From 1998 to 2002, the percentage of blocks that couldn’t sustain knots increased from 66% to 87%—all attributable to dredging in previously



DOI: 10.1371/journal.pbio.0040418.g001

Commercial shellfish dredging in the Dutch Wadden Sea led to declines in both the quality and amount of the red knot’s food resources, causing the population to crash. (Photo: Jan van de Kam)

suitable sites. Reduced prey density caused some of this degradation, but most stemmed from declines in both cockle density and quality.

The authors caught and color-banded the birds so they could estimate survival rates the following year, and they measured gizzard mass with ultrasonography. As expected, when prey quality declined, birds needed larger gizzards to process the relatively higher proportion of shells in their diet. Their chances of surviving conditions at the Wadden Sea increased as a function of prey quality and gizzard flexibility. Birds that did not return had much smaller gizzards than those that did. Survival rate calculations based on gizzard size and prey quality revealed that if birds could not expand their gizzard and prey quality was low (0.15 grams of flesh per gram of shell), only 47% of arriving birds would avoid starvation. A much greater proportion would survive if their gizzard could expand by at least 1 gram (70% for 1 gram, 88% for 2 grams).

These degraded food conditions, the authors conclude, explains why red knot populations have declined by 80% in the Wadden Sea. And increased mortality in the Wadden Sea—which the authors estimate at 58,000 birds over five years—accounts for the 25% decline of red knots across their entire northwest European wintering grounds. Dredging

reduced the quality of red knots' primary food source so drastically that even the birds' extraordinarily adaptable digestive system could not save them. The authors point out that dredging doesn't even provide significant economic benefits—only 11 outfits manage 22 fishing boats—yet is “directly responsible” for the widespread decline of a protected shorebird. These findings put the lie to the notion that commercial exploitation is consistent with conservation and underscore the risks of disturbing critical habitat for threatened or endangered species.

van Gils JA, Piersma T, Dekinga A, Spaans B, Kraan C (2006) Shellfish dredging pushes a flexible avian top predator out of a marine protected area. DOI: 10.1371/journal.pbio.0040376

Cellular Inheritance

Emma Hill | DOI: 10.1371/journal.pbio.0040446

Biological continuity relies on successful cell division. Research over the years has provided a good understanding of how cells divide to form two daughter cells through mitosis. During mitosis, chromosomes are duplicated and divided up between the cells to provide each daughter cell with a complete copy of the organism's genome. The cell, however, doesn't contain only genomic DNA but can accumulate damage in the form of misfolded proteins. How does the cell discard this unwanted material during mitosis?

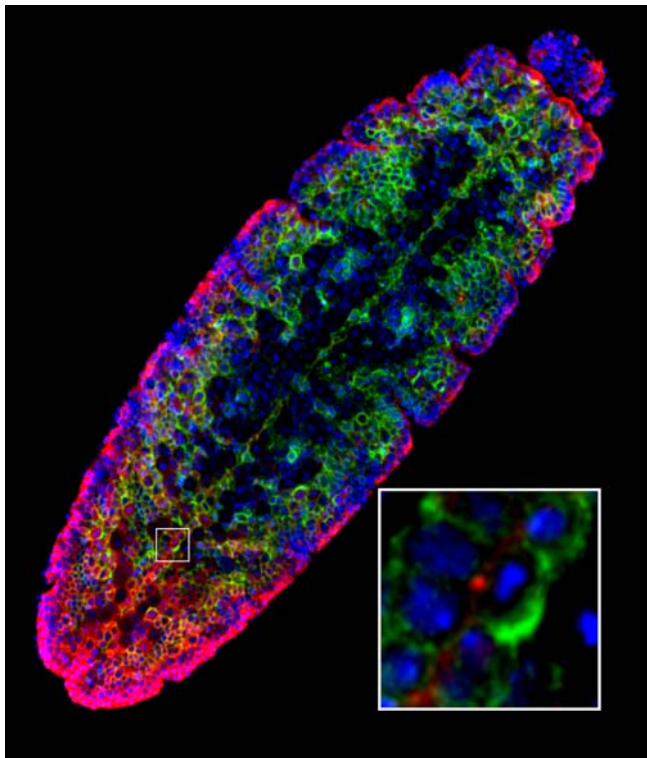

DOI: 10.1371/journal.pbio.0040446.g001

Aggregates of disease-associated misfolded or stress-damaged proteins can be stored at the microtubule organizing center and are inherited during mitosis with a polarity that ensures preservation of the long-lived progeny.

Many diseases, including Huntington and Parkinson disease, can be attributed to protein misfolding that aggregates and accumulates in the cell. The underlying genes have nucleotide triplet-repeat mutations, which produce a protein with an expanded run of the same amino acid, commonly glutamine. Proteins with such polyglutamine stretches fold and function incorrectly. Misfolded proteins are generally targeted for degradation by the cell. However, at some point, the cellular mechanisms are overwhelmed, and aggregated protein will accumulate within the cell as aggresomes.

What happens next to these cells in terms of cell division was the question that Maria Rujano, Harm Kampinga, and colleagues set out to investigate. Can cells with accumulated damage undergo cell division and complete mitosis? And if so, what happens to the aggresome? These researchers found intriguing evidence of a system in eukaryotic cells (which contain nuclei and other double-membraned organelles) that distributes damage asymmetrically, with one daughter cell inheriting the aggresome and the other being damage-free. In cases of polarized cell division (where one cell becomes committed to a specific fate and the other doesn't), this asymmetric mitosis favors leaving the long-lived committed daughter cell damage-free.

The researchers investigated multiple eukaryotic cell systems starting with human and hamster cells. They engineered the cells to transiently express a modified version of the *huntingtin* gene with a glutamine repeat that causes misfolding. As expected, a large number of cells had aggresomes, which allowed the authors to investigate whether the cells could undergo mitosis and divide and then determine what happened to the aggresomes. Cells with severe levels of damage were unable to progress through mitosis. However, in the single-aggresome-containing cells, the cell appeared normal throughout all phases of mitosis. In addition, only one daughter cell inherited the damage. Time-lapse imaging confirmed these results and also found that cells with aggresomes do take a little longer to complete mitosis than normal cells. So it seems that cells with aggresomes that are formed from expanded polyglutamine repeats are able to successfully complete mitosis.

To take this observation a step further, the authors looked to see what happens in the dividing cells of polarized tissues. For this they make use of two systems: intestinal crypt cells from two human patients with the neurodegenerative disorder spinocerebellar ataxia type 3 and *Drosophila* neuroblast stem cells expressing a mutated polyglutamine form of the *huntingtin* gene. Because both of these cells divide to produce one short-lived daughter cell and one long-lived differentiated cell, the authors could investigate how accumulated damage was distributed between the two different daughter cells.

In the human system in which the stem cells give rise to one short-lived committed progenitor and differentiated cells, the authors saw that the stem cells themselves, which should in theory have accumulated aggregates over their longer lives, never actually contain aggresomes, whereas the committed and differentiated cells from these samples do contain damaged inclusion bodies. This is consistent with asymmetric inheritance of aggresomes by the shorter-lived non-stem cell after division. At this time, however, the researchers are unable to verify this hypothesis, because no mitotic stem cells are detected in this model.

In the *Drosophila* model, the neuroblast stem cells divide into one neuroblast (that will undergo several rounds of division before succumbing to a natural death at the end of embryogenesis) and one fate-committed ganglion mother cell (GMC) (that will go on to become a long-lived glial cell). By studying *Drosophila* embryos, the authors could visualize both expression of the mutated *huntingtin* gene and aggresome formation. They identified mitotic neuroblast cells, all of which expressed the mutated form of *huntingtin*, though few contained aggresomes. More interestingly, in all of the mitoses analyzed, the aggresome-like inclusion was inherited by the neuroblast daughter cell resulting in formation of a damage-free GMC. These observations provide strong evidence that these neural precursor cells undergo asymmetric distribution of

aggregated proteins with a polarity, such that the long-lived committed daughter cell is favored and does not inherit the damage.

So it seems that damage-riddled cells can still divide and complete mitosis. Rujano and colleagues show this to be true in several different systems. Indeed, cells appear to have developed a clever damage-limitation system to ensure that specific long-lived daughter cells are not encumbered with damage from the parent cell. Future research will hopefully shed light on how this decision is made and what the mechanisms underlying this system are.

Rujano MA, Bosveld F, Salomons FA, Dijk F, van Waarde MAWH, et al. (2006) Polarised asymmetric inheritance of accumulated protein damage in higher eukaryotes. DOI: 10.1371/journal.pbio.0040417

Demonstrating the Theory of Ecological Speciation in Cichlids

Liza Gross | DOI: 10.1371/journal.pbio.0040449

The geological history of Africa's Lake Victoria, the second largest freshwater lake in the world, provided the raw materials for investigating one of the most compelling hypotheses for the origin of species: ecological speciation. After drying out three times over its 400,000-year history, the lake refilled about 15,000 years ago, and the few cichlid fish species that had retreated to fluvial habitats returned, rapidly fanning out into hundreds of new species to fill different ecological niches.

Though Lake Victoria cichlids appear millions of years younger than their counterparts in nearby Lake Malawi, both groups display an enormous range of physical and behavioral traits. This staggering diversity in such young species provides compelling evidence for adaptive radiation, which occurs when divergent selection operates on ecological traits that favor different gene variants, or alleles, in different environments. When divergent selection on an ecological trait also affects mate choice—promoting reproductive isolation of diverging populations—ecological diversity and speciation may proceed in tandem and quickly generate numerous new species.

Despite substantial theoretical and some experimental support for such “by-product speciation,” few studies have shown that selection has “fixed” alleles (that is, driven its frequency in a population to 100%) with different effects on an adaptive trait in closely related populations. But now, Yohey Terai, Norihiro Okada, and their



DOI: 10.1371/journal.pbio.0040449.g001

The rapid evolution of African cichlid fish driven by strong divergent selection is revealed in a gene that influences both ecological adaptation and mate choice, in keeping with ecological by-product speciation.

colleagues have bridged that gap by demonstrating divergent selection on a visual system gene that influences both ecological adaptation and mate choice in cichlids.

Photoreceptors in the retina perceive light with visual pigments that consist of a light-absorbing chromophore (either A1 or A2) that sits inside an opsin protein. The chromophore interacts with several amino acids coating the opsin to determine the pigment's light sensitivity. In cichlids, opsins with the most variable sequences function at the opposite ends of the light spectrum: the short wavelength-sensitive opsin 1 (*SWS 1*) perceives ultraviolet blue, and the long wavelength-sensitive opsin (*LWS*) perceives red. Because

LWS shows five times more variation in Lake Victoria cichlids than it does in Lake Malawi cichlids—and species' spectral range matches male breeding coloration, a primary determinant in mate choice—the authors suspected the gene might simultaneously affect ecological adaptation and mate choice.

The authors sequenced hundreds of *LWS* alleles from four Lake Victoria cichlid species inhabiting different microhabitats. Both *Mbipia mbipi* and *Neochromis greenwoodi*/*N. omnicaeruleus* (grouped together based on their similar characteristics) live outside rocky crevices in the lake's turbid depths, though their depth ranges differ. *N. rufocaudalis* also lives outside rocky crevices, but inhabits shallow

waters like *Pundamilia pundamilia*, which live among the crevices. Transparent waters transmit broad spectra; turbid waters shift the visual spectrum toward red. The authors predicted that populations of the deeper-living species—*N. greenwoodi*/*N. omnicaeruleus* and *M. mbipi*—would be affected by light transmission with different water clarity (which was not an issue for those living in shallow waters).

They focused on *LWS* polymorphisms in opsin amino acids that would alter light sensitivity, grouping them into L and H alleles. L alleles were fixed (or nearly so) in turbid-water dwelling populations; H alleles were fixed in populations accustomed to transparent water. Finding a strong positive correlation between *LWS* divergence and transparency, the authors determined that significant differentiation in *LWS* sequences (that is, population variation in allele frequencies) resulted from divergent selection. And, as expected, they found only weak sequence differentiation

between the populations in shallow, transparent waters. Divergent selection acted on the *LWS* alleles only between *N. greenwoodi*/*N. omnicaeruleus* and *M. mbipi* populations from different water transparencies, the authors concluded, “strongly implicating divergent adaptation to different photic environments.”

To test the adaptive implications of divergence, the authors reconstituted pigments from H and L alleles along with A1 or A2 chromophores and measured their light-absorption range. A1 pigments absorbed the same spectra in H and L alleles, but the A2 pigment caused a red shift only in the L allele—likely reflecting an adaptation to the longer wavelengths found in turbid waters. And how did divergent light sensitivity compare with male breeding color? The populations that diverged according to water transparency also diverged in male breeding coloration—some *N. greenwoodi*/*N. omnicaeruleus* males are yellow-red and some *M. mbipi* are yellow. In turbid waters, both yellow and red travel farther than blue light,

and the populations with alleles shifted toward the longer yellow and red wavelengths had a higher frequency of males with corresponding yellow-red or yellow males. Why all males haven’t evolved red and yellow breeding coloration is a question the authors are currently studying.

Altogether, these results demonstrate that by-product speciation—driven by strong divergent selection in a gene controlling an ecological trait that affects mate choice—fueled the rapid evolution of African cichlids. The colorful cichlids have proven invaluable in illuminating the mechanisms of speciation. But biologists now face a race against time to plumb their secrets: an estimated 50% of cichlids vanished in the 1980s and appear to be disappearing ten times faster than they can be described.

Terai Y, Seehausen O, Sasaki T, Takahashi K, Mizoiri S, et al. (2006) Divergent selection on opsins drives incipient speciation in Lake Victoria cichlids. DOI: 10.1371/journal.pbio.0040433

Iron Regulation and an Opportunistic AIDS-Related Fungal Infection

Liza Gross | DOI: 10.1371/journal.pbio.0040427

Because HIV attacks the very cells charged with fighting infection, the virus compromises the body’s ability to co-exist with pathogens that are otherwise harmless. It is these pathogen-induced opportunistic infections, and not the virus itself, that produce the most debilitating effects of the disease. The appearance of specific opportunistic infections—including the life-threatening fungal infection cryptococcosis—signals progression to AIDS. Nearly all AIDS-related cryptococcosis cases worldwide are caused by *Cryptococcus neoformans*, a single-celled fungus originally isolated over 100 years ago.

A critical factor in *C. neoformans* infection is iron availability. Because iron also supports fundamental host cell processes, the pathogen must compete with the host to secure enough iron for survival and replication. Genetic and nutritional factors, along with HIV itself, promote iron accumulation in cells and organs, dramatically increasing its availability to *C. neoformans* and other potential pathogens. Understanding how pathogenic fungi sense host resources and control virulence-related factors is essential for developing effective antifungal therapies. In a new study, Won Hee Jung, James Kronstad, and colleagues identify a gene in *C. neoformans* that coordinates both processes, revealing a potentially powerful antifungal strategy. The gene, called *Cryptococcus iron regulator* (*CIR1*), regulates not only the pathogen’s response to iron but also its ability to establish virulent infection.

Studies in other fungi, including a harmless laboratory yeast, showed that cell-surface enzymes called reductases facilitate iron uptake by reducing extracellular iron (that

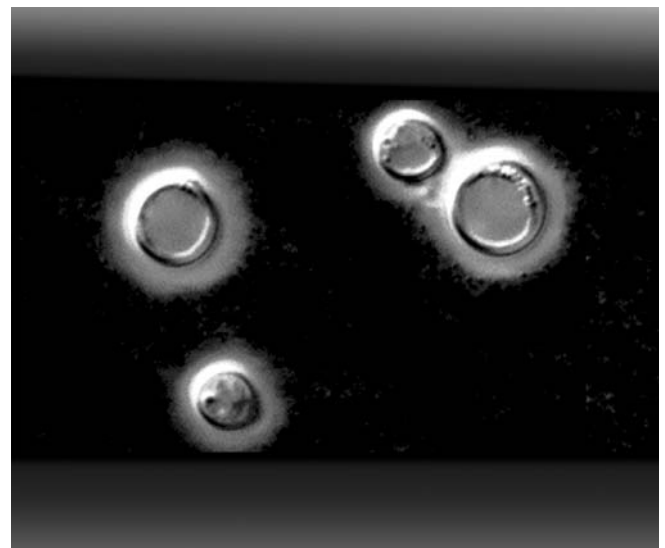

DOI: 10.1371/journal.pbio.0040427.g001

To establish virulent infection, *C. neoformans* must be able to grow at 37 °C, deposit melanin in the cell wall, and produce a polysaccharide capsule (displayed in the image).

is, transforming it into a biologically available state through electron transfer). Such studies also identified three transcription factors involved in maintaining the proper balance, or homeostasis, of cellular iron by repressing the components of the iron-uptake pathway. Using the sequences

of these transcription-repressing iron regulators, the authors identified *CIR1* as a candidate regulator in *C. neoformans*. Like the other regulators, the gene contains a region rich in cysteine bases and a “zinc finger motif,” which in the other regulators binds to the promoters of iron transporter genes.

To investigate *CIR1*'s function, the authors deleted its coding sequences from two *C. neoformans* strains. Loss of a transcriptional repressor in the laboratory yeast leads to increased cell-surface reductase activity (which is evident when a colorless indicator dye in the growth medium turns red from the enzyme's reducing activity). In contrast to the nonmutant, or wild-type, cells, *cir1* mutants appeared reddish. But when the authors added the *CIR1* gene to the mutant cells, they looked the same as the wild-type cells, indicating that the loss of *CIR1* led to increased reductase activity. Mutants also showed signs of sensitivity to excess iron, revealing *CIR1*'s role in iron homeostasis.

To examine how the mutation changed the transcription of iron-related genes, the authors grew mutant and wild-type strains in high and low iron concentrations and then analyzed their gene-expression profiles with microarrays. The profiles of mutant and wild-type strains showed “substantial” differences in both iron backgrounds, indicating that the Cir1 protein senses iron levels and coordinates gene expression accordingly. Genes involved in iron transport were most affected by iron availability and *CIR1* deletion. Based on the microarrays, the authors concluded that Cir1 represses iron uptake mediated by reductases but activates uptake mediated by transport molecules called siderophores. The arrays also

revealed that the gene influences melanin production, an important virulence factor that thwarts host antimicrobial proteins.

The authors explored the *cir1* mutation's effects on *C. neoformans* virulence in the wild-type and mutant strains and found that capsule formation—which disrupts the host's cellular defenses—was absent in mutant cells. This defect appears to arise in part because the mutation inhibits signaling pathways required for capsule formation. The mutants also showed substantial defects in an absolutely critical virulence factor: the capacity to grow at host body temperature (37 °C). The authors confirmed that *CIR1* exerts significant control over *C. neoformans* virulence in experiments with mice. Mice exposed to a normally virulent strain lacking *CIR1* showed no serious symptoms, while mice infected with strains containing the protein died within 20 days.

Altogether, these findings demonstrate that *CIR1* controls the expression of genes required for *C. neoformans* virulence—and that iron regulation plays a critical role in cryptococcal infection. This intimate connection between iron and virulence suggests that targeting *CIR1* or otherwise disrupting iron regulation might prove an effective strategy for controlling one of the most common life-threatening fungal infections in persons with AIDS.

Jung WH, Sham A, White R, Kronstad JW (2006) Iron regulation of the major virulence factors in the AIDS-associated pathogen *Cryptococcus neoformans*. DOI: 10.1371/journal.pbio.0040410

Genomic Insights into (Extreme) Life at the Bottom of the Sea

Liza Gross | DOI: 10.1371/journal.pbio.0040425

If you lived some 2,500 meters below the ocean's surface in waters oscillating between 2 ° and 40 °C, what sorts of genes would you need? In a new study, Kathleen Scott, Stefan Sievert, and their colleagues shed light on the special adaptations required for such extreme living by sequencing and analyzing the complete genome of the extremophilic bacterium *Thiomicrospira crunogena* XCL-2. First isolated in 1985 from deep-sea hydrothermal vents along the East Pacific Rise in the South Pacific, *T. crunogena* has since been found in both Atlantic and Pacific Ocean vents, revealing its critical role in these ecosystems. It belongs to the diverse group of bacteria called gammaproteobacteria, which includes the human pathogens *Escherichia coli* and *Salmonella*.

T. crunogena is what's known as an obligate chemolithoautotroph—it can grow using carbon dioxide as its sole carbon source and (in this case) sulfur as an energy source. Much like photosynthetic bacteria and plants use the sun's energy to produce food, *T. crunogena* uses the oxidation of reduced

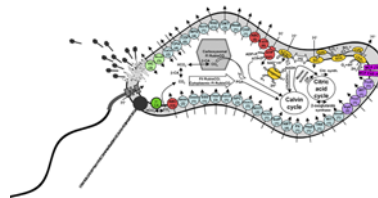

DOI: 10.1371/journal.pbio.0040425.g001

A model for metabolic function, based on the genome of *Thiomicrospira crunogena* XCL-2.

sulfur compounds as an energy source for carbon fixation (synthesizing carbon-based sugars and other molecules) and cellular maintenance. And like their photosynthetic counterparts, these chemolithoautotrophs function as primary producers at the base of their vent community.

Hydrothermal vents release geothermally heated seawater through fissures along the volcanically active mid-ocean ridge. These carbon dioxide- and sulfide-rich plumes periodically mix with cold, oxygenated bottom water, creating eddies and forcing hydrothermal vent communities to contend with

dramatic fluctuations in environmental conditions. One way *T. crunogena* copes with these oscillations is by using carbon-concentrating mechanisms that allow growth to continue when carbon dioxide levels drop. Scott et al. studied the content and structure of the microbe's genome for evidence of other adaptations required to thrive in its extreme environment.

The *T. crunogena* genome is confined to a single chromosome that is densely packed with genes involved in electron transport (used to gain energy from sulfur compounds), energy and carbon metabolism, along with those required for nucleotide and amino acid synthesis and other cellular processes. The authors found only one genetic system for energy generation (and a possible alternate), which is perhaps not surprising for a microbe with limited energy options. They found all the components of the Sox system, a sulfur-oxidizing pathway typically found in microbes with more flexible strategies for carbon and energy metabolism. Together, these Sox genes

completely oxidize, or strip electrons, from a variety of reduced sulfur-related compounds (producing sulfate). The microbe also harbors an enzyme that stops short of complete oxidation to sulfate (producing elemental sulfur instead). Because complete oxidation generates enough acid to inhibit growth, the authors suspect that this alternate pathway may curtail further acidification when acid levels rise.

In any case, *T. crunogena* appears to be the first obligate chemolithoautotrophic sulfur-oxidizing bacteria to rely primarily on the Sox system for oxidizing sulfur compounds, raising the possibility that either the Sox system evolved in *T. crunogena*'s obligate autotrophic ancestors or the microbe lost its flexibility but retained its Sox pathway. Interestingly, however, this obligate chemotroph, which spends its life affixed to a hydrothermal vent, has proportionally more regulatory and signaling molecules than a free-living planktonic species. This enhanced repertoire likely reflects the different demands of life in extreme, volatile conditions—which requires rapid, flexible cellular responses—compared with the relatively stable existence of plankton floating on the open ocean.

T. crunogena also has more flexibility in acquiring nutrients, based on the number of genes encoding transporters involved in the uptake of inorganic nitrogen and phosphate. And the microbe has a number of chemotaxis genes, which likely direct it to favorable microhabitats along the vent, as well as pilin genes, which allow it to set up shop in the best locations.

With the first complete genome of a cosmopolitan autotrophic hydrothermal vent bacterium, researchers can further explore the genetic and physiological mechanisms that allow life to thrive in hostile environments at the bottom of the sea. And by comparing the *T. crunogena* genome to the genomes of autotrophic bacteria living in hot springs and other extreme environments around the world, they can begin to piece together the evolutionary history of primary production at the boundaries of life.

Scott KM, Sievert SM, Abril FN, Ball LA, Barrett CJ, et al. (2006) The genome of deep-sea vent chemolithoautotroph *Thiomicrospira crunogena* XCL-2. DOI: 10.1371/journal.pbio.0040383

How the Human Brain Detects Unexpected Events

Liza Gross | DOI: 10.1371/journal.pbio.0040443

We've all had the experience of walking into a place we know well and immediately and apparently effortlessly noticing that something has changed—for example, the photo of your mother-in-law, once discretely displayed on a corner table, now occupies a prominent position on the mantle. Although neuroscientists have spent over 40 years investigating how the brain reacts to novel stimuli in the environment, they are only just beginning to understand how the brain detects “associative novelty,” where familiar objects appear in new configurations.

Computational models strongly suggest that the hippocampus plays a crucial role in novelty detection by perceiving disparities between expectations based on past experience and sensory reality. These models propose that the hippocampal CA1 region compares prior predictions emanating from the CA3 region with sensory inputs arriving from the nearby entorhinal cortex. “Associative mismatches,” therefore, result when current sensory inputs are at odds with what would be predicted based on stored representations. By this account, we only notice that the photo has moved because we have expectations, derived from past experience, about where it should be located. Until now, however, empirical evidence that the human hippocampus operates in this way has been lacking.

In a new study, Dharshan Kumaran and Eleanor Maguire used functional magnetic resonance imaging (fMRI) and behavioral experiments to explore the processing of sequence novelty (that is, temporal associative novelty) in humans. The authors examined brain responses to novel sequences of objects while participants performed an incidental target-detection task designed to emphasize the automatic processing of novelty. Participants first saw four novel objects presented in consecutive order, followed after a brief delay, by the presentation of the same objects in one of three orders: the same, half-new (first two objects in the same order and the last two in reverse order), or entirely new. The authors used nearly 1,000 images, so that individuals saw each object only twice during the experiment (once during

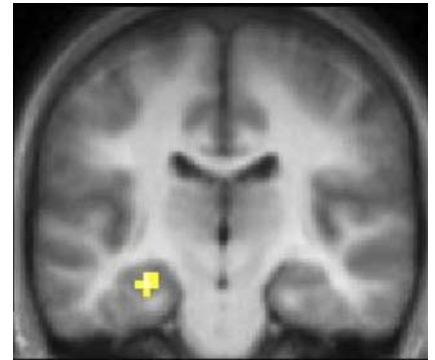

DOI: 10.1371/journal.pbio.0040443.g001

Hippocampal activity signals the presence of a mismatch between what is expected to happen and what actually does.

the first and second presentations).

This experimental design allowed the authors to identify whether novelty-related responses reflected the operation of comparison-based associative match-mismatch computations, or alternatively, a more general response to sequence novelty per se. Critically, an associative mismatch situation only arises in the half-new condition, where predictions derived from prior experience (that is, the first presentation), and cues by the first two objects in the sequence are violated.

The authors looked for differences in brain activity between the three possible sequential orders in which objects could appear during the second presentation. Although hippocampal activity was initially indistinguishable for the repeated and half-new sequence order, it increased substantially in the half-new situation when the third object appeared and was different from the one expected. Thus, the hippocampus was maximally engaged when reality ran counter to prior expectations about what would happen next, and not in response to sequence novelty per se. Moreover, this violation of expectations had a striking effect on subjects' behavior: in a separate experiment, participants' reaction times markedly slowed in the presence of associative mismatch in the half-new condition.

This study provides direct evidence that the hippocampus acts as an associative match-mismatch detector (or comparator device) and

responds, not to novelty per se, but to discrepancies between expected and received signals in the environment. In contrast, the entorhinal cortex, a region with strong reciprocal connections with the hippocampus, exhibited a different pattern of neural activation consistent with a more general response to sequence novelty. These findings also provide empirical support for the view that the hippocampus plays a critical role in storing representations of event sequences and, specifically, in

replaying entire stored sequences in response to a partial input cue (the first object in the sequence). And it may be this unique capability that underlies the essential role of the hippocampus in recalling the details of an event, and perhaps even the episodic vignettes that tell the story of one's life.

Kumaran D, Maguire EA (2006) An unexpected sequence of events: Mismatch detection in the human hippocampus. DOI: 10.1371/journal.pbio.0040424

A New Theory for the Evolution of Genomic Imprinting

Liza Gross | DOI: 10.1371/journal.pbio.0040421

When Watson and Crick solved the structure of DNA in 1953, the mechanism of heredity was immediately apparent in the pairing of the nucleotide bases. And the history of life, it appeared, could be inferred by decoding the messages written in their sequence. But it has become increasingly clear that heritable changes in gene expression can occur without alterations in DNA sequence. These “epigenetic” mechanisms can alter gene activity by chemically modifying the DNA or the proteins that envelop it.

One epigenetic mechanism, called genomic imprinting, has proven especially puzzling, because it appears to undermine the benefits that multicellular organisms gain from inheriting two copies, or alleles, of nearly every gene. (If one allele is damaged, the activity of the other can often compensate.) In genomic imprinting, only the gene inherited from one parent is expressed; the other is silenced by a chemical “stamp,” thereby forfeiting the advantage of having two alleles. Errors in imprinting have been linked to cancer and some genetic diseases. Why would selection favor a “mono-allelic” expression pattern for genes that exposes the organism to genetic injury?

In a new study, Jason Wolf and Reinmar Hager address these issues with a new theory for the evolutionary origins of genomic imprinting. Providing an alternative to the dominant model, the authors show that the expression of maternally derived



DOI: 10.1371/journal.pbio.0040421.g001

Natural selection favors the sole expression of maternal gene copies, because it allows for the genetic coadaptation of maternal-offspring traits and leads to higher offspring fitness.

genes allows for the coadaptation of complementary traits between mother and offspring and enhances offspring development and fitness.

The dominant model explains asymmetric parental gene expression in terms of conflict. In one scenario, the conflict arises over maternal investment, such that paternally expressed growth factor genes, for example, would require more maternal investment during development while maternally expressed growth inhibitors would require less, with different implications for offspring fitness. Alternately, genomic imprinting might mitigate intralocus sexual conflict—which occurs when gender-specific

selection favors different alleles in males and females—by allowing high-fitness alleles to pass from mothers to daughters and from fathers to sons.

But these conflict theories don't account for evidence of genetic coadaptation between mother and offspring—based on correlations between offspring begging behavior in birds and maternal response, for example. The authors' model does account for such evidence, however, by demonstrating that when selection favors such coadaptation between maternal and offspring traits, evolution may lead to maternal expression at genomic loci underlying these traits. Coadaptation could arise through two different selection modes: pleiotropy and linkage disequilibrium. In pleiotropy, one genomic locus with two alleles affects both the maternal and offspring trait—a condition the authors explored through a single-locus model. In linkage disequilibrium, trait-related alleles are linked in the genome; this case was explored in a two-locus model in which two separate loci (each with two alleles) affect the maternal and offspring trait. Both models assume that selection favors coadaptation by linking offspring fitness to the combined genomic expression of mother and offspring.

To determine whether either model favors the evolution of genomic imprinting, the authors mathematically analyzed the relationship between the level of imprinting and the average fitness of individuals. Imprinting will be favored, they found, when genetic variation exists for coadapted traits. Since genetic variation for maternal and offspring traits “appears ubiquitous” in natural populations, it's likely that this variation influences the evolution of imprinting, the authors conclude. Genomic imprinting increases population mean fitness, they explain, by increasing the adaptive melding of maternal and offspring traits.

How does the theory play out in practice? A recent study in mice showed that every gene that is exclusively imprinted in the placenta was maternally expressed—suggesting the genes' critical role in placental development—and supporting the model's prediction that genes involved in “intimate maternal-offspring interaction” are more likely to show

maternally expressed imprinting. This prediction can be experimentally tested in organisms for which such intimate interactions have significant fitness implications, such as plant-eating insects. In this case, offspring survival depends on where the mother deposits the eggs, and one would expect to see genetic coadaptation for traits affecting oviposition site and offspring performance.

Though their study focused on maternal-offspring interactions, the authors expect coadaptation to occur

between father and offspring when the father is the primary caregiver, which describes many fish and arthropod species. Their theory also provides researchers with a roadmap for testing alternative hypotheses for the origins and targets of genomic imprinting—which are likely to vary with the taxa under study.

Wolf JB, Hager R (2006) A maternal-offspring coadaptation theory for the evolution of genomic imprinting. DOI: 10.1371/journal.pbio.0040380

the elongation was a direct result of the reorientation of the cell divisions by P_2 .

To investigate the role of Wnt signaling in this process, Bischoff and Schnabel carried out similar experiments using blastomeres from embryos with mutations in the gene that encodes the MOM-2/Wnt signaling molecule. When the added P_2 cell lacked Wnt, the anterior cells failed to elongate or to orient toward P_2 . The same effect was seen when the AB-derived blastomeres lacked the Wnt receptor MOM-5/Frizzled, showing that P_2 induces reorientation and elongation by producing Wnt, which stimulates Frizzled receptors on AB-derived cells.

The properties of this polarizing center were tested using various arrangements of blastomeres. When two AB blastomeres were added to opposite sides of one P_2 cell, both oriented toward P_2 , showing that it signals in all directions. P_2 can orient the granddaughter cells of AB as well as the daughter cells, and the daughter cells of P_2 have the same effect. Furthermore, the polarizing signal can reach cells that do not touch P_2 . If the intervening AB descendants lack the ability to produce Wnt, however, the signal does not reach the cells that are not touching P_2 , showing that the polarizing Wnt signal is transduced from cell to cell by a relay mechanism—each cell, when stimulated by Wnt, in turn produces Wnt to stimulate its neighbors. To confirm this finding, the authors showed that AB cells that had been oriented by a P_2 cell could orient other AB descendants even when the P_2 blastomere had been removed. This is the first demonstration that cell polarity is passed on from cell to cell by a so-called relay mechanism.

This simple mechanism could have parallels in other organisms, such as *Drosophila* and vertebrates, where it is also necessary to organize polarity in fields of cells. Further work will also be needed to investigate how this mechanism is related to the initial anterior-posterior organization of the zygote by *par* genes, which give rise to the initial distinction between anterior and posterior cells.

Bischoff M, Schnabel R (2006) A posterior centre establishes and maintains polarity of the *Caenorhabditis elegans* embryo by a Wnt-dependent relay mechanism. DOI: 10.1371/journal.pbio.0040396

Back to Front in *C. elegans*

Rachel Jones | DOI: 10.1371/journal.pbio.0040426

An enduring question in biology is how a single cell—the fertilized egg, or zygote—can generate the incredible complexity and variety of tissues of a complete organism. Much of this process depends on the establishment and maintenance of polarity, both in single cells and within a population of cells. Simply put, how does a cell or an embryo know its front from its back?

In a new study, Marcus Bischoff and Ralf Schnabel show that the polarization of the *Caenorhabditis elegans* embryo depends on a “polarization center” that is formed by the descendants of one of the two initial blastomeres—the cells that result from the first division of the zygote. The posterior blastomere gives rise to a group of cells that are responsible for the anterior-posterior organization of most of the embryo.

It has been clear for some time that posterior cells in the early *C. elegans* embryo could influence the orientation of their anterior neighbors and that this influence depends on the signaling molecule Wnt. Bischoff and Schnabel used experiments in which they cultured different combinations of blastomeres to investigate the extent and mechanisms of this effect.

When the anterior blastomere (AB) is isolated from the posterior (P_1) cell at the two-cell stage, the dividing cells form a spherical shape. Each cell divides along a cleavage axis; in cultures of isolated anterior blastomeres, the direction of cleavage rotates by about 90° after each division, and the divisions fall along an axis that deviates

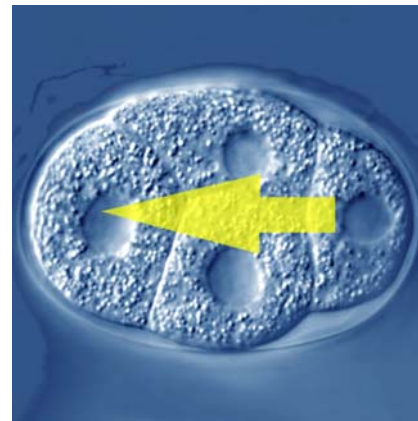

DOI: 10.1371/journal.pbio.0040426.g001

The posterior P_2 blastomere polarizes the four-cell embryo, thereby organizing the cleavage directions of cells—which shapes the embryo and directs cell-fate determination.

from the anterior-posterior axis by about 63°. The embryonic fragments formed by this process are spherical. In normal embryos, the descendants of AB cleave along an axis that falls about 45° away from the anterior-posterior axis, and the embryos are elongated.

When the authors added a P_2 blastomere—one of the descendants of P_1 —to the isolated anterior cells, it caused a shift in the orientation of division toward the P_2 cell, even in those anterior blastomeres that didn't touch the added cell. It also caused the spherical embryonic fragments to elongate, and the elongation and shift in orientation of division were highly correlated. Further analysis showed that

Fishy Cooperation

Frans B. M. de Waal | DOI: 10.1371/journal.pbio.0040444

It is commonly thought that animals can be arranged along a ladder of intelligence—a sort of modern-day *Scala Naturae*—with humans inevitably at the top, followed by our close relatives, the primates, all the way down to fish and other slimy creatures.

Over the past decade, this ladder has been challenged by claims of high intelligence and great social complexity in other animals. For example, spotted hyenas (*Crocuta crocuta*) establish hierarchies in which dominant females support the rank contests of their daughters. Bottlenose dolphins (*Tursiops aduncus*) form “political” coalitions every bit as complex as those of chimpanzees. Caledonian crows (*Corvus moneduloides*) not only use tools in the wild, but also modify tools in the lab, an ability once thought to define humans.

And now come the fish. It started with a provocative challenge to primate supremacy with the claim that “culture” (that is, socially transmitted behavior) is at least as well developed in fish as it is in primates. While this may be a bit of an exaggeration, a new study on cooperative behavior by Redouan Bshary and his colleagues really makes one wonder if there is anything fish cannot do.

The article describes the astonishing discovery of coordinated hunting between groupers (*Plectropomus pessuliferus*) and giant moray eels (*Gymnothorax javanicus*) in the Red Sea. These two species make a perfectly complementary pair. The moray eel can enter crevices in the coral reef, whereas the grouper hunts in open waters around the reef. Prey can escape from the grouper by hiding in a crevice and from the moray eel by leaving the reef, but prey has nowhere to go if hunted by a combination of these two predators.

The article offers a description and accompanying videos, such as the one showing a grouper and eel swimming side by side as if they are good friends on a stroll. It also offers quantification, which is truly hard to achieve in the field, of the tendencies involved in this mutually beneficial arrangement. The investigators were able to demonstrate that the two predators seek each other’s company, spending more time together than expected by chance. They also found that groupers actively recruit moray eels through a curious

head shake made close to the moray eel’s head to which the eel responds by leaving its crevice and joining the grouper. Groupers showed such recruitment more often when hungry.

Given that cooperative hunting increases capture success for each of the two predators, and that they don’t share with each other but swallow the prey whole, their behavior seems a form of “by-product mutualism,” defined as a form of cooperation in which both parties achieve rewards without sacrificing anything for the other. They are both out for their own gain, which they attain more easily together than alone.

The observed role division comes “naturally” to two predators with different hunting specializations, and is therefore far simpler to achieve than for members of the same species. Also, recruitment is quite common in the animal kingdom—for example, primates have specialized signals to solicit each other’s support in fights. What is truly spectacular about this study is that the entire interaction pattern—two actors who seemingly know what they are going to do and how this will benefit them—is not one we usually associate with fish. This is probably because we tend to develop cognitively demanding accounts for our own behavior and believe that absent the same cognition, the behavior simply cannot take place. It is very well possible, however, that our accounts overestimate the amount of intelligence that goes into complex behavior. Moreover, we have a tendency to underestimate the intelligence of animals at lower rungs of the evolutionary ladder.

In fact, it is the ladder idea itself that is wrong. The best way to approach animal intelligence is from an evolutionary and ecological perspective focused on the tasks that each species faces in nature. In this regard, these two reef predators show us that if it comes to survival, highly intelligent solutions are within the reach of animals as different from us as fish. (Watch a grouper signal to a giant moray eel resting in a cave by shaking its head in front of the moray in this video. DOI: 10.1371/journal.pbio.0040431.sv001)

Bshary R, Hohner A, Ait-el-Djoudi K, Fricke H (2006) Interspecific communicative and coordinated hunting between groupers and giant moray eels in the Red Sea. DOI: 10.1371/journal.pbio.0040431

Small Change: Study of Enhancer Supports Evolution Model

Richard Robinson | DOI: 10.1371/journal.pbio.0040419

To the layperson, one fruit fly may look pretty much like another. But there are, in fact, nearly 4,000 distinct species, differing in such observable characteristics as the pattern of veins on the wings or the position of bristles on the thorax. These genetically controlled differences have evolved over millions of years, since the first ancestral fruit fly arose. And it’s not just flies, of course—every species has evolved a unique form, correlated with

subtle but telling differences in their genes.

Despite the ubiquity of this phenomenon, the exact genetic underpinnings of the morphological differences between two closely related species are known in very few cases. In a new study, Sylvain Marcellini and Pat Simpson explore the sequences controlling the minutest of differences between two fruit fly species and show that the appearance of two versus

four thoracic bristles is due to small sequence changes in the regulatory region of a single gene shared between the two species.

Adult flies bear numerous mechanosensory hairs, or bristles, in rows along the back of the thorax. *Drosophila melanogaster* bears two such bristles, while *D. quadricolor* bears four. Bristle formation is due to expression of the *scute* gene, which is under the control of numerous

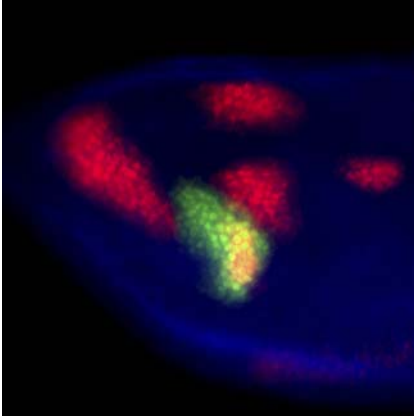

DOI: 10.1371/journal.pbio.0040419.g001

In the wing discs of *Drosophila* species, the divergent activities of proneural enhancers (orange versus green nuclei) contribute to the evolution of the adult bristle patterns.

genetic sequences, including so-called enhancers—nearby DNA sequences that bind transcription factors and enhance gene expression. One, called the dorsocentral enhancer (DCE), has

been well characterized in flies and is known to interact with a transcription factor called Pannier.

When the authors compared the sequences of the DCEs of *D. quadrilineata* and *D. melanogaster*, they discovered that both contained binding sites for Pannier, but the sequences were significantly different in other respects, consistent with the 60 million years of evolution separating them. By staining developing flies of both species to reveal *scute* expression, they showed that the *D. quadrilineata scute* is expressed more anteriorly than the *D. melanogaster scute*, in exactly the locations that later sprout the extra bristles. When the authors inserted the *D. quadrilineata* DCE into *D. melanogaster*, the *scute* gene was active more anteriorly, and the flies developed four, instead of two, bristles, mimicking the phenotype of the *D. quadrilineata* fly. Importantly, this effect could not be reproduced

when the control DCE from a different two-bristle fly was inserted.

These results provide evidence for a common model of morphologic evolution, in which slight changes in enhancers lead to slight changes in the expression domains of specific genes, leading to slight changes in the phenotype of the organism. Such small individual changes don't necessarily alone lead to speciation, but the accumulation of such differences, combined with and reinforcing the behavioral isolation of two diverging groups, may result in the creation of a new species. While this model is widely accepted, actual examples of enhancer-driven phenotypic differences have been scarce, and so these results provide important evidence to strengthen it.

Marcellini S, Simpson P (2006) Two or four bristles: Functional evolution of an enhancer of *scute* in *Drosophilidae*. DOI: 10.1371/journal.pbio.0040386

Building a Better Mouse Map

Mary Hoff | DOI: 10.1371/journal.pbio.0040422

Genetic maps of the mouse genome—which identify the relative locations of specific stretches of DNA based on the likelihood of their being separated when chromosomes exchange parts during meiosis—work well for broadly defining where various points lie along a mouse's chromosomes. But these maps have lacked the resolution that investigators need to be able to do things like line them up against physical maps—the string of As, Gs, Cs, and Ts that gene sequencing supplies—to identify the precise location of genes, or explore the nuances of genetic recombination. Because the mouse is a widely used model for genetic research, such capabilities would be invaluable. Now, Sagiv Shifman, Jonathan Flint, and colleagues have provided a powerful new tool for genetic studies with the development in mice of the most detailed genetic map available for any species but humans.

To create the high-resolution map, the researchers used two groups of mice, one consisting of outbred, heterogeneous stock (HS) and the other of recombinant inbred lines (RI). Physical mapping of the mouse genome has revealed the location of thousands of single nucleotide polymorphisms (SNPs)—stretches of DNA whose genetic code differs from one animal to another (or one homologous chromosome to another) by only one nucleotide base and that can be used as landmarks in the mapping process. The researchers looked at the patterns of inheritance of 10,202 SNPs in HS animals and 11,609 SNPs in RI animals, then used special software to calculate their relative location based on how likely they are to occur together. Using this process, they were able to create genetic maps of the mouse genome that can distinguish between two points 0.37 cM (centiMorgans, a measure of relative distance based on recombination frequency) apart in



DOI: 10.1371/journal.pbio.0040422.g001

Genetically heterogeneous mice, derived from eight inbred strains, were used at the 50th generation for genetic mapping.

HS and 0.45 cM apart in RI—far more finely tuned than the best previous map.

After developing the super maps, the researchers used them to study recombination rates of various genes by comparing genetic and physical distances. For HS, the average recombination rate was 0.63 cM per megabase (cM/Mb), and for RI, it was 0.62 cM/Mb. But the recombination rate varied substantially from one part of the genome to another. Smaller chromosomes, for instance, had a higher average recombination rate than larger ones. There was also a difference between the study groups: the HS genome showed a higher recombination rate in big chromosomes and a lower rate in small chromosomes than did the RI genome. And when they looked at variation in recombination rate along the chromosome, the researchers found the highest recombination rate near the ends of the chromosomes (on structures called telomeres).

There was also a sex difference in recombination rates. Calculating rates separately for male and female

HS mice, the researchers found, as previous studies had found in humans, that the average autosomal (non-sex chromosomes) recombination rate for females was higher than that for males. Distribution of recombination frequencies differed with sex, too, with recombination higher near the junctures of the sister chromosomes (centromeres) in females and higher near telomeres in males. The researchers also found many individual areas along the chromosomes that showed high recombination rates in one sex but not the other.

Intrigued by the incongruity in recombination, the researchers decided to look further into how rates vary with specific DNA features. In HS and RI together, they found a total of 494 regions in which recombination rates were uncharacteristically high (which they termed “jungles”) or low (“deserts”). The researchers looked at 55 inbred strains for places with little historical recombination. They found that 59% of deserts overlapped with such areas, while only 12% of jungles overlapped.

Can sequence characteristics predict jungles and deserts? In general, the researchers found more simple repeats but

not more genes or SNPs in jungles. Self-copying stretches known as long interspersed nuclear elements (LINEs) were more common in deserts than in jungles. Sequences previously found to be prevalent in human recombination hot spots (CCTCCCT and CCCACCCC) turned out to appear disproportionately often in the mouse genome jungles as well. In fact, the researchers found that the CCTCCCT motif appeared in locations corresponding to mouse jungles and deserts in rats, dogs, and chimpanzees, as well as in humans.

In the brief period of its existence, this new, improved mouse genetic map has already yielded valuable information on how factors such as chromosome, chromosomal location, sex, and sequence composition are related to recombination rates—information that can improve our understanding of inheritance and inform future efforts to pinpoint the precise location of genes on individual chromosomes.

Shifman S, Bell JT, Copley RR, Taylor MS, Williams RW, et al. (2006) A high-resolution single nucleotide polymorphism genetic map of the mouse genome. DOI: 10.1371/journal.pbio.0040395

For Some Sensory Neurons, Motor Response Shapes Their Output

Richard Robinson | DOI: 10.1371/journal.pbio.0040429

Among the biggest surprises in the early days of neurobiology was the discovery that some sensory neurons responded most when a stimulus was presented just so. When a bar in the visual field, for instance, was oriented not too much this way, not too much that way, but with exactly the right inclination, the neuron’s firing rate was maximum and tailed off in either direction. Such single-peaked responses are well understood as an efficient means to encode information about orientation and other features—whether visual, auditory, or tactile.

But single-peaked response curves are not the only kind. In fact, monotonic curves—those which steadily increase or decrease without a middle peak—are ubiquitous among sensory neurons. They are especially common in the somatosensory system, which includes those sensors that tell us what is touching our skin and how our body is moving and that provide vital information for controlling muscles. For many of these neurons, more stimulus means more response.

A long-standing question in theoretical neurobiology is what general conditions promote monotonic, rather than single-peaked, response curves? In a new study, Emilio Salinas provides evidence that monotonic sensory inputs are favored when monotonic motor outputs are

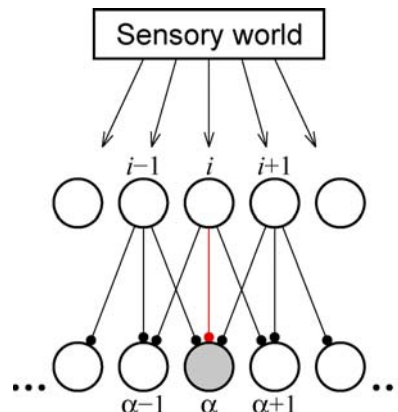

DOI: 10.1371/journal.pbio.0040429.g001

The author describes a computational model in which sensory information is received by one set of neurons (i) and transferred to another set (α), which control behavior.

desired. More generally, he shows that the shapes of the optimal sensory response curves should be matched to the type of the motor output that they are linked to.

The author began by constructing the simplest of mathematical models, in which a small number of sensory neurons are directly linked to a larger number of motor neurons (in complex nervous systems such as ours, several layers of intervening neurons mediate between the two). He asked what kind

of sensory responses would be needed to drive the desired output of the nervous system, such as a monotonic motor response. The model provided several possible answers, including single-peaked sensory curves. However, the most efficient type of sensory activity—the one that achieved the highest accuracy and highest tolerance to noise from the fewest neurons—was one where the sensory responses were also monotonic.

This model provides insight into several heretofore unexplained observations. Binocular vision allows the two eyes to be focused using information about the disparity between the current focal length and the desired one. When the disparity is great, a relatively large and stereotyped oculomotor response is required to quickly achieve focus; when the disparity is small, the behavioral response is less constrained, so a larger variety of eye movements is possible. Several different kinds of visual processing neurons that respond to binocular disparity have been discovered and are generated by the model as well. One kind, which includes neurons that respond monotonically to large disparities, most likely helps to drive the large refocusing response.

The author’s linkage of motor output to sensory curve shape also

helps explain a curious aspect of single-peaked response curves, namely their variety of possible widths. A narrow curve is produced by a neuron tightly tuned to its ideal stimulus—it fires very little when the stimulus varies even slightly from the ideal. A broad curve, on the other hand, indicates a neuron that is responsive to a wider range of inputs. Salinas shows that this variation is expected when the motor response must vary. The bat, for instance, must maneuver faster as it gets closer to its prey, and studies have shown that its

echolocation system includes both broadly and narrowly tuned auditory sensors, which are most active when the prey is far or near, respectively. The author proposes that the broader maneuvers of the bat far from its prey are driven more by the more broadly tuned sensors, while the more rapid motor responses as it closes in are linked with the narrowly tuned sensors. Initial data from animal experiments support this model.

Linking the shape of the sensory response curves to the motor actions

that may follow a stimulus provides a theoretical framework for the existence of monotonic response curves. This may help explain the wide diversity of sensory curves seen in a variety of situations, including collision avoidance, orienting responses, evasive maneuvers, and other well-defined sensorimotor behaviors.

Salinas E (2006) How behavioral constraints may determine optimal sensory representations. DOI: 10.1371/journal.pbio.0040387

A Human Taste for Rarity Spells Disaster for Endangered Species

Liza Gross | DOI: 10.1371/journal.pbio.0040439

The shady pursuit of endangered bird eggs made international headlines in May 2006 when Colin Watson, widely considered Britain's most notorious illegal egg collector, died after falling from a 12-meter tree, allegedly while hunting a rare egg. (Watson's son Kevin has publicly claimed that his father hadn't collected an egg since the practice was banned in 1985.) The Royal Society for the Protection of Birds estimates that up to 30 of Britain's most vulnerable species are targeted by collectors.

Classical economics theory predicts that such exploitation is unlikely to extinguish a species because the cost of finding the last individuals would outweigh the benefits. But a new theoretical study shows that adding human behavior to the equation—specifically, the human penchant for rarity—reveals an unexpected mechanism of exploitation, with alarming implications for species survival. Franck Courchamp, Elena Angulo, and their colleagues incorporated the assumption that rarity increases a species' value into a classic model of resource exploitation used to manage fisheries. Prizing rarity, they found, triggers a positive feedback loop between exploitation and rarity that drives a species into an extinction vortex.

This phenomenon, the authors explain, resembles an ecological process called the Allee effect, in which individuals of many plant and animal species suffer reduced fitness at low population densities, which increases their extinction risk. Reduced survival or reproduction can occur if individuals fail to find mates, for example, or suffer increased mortality by losing the benefits of pack hunting (more access to prey) or foraging in groups (minimized predation risk). Most studies assume the Allee effect is an intrinsic species trait that human activity cannot artificially induce. But the authors' model shows that humans can trigger an "anthropogenic Allee effect" in rare species through a paradox of value. When rarity acquires value, prices for scarce species can skyrocket, even though continued exploitation will precipitate extinction.

The model predicts that as long as there is a positive correlation between a species' rarity and its value, and the market price exceeds the cost of harvesting the species, harvesting will cause further declines, making the species ever rarer and more expensive, which in turn stimulates even more harvesting until there's nothing left to harvest.



DOI: 10.1371/journal.pbio.0040439.g001

By placing an exaggerated value on rarity, humans can drive rare species into a vortex of extinction, through a process called the anthropogenic Allee effect. (Image: Maria Angulo)

And as long as someone will pay any price for the rarest of the rare, market price will cover (and exceed) the cost of harvesting the last giant parrot, tegu lizard, or lady's slipper orchid on Earth.

The authors describe multiple human activities that could precipitate the anthropogenic Allee effect. Hobby collections of the sort Watson allegedly gave his life for top their list. Overhunting for food and feathers pushed the great auk (*Pinguinus impennis*)—a flightless, now-extinct bird that laid only one egg a year—to the brink of extinction. But it was likely scientists and museum collectors anxious to nab an increasingly rare specimen, the authors suggest, that finished the bird off. And trophy hunting collectors have placed increasing pressure on rare species as their focus has shifted from killing the most dangerous animals to killing the rarest.

The pursuit of social status and health can also trigger the anthropogenic Allee effect, as many rare species are coveted as luxury items—whether for handbags, exotic cuisine, or dining room furniture—or traditional medicines. The exotic pet trade continues to threaten orangutans, monkeys, reptiles, birds, and wild cats, as well as a wide variety of arachnids, insects, and fish. The great majority of targeted animals die during capture or transport and never even reach the consumer. And it appears that pet trade dealers read the scientific literature for clues to the next hot species: immediately after an article recognized the small Indonesian turtle (*Chelodina mccordi*) and Chinese gecko (*Goniurosaurus luii*) as rarities, their prices soared. The turtle is now nearly extinct and the gecko can no longer be found in its southeastern China niche.

Even well-intentioned activities like ecotourism can destabilize threatened populations. A recent study of killer whales in the North Pacific found an inverse relationship between the number of whale-watching boats one year and a reduced whale population size the next, in keeping with evidence that motorized boats can lower whale fitness. The study also found that the smaller population size one year didn't discourage whale watching tours the next year, but stimulated interest, based on the larger number of boats.

How to conserve biodiversity when simply declaring a species endangered catalyzes its exploitation? Since many collectors, pet owners, and ecotourists actually care about biodiversity, the authors hope that education may go a long way toward curbing these human activities. Education could even mitigate the damage of trophy hunting and luxury consumption if society stigmatized activities responsible for driving a species to extinction and people could no longer take pride in displaying such “treasures.” But for those who prize rarity above all else, only strengthened regulations and interventions will decrease the probability of a coveted species' extinction. And until those protections are firmly in place and enforceable, biologists may do well to think twice before reporting a species' decline.

Courchamp F, Angulo E, Rivalan P, Hall RJ, Signoret L, et al. (2006) Rarity value and species extinction: The anthropogenic Allee effect. DOI: 10.1371/journal.pbio.0040415

New Mouse Hippocampal Cells Born in Pups and Adults Function Similarly

Mary Hoff | DOI: 10.1371/journal.pbio.0040441

For the most part, the production of new brain cells in mammals occurs only in immature individuals at the time the nervous system is undergoing development. One notable exception is the hippocampus, a part of the brain involved in memory and spatial perception. Hippocampal cells called dentate granule cells (DGCs) develop in adults as well as in young animals. How these “adult-born” cells build their connections with the rest of the brain, and the extent to which they resemble “pup-born” cells, is of great interest to those who would like to coax other parts of adult brains to make new cells as a strategy for reversing the loss of function from trauma or degenerative disorders.

The development of DGCs is linked to hippocampus-related learning and behavioral changes. Developing, adult-born DGCs have different properties than mature neurons that arose when the brain was developing. Do the adult-born cells keep their distinct traits, or do they become functionally similar to the cells that developed early in life? To find out, Diego Laplagne, Alejandro Schinder, and colleagues compared the structure and function of these

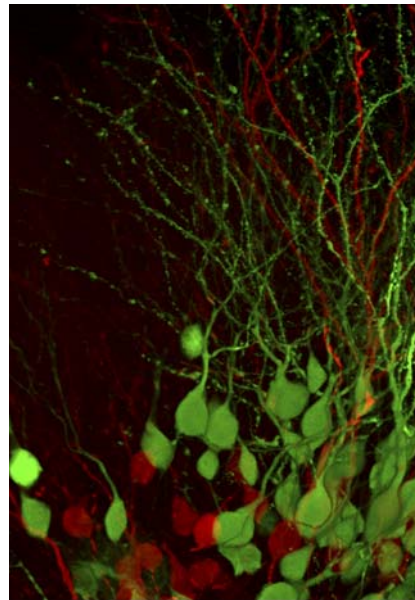

DOI: 10.1371/journal.pbio.0040441.g001

Dentate granule cells generated in the developing and adult hippocampus retrovirally labeled with green and red fluorescent proteins.

“new kids on the block” with DGCs that developed in the perinatal period in mice.

The researchers' first task was to figure out a way to distinguish between pup-born and adult-born DGCs in brain tissue that contained both. To accomplish that task, they used retroviruses to introduce one kind of fluorescent protein into the developing DGCs at 7 days after birth and a second protein into the adult mouse brain at 42 days after birth. As a result of this treatment, the pup-born cells fluoresced green and the adult-born cells fluoresced red, making them readily distinguishable in brain slices.

Once they could tell the two types of cells apart, the researchers began testing a variety of electrophysiological traits of the connections between DGCs and neurons providing excitatory and inhibitory inputs. Using brain slices obtained from 19-week-old mice that had undergone the retrovirus labeling earlier in life, they looked at glutamatergic (excitatory) nerves connecting the hippocampus with the entorhinal cortex, another brain area associated with memory. When they stimulated the afferent excitatory neurons (which carry information from the neocortex to the hippocampus), the researchers evoked similar excitatory

postsynaptic currents (EPSCs) in both pup-born and adult-born DGCs. When given paired-pulse stimulation, in which two pulses of electricity are given close together, the two types of cells showed a very similar reduction in EPSCs with the second pulse, suggesting that the short-term plasticity of the synapses is identical. And when the cells were given high-frequency stimulation, EPSC amplitude was depressed in both cell types in a similar manner. Thus, the researchers concluded that excitatory inputs to pup-born and adult-born DGCs are functionally similar.

Next the researchers looked at GABAergic (inhibitory) inputs from interneurons that connect to the body and dendrites of the DGCs. Using brain slices from 14-week-old mice, they stimulated the incoming inhibitory neurons from the granule cell layer (GCL) and molecular

layer (ML) of the hippocampus and found no significant difference in the amplitude and kinetics of inhibitory postsynaptic currents (IPSCs) that resulted. Spontaneous IPSCs, which add information about GABAergic inputs from areas other than the GCL and ML, exhibited similar frequency, amplitude, and kinetics in the pup-born and adult-born cells.

Having shown that pup-born and adult-born DGCs respond to both excitatory and inhibitory inputs in the same way, the researchers next turned their attention to how the two types of cells integrate the signals from the various inputs to produce an action potential (which transmits the signal), or spike. Spiking probability varied among neurons but was not distinguishable between the two cell types, further supporting the earlier indications that adult-born and pup-

born DGCs function in fundamentally the same way.

With glutamatergic and GABAergic inputs handled similarly and the action-potential response indistinguishable, the researchers concluded that mature adult-born and pup-born DGCs are functionally similar. This means that at least some neurons that develop in adult brains can form connections that are indistinguishable from connections formed by neurons that develop early in life—a hopeful finding for those who have set their sights on one day being able to repair damaged or deteriorated brain tissue.

Laplagne DA, Espósito MS, Piatti VC, Morgenstern NA, Zhao C, et al. (2006) Functional convergence of neurons generated in the developing and adult hippocampus. DOI: 10.1371/journal.pbio.0040409

Containing the Damage of Unfolded Proteins

Liza Gross | DOI: 10.1371/journal.pbio.0040442

The first stop for proteins bound for secretion from the cell or tethered to its membrane is the endoplasmic reticulum (ER). After secretory gene transcripts are translated into amino acid chains by ribosomes on the ER, they enter the ER's labyrinthine network of membranes as extended polypeptide chains. Once the polypeptides are inside, ER enzymes assemble, modify, and fold them into their proper 3-D conformation in preparation for the next stop on the secretory pathway.

When protein-folding demand exceeds ER capacity and clogs up the system with incorrectly folded proteins, sensors on the ER membrane stimulate the “unfolded protein response” (UPR). This ER-to-nucleus signaling pathway controls a vast gene-expression program that adjusts ER processing capacity and restores homeostasis by adjusting the size of the ER compartment, enlisting protein-folding enzymes, regulating the entry of amino acid chains, and removing irreparably folded proteins through the ER-associated protein degradation pathway.

In a new study, Sebastián Bernales, Kent McDonald, and Peter Walter report a surprising link between another protein-degradation pathway, called autophagy, and the UPR. They show that as yeast cells expand their ER to accommodate increased demand, they also synthesize autophagosome-like bodies that sequester stacks of membrane from the expanded ER. This mechanism may allow the ER to keep the protein production line operating at a steady state even as misfolded proteins accumulate, and it may also control the size of this organelle.

To characterize the UPR's effect on ER structure and size, Bernales et al. chemically induced the UPR in yeast cells. Electron microscopy analysis revealed a “massive expansion” of the ER in treated cells compared with untreated cells.

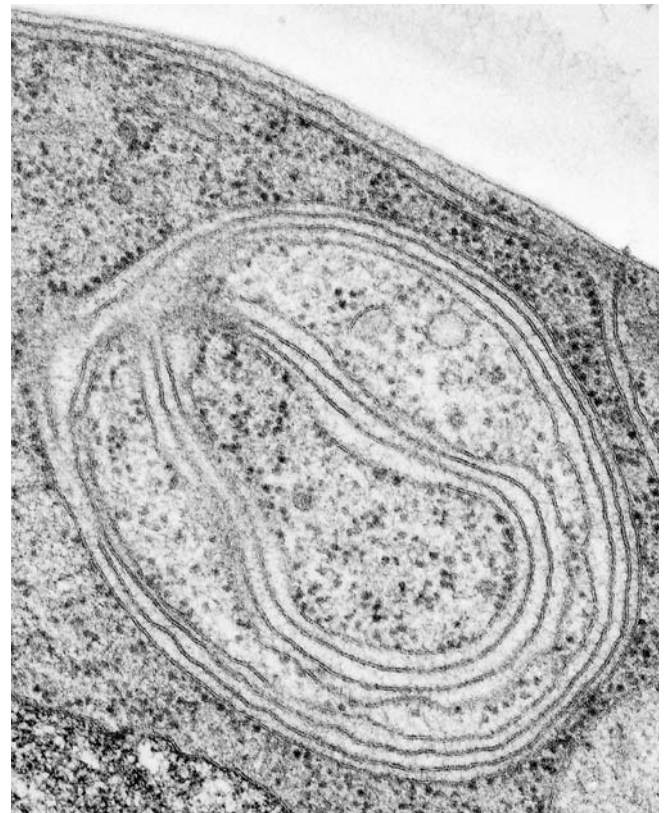

DOI: 10.1371/journal.pbio.0040442.g001

Cutting-edge electron-microscopy visualization techniques revealed that portions of both the internal membranes and the sequestering double-membrane envelope of the ER-containing autophagosome contain membrane-bound ribosomes.

In yeast, the primary UPR sensor, Ire1, triggers the UPR by promoting the synthesis of the transcriptional activator Hac1. When the authors directly activated Ire1's downstream transcriptional targets without causing protein misfolding (by artificially activating Hac1 production), they saw a similar increase.

On closer inspection of UPR-induced cells, the authors were surprised to see an abundance of "autophagosome-like structures packed with tightly stacked membrane cisternae." The structures were surrounded by double membranes like autophagosomes and were about the same size. The authors called them ER-containing autophagosomes (ERAs) after determining that their membrane contents came from the ER, based on the presence of ribosomes and other ER proteins and extensive membrane visualization analysis. Three hours after UPR induction, the majority of cells had proliferated ERs and about 20% of cells had ERAs. None of the ERA-containing cells had an expanded ER, suggesting that ERAs provide a means to downsize the ER to counteract expansion.

Given the ERAs' structural resemblance to autophagosomes, the authors reasoned that they may function similarly as well. In autophagy, cells recycle excess or worn out organelles (and sections of cytoplasm) by packaging them into autophagosomes that fuse with vesicles (vacuoles or lysosomes) equipped with protein-digesting acid hydrolases. Starvation induces macro-autophagy, which indiscriminately cannibalizes cytoplasm sections to release nutrients from degraded molecules. By contrast, ERAs are highly selective in sequestering ER membranes.

To investigate ERA function, the authors tracked the fate of an early component of autophagosome formation, Atg8, using a fluorescent version of the protein. In nitrogen-starved yeast, Atg8 concentrates in pre-autophagosomal structures

(PASs) near the vacuole, where Atg8's fluorescent domain is removed. It is thought that PASs stimulate the formation of autophagosomes, which then fuse with the vacuole and dump their contents. As expected, nitrogen starvation upregulated Atg8 (but not the UPR relay signal). Chemically induced UPR also increased Atg8 production, but did not cleave Atg8's fluorescent domain, indicating that Atg8's fate differs under these different physiological stresses. But more surprising, this result identifies the autophagy gene *ATG8* as a UPR target.

The authors go on to show that UPR induction produces a "vast proliferation" of Atg8-containing PASs, located near vacuoles or ERAs (when cells had them). Since no ERAs formed in cells lacking *ATG8*, the gene appears to play a part in ERA formation. *ATG8*, along with five other autophagy genes, is also required for cell growth under UPR-inducing conditions.

Altogether, these results establish a surprising link between autophagy and the UPR. Autophagy, the authors conclude, supplements the UPR by selectively "self-eating" excess ER to help cells weather the potentially fatal consequences of ER stress—in contrast to starvation-induced autophagy, which cannibalizes cellular contents for their metabolites. Intriguingly, autophagy genes can be enlisted by Ire1 but also independently of the Ire1-dependent UPR pathway, thus providing a rich platform for exploring alternative ER-to-nucleus signaling pathways in yeast. Future studies can begin to characterize the molecular mechanisms required for ERA formation and more fully explore the cellular functions of "ER-phagy."

Bernales S, McDonald KL, Walter P (2006) Autophagy counterbalances endoplasmic reticulum expansion during the unfolded protein response. DOI: 10.1371/journal.pbio.0040423

Reconfirming the Traditional Model of HIV Particle Assembly

Liza Gross | DOI: 10.1371/journal.pbio.0040445

For HIV infection to take hold, a virus particle must first attach to a cell to gain entry. Once inside, the viral genome is reverse transcribed from RNA to DNA, and then integrated into the host genome. By co-opting the host's molecular machinery, the virus churns out multiple copies of its genome (transcribed back into RNA), and viral components are synthesized and assembled into particles that leave the cell and begin the cycle anew. Viral assembly is mediated by the virus's major structural protein, Gag, which can be fused to another viral protein, Pol, which encodes the virus's enzymes.

In the traditional model, Gag proteins assemble at the plasma membrane prior to release. Multiple studies have recently challenged this model, however, showing abundant Gag proteins and mature virions in structures called endosomes, which take up extracellular molecules and particles through a process called endocytosis. These studies proposed that Gag is first sent to endosomal membranes before reaching the plasma membrane or extracellular space through an endosome-based transport pathway.

Initial studies described this endosomal assembly pathway as unique to macrophages, the primary targets of HIV infection, though other studies have suggested it may occur in all cell types. In a new study, Nolwenn Jouvenet, Paul

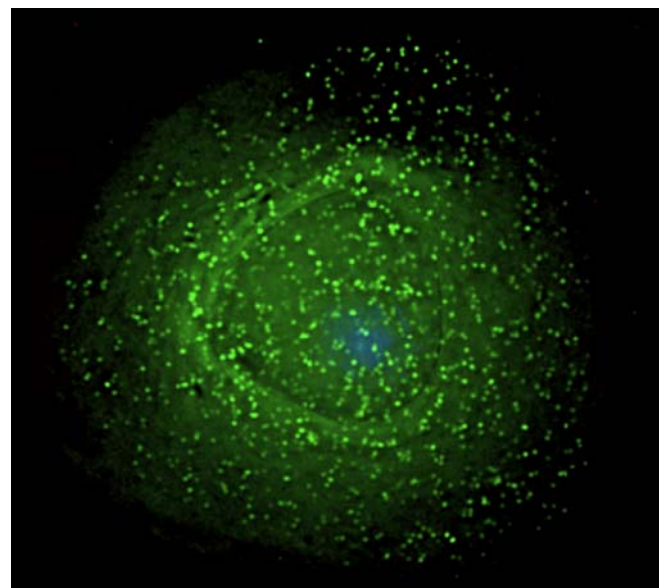

DOI: 10.1371/journal.pbio.0040445.g001

HIV-1 particles assembling at the surface of an infected macrophage.

Bieniasz, and their colleagues combined pharmacological, genetic, biochemical, and microscopic approaches to determine where HIV assembles in the cell. Their results undercut several elements of the endosomal model and place the traditional model back on a solid foundation.

To track HIV Gag localization and assembly, the authors started by transiently inducing Gag protein expression in a standard experimental cell line (293T cells). About 10 hours after transfecting cells with the *Gag* gene, they detected Gag-Pol processing, an indicator of assembly, and particle release. If Gag targeting to endosomes initiates particle assembly or transport to the membrane, the authors reasoned, then both processes should depend on endosome motility. But when cells were treated with a drug that blocks endosome movement, HIV assembly was unaffected, based on Gag processing and particle release. Further, microscopic analysis showed high levels of fluorescently tagged Gag proteins at the plasma membrane. Thus, they concluded, neither Gag transport to the plasma membrane nor virion assembly relied on endosome motility.

Fluorescently tagged Gag proteins were seen either scattered throughout the cytoplasm, assembled at the plasma membrane (about 4 hours after transfection), or accumulating both in internal compartments and at the plasma membrane (8–10 hours after transfection). The internal compartments turned out to be endosomes (based on characteristic protein markers), and the authors suspected that their accumulated Gag contents had been acquired through endocytosis; when they used genetic tools to block endocytosis, the endosomal Gag accumulations were no longer evident. What's more, inhibiting endosomal Gag had no effect on virion assembly and release.

The authors also manipulated Gag's membrane-binding domain to assess the consequences on viral assembly and release. If Gag is initially sent to endosomes to trigger HIV assembly and release, then exchanging Gag's membrane-binding protein with a domain that targets endosomes should precipitate particle assembly and release. But that's not what the authors found. Gag and Pol proteins that were artificially targeted to the plasma membrane triggered virion assembly and release just as efficiently as their wild-type (nonmanipulated) counterparts, but direct targeting of Gag proteins to endosomes resulted in particle assembly in endosomes but little or no particle release.

The authors repeated these experiments in macrophages, one of the virus's natural targets, using a new technique that facilitates transfection in macrophages. Localization patterns of newly synthesized Gag proteins followed a temporal pattern similar to that seen in the 293T cells. Just 4–6 hours after transfection, fluorescently tagged Gag proteins were either distributed throughout the cytoplasm or clustered at the plasma membrane. At 24 hours, Gag was also seen in internal compartments. And similar to what was found in 293T cells, inhibiting endosomal transport in macrophages revealed that endosomes cannot support virion assembly and release in these cells either.

Altogether, these results reaffirm the long-established model that Gag-mediated particle assembly occurs at the plasma membrane. Virions seen in endosomes arrive there through an endocytic pathway at a later point, which does not support HIV release. In fact, the authors argue, assuming a slow rate of Gag synthesis and a high rate of plasma membrane internalization, one would expect most HIV Gag

particles to wind up in endosomes. Future studies can further explore the kinetics that determine the rate at which virions are released or sequestered in cellular compartments. But the authors argue that their results unequivocally demonstrate that HIV assembly occurs at the plasma membrane.

Jouvenet N, Neil SJD, Bess C, Johnson MC, Virgen CA, et al. (2006) Plasma membrane is the site of productive HIV-1 particle assembly. DOI: 10.1371/journal.pbio.0040435

How to Protect Fly Photoreceptors

Rachel Jones | DOI: 10.1371/journal.pbio.0040438

When a nerve is injured, axons beyond the site of injury die through a process called Wallerian degeneration. This degeneration is delayed in mice that have a mutation called *Wallerian degeneration slow (Wld^s)*; these mice have three copies of a particular stretch of their DNA. Because this piece of DNA includes the gene for nicotinamide mononucleotide adenylyltransferase (NMNAT), which synthesizes a molecule called NAD, there has been a great deal of interest in whether NMNAT or NAD can protect against axonal degeneration. Hugo Bellen and colleagues show that NMNAT can, at least in the fruitfly *Drosophila*—and that its protective ability is independent of its function as a NAD synthase.

Investigations into the putative protective role of NMNAT have produced conflicting results. In vitro evidence supports

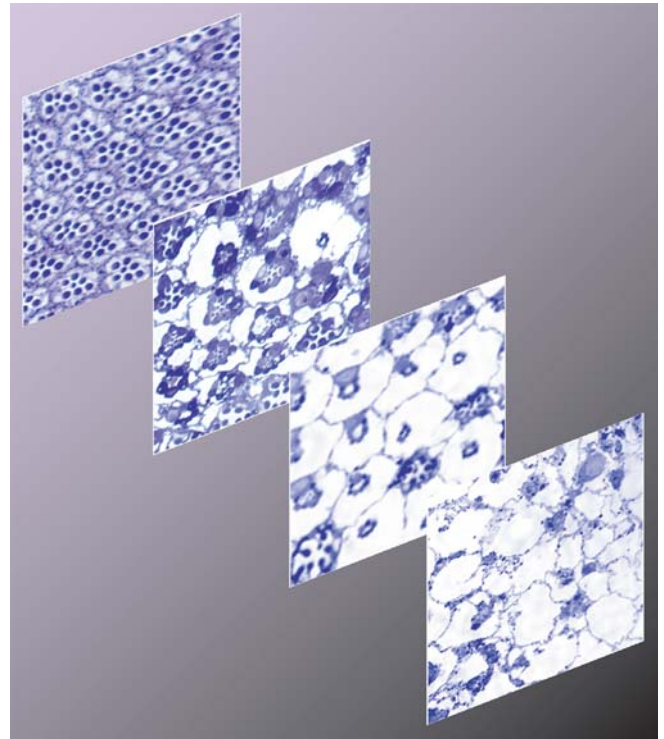

DOI: 10.1371/journal.pbio.0040438.g001

***Drosophila* photoreceptors that lack NMNAT degenerate very rapidly, as seen in this retina cross section that shows progressive degeneration from wild-type (in the back) to 28-day-old retina (in the front).**

the idea that NMNAT protects against degeneration, as do studies in which NMNAT was overexpressed in *Drosophila*. But mice in which NMNAT is overexpressed show no protection.

The authors used a screening system that allowed them to look for flies that are homozygous for mutations—meaning that both copies of a gene are mutated—that result in death in cells of the visual system but are heterozygous, with one normal copy and one mutated copy, in the rest of the body. This means that mutations that would normally be lethal can be investigated in living flies. To look for mutations that affect synaptic function or development, the authors screened mutated *Drosophila* for abnormalities in phototaxis (a test of vision in which the organism moves toward or away from light; normal flies move toward light). They then tested the visual responses of the identified flies and looked for abnormal synapse structure in the eyes. This screening process identified two “nonsense” mutations in the gene for *Drosophila* NMNAT that prevents the gene from generating the correct protein.

When they characterized the protein, the authors found that it was highly homologous to NMNAT proteins in humans and mice. Staining with an antibody against NMNAT showed that the protein is highly enriched in the fly nervous system, mainly in the cell nuclei and nerve terminals. Flies carrying the NMNAT mutation had abnormal photoreceptors that became progressively damaged with age, indicating a degenerative process. Mutant photoreceptors appeared to develop normally but did not survive. NMNAT therefore seems to be required for the maintenance of mature neurons.

What is the mechanism of degeneration in *nmnat* mutant photoreceptors? When mutant flies were raised in the dark, their degeneration was much less severe than when

they were raised in the light, indicating that photoreceptor activity contributes to the degenerative process. Flies with double mutations that lacked both NMNAT and functioning photoreceptors also showed reduced neurodegeneration. This led the authors to conclude that the normal function of NMNAT is to protect photoreceptors against light-induced degeneration. They also showed that overexpression of NMNAT could protect photoreceptors against the degeneration caused by excessive activity in flies with mutations that cause continuous activation of photoreceptors.

To investigate the importance of NAD synthesis in neuroprotection by NMNAT, the authors generated an enzymatically inactive form of NMNAT. To their surprise, they found that expression of this protein could prevent neurodegeneration in *nmnat* mutants. However, this inactive NMNAT could not stop a full, homozygous *nmnat* mutation from being lethal to flies. These results indicate that NMNAT has two functions: its NAD synthase activity is essential for survival, but another activity is responsible for neuroprotection.

This study sheds new light on the mechanisms of neural degeneration and the functions of NMNAT. Attention will now turn to the identification of its second, non-NAD-dependent activity, as well as to continued attempts to reconcile the apparently conflicting results of earlier overexpression experiments.

Zhai RG, Cao Y, Hiesinger PR, Zhou Y, Mehta SQ, et al. (2006) How *Drosophila* NMNAT maintains neural integrity independent of its NAD synthesis activity. DOI: 10.1371/journal.pbio.0040416

In the Gut's Microbial Community, One Plus One Equals Many (Effects)

Richard Robinson | DOI: 10.1371/journal.pbio.0040447

The instructions for assembling an adult human being include adding ten parts microbial cells to one part human cells. The parts list on the microbial side have likely changed as our diets, lifestyles, and biosphere have undergone significant changes. Reports are appearing that show that our microbial partners' genomes (the human microbiome) encode physiologic capacities that complement our own deficiencies. For example, the microbiome gives rise to a large assemblage of microbial enzymes not found in humans that break down and extract calories from food we ingest and inactivate potentially toxic compounds that we consume. This leads to a sobering thought: that technological advances aimed at reducing food spoilage and our contact with environmental microbes have instead compromised the services of our microbial partners and made us more vulnerable to certain maladies, including digestive disorders.

Against this background, a class of microbes, most derived from fermented dairy products, have been promoted as benefiting human health if consumed on a regular basis. They bear the moniker “probiotics” and may be able to restore features lost during the hypothesized sanitization of our 21st century microbiota. But a chorus of skeptical inquirers wonder how, and whether, probiotics work. Do they alter the properties of our incredibly complex community of gut microbes? Can a few billion influence many trillions? Do they communicate directly with their host, or do they require



DOI: 10.1371/journal.pbio.0040447.g001

Probiotics are widely used preparations of live bacteria intended to improve human health. Methods are now in hand to begin to define their impact on the human gut microbiota and their host. (Image: Justin Sonnenburg, Jamie Dant, Laura Kyro, and Jeffrey Gordon)

a microbial brigade to translate their effects? If so, what precisely are the effects on our biology, and do these effects occur in all individuals?

Justin Sonnenburg, Christina Chen, and Jeffrey Gordon address these questions in a new study by turning to a simplified model of the human gut. Their starting point was a collection of germ-free mice who had spent their entire lives

in sterile plastic bubbles munching on microbe-free chow and water. Sonnenburg et al. then introduced a prominent member of the normal human gut community (the almost unpronounceable *Bacteroides thetaioatomicron*) with or without *Bifidobacterium longum*—a minor resident of the community and a probiotic. Using a custom “community” GeneChip to monitor gene expression in the two bacterial species, another GeneChip to monitor the gene expression in the host gut, plus mass spectrometry, they show how each organism affects the other as well as the mouse cells that line the gut.

B. thetaioatomicron expands its capacity to consume a broad range of otherwise indigestible polysaccharides when it co-exists with *B. longum*; this involves preferential use of dietary plant glycans over host mucus glycans. *B. longum* does not expand its dining habits, but rather shifts away from one class of polysaccharides that its microbial neighbor is using (mannosides), and turns its attention toward another (xylosides). Similar to cohabitation with *B. longum*, another fermented dairy product-associated species, *Lactobacillus casei*, induces expansion of *B. thetaioatomicron*'s polysaccharide digestive capabilities, but *B. longum*'s close

relative *Bifidobacterium animalis* does not. These responses, documented in a highly defined and controlled system, offer a first glimpse at how microbes respond to one another in the gut and emphasize that not all probiotic species affect the microbiota in the same manner. The host acknowledges when *B. thetaioatomicron* and *B. longum* are present together by mobilizing the expression of suites of genes, including those involved in modulating the activity of the immune system.

The approaches described in this study should be generally useful for defining ways that we and our modern microbiota may be affected by probiotics and for developing a knowledge base that can be applied to humans in well-controlled clinical trials. Ultimately, the goal is to develop rational ways to optimize the performance of our microbial partners so that our health as a “superorganism” can be improved. For more on probiotics, see the Primer in the December issue; DOI: 10.1371/journal.pbio.0040430.

Sonnenburg JL, Chen CTL, Gordon JI (2006) Genomic and metabolic studies of the impact of probiotics on a model gut symbiont and host. DOI: 10.1371/journal.pbio.0040413

Shedding Light on Local Organizational Principles in the Primary Sensory Cortex

Jami Milton Dantzer | DOI: 10.1371/journal.pbio.0040420

Humans see the world in rich color and detail. Rodents supplement their vision with long whiskers that provide tactile information about their environment. Neuroscientists can investigate how these senses are represented in the brain by identifying general organizational principles of the underlying neural circuits; different parts of the body surface have been mapped to specific brain areas. However, the resolution of this topographical brain map is coarse. It is analogous to a world map that shows the highways connecting major cities, but without details about local streets in each region. Tapping into the finer details of local information flow is a daunting task, because each cubic centimeter of the brain contains millions of neurons connected by billions of synapses.

Now, Ingrid Bureau, Karel Svoboda, and colleagues have shed light on the complexities of brain form at high resolution, revealing what may be a general principle by which sensory information enters and segregates in the primary sensory areas of the cerebral cortex. Sensory information is known to relay through a midbrain structure called the thalamus before entering the cerebral cortex. In the visual system, distinct types of properties about objects in a visual scene—such as motion or object texture—travel in separate pathways through the thalamus. This segregation of object information is maintained in the local circuits of the primary visual cortex (the first cortical area that processes visual information) and continues to remain relatively segregated in higher visual cortical areas. Bureau et al. show that in the whisker system of rodents, the flow of object touch and motion-related information transduced by whisker stimulation bears a striking similarity to the visual system. The distinct types of information remain segregated when entering the barrel cortex (the first cortical area that processes whisker information), and this segregation is maintained as the excitation ascends within the barrel cortex.

To unlock the secrets of local brain organization in the mouse barrel cortex, the authors used a technique termed laser scanning photostimulation (LSPS) that produces a

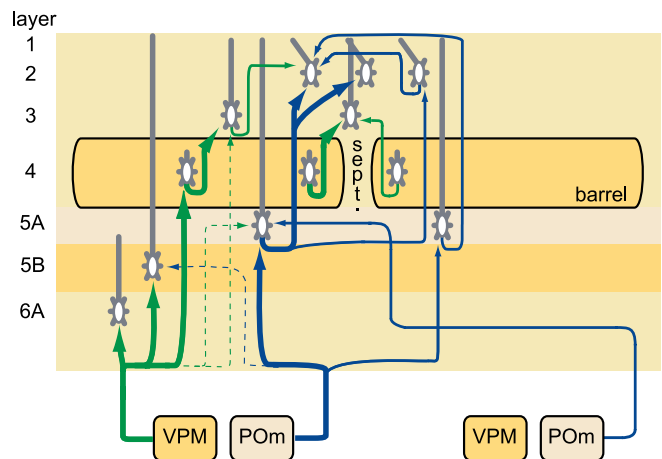

DOI: 10.1371/journal.pbio.0040420.g001

Circuit diagram of the thalamocortical and ascending intracortical projections in the barrel cortex. (Lemniscal projections, green; paralemniscal projections, blue.) Thick, thin, and dashed lines denote decreasing density of the projection.

fine-scale quantitative spatial map of functional connectivity. Neurons in the cortex are known to communicate via chemical synaptic contacts, and LSPS produces a spatial map of neurons that form functional synaptic contacts with one another. The authors performed LSPS in “thalamocortical” brain slices that preserved both the connections from the thalamus into the barrel cortex and the local connections between the eight laminar subdivisions of the barrel cortex (layers 1, 2, 3, 4, 5A, 5B, 6A, and 6B). For whisker information, the thalamus functionally segregates between two main pathways: the paralemniscal pathway, which travels anatomically through the posterior nucleus (POm) of the thalamus and conveys sensor motion (“whisking”) signals, and the lemniscal pathway, which travels through the ventral posteromedial nucleus (VPM) and conveys contact (“touch”) signals and whisking signals.

Bureau et al. mapped connections from the lemniscal touch and paralemniscal whisking pathway into the barrel cortex and saw that these pathways connect into distinct layers in the barrel cortex. The lemniscal pathway makes direct connections primarily in three layers (layers 4, 5B, and 6), while the paralemniscal connects primarily in just one (layer 5A). Remarkably, layer 2/3 received little direct thalamic input from either pathway, a result that wasn't easily predicted from simply following anatomical connections from the thalamus to the barrel cortex. However, when they continued to follow these pathways through the local circuits of the cortex, the authors saw that lemniscal layer 4 strongly targeted layer 3, and in contrast, paralemniscal layer 5A strongly targeted layer 2, with some diffuse connectivity in layer 3.

These findings reveal an unprecedented level of local functional organization and show for the first time that distinct types of information gathered by whisker stimulation about surrounding objects remain segregated both in the thalamus and in the barrel cortex. Future work will determine how these local pathways organize globally throughout higher cortical areas. Most importantly, with a better understanding of local and global organizational patterns in sensory areas, neuroscientists are one step closer to translating brain form into its exquisite function of accurately representing the world.

Bureau I, von Saint Paul F, Svoboda K (2006) Interdigitated paralemniscal and lemniscal pathways in the mouse barrel cortex. DOI: 10.1371/journal.pbio.0040382

RNA Silencing Sheds Light on the RNA World

Rachel Jones | DOI: 10.1371/journal.pbio.0040448

RNA silencing — also known as RNA interference — is an intriguing phenomenon in which short, double-stranded RNA “triggers” can prevent the expression of specific genes. First discovered in plants, RNA interference is now recognized as a widespread, if not ubiquitous, phenomenon, and it is causing great excitement as an experimental technique for selectively blocking gene expression.

The mechanisms of RNA silencing have been intensively studied. One important step is the formation of single-stranded RNA pieces (called siRNAs) from the double-stranded triggers. In “lower” organisms—including plants, protozoa, fungi, and nematode worms—it also involves an enzyme—called RNA-dependent RNA polymerase—that can generate a strand of RNA using existing RNA as a template. This means that it can create double-stranded RNA from single-stranded pieces of RNA. By doing this, it generates more triggers and so amplifies the effect of RNA silencing. Paula Salgado and her colleagues have studied the structure of one such polymerase, called QDE-1, and found that it provides clues to the earliest stages of evolution.

When a gene is transcribed and translated to generate a protein, the process begins with a DNA-dependent RNA polymerase. Like QDE-1, DNA-dependent RNA polymerases generate strands of RNA—the difference is that they use a DNA template to do it. The RNA they generate is called messenger RNA and is in turn used as the template for building a protein out of amino acids. The structures of DNA-



DOI: 10.1371/journal.pbio.0040448.g001

Schematic showing the fold of the QDE-1 RNA interference polymerase. The dimeric molecule is shown with the polypeptide chains colored from blue at the N termini to red at the C termini.

dependent RNA polymerases have been described previously, so that the authors of this study could compare them with their new structure of QDE-1.

What they found was a remarkable similarity. Both DNA-dependent RNA polymerases and QDE-1 have an active catalytic site—the working core of the enzyme—that is formed by two distinctive structural domains called double-psi β -barrels. This strong structural resemblance between QDE-1 and the DNA-dependent RNA polymerases points towards an evolutionary link between the two types of RNA polymerase.

An influential theory on the origin of life proposes that RNA molecules were the first self-replicating molecules, forming a kind of precellular life in an “RNA world.” Initially, RNA molecules would have had to act as enzymes as well as genetic information so that they could replicate, but it is likely that an RNA-dependent RNA polymerase

would have been one of the earliest protein-based enzymes to evolve.

The similarity between QDE-1 and the DNA-dependent RNA polymerases suggests that both evolved from one ancestor, because otherwise, the resemblance between their active sites would be highly unlikely. This common ancestor might have been a primordial RNA polymerase in an RNA world.

The authors suggest that this ancestor would have had just one double-psi β -barrel, and that gene duplication led to an enzyme with two barrels. From this early polymerase evolved both QDE-1-like RNA-dependent RNA polymerases and a diverse array of specialized DNA-dependent RNA polymerases. The diversification of DNA-dependent RNA polymerases would have been facilitated by the splitting of the two double-psi β -barrels onto separate subunits, rather than being borne on the same subunit as in QDE-1, so that different subunits could combine to create specialized polymerases.

These findings provide a link between RNA silencing and the earliest mechanisms of RNA transcription—perhaps shedding light on both the origins of RNA replication (and therefore life) and the evolution of RNA silencing. They also provide insights into the mechanism of action of QDE-1 that might apply across the board to RNA-dependent RNA polymerases, and that will be built upon by further work.

Salgado PS, Koivunen MRL, Makeyev EV, Bamford DH, Stuart DI, et al. (2006) The structure of an RNAi polymerase links RNA silencing and transcription. DOI: 10.1371/journal.pbio.0040434