

## THE OFFSET OF MORPHINE TOLERANCE IN RATS AND MICE

B.M. COX, M. GINSBURG & JULIA WILLIS,  
with an Appendix by J.K. DAVIES

Basic Medical Sciences Group, Department of Pharmacology, Chelsea College, Manresa Road, London SW3 6LX

1 In rats and mice made tolerant to morphine by pretreatment with the drug, the shift to the right of the log dose/analgesic response line for morphine from its position in naive animals occurs without significant change in slope provided that sufficient time is allowed for elimination of pretreatment drug.

2 Responsiveness to the analgesic effects of morphine, given together with cycloheximide to prevent reinforcement of tolerance, was measured in rats (paw pressure method) and mice (hot plate method) at intervals during 1-23 days following cessation of a variety of regimens of tolerance-inducing drug treatments.

3 A biphasic pattern of recovery of responsiveness was observed, which was independent of the regimen or the drug (morphine, methadone or diamorphine) used to induce tolerance. Estimates of the rates of the first, fast phase are imprecise but the rate of the second phase of offset, from 4th day after cessation of pretreatment had, in rats, a mean half-time of  $13.2 \pm 0.53$  days—for all pretreatments combined, there being no significant differences between the various pretreatment regimens employed. In mice, similarly, a biphasic recovery of analgesic responsiveness was seen after morphine pretreatment, the mean half-time of the slower phase being 17.4 days.

4 Precipitation of an acute withdrawal syndrome in rats by naloxone HCl given 6 h after the final injection of a tolerance-inducing treatment with morphine did not affect the subsequent rate of recovery from tolerance.

5 During the period following a tolerance-inducing pretreatment with morphine in mice, the rate of attenuation of the naloxone-evoked jumping response was faster than the rate of offset of tolerance.

### Introduction

Opioid narcotic drugs produce numerous effects on neuronal function in the central nervous system, and it has proved difficult to identify separately those processes concerned in the mediation of particular opioid agonist actions or those involved in the genesis of tolerance and dependence. Identification of the mechanisms responsible for the phenomenon of tolerance may be assisted by knowledge of the rate of recovery from the tolerant state, because it seems likely that the rate of reversion towards the level of responsiveness to morphine seen in naive animals reflects the recovery from the underlying metabolic perturbation.

Reports on the rate of offset of opioid tolerance are sparse and conflicting; Cochin & Kornetsky (1964) report that in rats significant tolerance to morphine was retained for more than one year following single or multiple doses of morphine, whereas Goldstein & Sheehan (1969)

estimated the time of recovery from levorphanol tolerance in mice to be 'essentially the same, within the limits of experimental error, as the rate of onset of tolerance,' (that is, in their experiments, a half-time of 16-48 hours).

We have, therefore, reassessed the rate of recovery from tolerance to the analgesic effects of morphine in both rats and mice. A difficulty in measuring the level of morphine tolerance arises from the fact that the test procedure necessarily involves the administration of an opioid analgesic which then reinforces the phenomenon being measured. This problem has been circumvented in the present experiments by the simultaneous administration of a protein synthesis inhibitor with the test dose of opioid drug, a procedure which prevents the further development of tolerance whilst not affecting previously established tolerance (Cox, Ginsburg & Osman, 1968; Cox & Osman, 1970). A preliminary

account of this work has been presented to a meeting of the British Pharmacological Society (Cox, Ginsburg & Willis, 1973).

## Methods

### *Induction of opioid drug tolerance*

All drugs were dissolved in 0.9% w/v NaCl solution (saline), and were given s.c. to both rats and mice, except for methadone which was given i.p. because when given s.c. it causes, in some animals, skin lesions at the site of injection. Injections were given twice daily, at 09 h 00 min and 17 h 00 min; on the starting day the first injection was given at 17 h 00 min and on the concluding day the final injection was given at 09 h 00 min. Control animals were given twice daily injections of saline simulating the regimens of drug administration which were as indicated in Table 1.

### *Assessment of analgesic responsiveness*

Analgesic responsiveness was tested in rats by a pressure method during continuous intravenous infusion of morphine HCl with cycloheximide via an exteriorized cannula inserted under ether anaesthesia in an external jugular vein at least 18 h before the beginning of the infusion (Cox, *et al.*, 1968). The flow rate of the infusion was 0.5 ml/h and the infusate (in saline) contained cycloheximide such that each rat received  $200 \mu\text{g kg}^{-1} \text{h}^{-1}$ . In most experiments the rate of concomitant morphine HCl infusion was  $5 \text{ mg/kg}^{-1} \text{h}^{-1}$ .

Analgesia was assessed in rats by estimation, at intervals during an infusion, of responsiveness to a painful stimulus using an Analgesimeter (Ugo Basile, Milano) to measure the minimum load that must be applied to a rat's hind paw to cause the animal to react, see Randall & Selitto (1957).

In mice, analgesia was measured by a modification of the hot-plate method described by Woolfe & McDonald (1944); the surface temperature of the plate was  $55^\circ\text{C}$ . The response time to elicit the reaction (licking or blowing on the front paws, kicking the hind feet or hopping on all feet or jumping) was noted before and 30 min after a s.c. injection of morphine HCl (12 mg/kg) plus cycloheximide (20 mg/kg). Mice that did not react within 30 s were removed from the hot-plate to avoid damaging their paws. In fact, all mice responded within that time.

### *Assessment of morphine dependence in mice*

The rate of spontaneous jumping or 'escape jumping' in mice is increased after an injection

Table 1 Pretreatments for induction of morphine tolerance in rats.

Day	Hour	1	2	3	4	5	6	7	
		17.00	09.00	17.00	09.00	17.00	09.00	17.00	09.00
Morphine A		10	10	20	20	20	40	40	40
Morphine B		10	10	20	20	20	40	40	40
Morphine C		10	10	20	40	40	60	80	100
Morphine D		20	20	40	80	80	120	160	200
Methadone		10	10	10	12.5	12.5	12.5	12.5	200
Diamorphine		5	5	10	15	15	20	20	200

Doses refer to mg/kg of hydrochloride of each drug. Morphine and diamorphine were given s.c.; methadone was given i.p.

with naloxone (10 mg/kg i.p.) following pretreatment with morphine and is often taken as a measure of dependence (Way, Loh & Shen, 1969; Cheney & Goldstein, 1971). The jumping rate was counted using the apparatus (Figure 8) described in the Appendix.

## Results

### *Relationship of morphine dosage to analgesic response in naive and tolerant animals*

Groups of 6 rats were given an intravenous infusion of morphine at 1, 2, 3, 4 and 5 mg kg<sup>-1</sup> h<sup>-1</sup>. Cycloheximide was infused concurrently with the morphine HCl at a rate of 200 µg kg<sup>-1</sup> h<sup>-1</sup> to prevent the development of tolerance to the morphine during the course of infusion (Cox & Osman, 1970), and the nociceptive responsiveness for each rat was assessed by determination of the pressure threshold at 60 or 90 min intervals after the start of the infusion. At each infusion rate, the mean analgesic index rose during the first 2-3 h to reach a plateau level which was maintained to the end of the infusion (Figure 1). Similar experiments were carried out in groups of rats which had been rendered tolerant to the analgesic effects of morphine by pretreatment with the drug; these test infusions were administered 2 days or 7 days after cessation of pretreatment. The mean analgesic indices again reached a plateau after about 3 h of the infusion as with the naive animals but, naturally, greater amounts of morphine were required to produce analgesic effects of comparable magnitude. The steady state analgesic indices were plotted against the morphine infusion rates (on a logarithmic scale). The straight line fitting the points obtained in these experiments, with animals 7 days after cessation of the tolerance-inducing treatment, paralleled that for naive animals and was shifted to the right (Figure 2a). However, 2 days after the end of the pretreatment period the more marked shift to the right was accompanied by significant flattening of the log-dose response line.

Log-dose response curves were also determined in naive mice and mice 2 days after a period of 7 days treatment with morphine HCl (dosage schedule D, Table 1). Analgesic responsiveness was tested by the hot plate method. Single subcutaneous doses of morphine HCl were given and the analgesic response was measured 30 min later. There was no significant deviation from parallelism of the log-dose response curves for naive and tolerant animals (Figure 2b).

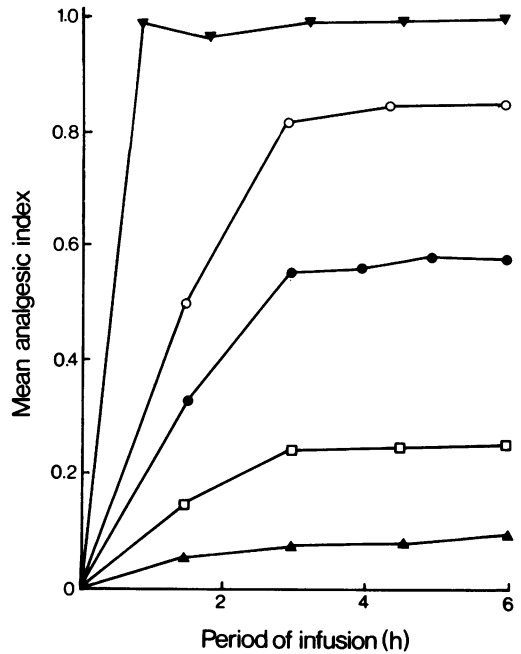
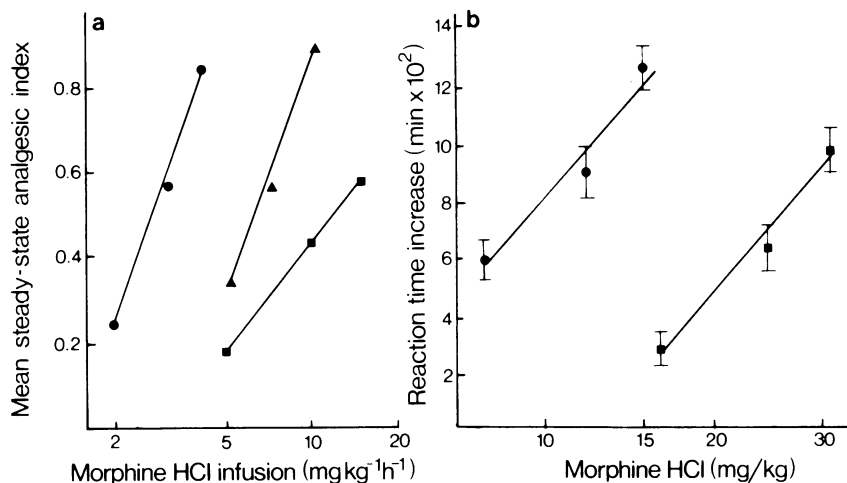

**Figure 1** Time course of analgesic responses to different doses of morphine plus cycloheximide (200 µg kg<sup>-1</sup> h<sup>-1</sup>), infused intravenously for 6 h into conscious rats. Mean analgesic index was estimated from 4-6 rats. In this and subsequent figures s.e. mean are not shown where they are ≤ symbol signs. (▲) 1 mg kg<sup>-1</sup> h<sup>-1</sup> morphine HCl; (□) 2 mg kg<sup>-1</sup> h<sup>-1</sup> morphine HCl; (●) 3 mg kg<sup>-1</sup> h<sup>-1</sup> morphine HCl; (○) 4 mg kg<sup>-1</sup> h<sup>-1</sup> morphine HCl; (▲) 5 mg kg<sup>-1</sup> h<sup>-1</sup> morphine HCl.

### *Recovery of the analgesic response to morphine after the development of tolerance*

*Recovery following morphine pretreatment in rats.* The offset of morphine tolerance was studied by measuring the analgesic response to a standard infusion of morphine, at various time intervals after cessation of the tolerance-inducing treatments. The choice of this approach, rather than the more expensive, arduous, and time consuming procedure of determining for each stage the dose of morphine that would elicit a standard analgesic effect, was justified in the light of the results described above, showing that the reduced responsiveness of tolerant animals could be described by a parallel shift to the right from the dose-response curve for morphine in naive animals.

On selected days after the termination of a period of morphine pretreatment, rats in separate groups of between 4 and 6 were given intravenous



**Figure 2** Log dose-response plots for morphine in naive and tolerant rats and mice. (a) In rats given morphine pretreatment C and tested for morphine responsiveness by a paw pressure method during continuous intravenous infusion of morphine plus a fixed dose of cycloheximide ( $200 \mu\text{g kg}^{-1} \text{h}^{-1}$ ). (b) In mice given morphine pretreatment D and tested for morphine responsiveness by the hot-plate method, 30 min after s.c. injection of morphine HCl. (●) naive animals; (■) 2 days after cessation of pretreatment; (▲) 7 days after cessation of pretreatment.

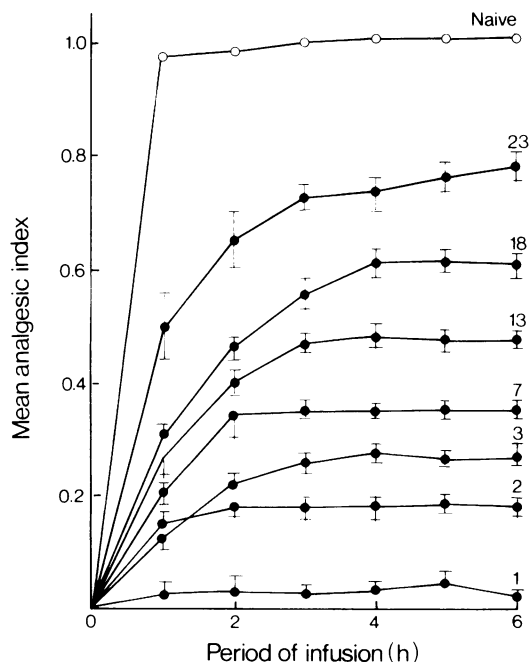
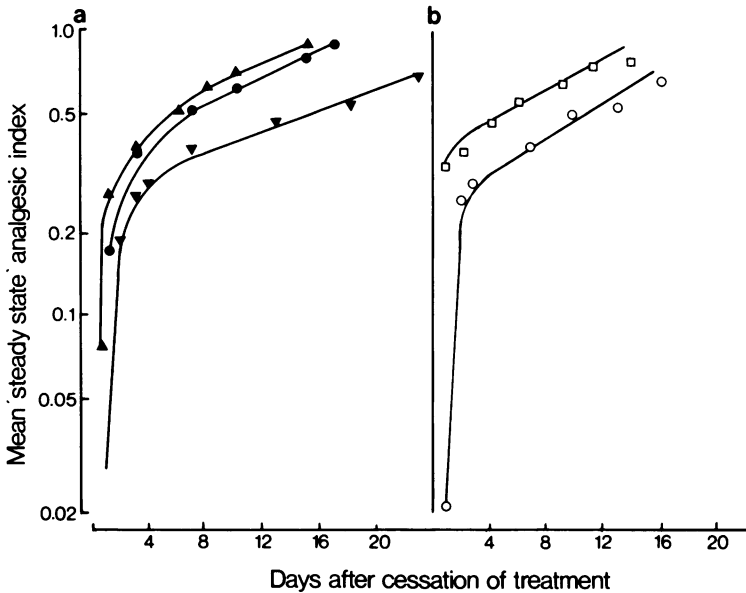

**Figure 3** Antinociceptive responses during intravenous infusion of morphine HCl ( $5 \text{ mg kg}^{-1} \text{h}^{-1}$ ) plus cycloheximide ( $200 \mu\text{g kg}^{-1} \text{h}^{-1}$ ) in rats during recovery from morphine tolerance (pretreatment C). Numbers on curves refer to the number of days after cessation of the pretreatment. Mean analgesic index was estimated from 4-6 rats. Vertical bars indicate s.e. mean. (○) results from naive rats which received saline only in the pretreatment period.

infusions of morphine HCl ( $5 \text{ mg kg}^{-1} \text{h}^{-1}$ ) together with cycloheximide ( $200 \mu\text{g kg}^{-1} \text{h}^{-1}$ ); pressure thresholds were determined at intervals during the infusion (Figure 3).

During each infusion the mean analgesic index value increased for the first 2-3 h when a steady state level was reached which was maintained for the rest of the infusion period. The steady state analgesic index increased progressively as the interval between the pretreatment and the final dose of the pretreatment. A plot of the steady state analgesic index value (on a logarithmic scale) against the days after termination of morphine pretreatment showed that the recovery of sensitivity to morphine occurred in two phases; an initial rapid phase of recovery followed by a slower phase (Figure 4a). Similar results were obtained for the three different regimens of morphine pretreatment, which were chosen to induce initial tolerances of varying intensity.

From the point of inflection on the curve (at about the fourth day) until offset of tolerance was virtually complete (up to 23 days) the points were well-fitted by straight lines, the slopes of which were similar for all tolerance-inducing treatments. The mean slopes during this phase correspond to a half-time for recovery of morphine sensitivity of  $13.2 \pm 0.53$  days. No estimates of the rate of recovery during the initial rapid phase have been made because of low precision in the determination of the analgesic indices at the low values obtained in highly tolerant animals and because the testing procedure itself occupies a period of

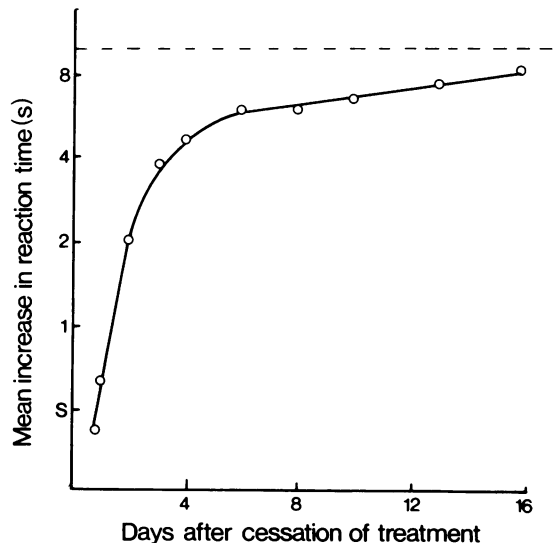

**Figure 4** Rate of recovery of responsiveness to morphine HCl ( $5 \text{ mg/kg}^{-1} \text{ h}^{-1}$ ) infused intravenously with cycloheximide ( $200 \text{ } \mu\text{g/kg}^{-1} \text{ h}^{-1}$ ) in rats rendered tolerant to morphine by different pretreatments. Mean 'steady state, analgesic index was estimated from 4-6 rats. (a) (▲) morphine pretreatment A; (●) morphine pretreatment B; (▼) morphine pretreatment C; (b) (◻) methadone pretreatment; (○) diamorphine pretreatment.

time that is significant in relation to the recovery rate.

*Recovery following methadone or diamorphine pretreatment in rats.* Measurements of the recovery of sensitivity to morphine after pretreatment of rats with methadone or diamorphine showed that the analgesic response returned in a similar biphasic manner following tolerance induction with these drugs (Figure 4b). From the fourth day onwards the points are fitted by straight lines whose slopes correspond to half-times for recovery of 14.2 and 11.4 days for methadone and diamorphine respectively.

*Recovery following morphine pretreatment in mice.* At predetermined time intervals after the completion of the tolerance induction in mice, the response, to a s.c. injection of the standard dose of morphine HCl ( $12 \text{ mg/kg}$ ) plus cycloheximide ( $20 \text{ mg/kg}$ ), was tested by measuring the increase in reaction time on the hot plate; different groups of animals were used at each time of testing. When the responses were plotted on a logarithmic scale against the time after the final morphine dose, it was seen that once again recovery occurred in two phases. In mice the half-time for the second phase was estimated to be 17.4 days (Figure 5). The possibility that the protein synthesis inhibitor



**Figure 5** Rate of recovery of responsiveness to morphine in tolerant mice. Reaction time was estimated 30 min after a s.c. injection of morphine HCl ( $12 \text{ mg/kg}$ ) plus cycloheximide ( $20 \text{ mg/kg}$ ) in tolerant mice (observations in 16-25 animals). The horizontal broken line indicates the mean increase in reaction time in naive mice.

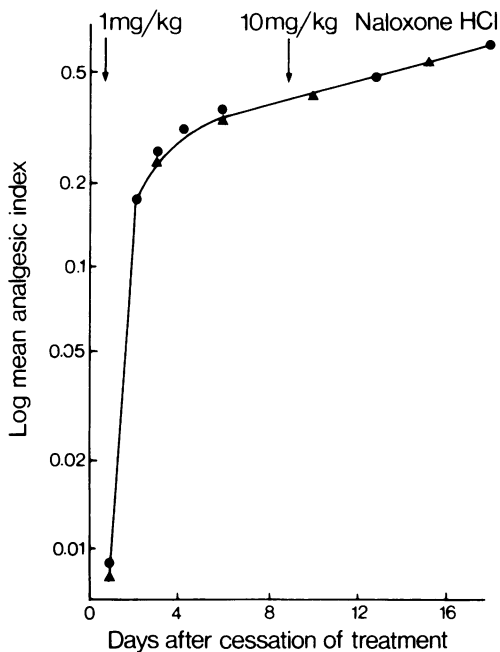

**Figure 6** Lack of effect on recovery from morphine tolerance in rats of naloxone given 6 h and 9 days after the cessation of pretreatment C. Mean 'steady state' analgesic index was estimated from 4-6 animals. (▲) naloxone treated; (●) untreated with naloxone.

alone might affect recovery was tested by giving one group of eight mice, cycloheximide (20 mg/kg s.c.) on the ninth day of recovery. The increase in reaction time produced by morphine and cycloheximide in these animals on the following day was not different from that in a control group of mice.

*Effects of naloxone on recovery from morphine pretreatment in rats.* It has been suggested that morphine antagonists such as nalorphine or naloxone interact competitively with morphine at a common receptor site (Cox & Weinstock, 1964; Grumbach & Chernov, 1965; Pert & Snyder, 1973) and that displacement of morphine from binding sites might be responsible for the rapid onset of withdrawal symptoms induced by these drugs in morphine-dependent animals (Goldstein, Aronow & Kalman, 1969). It was therefore of interest to investigate the effects of naloxone treatment on the recovery of sensitivity to morphine. A group of rats tolerant to morphine (pretreatment C, Table 1) received a dose of naloxone HCl (1 mg/kg s.c.) 6 h after the last morphine dose. This dose was sufficient to precipitate withdrawal symptoms namely diarrhoea, irritability, ptosis, headshakes,

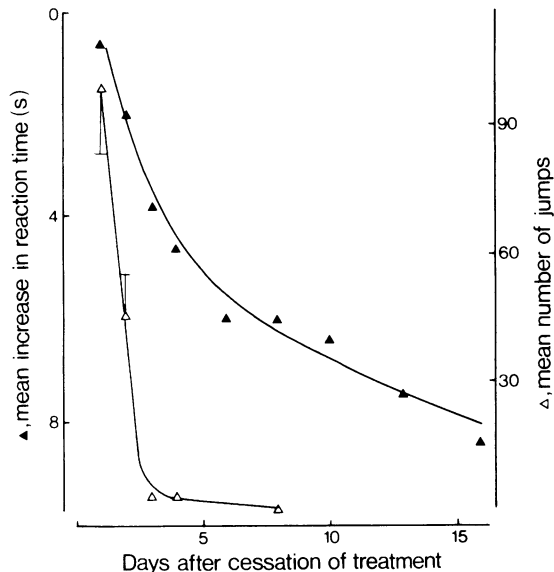

**Figure 7** Comparison of offset of morphine tolerance and naloxone-elicited jumping in mice. Increase in hot plate reaction time was estimated 30 min after s.c. injection of morphine HCl (12 mg/kg) plus cycloheximide (20 mg/kg). Mean number of jumps per mouse was determined during a 20 min period after i.p. injection of naloxone HCl (10 mg/kg; observations in 16-25 mice). The intersection of the abscissa and the left-hand ordinate gives the mean increase in hot plate reaction time in naive mice.

body trembling, etc., symptoms which were more intense and more acute than those observed following simple withdrawal of the drug. Different subgroups of these animals were then given the standard morphine and cycloheximide infusion on subsequent days and the steady state analgesic indices determined. Animals not tested for morphine responsiveness before day 9 of recovery received an additional dose of naloxone HCl (10 mg/kg s.c.); the second naloxone dose did not elicit any observable withdrawal symptoms.

The responses of the naloxone-treated rats were compared with those of a control group which received an identical morphine pretreatment but did not receive naloxone. The results (Figure 6) showed that naloxone administration did not affect the recovery of the analgesic response to morphine.

#### *Rate of loss of naloxone sensitivity in mice*

Of the techniques available for assessing the degree of physical dependence in opioid-treated small

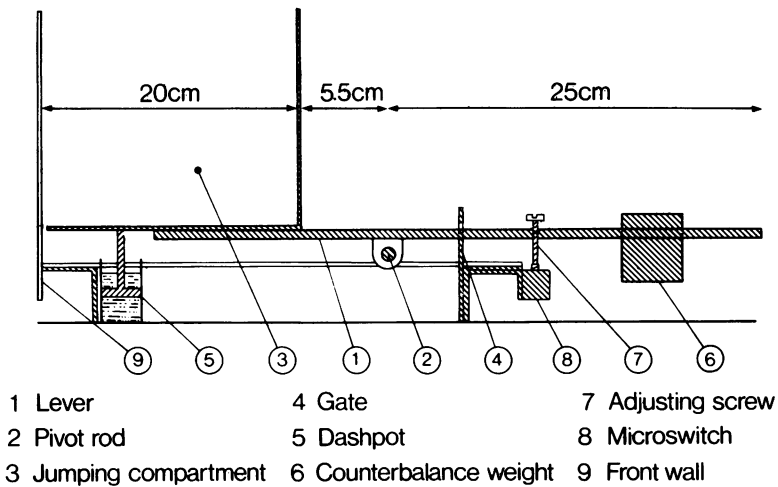

Figure 8 Counter for recording mouse jumping activity.

laboratory animals, the procedure which most readily yields quantitative data is the measurement of the incidence of the characteristic jumping (escape) response elicited by naloxone in dependent mice (Marshall & Weinstock, 1969; Cheney & Goldstein, 1971).

Experiments to compare the rate of loss of naloxone sensitivity with the rate of recovery of the analgesic response to morphine were carried out at various times after the cessation of pretreatment D (Table 1). On each day the tests for responsiveness to the antinociceptive effects of morphine HCl (12 mg/kg) given subcutaneously with cycloheximide (20 mg/kg) were followed 4-5 h later by an injection of naloxone HCl (10 mg/kg *i.p.*) and determination of the jumping activity over the ensuing 20 minutes.

Figure 7 shows, plotted on arithmetic scale, the loss of the naloxone response and the loss of tolerance to the antinociceptive effect of morphine as time elapses following the final dose of the morphine pretreatment, the former being expressed as the mean number of naloxone-elicited jumps per mouse and the latter in the increase in hot plate reaction time induced by morphine. Naloxone sensitivity declined much more rapidly than tolerance. Thus on day 8, no jumps could be elicited by the naloxone treatment although the mice were still clearly tolerant to the analgesic effect of morphine.

## Discussion

The rate of offset of morphine tolerance may be obtained by estimating at time intervals after

cessation of pretreatment with morphine either, the recovery of the response to a fixed dose of morphine or the dose of drug required to elicit an arbitrarily defined standard response. For the present experiments the former strategy was adopted because it is more economical in time and in resources.

In general a pattern of change in one of these parameters will be reflected in the other provided that alteration in the position of the log dose-response curve is not accompanied by alteration of slope. This has been shown to be the case in the comparison of naive mice with mice two days after morphine withdrawal and in the contrast of naive rats with rats 7 days after morphine withdrawal. However, slight flattening of the log dose-response curve was observed after 2 days abstinence in rats, an effect which could be predicted on pharmacokinetic grounds from the persistence of some of the morphine from the tolerance-inducing treatment. Thus any discrepancy arising from this source would affect estimates of the recovery rate only in the period immediately following cessation of pretreatment, a period in which, for other reasons given in Results, no attempt was made to reach a precise estimate of recovery rate.

It should be remembered that owing to a restriction imposed by the experimental design (arising from avoidance of injurious nociceptive stimuli), all the analgesic responses probably lie in the lower half of a complete log dose-response curve. Nevertheless, the smallest analgesic response considered by us to be significant was represented by points on the straight line portion of the curve.

In both rats and mice the return of the analgesic response to the standard morphine

treatment occurred in two phases. There was an initial rapid recovery which was complete in 3-4 days, followed by a slower phase. The half-time for this slower recovery phase ( $T_{1/2}$  13.2 days in rats, 17.4 days in mice) was independent of the intensity or means of the tolerance induction. These results differ from those reported by Goldstein & Sheehan (1969) on recovery from tolerance to the 'running-fit' caused by levorphanol in mice. They found that recovery occurred as a single phase, with a half-time of 16 h when tolerance-inducing doses of levorphanol were given at 8 h intervals, or with half-time of 48 h when the tolerance-inducing doses were given at 16 h intervals. Goldstein & Sheehan suggest that their results are consistent with the proposition that the opioid drug induces a change in the synthesis rate of an enzyme of functional protein maintained at steady state level by end-product control of the synthesis rate and an exponential rate of breakdown, although it is not clear why the recovery half-time should vary with the frequency of administration of the tolerance-inducing drug.

Our results on the recovery of the analgesic response are not consistent with this explanation since the half-time of slower recovery phase is considerably longer than the half-time for tolerance development (e.g. consider morphine pretreatment A which lasted for 3 days only). Recovery times greatly in excess of these have been described by Cochin & Kornetsky (1964) who reported that the analgesic response to morphine in rats still had not returned to normal 14 months after a single prior application of morphine (20 mg/kg). We cannot explain the discrepancy between their results and the progressive return over a period of 20-30 days to the sensitivity of naive animals, as described in this paper.

The contrast between the single phase rapid recovery of the 'running fit' response (Goldstein & Sheehan, 1969) and the more prolonged biphasic recovery of the analgesic response suggests that different processes are concerned in tolerance development with regard to these two opioid drug effects, or that a similar mechanism with a rapid recovery time is involved in tolerance to both effects but that an additional process with a slower recovery time is also involved in tolerance to the analgesic response.

The close agreement of the half-time values of the second recovery phase after morphine, diamorphine or methadone treatment, despite the differences in the manner in which these drugs are distributed within and eliminated from the body (Misra, 1972) and in their physical properties (Herz & Taschemacher, 1972) argues against the conclusion that the second phase reflects the time

course of elimination of the opioid drug from the body and strongly reinforces the view that the nature of the persistent functional change underlying the morphine tolerant state is independent of the opioid drug used to induce that state. Furthermore, the failure of naloxone treatment to influence either the rapid or slow phases of recovery of the analgesic response to morphine also suggests that neither of these phases reflect the rate of dissociation of morphine-receptor complexes, since opioid antagonists are thought to compete with morphine for a common receptor site (Cox & Weinstock, 1964; Grumbach & Chernov, 1965; Pert & Snyder, 1973).

The rate at which naloxone-induced jumping activity in mice declined after the termination of the initial morphine treatment was considerably faster than the rate of loss of tolerance to the analgesic effects of morphine; Cheney & Goldstein (1971) also have reported a rapid dissipation of naloxone sensitivity in the mouse.

If there is a common mechanism associated with physical dependence and tolerance then it is characterized by a rapid relaxation ( $T_{1/2}$  3-6 h) whilst there is associated separately with tolerance to the analgesic action of morphine, an additional process with a half-time of about 17 days in mice and 13 days in rats. It is probable that the latter reflects the reversal of an opioid-induced metabolic disturbance, and knowledge of its recovery rate may assist in identification of the processes involved.

## Appendix

### *Counter for recording mouse jumping activity*

The jumping counter (Figure 8) operates on a counter-balance principle. The lever, 1, is a flat perspex strip 3 cm wide which pivots about a rod, 2, and supports the floor and rear wall of the jumping compartment, 3, which are made of 1.5 mm white perspex sheet. The excursion of the lever assembly is limited by a gate, 4, and a dashpot, 5, is provided to dampen oscillations. The position of the counter balance weight, 6, is so adjusted that the weight of a mouse on the floor of the jumping compartment is just sufficient to depress that end of the lever assembly. When the mouse jumps the position of equilibrium of the lever shifts and the tip of the adjustment screw, 7, closes the microswitch, 8 (Honeywell B2-2RW84N27-D14/68) and activates a digital counter (Type E 350:ITT Electronic Services).

The dimensions of each jumping compartment are 20 x 15 x 30 cm high; the counter used in the experiments described above has five of these,



mounted side-by-side. The three walls which enclose the moving parts of each compartment are also made of white perspex and are fixed to the chassis of the counter assembly. The front wall, 9, is hinged to facilitate cleaning the apparatus after use.

This work was supported by a grant from the Medical Research Council. We should like to thank Dr M.J. Ferster of Endo Laboratories, Inc., Brussels, for a gift of naloxone.

## References

- CHENEY, D.L. & GOLDSTEIN, A. (1971). Tolerance to opioid narcotics: time course and reversibility of physical dependence in mice. *Nature, Lond.*, **232**, 477-478.
- COCHIN, J. & KORNETSKY, C. (1964). Development and loss of tolerance to morphine in the rat after single and multiple injections. *J. Pharmac. exp. Ther.*, **145**, 1-10.
- COX, B.M., GINSBURG, M. & OSMAN, O.H. (1968). Acute tolerance to narcotic analgesic drugs in rats. *Br. J. Pharmac. Chemother.*, **33**, 245-256.
- COX, B.M., GINSBURG, M. & JULIA WILLIS (1973). The offset of morphine tolerance in rats and mice. *Br. J. Pharmac.*, **49**, 159P.
- COX, B.M. & OSMAN, O.H. (1970). Inhibition of the development of tolerance to morphine in rats by drugs which inhibit ribonucleic acid or protein synthesis. *Br. J. Pharmac.*, **38**, 157-170.
- COX, B.M. & WEINSTOCK, M. (1964). Quantitative studies of the antagonism by nalorphine of some of the actions of morphine-like analgesic drugs. *Br. J. Pharmac. Chemother.*, **22**, 289-300.
- GOLDSTEIN, A., ARONOW, A. & KALMAN, S.M. (1969). *Principles of drug action*. New York, London: Harper & Row.
- GOLDSTEIN, A. & SHEEHAN, P. (1969). Tolerance to opioid narcotics: I. Tolerance to the "running-fit" caused by levorphanol in the mouse. *J. Pharmac. exp. Ther.*, **169**, 175-184.
- GRUMBACH, L. & CHERNOV, H.I. (1965). The analgesic effect of opiate-opiate antagonist combinations in the rat. *J. Pharmac. exp. Ther.*, **149**, 385-396.
- HERZ, A. & TASCHEMACHER, H.J. (1972). Activities and sites of antinocioceptive action of morphine-like analgesics and kinetics of distribution following intravenous, intracerebral and intraventricular application. *Adv. in Drug Res.*, 79-119.
- MISRA, A.L. (1972). Disposition and metabolism of drugs of dependence. In: *Chemical and biological aspects of drug dependence*, pp. 219-277, ed. Mule, S.J. & Binn, H. Cleveland: CRC Press.
- MARSHALL, I. & WEINSTOCK, M. (1969). A quantitative method for the assessment of physical dependence of narcotic analgesics in mice. *Br. J. Pharmac.*, **37**, 505-506P.
- PERT, C.B. & SNYDER, S.H. (1973). Opiate receptors: demonstration in nervous tissue. *Science*, **179**, 1011-1014.
- RANDALL, L.O. & SELLITO, J.J. (1957). A method for measurement of analgesic activity on inflamed tissue. *Arch. Int. Pharmacodynam.*, **111**, 409-419.
- WAY, E.L., LOH, H.H. & SHEN, F.H. (1969). Simultaneous quantitative assessment of morphine tolerance and physical dependence. *J. Pharmac. exp. Ther.*, **167**, 1-8.
- WOOLFE, G. & MacDONALD, A.D. (1944). The evaluation of the analgesic action of pethidine HCl (Demerol). *J. Pharmac. exp. Ther.*, **80**, 300-307.

(Received May 22, 1974)