

Size of *cotA* and Identification of the Gene Product in *Synechocystis* sp. Strain PCC6803

MASATOSHI SONODA,¹ KATSUHIKO KITANO,¹ AKIRA KATOH,¹ HIROKAZU KATOH,²
HIROSHI OHKAWA,¹ AND TERUO OGAWA^{1,2*}

*Biochemical Regulation, School of Agriculture,¹ and Bioscience Center,² Nagoya University,
Nagoya 464-01, Japan*

Received 14 October 1996/Accepted 5 April 1997

cotA of *Synechocystis* sp. strain PCC6803 is a gene involved in light-induced proton extrusion (A. Katoh, M. Sonoda, H. Katoh, and T. Ogawa, *J. Bacteriol.* 178:5452–5455, 1996). There are two possible initiation codons in *cotA*, and either long (L-) or short (S-) *cotA* encoding a protein of 440 or 247 amino acids could be postulated. To determine the gene size, we inserted L-*cotA* and S-*cotA* into the genome of a *cotA*-less mutant (M29) to construct M29(L-*cotA*) and M29(S-*cotA*), respectively. M29(L-*cotA*) showed essentially the same net proton movement profile as the wild type, whereas no light-induced proton extrusion was observed with M29(S-*cotA*). Two kinds of antibodies were raised against partial gene products of the N- and C-terminal regions of L-*cotA*, respectively, fused to glutathione *S*-transferase expressed in *Escherichia coli*. Both antibodies cross-reacted with a band at 52 kDa in both cytoplasmic and thylakoid membrane fractions of the wild-type cells. The same cross-reacting band was present in the membranes of M29(L-*cotA*) but not in M29 or M29(S-*cotA*). These antibodies cross-reacted more strongly with the cytoplasmic membrane fraction than with the thylakoid membrane fraction. The antibody against NrtA, a nitrate transporter protein present only in the cytoplasmic membrane, also cross-reacted with the thylakoid membrane fraction strongly. Based on these results we concluded that CotA of 440 amino acids (51 kDa) is located in the cytoplasmic membrane. Whether CotA is absent in the thylakoid membrane remains to be solved.

cotA of *Synechocystis* sp. strain PCC6803 is a homolog of *cemA* which has been found in chloroplast genomes of various plants (3, 6, 15, 24, 29, 30). *cemA* genes of higher plants encode proteins of 229 to 231 amino acids (3, 24, 29, 30), whereas those of liverwort (15) and *Chlamydomonas reinhardtii* spp. (EMBL Sequence Library, accession no. X90559; N. Rolland) encode much larger proteins, of 434 and 500 amino acids, respectively, as estimated from their DNA sequences. The *cemA* product has been found in the inner envelope membrane of pea chloroplasts as a band at 34 kDa during sodium dodecyl sulfate-polyacrylamide gel electrophoresis (SDS-PAGE) (24), but the products of the liverwort and *Chlamydomonas* genes have not been identified. There are two possible initiation codons in *cotA* of *Synechocystis*. When the first ATG was postulated as the initiation codon, the gene product was a 51-kDa protein of 440 amino acids. We concluded in a previous paper that the translation started from the second ATG codon, giving a gene product of 29 kDa (247 amino acids), close in size to CemA of higher plant chloroplasts (6, 24). However, a preliminary experiment to identify the gene product suggested that it may be much larger. This led us to the present study to determine the size of *cotA* and to identify and locate the gene product.

A *cotA* deletion mutant of *Synechocystis* (M29) constructed in a previous study was used for this purpose. The mutant did not show light-induced proton extrusion and was unable to grow at pH 6.4 or in a low-sodium medium (7). We inserted long (L-) or short (S-) *cotA* into a neutral site of the genome of this mutant to see which *cotA* transforms the mutant to the wild phenotype. Measurements of growth characteristics and

light-induced proton extrusion of these two kinds of *cotA*-inserted M29 mutants and Western analysis using antibodies raised against partial gene products enabled us to determine the size of *cotA* and to identify and locate the gene product.

MATERIALS AND METHODS

Growth conditions. Wild-type (WT) and mutant cells of *Synechocystis* sp. strain PCC6803 were grown at 30°C in BG-11 medium (28) buffered with 20 mM *N*-tris(hydroxymethyl)methyl-2-aminoethanesulfonic acid (TES)-KOH at pH 8.0 during aeration with 3% (vol/vol) CO₂ in air. Continuous illumination was provided by fluorescent lamps at 120 μmol of photosynthetically active radiation/m²s (400 to 700 nm).

Transformation of *Synechocystis*. An L-*cotA* or S-*cotA* gene was inserted into a neutral site of the genome of a *cotA*-less mutant (M29) of *Synechocystis* sp. strain PCC6803 (see Fig. 1 and 2). The plasmid containing L-*cotA* or S-*cotA* with the kanamycin resistance (Km^r) cartridge (16) was used to transform M29 cells into Km^r mutants, by the protocol of Williams and Szalay (31).

Measurements of proton exchange. Net proton exchange was measured at 30°C as described previously (5, 7). Cells were harvested by centrifugation, washed twice with 0.2 mM TES-KOH buffer (pH 8.0), and then suspended in the same buffer containing 15 mM NaCl and chlorophyll at a concentration of 14 μg/ml. The pH of the cell suspension was monitored by a pH electrode with a meter (Inlar 423 electrode and Delta 350 meter; Mettler Toledo, Halstead, Essex, United Kingdom). Light from a 150-W halogen lamp was guided by a glass fiber (catalog no. MHF-150L; Kagaku Kyoeshisa Ltd., Osaka, Japan) to illuminate the sample in the chamber at an intensity of 4.0 mmol of photosynthetically active radiation/m²s.

Preparation of antibodies. The DNA fragments encoding 191- and 38-amino-acid residues of the N- and C-terminal regions of *cotA* (see Fig. 2), amplified by PCR (22), were ligated to pGEX-2T (Pharmacia, Uppsala, Sweden) containing the glutathione *S*-transferase (GST) gene (*gst*). The fusion proteins (GST-191 and GST-38) were induced for 3 h at 37°C by adding 1 mM isopropyl-β-D-thiogalactopyranoside (IPTG) to *Escherichia coli* cells transformed with the chimeric plasmids. The GST protein was also expressed in *E. coli*. GST-38 formed inclusion bodies, while GST-191 and GST were recovered as soluble proteins. The inclusion bodies were isolated, solubilized with 5% SDS, and electrophoresed by SDS-PAGE (4, 9). A predominant GST-38 band at 31 kDa was cut out from the gel and was mashed with a mortar and pestle to be injected into rabbits. GST-191 and GST were purified on a glutathione-Sepharose 4B column (Pharmacia).

The antibodies against GST-191 and GST-38 fusion proteins were obtained from rabbits according to the standard procedure (2). The antibody against

* Corresponding author. Mailing address: Bioscience Center, Nagoya University, Chikusa-ku, Nagoya 464-01, Japan. Phone: 81-52-789-5215. Fax: 81-52-789-5214. E-mail: h44975a@nucc.nagoya-u.ac.jp.

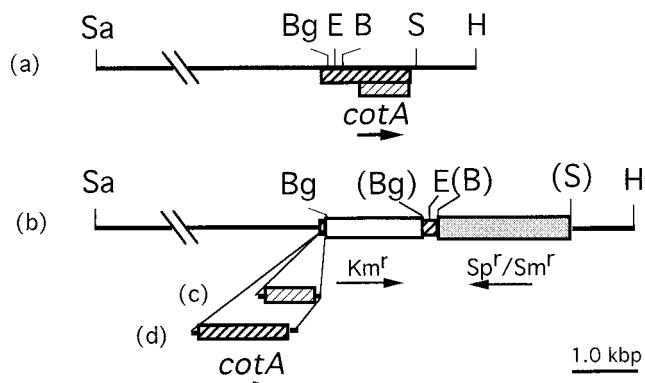

FIG. 1. (a) Restriction map of a 6.9-kbp DNA insert in plasmid pSC. *L-cotA* and *S-cotA* are indicated by the thickly and thinly hatched bars, respectively, with the arrow showing the direction of transcription. (b) The 1.1-kbp *Bam*HI/*Spe*I fragment was replaced with the omega fragment (*Sp*^r/*Sm*^r cartridge) (21) and the kanamycin resistance cartridge was inserted at the *Bgl*II site to produce plasmid pKMSC. DNA fragments containing *S-cotA* and *L-cotA* were inserted at the *Bgl*II site in the pKMSC plasmid to produce the pKMSC(*S-cotA*) (c) and pKMSC(*L-cotA*) (d) plasmids. The sites shown in parentheses are not present in the constructs. Abbreviations for restriction enzymes: B, *Bam*HI; Bg, *Bgl*II; E, *Eco*RI; H, *Hpa*I; S, *Spe*I; Sa, *Sal*I.

GST-38 was purified by the method reported by Kelly et al. (8). The fused protein in the gel was blotted onto a polyvinylidene difluoride membrane and reacted with the antibody. After washing, the antibody was eluted from the membrane with 0.2 M glycine-HCl solution (pH 2.8), containing 1 mM EGTA and bovine serum albumin (0.1 mg/ml). The antibody immunospecific to GST was similarly purified from the antibody against GST-38. The antiserum for GST-191 was used for Western analysis without further purification.

Preparation of membrane and soluble fractions. Cytoplasmic and thylakoid membranes and soluble fractions were prepared from the WT cells by modification (20) of the method of Omata and Murata (17). Cells were disrupted through a French pressure cell at 120 MPa. Total membrane fractions were prepared from the WT and mutant cells as described by Nilsson et al. (11).

Electrophoresis and Western analysis. SDS-PAGE was performed according to the system of Laemmli (9) as modified by Ikeuchi and Inoue (4). Polypeptides were electrotransferred to a nitrocellulose membrane and reacted with the antibodies. Goat anti-rabbit immunoglobulin G conjugated to peroxidase was used as the secondary antibody, and reacting bands were detected with an enhanced chemiluminescence kit (Amersham).

Northern blot analysis. To determine the size of transcript of the *cotA* gene, RNAs in the WT and mutant cells of *Synechocystis* were extracted by the method of Aiba et al. (1). The probes used for hybridization were PCR products containing *S-cotA* (see Fig. 1 and 2) and the carbonic anhydrase-like gene (open reading frame [ORF] slr0051 in the CyanoBase sequence bank of the Kazusa DNA Research Institute).

Other methods. Unless otherwise stated, standard techniques were used for DNA manipulation (23). Pigments in the cells were extracted by methanol, and the chlorophyll concentration in the extract was determined (14).

RESULTS

Insertion of different sizes of *cotA* into a *cotA*-less mutant.

The pSC plasmid contains the *cotA* gene of *Synechocystis* sp. strain PCC6803 in a 6.9-kbp DNA insert (Fig. 1a) in the pKY184 vector (29). Two sizes of *cotA*, encoding proteins of 440 and 247 amino acids, are shown (Fig. 1a). The *Bam*HI/*Spe*I fragment containing *cotA* was replaced by the omega fragment (21) to produce plasmid pMSC, which was used to construct the *cotA*-less mutant of *Synechocystis*, M29 (not shown; see reference 7). A kanamycin (*Km*^r) cartridge having the *Bgl*II and *Bam*HI sites at each end (synthesized by the PCR method with *pUC4K* as a template) was inserted at the *Bgl*II site of pMSC to produce plasmid pKMSC (Fig. 1b). The DNA

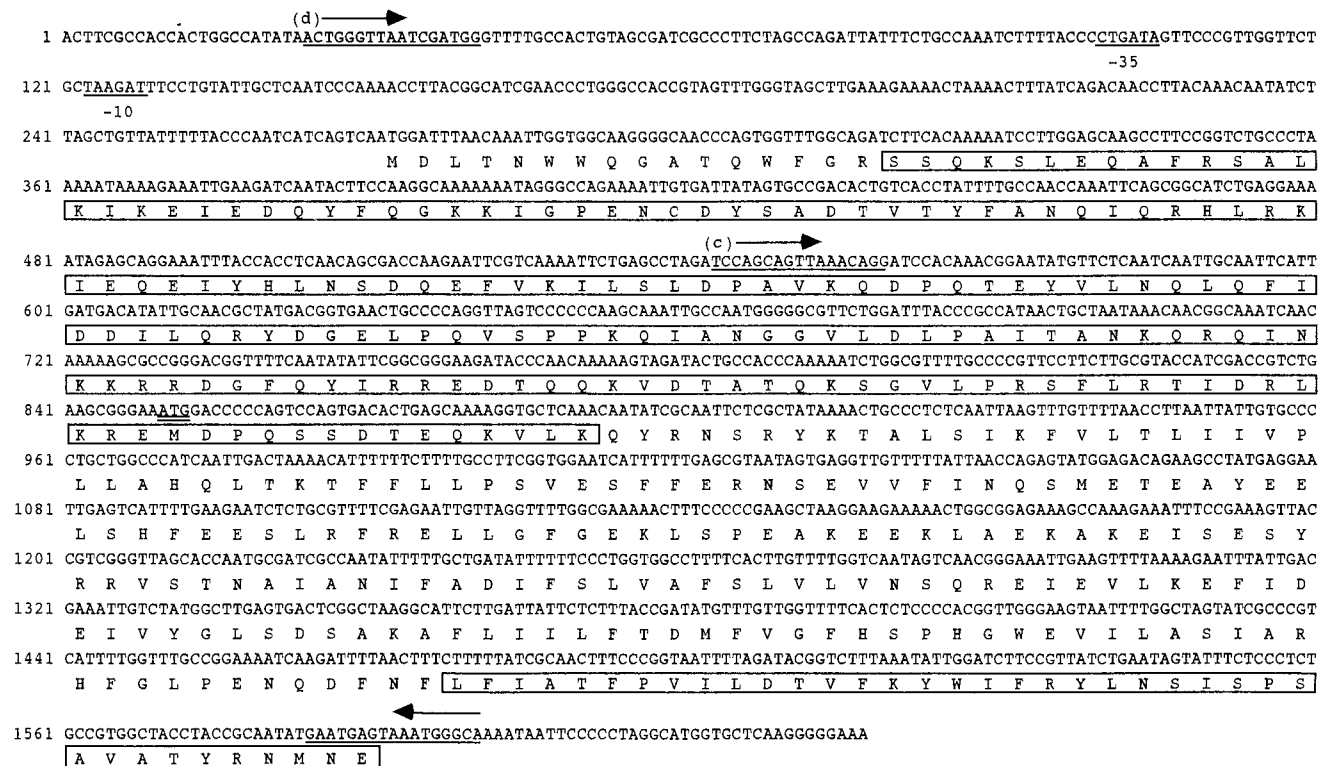

FIG. 2. Nucleotide sequence of DNA in the region of *cotA* and deduced amino acid sequence (single-letter code) of the protein encoded by *cotA*. The putative promoter sequences (−10 and −35) are underlined. Sequences of primers used for PCR to synthesize *S-cotA* (c) and *L-cotA* (d) are also underlined, and arrows above the sequence indicate the directions. An initiation codon postulated for *S-cotA* is double underlined.

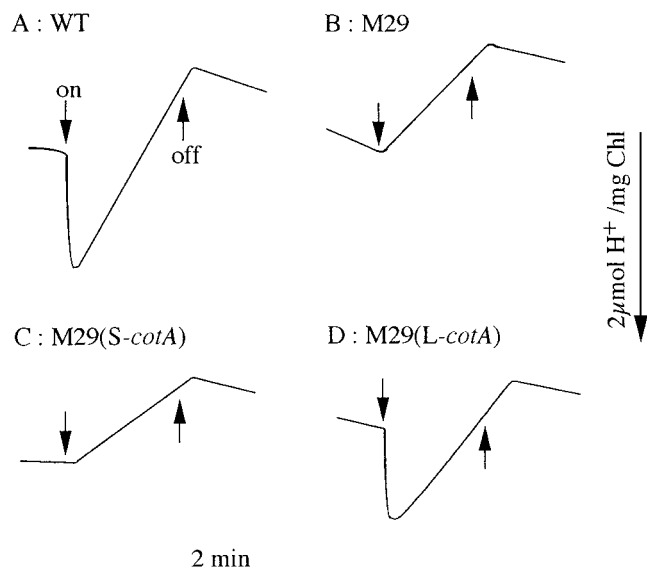

FIG. 3. Changes in pH of cell suspensions upon switching the light on and off. WT (A), M29 (B), M29(*S-cotA*) (C), and M29(*L-cotA*) (D) cells were suspended in 0.2 mM TES-KOH buffer (pH 8.0) containing 15 mM NaCl. Chl, chlorophyll.

fragments containing *S-cotA* and *L-cotA* were synthesized by the PCR method (using primers shown in Fig. 2) and were inserted into pKMSC to produce the pKMSC(*S-cotA*) and pKMSC(*L-cotA*) plasmids, respectively (Fig. 1c and d). These plasmids were used to transform M29 to Km^r through homologous recombination. The transformants are referred to in this work as M29(*S-cotA*) and M29(*L-cotA*), respectively.

Growth characteristics. M29(*L-cotA*) and M29(*S-cotA*) cells were grown in BG-11 medium buffered at pH 8.0 and then on agar plates buffered to pH 8.0 or 6.5. Kanamycin (10 μg/ml) was added to the medium, and 3% (vol/vol) CO₂ in air was supplied during the culture. Both M29(*L-cotA*) and M29(*S-cotA*) grew well on the plates buffered to pH 8.0, but M29(*S-cotA*) was unable to grow on the plates buffered to pH 6.5. Thus, M29(*S-cotA*) still showed the mutant phenotype whereas M29(*L-cotA*) formed many colonies even at pH 6.5.

Net proton movements. When the WT cells suspended in 0.2 mM TES-KOH buffer (pH 8.0) containing 15 mM NaCl were illuminated, there was an acidification followed by an alkalization of the medium (Fig. 3A). The light-induced acidification was not observed with the M29 mutant; only alkalization of the medium was observed (Fig. 3B). These characteristics of the WT and mutant were essentially the same as those reported previously (7). The M29(*S-cotA*) cells showed the same characteristics as M29 (Fig. 3C). In contrast, M29(*L-cotA*) showed the WT activity of light-induced proton extrusion (Fig. 3D). The results clearly demonstrated that *L-cotA* but not *S-cotA* is functional for light-induced proton extrusion.

Identification of CotA. Western analysis of the membrane and soluble fractions of the WT *Synechocystis* sp. strain PCC6803 indicated that a protein in the cytoplasmic and thylakoid membrane fractions with an apparent molecular mass of 52 kDa cross-reacted with the antibody raised against GST-191 (lanes b and d in Fig. 4). The same band cross-reacted with the antibody raised against GST-38. No reacting band was observed in the soluble fraction (lane f). The antibody immunospecific to the GST protein did not react with this band (data not shown), indicating that the protein cross-reacted with the antibodies immunospecific to the partial CotA in the fused

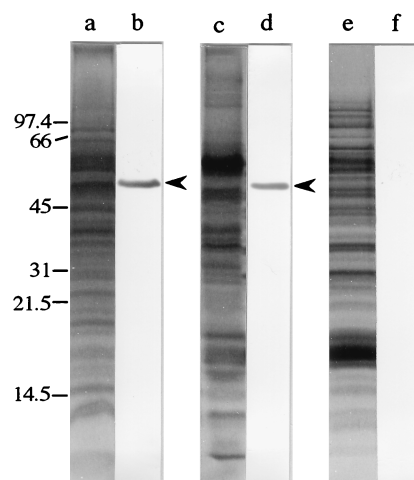

FIG. 4. Electrophoretic profiles showing CBB staining patterns of polypeptides (lanes a, c, and e) and immunoblots of CotA (b, d, and f) in the cytoplasmic membrane (a and b) and thylakoid membrane (c and d) fractions and soluble fraction (e and f) of *Synechocystis* sp. strain PCC6803. Samples (30 μg of proteins for CBB staining and 15 μg for immunoblotting) were solubilized at room temperature, boiled for a few minutes, and run in a 12% gel containing 7 M urea. The antibody against GST-191 was used for immunoblottings. The sizes of marker proteins are indicated (in kilodaltons) on the left.

proteins. To confirm that the 52-kDa cross-reacting band is the product of *cotA*, Western analysis was performed with the total membrane fractions prepared from the WT, M29, M29(*L-cotA*), and M29(*S-cotA*) cells, and the results are shown in Fig. 5. No cross-reacting band was observed at 52 kDa in the mem-

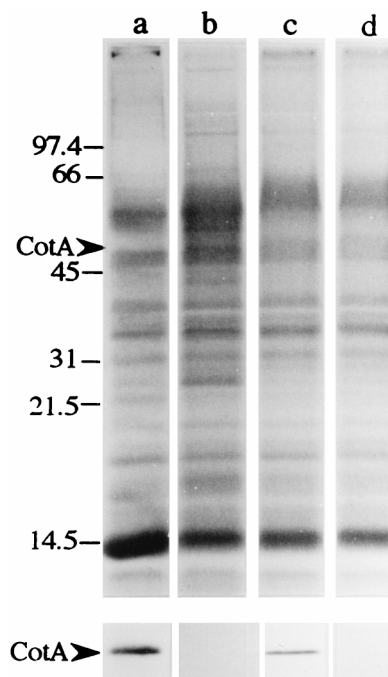

FIG. 5. Electrophoretic profiles showing CBB staining patterns of polypeptides (upper lanes) and immunoblots of CotA (lower lanes) of the membrane fractions of WT (lane a), M29 (lane b), M29(*L-cotA*) (lane c), and M29(*S-cotA*) (lane d). The conditions for SDS-PAGE and the indication of marker proteins are as described in the legend to Fig. 4. The antibody against GST-38 was used for immunoblottings.

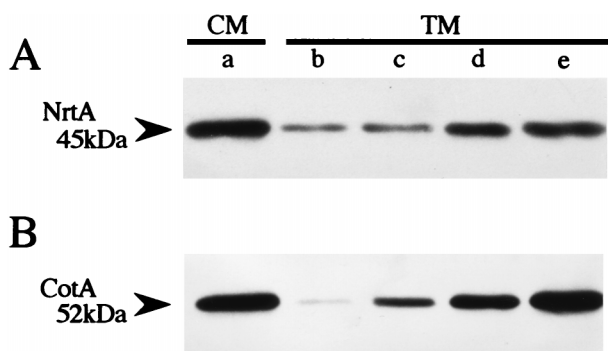

FIG. 6. Immunoblots of NrtA (upper column) and CotA (lower column) in the cytoplasmic membrane (CM [lane a]) and thylakoid membrane (TM [lanes b to e]) fractions of *Synechocystis* sp. strain PCC6803. The conditions used for SDS-PAGE are described in the legend to Fig. 3, and the amounts of proteins loaded were 15 μ g (lane e), 7.5 μ g (lanes a and d), 3 μ g (lane c), and 1.5 μ g (lane b).

brane fractions of M29 or M29(*S-cotA*). As expected, the cross-reacting 52-kDa band was clearly observed with the WT membranes and the same cross-reacting band was found in the M29(*L-cotA*) membrane fraction. Evidently, the protein that cross-reacted with the antibodies is the product of *cotA* (CotA). The size of CotA estimated from SDS-PAGE agreed with that deduced from the nucleotide sequence of *L-cotA*. The 52-kDa band was not detected on the Coomassie brilliant blue R-250 (CBB) staining profiles of the membranes of WT or M29(*L-cotA*) (lanes a and c in Fig. 4 and lanes a and c in Fig. 5). The amount of CotA appears to be low.

Location of CotA. Both cytoplasmic and thylakoid membrane fractions of the WT contained CotA (Fig. 4). It was not possible to isolate these two types of membranes from *Synechocystis* sp. strain PCC6803 cells without cross-contamination. Therefore, the presence of CotA in the fractions of these two types of membranes do not necessarily mean that CotA is present in both membranes. As reported previously, about one-fourth of the proteins in the cytoplasmic membrane fraction originated from contaminated thylakoid membrane (12). In order to test whether the thylakoid membrane fraction is free from contaminated cytoplasmic membrane, we have tested the cross-reactivity of the thylakoid membrane fraction to the antibody against NrtA, which is a protein involved in nitrate transport and is localized only in the cytoplasmic membrane of *Synechococcus* sp. strain PCC7942 (18, 19). The antibody against NrtA strongly cross-reacted with the thylakoid membrane fraction of *Synechocystis*, with the cross-reactivity about half that with the cytoplasmic membrane fraction (Fig. 6A). This result, together with the 25% contamination of thylakoid membrane in the cytoplasmic membrane fraction (12), indicated that about 38% of the proteins in the thylakoid membrane fraction originated from contaminated cytoplasmic membrane. If CotA is localized only in the thylakoid membrane, the cross-reactivity of the thylakoid membrane fraction with the antibody against GST-191 must be about 2.5 times that of the cytoplasmic membrane fraction. The cross-reactivity of the antibody against GST-191 with the thylakoid membrane fraction was, however, about half that with the cytoplasmic membrane fraction (lanes b and d in Fig. 4, lanes a and d in Fig. 6B). The results clearly demonstrated that CotA is located in the cytoplasmic membrane. The cross-reactivities of the antibodies against GST-191 and NrtA with the thylakoid membrane fraction were similar, which suggested that the antibody against GST-191 cross-reacted predominantly, if not

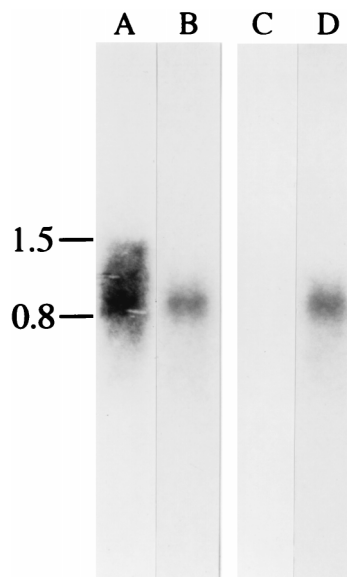

FIG. 7. Northern blot analysis of total RNA from WT (lanes A and B) and M29 (lanes C and D) cells of *Synechocystis* sp. strain PCC6803. RNA was denatured with formaldehyde, electrophoresed on a 1.2% agarose gel, transferred to a nylon membrane, and hybridized with the 32 P-labeled DNA fragment containing *S-cotA* (lanes A and C) or the carbonic anhydrase-like gene (lanes B and D). RNA sizes are shown to the left (in kilobases).

totally, with contaminated cytoplasmic membrane. It is, however, not possible at present to exclude the possibility that a small amount of CotA is present in the thylakoid membrane.

Northern analysis. Northern analysis with RNAs prepared from the WT in the previous study indicated that the *cotA* transcript is 0.8 kb (6), which is much smaller than the *L-cotA* transcript. The *Bam*HI/*Spe*I fragment used as a probe in the previous study, however, cross-reacted with the transcript for the ORF on the complementary strand downstream of *cotA*. This ORF was strongly expressed, and the size of the transcript was 0.8 kb (1a). To avoid this complexity, we used the PCR product containing *S-cotA* as a probe (Fig. 1 and 2) and performed Northern analysis with RNAs from the WT and M29. The transcript was found in the WT as a smear band starting at 1.4 to 1.5 kb, but no hybridizing band was detected with M29 (lanes A and C in Fig. 7). Thus, the probe specifically cross-reacted with the *cotA* transcript of the *L-cotA* size. When the carbonic anhydrase-like gene was used as a probe, both WT and mutant RNAs gave a single band at 950 bases (lanes B and D). Thus, the quality of these RNA preparations is sufficiently high.

***cotA* sequences.** The nucleotide sequence of *L-cotA* and the amino acid sequence deduced from the nucleotide sequence are shown in Fig. 2, where amino acid sequences in the fusion proteins, GST-191 and GST-38, are boxed. There was no Shine-Dalgarno (26) sequence upstream of the initiation codon. A possible promoter sequence can be found upstream of the initiation codon at bases 100 to 105 (CTGATA [-35 box]) and 123 to 128 (TAAGAT [-10 box]).

Comparison of CotA and CemA sequences. As reported in a previous paper (6), the amino acid sequence deduced from the nucleotide sequence of the *cotA* gene of *Synechocystis* sp. strain PCC6803 showed significant similarity to the sequences of *cemA* gene products of various plants (3, 15, 24, 27, 30). Figure 8 shows the homology in the amino acid sequences among CotA of *Synechocystis* and CemA of liverwort (15) and

S.6803 MDL-TNWWQGATQWFRSSQKSLAQFRSALK-----IKEIEDQYF-----QGKKIGP----ENCDSYAD-----TVTY-----FANQIQRHLRRIEIQEYIHLN
 Marpo :KKNFSY:RIFHHI:ALPYC-:::K:YKASKR-----:QK:KKD:::-----LY:N:LF-----SSKRSWQS-----ILF:-----IDTELNNSVF::YLSL:EYK
 Chlamy :YT-FIYFKNPKHFNLSQPSRCTA:P:I:TRNRPLSCP:PTVQPI:VTHGIILPILKGTLSISQR:VN:V:FVSKRDS:YT:KDKVSI::EEIGLFPRS:SRVLD:F:KQLFSDVDN:V

SDQ-EFVKI-LSLD-----PAVKQDPQTEYVLNQL-QF-----IDDILQRYDGLPQVSP-PKQIANGGVLDLPAITANKQRQINKKR-RDGFQYIRREDTQKQVDTATQKSG
 LSL-WLIQLF:IFS-----LFF:KNSKFDLI:PNI-NEK:KRRK:NRK:AWIRAT:NDLESWRYYLFSFS:S:-----D::E-KNN:SFLQMKSSRLTA-I:YESI:
 IQEYR:YRY-:F:TTIKTIFILFFV:FLVNFAAKN:IVKPITEYFWNTSHP EIF:NS:EQKRAF:EL-A:FEEKIYFET:VESHSBH:THRDS:PL:ENGI:FPDGEFLDNANLLSTPRS

VLPRSFLR-TIDRLKREMPQSSDTEQKVLKQYRNSRYKTALSIFVLTLLIIVPLLAHQLTKTFFLLPSVESFF--ERNSEVVFINQSMETEAYE-ELSHF----EESLRFRELLGF-GE
 LV::IT:-:FS:F:A:LTN::SL---::EF:LAK:QALA:LQYIGC:FFI::GVSFFFQKC::E:WIQNW--NIYQSQI:LTSFQ:EK:LK-K:QEI-----:LFWLDKVMYTSN
 INSN::KQN::ISL::EK:LTLVQGVNL:EE-----:KE:N:P--:AQENIANNQSIPO:S:GQGNFS:L:TGD:EG:ETAKQNLSSQRVIGAN:RQIYLPSA:GEMLPSIR:-SLD

KLSPAEKKEKLAEKAKEISESYRRVSTNAIANIFADIFSLVAFSLVLVNSQREIEVLKEFIDEIVGLSDSAAKAFLLIILFTDMFVGFHSPHGWEVILASIAHFGLPENQDFNFLFIATF
 :IQLQDLTKREHQQT:I:LVQI:NND:IKIVLHLLT:LIIWFITL:CLFILGKERLVI:NSWAQ:LF:S:::TM:::F:L:L:LCI:::IVIS:CLE::FVH:KHVISC:VS::
 SIXNKDISKIYQ:TI:LATY:NNH:IE::T:F::LL:FTLLYL:ITLEIQ:NIT:S:LL:VFF:D:K:SL:I:L:LL:Y:SNL:LFFEF:FN:Y:I:S:TGI::LV::L

PVILDVFKYWFIRYLNISPSAVATYRNMNE 440
 ::::::::::L::H::R:::I:::HT::: 434
 ::L::VL::L::H::RS::AT:::QAI: 500

FIG. 8. Comparison of the deduced amino acid sequences for CotA of *Synechocystis* (S.6803), CemA of liverwort (*Marpo*), and *Chlamydomonas* (*Chlamy*). Residues in CemA identical to corresponding residues in CotA are indicated (:).

Chlamydomonas. The homology was high in the C-terminal regions but was low in the N-terminal regions.

DISCUSSION

The present study clearly demonstrated that *cotA* consists of 1,320 nucleotides and encodes a protein of 440 amino acids. Northern analysis using a probe specific to *cotA* (Fig. 7) and the strong cross-reactivity of the antibodies against GST-191 and GST-38 with a band at 52 kDa (Fig. 4 and 5) supported this result. Therefore, CotA has 200 additional amino acids differing from CemA of higher plants and is similar in size to CemA of liverwort (15) and *Chlamydomonas*. Although there was significant homology in the amino acid sequences in the C-terminal region among CotA of *Synechocystis* and CemA of various plants (3, 15, 24, 27, 30) and *Chlamydomonas*, the homology of the additional 200- to 250-amino-acid sequences in the N-terminal region was low among CotA and CemA of liverwort and *Chlamydomonas* (Fig. 8). These amino acids in the N-terminal regions might have been lost in the course of evolution.

The antibodies raised against GST-191 and GST-38 cross-reacted with the cytoplasmic and thylakoid membrane preparations. As described in Results, the stronger cross-reactivity of the antibodies with the cytoplasmic membrane fraction indicates that CotA is present in the cytoplasmic membrane. The thylakoid membrane fraction of *Synechocystis* sp. strain PCC7942 contains about 8% contaminated cytoplasmic membrane (18). The same fraction from *Synechocystis* was, however, contaminated with more cytoplasmic membrane. Although results in this study showed that the cross-reactivity of the antibodies with the thylakoid membrane fraction is predominantly, if not totally, due to contaminated cytoplasmic membrane, we were unable to exclude the possibility that thylakoid membrane contains a small amount of CotA. CemA, a homolog of CotA, is absent in the thylakoid membrane of pea chloroplasts (24). This strongly suggests that CotA is also absent in the thylakoid membrane of *Synechocystis*.

Light-induced proton extrusion has been observed with various cyanobacterial strains (5, 7, 10, 13, 25). The proton extrusion was abolished in a *cotA* deletion mutant (M29) (Fig. 3B and reference 7). The finding of the recovery of light-induced proton extrusion in M29(L-*cotA*) confirmed that the inhibition of this activity was not the result of a pleiotropic effect of *cotA*

deletion. Thus, CotA in the cytoplasmic membrane has a role in the light-induced proton extrusion, although the exact function of CotA in this reaction is not known. The absence of an ATP-binding motif in *cotA* indicates that CotA is not an H⁺-ATPase itself. It is possible that CotA plays a role in regulating or activating an H⁺-ATPase or it could be another type(s) of proton pump. Further studies are in progress to answer these questions on the role of CotA.

ACKNOWLEDGMENTS

This study was supported by a Grant-in-Aid for Scientific Research on Priority Areas (no. 0427103) from the Ministry of Education, Science, and Culture, Japan, and by the New Energy and Industrial Technology Development Organization (NEDO), Japan.

We thank T. Omata (Nagoya University) for providing us with the antibody against NrtA.

REFERENCES

- Aiba, H., S. Adhya, and B. de Crombrughe. 1981. Evidence for two functional *gal* promoters in intact *Escherichia coli* cells. *J. Biol. Chem.* **256**:11905-11910.
- Fukuzawa, H. Personal communication.
- Harlow, E., and D. Lane (ed.). 1988. *Antibodies: a laboratory manual*, p. 92-119. Cold Spring Harbor Laboratory Press, Cold Spring Harbor, N.Y.
- Hiratsuka, J., H. Shimada, R. Whittier, T. Ishibashi, M. Sakamoto, M. Mori, C. Kondo, Y. Honji, C. R. Sun, B. Y. Meng, Y. Q. Li, A. Kanno, Y. Nishizawa, A. Hirai, K. Shinozaki, and M. Sugiura. 1989. The complete sequence of the rice (*Oryza sativa*) chloroplast genome: intermolecular recombination between distinct trRNA genes accounts for a major plastid DNA inversion during the evolution of the cereals. *Mol. Gen. Genet.* **217**:185-194.
- Ikeuchi, M., and Y. Inoue. 1988. A new 4.8-kDa polypeptide intrinsic to the PSII reaction center, as revealed by modified SDS-PAGE with improved resolution of low-molecular-weight proteins. *Plant Cell Physiol.* **29**:1233-1239.
- Kaplan, A., S. Scherer, and M. Lerner. 1989. Nature of the light-induced H⁺ efflux and Na⁺ uptake in cyanobacteria. *Plant Physiol.* **89**:1220-1225.
- Katoh, A., K. S. Lee, H. Fukuzawa, K. Ohyama, and T. Ogawa. 1996. *cemA* homolog essential to CO₂ transport in the cyanobacterium, *Synechocystis* PCC6803. *Proc. Natl. Acad. Sci. USA* **93**:4006-4010.
- Katoh, A., M. Sonoda, H. Katoh, and T. Ogawa. 1996. Absence of light-induced proton extrusion in a *cotA*-less mutant of *Synechocystis* sp. strain PCC6803. *J. Bacteriol.* **178**:5452-5455.
- Kelly, J. L., A. L. Greenleaf, and I. R. Lehman. 1986. Isolation of the nuclear gene encoding a subunit of the yeast mitochondrial RNA polymerase. *J. Biol. Chem.* **261**:10348-10351.
- Laemmli, U. K. 1970. Cleavage of structural proteins during the assembly of the head of bacteriophage T4. *Nature (London)* **227**:680-685.
- Lockau, W., and S. Pfeffer. 1982. A cyanobacterial ATPase distinct from the coupling factor of photophosphorylation. *Z. Naturforsch. Teil C* **37**:658-664.
- Nilsson, F., D. J. Simpson, C. Jansson, and B. Andersson. 1992. Ultrastructural and biochemical characterization of a *Synechocystis* 6803 mutant with

- inactivated *psbA* genes. Arch. Biochem. Biophys. **295**:340–347.
12. Ogawa, T. 1992. Identification and characterization of the *ictA/ndhL* gene product essential to inorganic carbon transport of *Synechocystis* PCC6803. Plant Physiol. **99**:1604–1608.
 13. Ogawa, T., and A. Kaplan. 1987. The stoichiometry between CO₂ and H⁺ fluxes involved in the transport of inorganic carbon in cyanobacteria. Plant Physiol. **83**:888–891.
 14. Ogawa, T., and K. Shibata. 1965. A sensitive method for determining chlorophyll b in plant extracts. Photochem. Photobiol. **4**:193–200.
 15. Ohyama, K., H. Fukuzawa, T. Kohchi, H. Shirai, T. Sano, S. Sano, K. Umesono, Y. Shiki, M. Takeuchi, Z. Chang, S. Aota, H. Inokuchi, and H. Ozeki. 1986. Chloroplast gene organization deduced from complete sequence of liverwort *Marchantia polymorpha* chloroplast DNA. Nature (London) **322**:572–574.
 16. Oka, A., H. Sugisaki, and M. Takanami. 1981. Nucleotide sequence of the kanamycin resistance transposon Tn903. J. Mol. Biol. **147**:217–226.
 17. Omata, T., and N. Murata. 1983. Isolation and characterization of the cytoplasmic membranes from the blue-green alga (cyanobacterium) *Anacystis nidulans*. Plant Cell Physiol. **24**:1101–1112.
 18. Omata, T., and N. Murata. 1986. Glycolipid synthesis activities in cytoplasmic and thylakoid membranes from the cyanobacterium, *Anacystis nidulans*. Plant Cell Physiol. **27**:485–490.
 19. Omata, T., M. Ohmori, N. Arai, and T. Ogawa. 1989. Genetically engineered mutant of the cyanobacterium *Synechocystis* PCC7942 defective in nitrate transport. Proc. Natl. Acad. Sci. USA **86**:6612–6616.
 20. Omata, T., and T. Ogawa. 1986. Biosynthesis of a 42-kD polypeptide in the cytoplasmic membrane of the cyanobacterium *Anacystis nidulans* strain R2 during adaptation to low CO₂ concentration. Plant Physiol. **80**:525–530.
 21. Prentki, P., and H. M. Krisch. 1984. *In vitro* insertional mutagenesis with a selectable DNA fragment. Gene **29**:303–313.
 22. Saiki, R. K., D. H. Gelfand, S. Stoffel, S. J. Scharf, R. Higuchi, G. T. Horn, K. B. Mullis, and H. A. Erlich. 1988. Primer-directed enzymatic amplification of DNA with a thermostable DNA polymerase. Science **239**:487–491.
 23. Sambrook, J., E. F. Fritsch, and T. Maniatis. 1989. Molecular cloning: a laboratory manual, 2nd ed. Cold Spring Harbor Laboratory Press, Cold Spring Harbor, N.Y.
 24. Sasaki, Y., K. Sekiguchi, Y. Nagano, and R. Matsuno. 1993. Chloroplast envelope protein encoded by chloroplast genome. FEBS Lett. **316**:93–98.
 25. Scherer, S., I. Hinrichs, and P. Böger. 1988. Light-induced proton release by the cyanobacterium *Anabaena variabilis* dependence on CO₂ and Na⁺. Plant Physiol. **86**:769–772.
 26. Shine, J., and L. Dalgarno. 1975. Determination of cistron specificity in bacterial ribosomes. Nature (London) **254**:34–38.
 27. Shinozaki, K., M. Ohme, M. Tanaka, T. Wakasugi, N. Hayashida, T. Matsumoto, N. Zaita, J. Chunwongse, J. Obokata, K. Yamaguchi-Shinozaki, C. Ohto, K. Torazawa, B. Y. Meng, M. Sugita, H. Deno, T. Kamogashira, K. Yamada, J. Kusuda, F. Takaiwa, A. Kato, N. Tohdoh, H. Shimada, and M. Sugiura. 1986. The complete nucleotide sequence of the tobacco chloroplast genome: its gene organization and expression. EMBO J. **5**:2043–2049.
 28. Stanier, R. Y., R. Kunisawa, M. Mandel, and G. Cohen-Bazire. 1971. Purification and properties of unicellular blue-green algae (order *Chroococcales*). Bacteriol. Rev. **35**:171–205.
 29. Ueguchi, C., and K. Itoh. 1992. Multicopy suppression: an approach to understanding intracellular functioning of the protein export system. J. Bacteriol. **174**:1454–1461.
 30. Willey, D. L., and J. C. Gray. 1990. An open reading frame encoding a putative haem-binding polypeptide is cotranscribed with the pea chloroplast gene for apocytochrome f. Plant Mol. Biol. **15**:347–356.
 31. Williams, J. G. K., and A. A. Szalay. 1983. Stable integration of foreign DNA into the chromosome of the cyanobacterium *Synechocystis* R2. Gene **24**:37–51.