

A Role for Natural Antibody in the Pathogenesis of Leprosy: Antibody in Nonimmune Serum Mediates C3 Fixation to the *Mycobacterium leprae* Surface and Hence Phagocytosis by Human Mononuclear Phagocytes

LARRY S. SCHLESINGER† AND MARCUS A. HORWITZ*

Division of Infectious Diseases, Department of Medicine, UCLA School of Medicine,
Center for Health Sciences, Los Angeles, California 90024-1688

Received 11 March 1993/Returned for modification 4 June 1993/Accepted 6 October 1993

We have previously determined that complement receptors on human mononuclear phagocytes and complement component C3 in nonimmune serum mediate phagocytosis of the intracellular bacterial pathogen *Mycobacterium leprae*, the agent of leprosy. We have also determined that C3 fixes selectively to the major surface glycolipid of *M. leprae*, phenolic glycolipid 1 (PGL-1). In this study, we have explored the role of natural antibody in nonimmune serum in C3 fixation and C1q binding to *M. leprae* and PGL-1. At serum concentrations within the range at which phagocytosis of *M. leprae* is maximal, C3 fixation was mediated by both the classical and the alternative complement pathways. At the low end of this serum concentration range (2.5%), C3 fixation was mediated predominantly by the classical pathway. Consistent with a role for both pathways, C3 fixation to *M. leprae* was enhanced by the addition of either pure C1q to C1q-depleted serum or pure factor B to factor B-depleted serum. C3 fixation to *M. leprae* was strictly antibody dependent regardless of the serum concentration used. C3 fixation to *M. leprae* occurred in nonimmune serum but not in agammaglobulinemic serum unless heat-inactivated nonimmune serum or small amounts of pure immunoglobulin G (IgG) or IgM were added. C3 fixation by both the alternative and the classical complement pathways was mediated by antibody, and the antigen-binding portion of the antibody molecule was required. C3, IgG, IgM, and C1q were readily detected on the surface of *M. leprae*. Consistent with the previously demonstrated exclusive role of the classical complement pathway in C3 fixation to PGL-1, C1q bound to PGL-1 in a dose-dependent fashion; C1q binding was evident in >1.25% nonimmune serum. C1q binding to PGL-1 was strictly antibody dependent. When PGL-1 was incubated with pure C1q, little or no C1q bound to PGL-1 unless heat-inactivated nonimmune serum or pure IgG or IgM was added. When PGL-1 was incubated in nonimmune serum, C3 bound directly to PGL-1 and not to anti-PGL-1 antibody, since the amount of C3 bound to PGL-1 was not reduced by acid elution of the antibody. However, the amount of C3 bound to PGL-1 was markedly reduced by hydroxylamine treatment, providing evidence for C3 fixation via a covalent ester bond. Nonimmune serum contained antibody to all four major *M. leprae* surface carbohydrates. Relative to PGL-1, nonimmune serum contained more antibody to the other surface carbohydrates. This study demonstrates that natural antibody in the serum of nonimmune hosts mediates C3 fixation to *M. leprae* and C1q binding to PGL-1. Taken together with previous findings, this study indicates that natural antibody mediates complement receptor-dependent phagocytosis of *M. leprae* by host cells and therefore potentially plays an important role in the pathogenesis of leprosy.

Mycobacterium leprae, the causative agent of leprosy, is an intracellular bacterial pathogen that invades host mononuclear phagocytes. We have previously determined that complement receptors (CR1, CR3, and CR4) on human mononuclear phagocytes, fragments of complement component C3 in nonimmune serum, which bind to the surface of *M. leprae*, and PGL-1, the major surface glycolipid of *M. leprae*, form a three-component receptor-ligand-acceptor molecule system for mediating phagocytosis of *M. leprae* (13-15). In contrast to PGL-1, other *M. leprae* surface carbohydrates, including LM, LAM, and arabinogalactan, do not fix appreciable amounts of C3 (15).

Small amounts of natural antibody (antibody in nonimmune serum) to several species of mycobacteria, both immunoglobulin G (IgG) and IgM, have been found in normal healthy persons and may represent cross-reactive antibody to shared antigenic components between mycobacteria and other microbial species (1, 16). This antibody in normal serum may account for the background activity observed in ELISA systems that detect immunoglobulin to whole *M. leprae* (16). The role of natural antibody in the pathogenesis of leprosy and other mycobacterial diseases is not known.

In the present study, we have identified natural antibody to *M. leprae* in nonimmune serum and studied its role in C3 fixation and hence phagocytosis of *M. leprae* by human mononuclear phagocytes. We report that very low levels of immunoglobulin (IgG and IgM) in nonimmune serum are required for C3 fixation to *M. leprae*, which fixes C3 by both the classical and the alternative complement pathways. Such antibody is also required for C1q binding to purified PGL-1, which fixes C3 exclusively by the classical complement

* Corresponding author. Mailing address: Division of Infectious Diseases, Department of Medicine, UCLA School of Medicine, 10833 Le Conte Ave., Los Angeles, CA 90024-1688.

† Present address: Division of Infectious Diseases, Department of Medicine, The University of Iowa College of Medicine, Iowa City, IA 52242.

pathway. By allowing for C3 deposition, natural antibody mediates phagocytosis of *M. leprae*, thus enabling this intracellular pathogen to gain access to its intracellular niche in mononuclear phagocytes.

(This work was presented in part at the 1991 National Meeting of the American Society for Clinical Investigation, American Federation for Clinical Research, and the Association of American Physicians in Seattle, Wash., 3 to 6 May 1991.)

MATERIALS AND METHODS

Abbreviations used in this paper. ELISA, enzyme-linked immunosorbent assay; EGTA, ethylene glycol-bis(β -aminoethyl ether)-*N,N,N',N'*-tetraacetic acid; HI serum, heat-inactivated serum; HSA, human serum albumin; LAM, lipoarabinomannan; LM, lipomannan; $MgCl_2$, magnesium chloride; N_2 , nitrogen; PBS, Dulbecco's phosphate-buffered saline with Ca^{2+} and Mg^{2+} ions; PGL-1, phenolic glycolipid 1; HRP, horseradish peroxidase; MAb, monoclonal antibody; SDS, sodium dodecyl sulfate; SD, standard deviation; SEM, standard error of the mean; BSA, bovine serum albumin.

***M. leprae* and *M. leprae* components.** Armadillo-derived *M. leprae* was purified and handled as previously described (13). Two different preparations of *M. leprae* were used in these studies. *M. leprae* and purified *M. leprae* surface carbohydrates PGL-1 (4), LAM (5), LM (5), and arabinogalactan (7) were kindly provided by Patrick Brennan (Colorado State University, Fort Collins) through contract NO1-AI-05074 from the National Institute of Allergy and Infectious Diseases.

Sera. Serum from four healthy adult volunteers who were purified protein derivative (PPD) negative and had no known exposure to patients with leprosy or travel to leprosy-endemic areas (nonimmune serum) was obtained as previously described (13). Each experiment was performed by using serum from a single donor and repeated at least once with a different donor. Sera from different donors yielded similar results. *M. leprae*-adsorbed serum was prepared by incubating 1 ml of 10% nonimmune serum three times with 10^9 irradiated *M. leprae* for 1 h at 4°C and pelleting the organisms by centrifugation ($14,000 \times g$ for 5 min at 4°C). The adsorbed serum was filtered through a 0.2- μ m-pore-size filter. Factor B-depleted serum and HI serum were prepared from nonimmune serum as previously described (13). Agammaglobulinemic serum was kindly provided by Richard Steihm, Department of Pediatrics, UCLA Medical Center. IgG and IgM in this serum were not detected by a radial immunodiffusion assay. C1q-depleted serum (C1q removed by affinity chromatography) was purchased from Quidel (San Diego, Calif.) and was functional in a standard hemolytic activity assay performed by the company.

Complement proteins, immunoglobulins, and antibodies. C1q (250,000 C1q H50 U/mg in a standard hemolytic activity assay) and factor B (1 U/ μ l restores full hemolytic activity in a standard hemolytic activity assay) were purchased from Quidel. C3 was purchased from Diamedix, Miami, Fla. Purified IgM, IgG, and IgG Fc fragments containing the C1q binding site were purchased from Cappel Research Products, Durham, N.C. For ^{125}I -IgG binding studies, unlabelled IgG was purchased from Zymed Laboratories, Inc., South San Francisco, Calif. ^{125}I -human IgG was purchased from New England Nuclear, Boston, Mass. Specific activities of the preparations of ^{125}I -IgG used ranged from 3.4 to 4.2 μ Ci/ μ g. Chicken anti-human C3 (Accurate Chemical and

Scientific Co., Westbury, N.Y.) diluted 1:10,000; HRP-conjugated human absorbed goat anti-chicken IgG (Bethyl Laboratories, Inc., Montgomery, Tex.) diluted 1:5,000; affinity-purified HRP-conjugated goat anti-human IgG and affinity purified HRP-conjugated goat anti-human IgM (Cappel) diluted 1:1,000; mouse MAb to C1q (Quidel) diluted 1:3,000; and HRP-conjugated goat anti-mouse IgG (Bio-Rad, Richmond, Calif.) diluted 1:3,000 were used in ELISA studies. Mouse MAb against PGL-1 (ML8B2) (8) was kindly provided by P. Brennan.

ELISA to detect complement components and immunoglobulin on the surface of *M. leprae*. *M. leprae* (10^8 bacteria per ml) was incubated with various serum preparations at 37°C for 30 min, harvested by centrifugation at $12,000 \times g$ for 10 min at 4°C, washed vigorously, and resuspended in PBS. Bacteria (10^7) were dispensed into triplicate wells of a 96-well tissue culture plate and allowed to evaporate to dryness under a laminar flow hood (24 to 36 h) (13). Wells were blocked with 3% ovalbumin in PBS for 12 to 18 h and washed. For detection of C3 or C1q, wells were incubated with the appropriate primary antibody (chicken anti-human C3 or MAb to C1q) in 0.3% ovalbumin in PBS at 24°C for 3 h, washed again, and then incubated with the appropriate secondary antibody in 0.3% ovalbumin in PBS for 2 h. For detection of immunoglobulin, wells were incubated only with HRP-conjugated anti-human immunoglobulin. The wells were washed and incubated with HRP substrate (Bio-Rad) for 10 min, and the reaction was terminated by the addition of oxalic acid (1% final concentration). The A_{405} was measured. The absorbance values of control wells devoid of antigen (optical density, typically ≤ 0.10) were subtracted out in each case.

Standard curves for IgG, IgM, C1q, and C3 were generated by drying known quantities of these proteins (diluted in PBS) in triplicate wells of a 96-well tissue culture plate, blocking the wells with 3% ovalbumin in PBS for 12 to 18 h, washing the wells, and detecting the proteins with the appropriate antibodies exactly as described above. Detection was linear for protein quantities of ≥ 10 ng.

Each type of ELISA was performed a minimum of two times. The mean (\pm SD) absorbance for triplicate wells was calculated. In Results, representative figures are shown.

ELISA to detect complement components or immunoglobulin bound to PGL-1 and other *M. leprae* carbohydrates. Duplicate wells were coated with 4.5 μ g of PGL-1, LM, LAM, or arabinogalactan as previously described (15). Wells were blocked with 5.0% HSA (catalog number 126658; Calbiochem Corp., La Jolla, Calif.) in PBS for 2 h at 37°C; washed; incubated with various serum preparations, antibody preparations, purified C1q, or 0.5% HSA (control buffer) for 30 min at 37°C; and washed again. For detection of C3 or C1q, wells were incubated with the appropriate primary antibody (chicken anti-human C3 or MAb to C1q) in 0.5% HSA in PBS (overnight at 4°C), washed, incubated with the appropriate HRP-conjugated secondary antibody in 0.5% HSA in PBS (2 h at 24°C), washed, and incubated with HRP substrate (Bio-Rad) for 10 min. For detection of immunoglobulin, wells were incubated overnight with only HRP-conjugated anti-human immunoglobulin. The reaction was terminated by oxalic acid, and absorbances were measured and analyzed as described above. The optical densities of control wells (all ≤ 0.10), devoid of antigen and/or serum, were subtracted out in each case.

In certain experiments, after incubation with serum, the wells were treated with glycine-HCl containing 0.3 M NaCl, pH 2.5 (four washes, 5 min each, at 4°C) to elute antibody

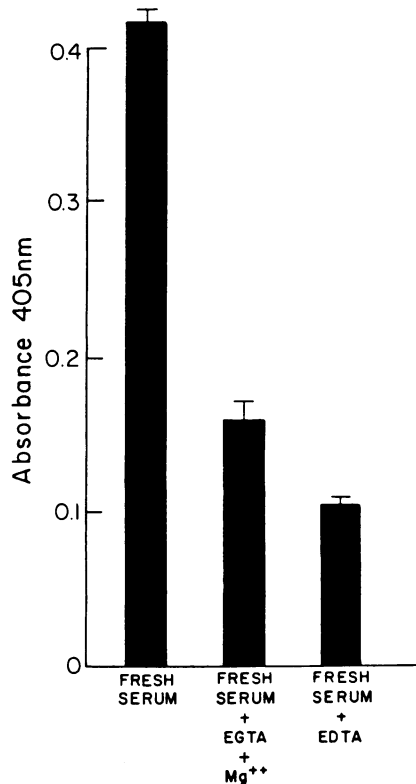

FIG. 1. *M. leprae* fixes complement component C3 by the alternative and classical complement pathways in low serum concentrations. *M. leprae* were incubated in 2.5% fresh nonimmune serum, in 2.5% nonimmune serum containing 10 mM EGTA and 7 mM MgCl₂, or in 2.5% nonimmune serum containing 10 mM EDTA. The bacteria were washed and assayed for associated human C3 by ELISA. In this and subsequent figures, results of one representative experiment are shown.

from the wells. Control experiments demonstrated that antibody was efficiently eluted from antigen-antibody complexes under the conditions of the acid wash. In other experiments, after incubation with serum, the wells were treated with 1 M hydroxylamine in 0.02% SDS (pH 10.0; 60 min at 37°C) to disrupt ester bonds and elute any C3 bound via ester linkage (6). The wells were then incubated with primary and secondary antibodies as described above.

Each type of ELISA was performed a minimum of two times. The mean (\pm SD) absorbance for duplicate wells was calculated.

¹²⁵I-IgG binding to *M. leprae*. Polypropylene tubes (1.8 ml) containing 1 ml of 10% nonimmune serum were rotated overnight at 4°C to block nonspecific protein binding sites. IgG binding to *M. leprae* was then assessed by two types of experiments. In the first type, 6.5×10^7 *M. leprae* cells were suspended in increasing amounts of ¹²⁵I-IgG, ranging from 4 to 500 ng diluted in 0.01% HSA to a final volume of 100 μ l in duplicate tubes. Control tubes contained ¹²⁵I-IgG only. The tubes were placed on a Adams nutator (Clay Adams, Parsippany, N.J.) overnight at 4°C. The bacteria were pelleted by centrifugation, washed six times with 0.01% HSA, resuspended in 100 μ l of 0.01% HSA, and transferred to polystyrene tubes (12 by 75 mm; Falcon 2054; Becton Dickinson Immunocytometry Systems, Mountain View, Calif.). Con-

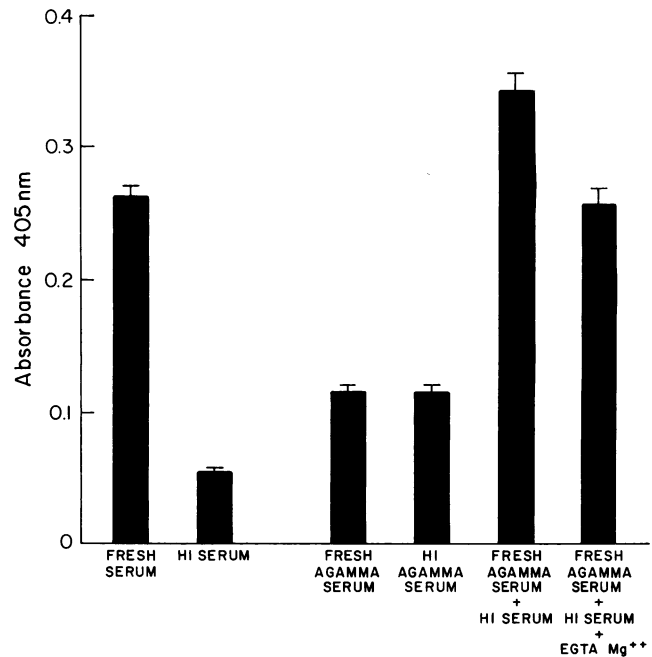

FIG. 2. C3 fixation to *M. leprae* is antibody dependent. *M. leprae* cells were incubated in 10% fresh or HI nonimmune serum, in 10% fresh or HI agammaglobulinemic (AGAMMA) serum, or in 10% fresh agammaglobulinemic serum plus 10% HI serum (source of antibody) with or without EGTA-MgCl₂. The bacteria were then washed and assayed for associated human C3 by ELISA.

trol tubes were washed similarly, 100 μ l of 0.01% HSA was added to them, and the medium was transferred to polystyrene tubes (12 by 75 mm). ¹²⁵I-IgG was counted on a gamma counter with a counting efficiency of 50% for ¹²⁵I-IgG (Beckman Biogamma II; Beckman Instruments, Inc., Fullerton, Calif.). Each tube was counted for 2 min. The counts in control tubes were $\leq 10\%$ of the counts in tubes containing bacteria. The amount of IgG bound to bacteria was calculated by using the specific activity for the preparation of ¹²⁵I-IgG used.

In the second type of experiment, 6.5×10^7 *M. leprae* cells were mixed with a fixed amount of ¹²⁵I-IgG (500 ng) and increasing amounts of unlabeled IgG (2- to 250-fold excess) diluted in 0.01% HSA to a final volume of 200 μ l in duplicate tubes. The tubes were processed and analyzed as described above. In all binding experiments utilizing radiolabelled IgG, ¹²⁵I-IgG and unlabelled IgG were precleared (50,000 $\times g$ for 25 min, repeated once) to remove aggregates.

RESULTS

Both the classical and the alternative complement pathways mediate C3 fixation to *M. leprae* in nonimmune serum; in 2.5% serum, the classical pathway is dominant. In a previous study, we determined that phagocytosis of *M. leprae* by human mononuclear phagocytes is serum dependent and maximal at serum concentrations of $\geq 2.5\%$ (13). In that study, we assayed C3 fixation to *M. leprae* at a high serum concentration within that range, 50%, and found that it was mediated almost entirely by the alternative complement pathway. Since the function of the alternative pathway is diminished at low serum concentrations (9), in this study we

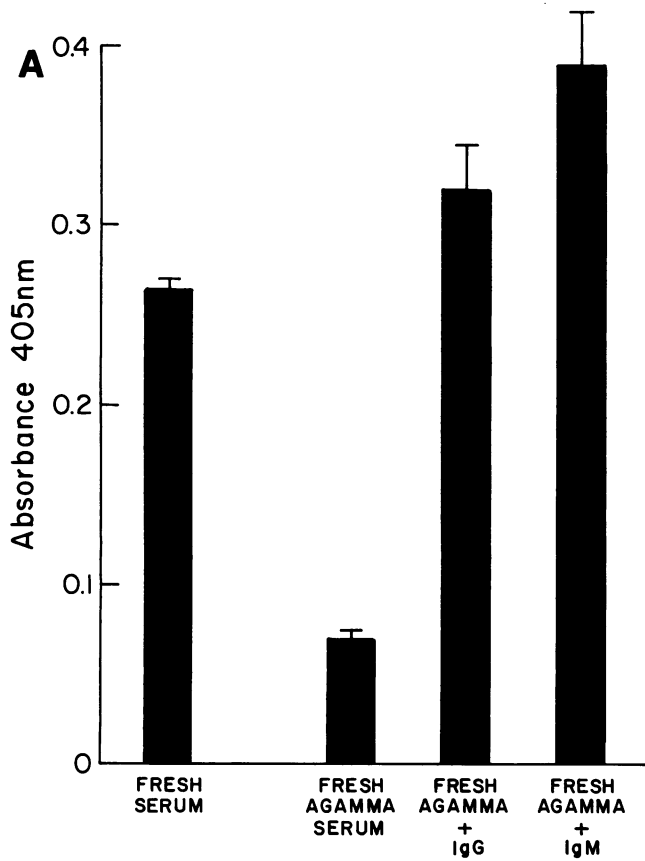
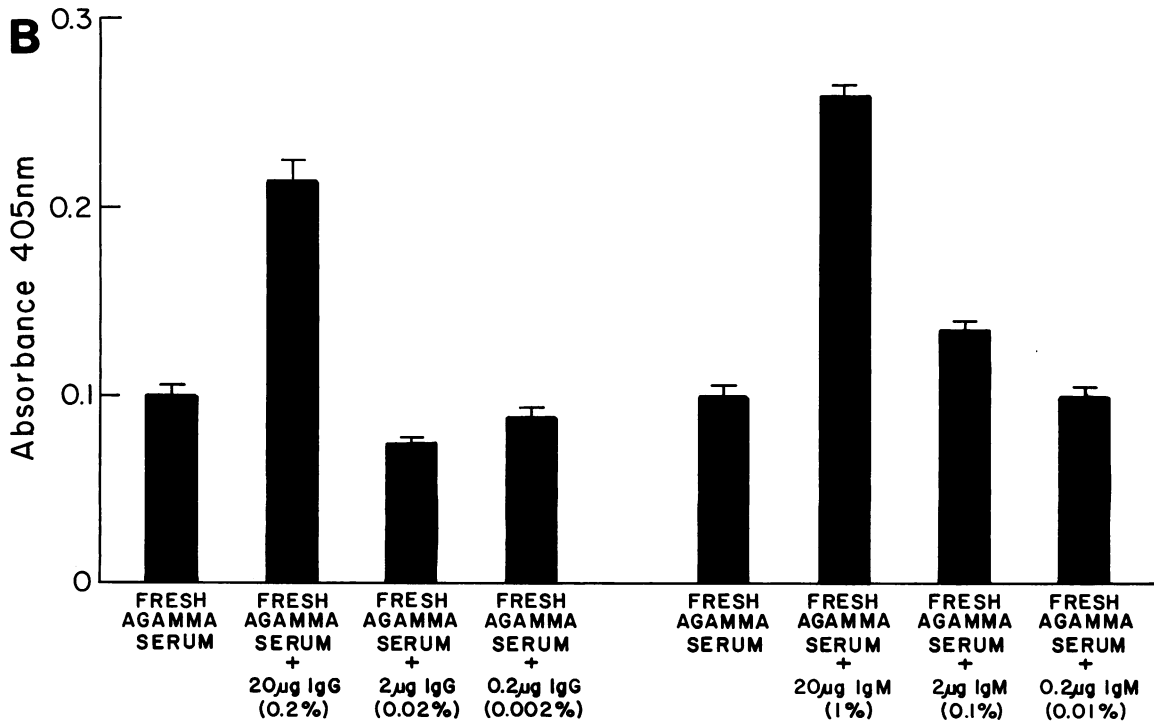

FIG. 3. C3 fixation to *M. leprae* is mediated by very small amounts of IgG or IgM. *M. leprae* cells were incubated in 10% fresh nonimmune serum or in 10% fresh agammaglobulinemic (A-GAMMA) serum with or without pure IgG or pure IgM in an amount equivalent to that in 10% serum (A) or in the amounts indicated (B). The approximate concentration of serum containing the indicated amount of IgG or IgM is shown in parentheses in panel B. The bacteria were then assayed for associated human C3 by ELISA.



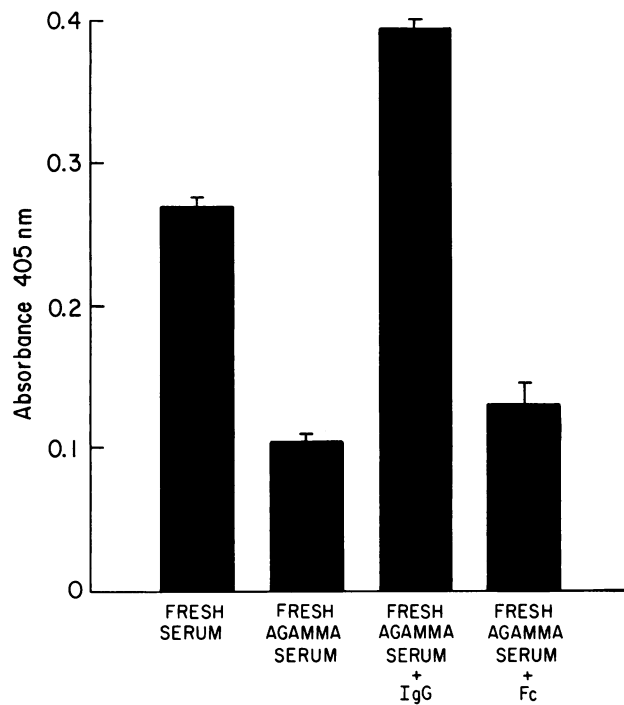

FIG. 4. C3 fixation to *M. leprae* is dependent on the presence of the antigen-binding portion of the antibody molecule. *M. leprae* cells were incubated in 5% fresh nonimmune serum or in 5% fresh agammaglobulinemic (AGAMMA) serum with or without pure IgG (300 μ g) or pure Fc fragments of IgG (100 μ g, molar equivalent). The bacteria were then assayed for associated human C3.

reanalyzed the relative roles of the classical and alternative complement pathways in C3 fixation to *M. leprae* at serum concentrations that were (2.5 to 10%) but that were still within the range yielding maximal phagocytosis. At these concentrations, we found that both the classical and the alternative complement pathways play a major role in C3 fixation, and at the lower end of this serum concentration range, 2.5%, the classical pathway is dominant (Fig. 1). Thus, in 2.5% serum, C3 fixation is markedly reduced by selective inactivation of the classical pathway with EGTA

and Mg^{2+} under conditions that we have previously determined essentially abolish C3 fixation to IgG-coated sheep erythrocytes (12). However, C3 fixation in 2.5% serum is not reduced to the background levels obtained by inactivation of both the classical and the alternative pathways with EDTA (Fig. 1). Consistent with a role for the classical pathway in C3 fixation in 2.5% serum, the addition of pure classical pathway component C1q to C1q-depleted serum significantly increased the level of C3 fixed to *M. leprae* (3.8- \pm 0.9-fold increase [mean \pm SEM], $n = 3$). Consistent with a role for the alternative pathway in C3 fixation in 2.5% serum, the addition of pure factor B to factor B-depleted serum significantly increased the level of C3 fixed to *M. leprae* (3.2- \pm 0.2-fold increase [mean \pm SEM], $n = 2$).

Thus, within the range of serum concentrations that yield maximal phagocytosis of *M. leprae*, components of both the classical and the alternative complement pathways mediate C3 fixation to *M. leprae*. At the high end of this range, the alternative pathway predominates, whereas at the low end of this range, the classical pathway predominates.

C3 fixation to *M. leprae* is strictly antibody dependent. To determine the role of natural antibody in C3 fixation to *M. leprae*, we studied C3 fixation in normal and agammaglobulinemic nonimmune serum. We chose to use 10% serum for these studies, since at this concentration both the classical and the alternative complement pathways are functionally active and play significant roles in C3 fixation to *M. leprae* (Fig. 2). *M. leprae* fixed C3 in nonimmune serum but not in agammaglobulinemic serum, unless HI nonimmune serum as a source of antibody (Fig. 2) or pure IgG or IgM (Fig. 3) was added. Antibody mediated C3 fixation by both the alternative and the classical complement pathways since, in the presence of a source of antibody, a substantial amount of C3 fixed to *M. leprae* under conditions in which only the alternative pathway was functional (EGTA- Mg^{2+}), but not as much as when both pathways were functional (Fig. 2). C3 fixation required very small amounts of antibody, since IgG in an amount equivalent to that in 0.2% serum or IgM in an amount equivalent to that in 0.1% serum mediated detectable C3 fixation to *M. leprae* (Fig. 3B). C3 fixation required the antigen-binding portion of the antibody molecule, since an equivalent amount of pure Fc fragments of immunoglobulin did not mediate C3 fixation to *M. leprae* in agammaglobulinemic serum (Fig. 4). Adsorption of nonimmune serum with *M. leprae* led to a consistent decrease in subsequent C3 fixation to *M. leprae* that returned to baseline with the addition of IgM (Table 1).

The requirement for antibody for C3 fixation to *M. leprae* by both the alternative and the classical complement pathways prompted us to assay the levels of antibody and selected complement components on the surface of *M. leprae* after incubation in nonimmune serum. IgG, IgM, and C1q in nonimmune serum bound to the surface of *M. leprae* in a linear fashion over a serum concentration range of 2.5 to 40% (Fig. 5). By using standard curves for IgG, IgM, and C1q generated by plotting absorbance against known quantities of these proteins bound to ELISA wells, we calculated that 271 IgG, 4 IgM, and 11 C1q molecules were bound per bacillus on average in 2.5% serum. In contrast to IgG, IgM, and C1q binding, C3 binding was near maximal in 2.5% serum (Fig. 5). Using a standard curve for C3, we calculated that approximately 1,000 C3 molecules were bound per bacillus on average in 2.5% serum. To evaluate further the above results for IgG, the most abundant immunoglobulin bound, we measured the binding of ^{125}I -IgG to *M. leprae* in solution over 24 h (steady-state conditions). These studies

TABLE 1. C3 fixation to *M. leprae* is decreased in adsorbed serum^a

Expt and condition	C3 bound (OD units [mean \pm SD])
A	
Fresh serum.....	0.28 \pm 0.02
Adsorbed serum	0.18 \pm 0.001
Adsorbed serum + IgM	0.29 \pm 0.008
B	
Fresh serum.....	0.38 \pm 0.005
Adsorbed serum	0.23 \pm 0.01
Adsorbed serum + IgM	0.44 \pm 0.02

^a In two independent experiments, *M. leprae* cells were incubated in 5% fresh nonimmune serum, in 5% fresh nonimmune serum that had been adsorbed with irradiated *M. leprae*, or in 5% adsorbed serum to which 169 μ g of IgM (amount equivalent to that in 5% serum) per ml was added. The bacteria were then washed and assayed for associated human C3. OD, optical density.

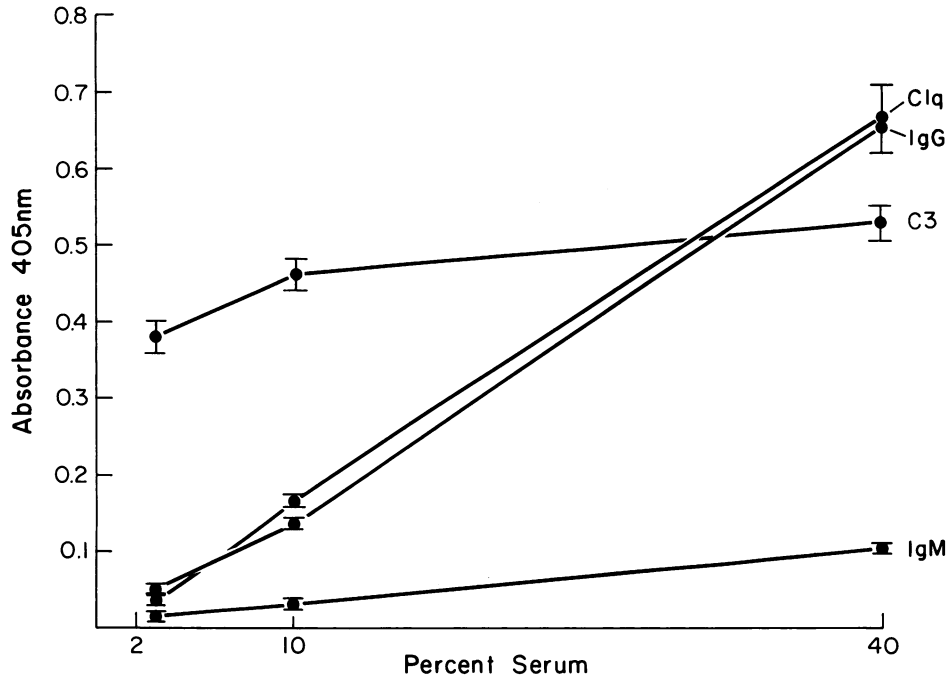

FIG. 5. C3, C1q, IgG, and IgM in nonimmune serum bind to the surface of *M. leprae*. *M. leprae* cells were incubated in fresh nonimmune serum at the concentrations indicated. The bacteria were then assayed for bound C3, C1q, IgG, or IgM.

yielded results of the same order of magnitude as the ELISA results in which IgG binding was measured over 30 min. We calculated 990 ± 146 (SEM, $n = 3$) IgG molecules were bound per bacillus on average at an IgG concentration of 440

$\mu\text{g/ml}$, a concentration roughly equivalent to that in 2.5% serum. Both types of ^{125}I -IgG labelling experiments described in Materials and Methods yielded similar results.

Classical complement pathway activation by PGL-1 leads to C1q deposition and is antibody dependent. We have previously determined that PGL-1 is the C3 acceptor molecule on the surface of *M. leprae* and that C3 fixation to this glycolipid is mediated by the classical complement pathway (15). To determine the role of C1q in classical pathway activation by PGL-1, we studied C1q binding to PGL-1 by ELISA. Consistent with activation of the classical pathway by PGL-1, C1q bound to PGL-1 in a serum concentration-dependent manner (Fig. 6). Significant C1q binding was evident in $\geq 1.25\%$ nonimmune serum.

We next explored the role of natural antibody in C1q fixation to PGL-1. When PGL-1 was incubated with pure C1q, little or no C1q bound to PGL-1 unless HI nonimmune serum, as a source of antibody, or pure IgG and IgM were added (Fig. 7). These results indicated that PGL-1 binds antibody in nonimmune serum, and this leads to deposition of the first component of the classical complement pathway: C1q.

C3 is covalently bound by ester linkage to PGL-1 and not appreciably to anti-PGL-1 antibody. The requirement of antibody for C3 fixation to *M. leprae* and for C1q binding to PGL-1 suggested the possibility that anti-PGL-1 antibody serves as a major acceptor molecule for C3. To explore this possibility, we allowed PGL-1 to fix C3 in nonimmune serum, washed the wells with acid buffer under conditions that completely eluted antibody or with control buffer, and assayed acid-washed and control wells for C3. C3 fixation to PGL-1 was not reduced by acid elution of anti-PGL-1 antibody, (mean percent reduction in optical density \pm SEM after acid washing, 5 ± 2 ; $n = 2$), indicating that activated C3 fragments are bound directly to PGL-1 and not to antibody to any appreciable extent.

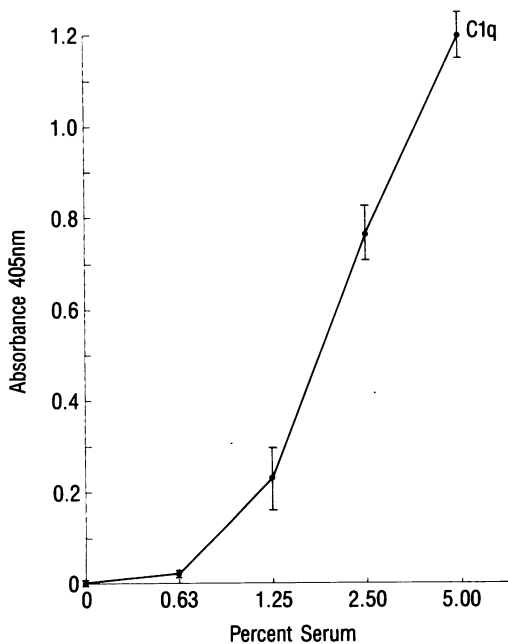

FIG. 6. C1q in nonimmune serum binds to PGL-1 in a serum concentration-dependent manner. PGL-1 was adhered to ELISA plate wells and incubated in fresh nonimmune serum at the concentrations indicated. The wells were washed and assayed for associated human C1q.

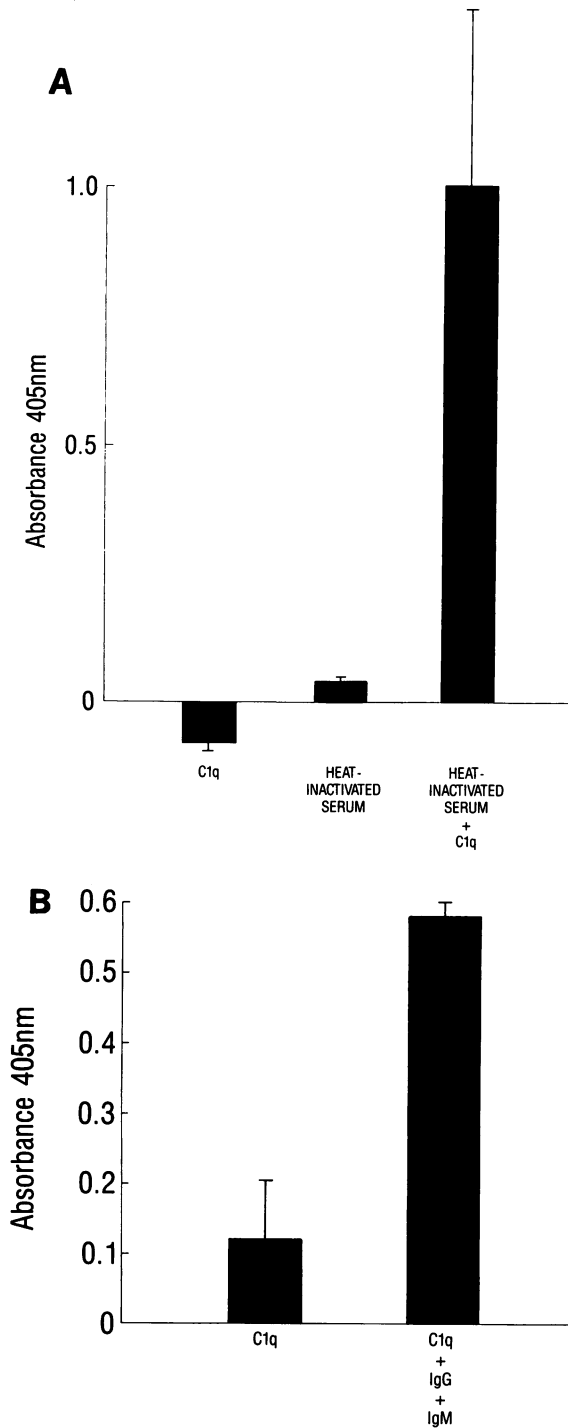

FIG. 7. C1q binding to PGL-1 is mediated by IgG and IgM. PGL-1 was adhered to ELISA plate wells and incubated with pure C1q (5 μ g), 5% HI serum, or both C1q and HI serum (A) or with pure C1q (5 μ g) with or without IgG (90 μ g) and IgM (20 μ g) (B). The wells were washed and assayed for associated human C1q.

In a previous study (15), we demonstrated that C3 fixation to PGL-1 is strictly dependent on the terminal trisaccharide of the molecule. Sequential removal of sugars from PGL-1 (or a surrogate molecule) results in a stepwise reduction in

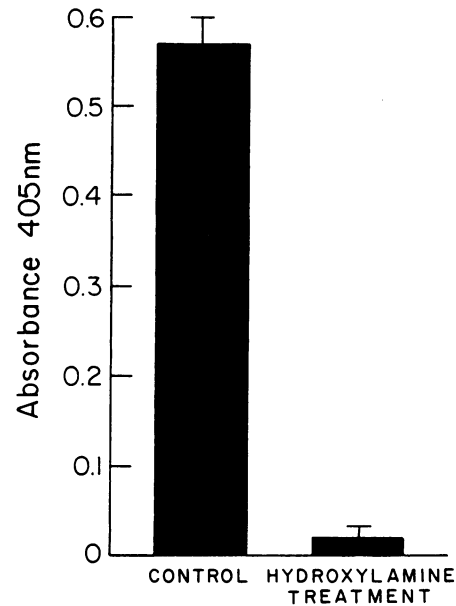

FIG. 8. C3 fixation to PGL-1 is significantly reduced by hydroxylamine treatment. PGL-1 was adhered to ELISA plate wells and incubated with 2.5% fresh nonimmune serum. The wells were then treated with 1 M hydroxylamine in SDS (pH 10.0) for 60 min or with SDS alone (control wells) and assayed for associated human C3.

C3 fixation; removal of all three sugar moieties abolishes C3 fixation. These results prompted us to hypothesize that C3 is covalently bound by ester bonds to hydroxyl groups on the trisaccharide portion of PGL-1, as these are the only groups on the molecule available to form a covalent bond with C3. To test this hypothesis, we assayed the amount of C3 bound to PGL-1 before and after disruption of ester bonds by hydroxylamine treatment. Disruption of ester bonds by hydroxylamine treatment reduced the amount of C3 bound to PGL-1 by more than 1 log unit (Fig. 8). PGL-1 binding, assayed with a MAb to PGL-1, was not affected by hydroxylamine treatment (data not shown). These results supported the hypothesis that C3 binds to hydroxyl groups on the trisaccharide of PGL-1 via ester bonds.

Nonimmune serum contains natural antibody to PGL-1, LM, LAM, and arabinogalactan. To determine which major *M. leprae* surface carbohydrates are recognized by natural antibody, we assayed antibody to PGL-1, LM, LAM, and arabinogalactan in nonimmune serum. Nonimmune serum contained IgG and IgM antibodies to all four *M. leprae* surface molecules (Fig. 9). IgG and IgM antibodies to PGL-1 were barely detected under the stringent conditions of this assay. Significantly more IgM antibody to LM than to PGL-1 was detected, but the amount was relatively small. Relatively large amounts of both IgG and IgM to LAM and arabinogalactan were detected.

DISCUSSION

In previous studies, we have demonstrated that phagocytosis of *M. leprae* by human mononuclear phagocytes is mediated by a three-component receptor-ligand-acceptor molecule system consisting of phagocyte complement receptors, C3 fragments recognized by these receptors, and PGL-1, the C3 acceptor molecule on the surface of *M. leprae*. In the present study, we extend these observations

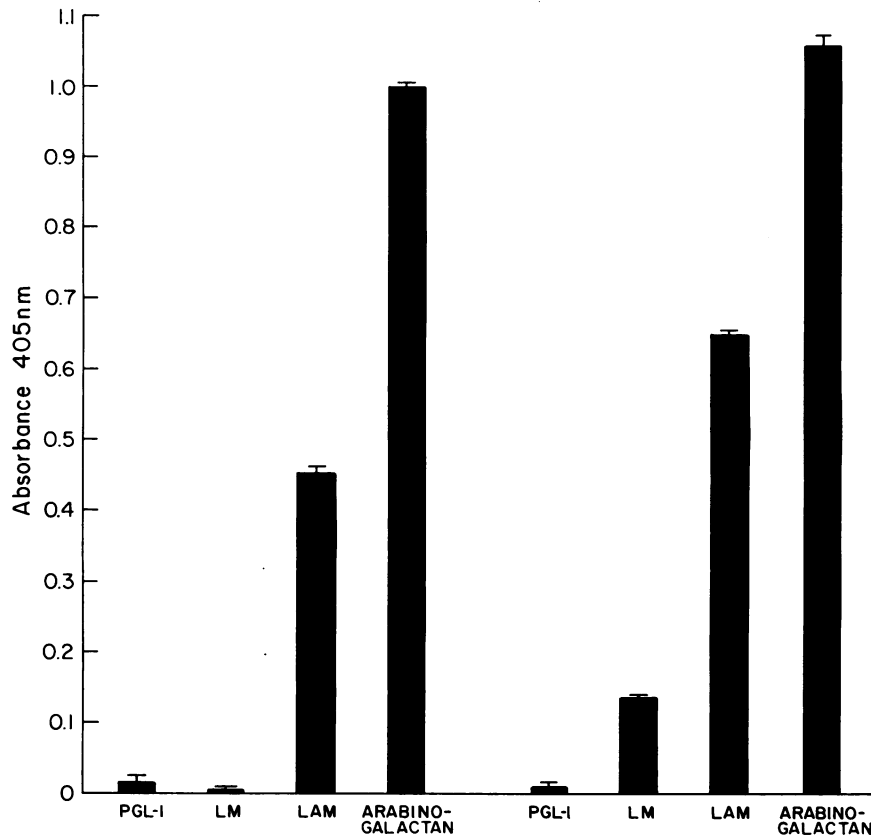

FIG. 9. Antibody in nonimmune serum binds to PGL-1, LM, LAM, and arabinogalactan. PGL-1, LM, LAM, or arabinogalactan was adhered to ELISA plate wells, incubated in 20% fresh nonimmune serum containing 10 mM EDTA, and assayed for associated human IgG or human IgM.

by showing that antibody in nonimmune serum, so-called natural antibody, mediates C3 fixation to the bacterial surface. Natural antibody is required for C1q binding to PGL-1 and C3 fixation to *M. leprae* by the classical complement pathway and also for C3 fixation to *M. leprae* by the alternative complement pathway (Fig. 10). A role for natural antibody in augmenting C3 fixation through the alternative pathway has been shown for other microbes, including mycobacteria (10, 17).

Our study demonstrates that nonimmune serum contains antibody that binds to the *M. leprae* surface in an immunologically relevant fashion. Antibodies to PGL-1, LM, LAM, and arabinogalactan were detected by ELISA. Interestingly, much less antibody was present in nonimmune serum to PGL-1 than to the other surface carbohydrates of *M. leprae*, and yet only PGL-1 fixes appreciable amounts of C3 (15). This underscores the selective role of PGL-1 as a C3 acceptor molecule on the *M. leprae* surface. Although the other *M. leprae* surface carbohydrates do not serve as major acceptor molecules for C3, these carbohydrates and the natural antibodies to them may nevertheless play a role in complement activation by the intact organism. Along these lines, in preliminary studies, we have found that when PGL-1 is incubated in 2.5% nonimmune serum in combination with LAM rather than alone, the alternative pathway plays a more important role in mediating C3 fixation to PGL-1 (unpublished data). The precise nature of the anti-

bodies that mediate C3 fixation in the present study, including their subtypes and the epitopes they recognize, are unknown and await further studies.

Our studies indicate that very few immunoglobulin molecules are required for C3 fixation—on the order of 10^2 to 10^3 IgG molecules or 10^0 to 10^1 IgM molecules—and the antigen-binding portion of the molecule is essential. While our whole bacterial cell ELISA was a highly sensitive and quantifiable technique, we view values for the number of immunoglobulin and C3 molecules bound per bacterium as approximations. Two sources of inaccuracies bear mention. First, our calculations assumed that all bacteria that we added to wells remained adherent throughout the assay. Any losses of bacteria would have resulted in an underestimation of immunoglobulin and C3 molecules bound per bacterium. However, the very small standard deviations in our data from triplicate wells argue against any such presumably random losses of bacteria during the assay. Second, immunoglobulin and C3 bound on the underside of the bacteria may not have been accessible to anti-immunoglobulin and anti-C3 antibodies. This too would have resulted in an underestimation of the number of immunoglobulin and C3 molecules bound. However, the experiments using ^{125}I -IgG with bacteria in solution yielded results for IgG binding that were somewhat higher but of the same order of magnitude as the ELISA results, suggesting that the ELISA was reasonably accurate. The somewhat higher reading for IgG binding per bacterium

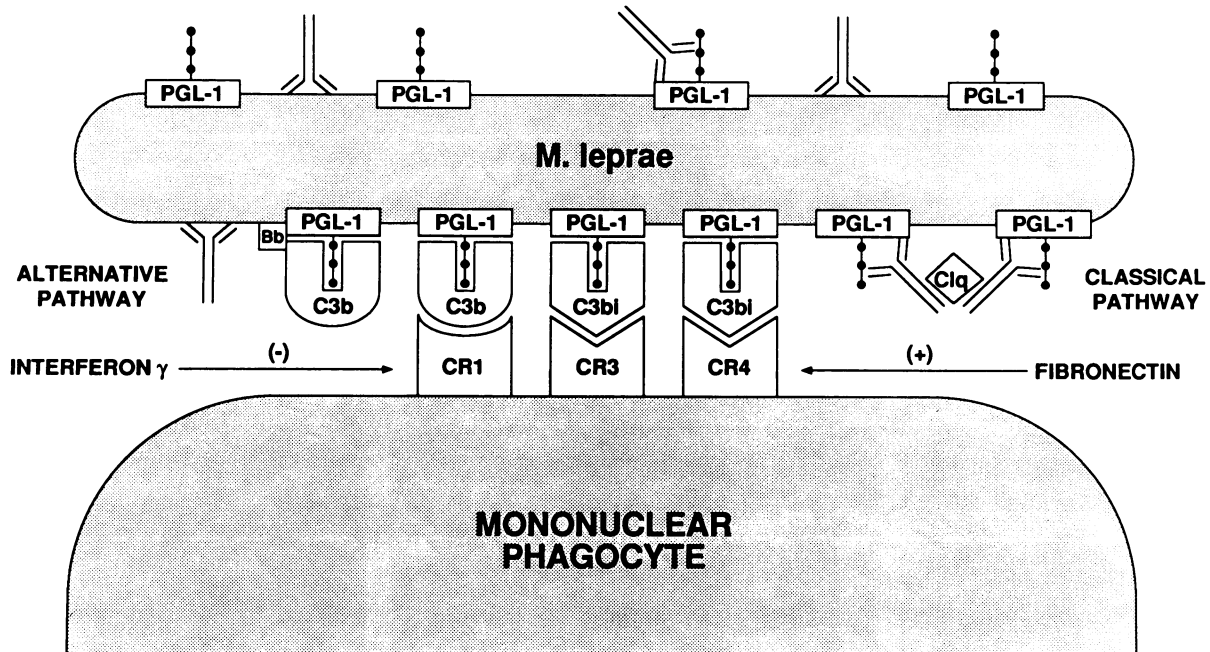

FIG. 10. Phagocytosis of *M. leprae* is mediated by a three-component phagocytic system consisting of (i) complement receptors on the surface of mononuclear phagocytes (CR1 and CR3 on human monocytes and CR1, CR3, and CR4 on human macrophages); (ii) fragments of complement component C3 (C3b and C3bi); and (iii) PGL-1 on the *M. leprae* surface (13–15). C3 fixation to PGL-1 is mediated by both the classical and the alternative complement pathways. C3 fixation by both pathways is strictly antibody dependent, and in nonimmune serum, natural antibody mediates C3 fixation. PGL-1, an abundant surface glycolipid, fixes C3 to its terminal trisaccharide via covalent ester bonds (15). Gamma interferon activation of human macrophages decreases *M. leprae* phagocytosis by down-regulating complement receptor number (CR1) and function (CR3 and CR4) (14). Maximal complement receptor-mediated phagocytosis of *M. leprae* requires the presence of fibronectin (14). ;, terminal trisaccharide of PGL-1.

obtained in the ^{125}I -IgG assay likely reflected the underestimations of the ELISA just noted and the fact that the assay measured IgG binding over 24 h (steady-state conditions) versus over 30 min in the ELISA.

Although natural antibody in very small amounts plays an essential role in mediating C3 fixation to *M. leprae* and consequently phagocytosis of the bacterium via complement receptors, antibody does not appear to play a major role in mediating phagocytosis of *M. leprae* via Fc receptors. In a previous study, we found that downmodulation of Fc receptors on monocytes resulted in only a small reduction in phagocytosis of *M. leprae* (13).

Our study shows that the classical complement pathway dominates C3 fixation to *M. leprae* in serum concentrations at the low end (2.5%) of the range at which phagocytosis is maximal. In contrast, the alternative complement pathway dominates C3 fixation to *M. leprae* at high serum concentrations. The concentrations of serum proteins including complement that are available to opsonize *M. leprae* in the tissues are unknown. Possibly, studies using low concentrations of serum more closely reflect the situation in the tissues than studies using high concentrations of serum.

Natural antibodies to other species of mycobacteria have frequently been observed. In the case of *Mycobacterium tuberculosis*, several early studies demonstrated a high frequency of both IgG and IgM anti-*M. tuberculosis* antibody in the sera of normal subjects (purified protein derivative negative and without a history of *M. tuberculosis* infection), suggesting that most persons have been sensitized to *M.*

tuberculosis antigens during their lifetime (1). Such sensitization may have resulted from exposure to saprophytic and/or avirulent mycobacteria or other bacterial species that share antigenic components with *M. tuberculosis* (1). Cross-reactive antibodies often have led to false-positive results in a variety of systems designed to evaluate antibody responses to *M. tuberculosis* antigens.

In our study, adsorption of nonimmune serum resulted in a consistent decrease in C3 fixation to *M. leprae*, a decrease that was restored with purified IgM. However, adsorption of serum did not reduce C3 fixation to the baseline levels observed with agammaglobulinemic serum. That adsorption did not lead to a more complete reduction in C3 fixation likely reflected incomplete adsorption of antibody, since even after three adsorptions with 10^9 organisms, human immunoglobulin was still present on the organisms used for adsorption. Adsorption with larger numbers of organisms may have depleted serum of more antibody, but limitations in the amount of material available precluded this. Also, natural antibody is likely of low affinity to *M. leprae*, and complete adsorption may not be possible.

Recently, Ramanathan et al. demonstrated that PGL-1 consumed complement through both the alternative and the classical pathways independently of antibody but that specific antibody from lepromatous leprosy patients enhanced C3 fixation (11). Their finding that C3 fixation is independent of antibody is in contrast to our findings that C3 fixation to *M. leprae* and C1q binding to PGL-1 is strictly dependent on antibody. This apparent discrepancy may in part be due to

the inability of the assay used by these authors to detect very low levels of residual antibody left in their adsorbed serum. Indeed, we have determined that extremely low levels of antibody (IgG or IgM) can mediate detectable C3 fixation. Also, BSA was used as a blocking agent in their ELISA. We have found that BSA fails to inhibit activation and fixation of C3 by the plastic wells of the ELISA plate. It is possible that immunoglobulin contaminating BSA is responsible for this problem. We have overcome the problem by using highly purified HSA.

Antibody is generally considered in the context of host defense against pathogenic organisms. However, in the case of leprosy and other major mycobacterial infections, e.g., tuberculosis, the humoral immune system is generally thought not to play a role in host defense. Instead, cell-mediated immunity is considered central to host defense against these infections and others caused by intracellular pathogens. To our knowledge, a role for natural antibody in the pathogenesis of major mycobacterial infections has not been considered.

Our study provides evidence for a role for natural antibody in the pathogenesis of leprosy. Our study suggests that very small amounts of IgG and IgM in the serum of a naive host can trigger complement activation and deposition of C3 activation products on the *M. leprae* surface. These activation products serve as major opsonins for phagocytosis of the leprosy bacillus by monocytes and macrophages, the major host cells for *M. leprae*. The amount of natural antibody in a given individual may be influenced by prior exposure to saprophytic mycobacteria or to other pathogens that results in the production of cross-reactive antibody. Thus, predisposition to leprosy may in part be determined by an individual's circulating immunoglobulin repertoire.

Natural antibody may also influence the form of leprosy (tuberculoid versus lepromatous) in an individual. Factors predisposing an individual to a particular polar form of leprosy are not understood. The apparent absence of diversity among *M. leprae* strains (3) suggests that host factors are important. The lack of conclusive evidence in support of a genetic predisposition to a form of leprosy and the fact that identical twins may have different forms of leprosy suggest that nongenetic host factors are important (2). One possibility suggested by this study is that differences in the amount and type of natural antibody in naive individuals exposed to *M. leprae* influence the form of leprosy in these individuals if they later develop disease.

As complement receptors mediate phagocytosis of a diverse group of intracellular pathogens, small amounts of natural antibody may play a general role in disease pathogenesis by intracellular pathogens by influencing C3 deposition and, hence, phagocytosis of these pathogens by appropriate host cells.

ACKNOWLEDGMENTS

We are grateful to Barbara Jane Dillon for her expert technical assistance.

This work was supported by grant AI-25681 from the National Institutes of Health. During the time this work was performed, L. S. Schlesinger was a postdoctoral researcher in Infectious Diseases at UCLA Center for the Health Sciences and a recipient of a National Research Service Award from the National Institutes of Health. M. A. Horwitz is Gordon MacDonald Scholar at the University of California, Los Angeles.

REFERENCES

1. Bardana, E. J., Jr., J. K. McClatchy, R. S. Farr, and P. Minden. 1973. Universal occurrence of antibodies to tubercle bacilli in sera from non-tuberculous and tuberculous individuals. *Clin. Exp. Immunol.* **13**:65-77.
2. Chakravarti, M. R., and F. Vogel. 1973. A twin study on leprosy, p. 1-29. In P. E. Becker, W. Lenz, F. Vogel, and G. G. Went (ed.), *Topics in human genetics*, vol. 1. Thieme, Stuttgart, Germany.
3. Clark-Curtiss, J. E., and G. P. Walsh. 1989. Conservation of genomic sequences among isolates of *Mycobacterium leprae*. *J. Bacteriol.* **171**:4844-4851.
4. Hunter, S. W., T. Fujiwara, and P. J. Brennan. 1982. Structure and antigenicity of the major specific glycolipid antigen of *Mycobacterium leprae*. *J. Biol. Chem.* **257**:15072-15078.
5. Hunter, S. W., H. Gaylord, and P. J. Brennan. 1986. Structure and antigenicity of the phosphorylated lipopolysaccharide antigens from the leprosy and tubercle bacilli. *J. Biol. Chem.* **261**:12345-12351.
6. Law, S. K., N. A. Lichtenberg, and R. P. Levine. 1979. Evidence for an ester linkage between the labile binding site of C3b and receptive surfaces. *J. Immunol.* **123**:1388-1394.
7. McNeil, M., S. J. Wallner, S. W. Hunter, and P. J. Brennan. 1987. Demonstration that the galactosyl and arabinosyl residues in the cell-wall arabinogalactan of *Mycobacterium leprae* and *Mycobacterium tuberculosis* are furanoid. *Carbohydr. Res.* **166**:299-308.
8. Mehre, V., P. J. Brennan, E. Rada, J. Convit, and B. R. Bloom. 1984. Lymphocyte suppression in leprosy induced by unique *M. leprae* glycolipid. *Nature (London)* **308**:194-196.
9. Muller-Eberhard, H. J., and R. D. Schreiber. 1980. Molecular biology and chemistry of the alternative pathway of complement. *Adv. Immunol.* **29**:1-53.
10. Parkash, O., V. D. Ramanathan, D. P. Singh, and U. Sengupta. 1988. Effect of anti-mycobacterial antibodies on activation of the alternative pathway of the human complement system. *FEMS Microbiol. Lett.* **55**:255-258.
11. Ramanathan, V. D., O. Parkash, P. Tyagi, U. Sengupta, and G. Ramu. 1990. Activation of the human complement system by phenolic glycolipid 1 of *Mycobacterium leprae*. *Microb. Pathog.* **8**:403-410.
12. Schlesinger, L. S., C. G. Bellinger-Kawahara, N. R. Payne, and M. A. Horwitz. 1990. Phagocytosis of *Mycobacterium tuberculosis* is mediated by human monocyte complement receptors and complements component C3. *J. Immunol.* **144**:2771-2780.
13. Schlesinger, L. S., and M. A. Horwitz. 1990. Phagocytosis of leprosy bacilli is mediated by complement receptors CR1 and CR3 on human monocytes and complement component C3 in serum. *J. Clin. Invest.* **85**:1304-1314.
14. Schlesinger, L. S., and M. A. Horwitz. 1991. Phagocytosis of *Mycobacterium leprae* by human monocyte-derived macrophages is mediated by complement receptors CR1(CD35), CR3(CD11b/CD18), and CR4(CD11c/CD18) and interferon gamma activation inhibits complement receptor function and phagocytosis of this bacterium. *J. Immunol.* **147**:1983-1994.
15. Schlesinger, L. S., and M. A. Horwitz. 1991. Phenolic glycolipid-1 of *Mycobacterium leprae* binds complement component C3 in serum and mediates phagocytosis by human monocytes. *J. Exp. Med.* **174**:1031-1038.
16. Touw, J., E. M. J. Langendijk, G. L. Stoner, and A. Belehu. 1982. Humoral immunity in leprosy: immunoglobulin G and M antibody responses to *Mycobacterium leprae* in relation to various disease patterns. *Infect. Immun.* **36**:885-892.
17. Winkelstein, J. A., H. S. Shin, and W. B. Wood, Jr. 1972. Heat labile opsonins to *Pneumococcus*. III. The participation of immunoglobulin and of the alternate pathway of C3 activation. *J. Immunol.* **108**:1681-1689.