

Cyclophilin A Is Required for an Early Step in the Life Cycle of Human Immunodeficiency Virus Type 1 before the Initiation of Reverse Transcription

DOUGLAS BRAATEN,¹ ETTALY KARA FRANKE,² AND JEREMY LUBAN^{1,2*}

Departments of Microbiology¹ and Medicine,² College of Physicians and Surgeons, Columbia University, New York, New York 10032

Received 7 December 1995/Accepted 22 February 1996

Cyclophilin A (CyPA) is incorporated into human immunodeficiency virus type 1 (HIV-1) virions via contact with the Gag polyprotein. Genetic or pharmacologic disruption of CyPA incorporation causes a quantitative reduction in virion infectivity with no discernible effects on virion assembly or on endogenous reverse transcriptase activity. Instead, the reduction of virion-associated CyPA is accompanied by a parallel, quantitative decrease in the initiation of viral DNA synthesis after infection of T cells. The infectivity of CyPA-deficient virions is not restored by pseudotyping with Env of amphotropic murine leukemia virus, demonstrating that CyPA is not required for the HIV-1-Env-CD4 interaction. These results indicate that CyPA is required for an early step in the HIV-1 life cycle following receptor binding and membrane fusion but preceding reverse transcription. CyPA is the first cellular protein other than the cell surface receptor shown to be required for an early event in the life cycle of a retrovirus.

Gag proteins play roles in many steps of the retroviral life cycle. The major gag translation product is a polyprotein which contains information sufficient for the assembly and release of virions (69). The Gag polyprotein specifically incorporates several viral elements into nascent virions, including viral genomic RNA (33), the *env* glycoprotein (14, 70), and the *pol*-encoded enzymes (44, 56). As virions are released from the cell surface, the Gag polyprotein is cleaved by the viral protease to produce the matrix protein (MA), which lines the virion envelope, the capsid protein (CA), which forms the core of the virion, and the nucleocapsid protein (NC), which coats the genomic RNA. Viral protease activation is required for virion infectivity (23, 27, 60) and is itself regulated by the Gag residues to which protease is initially fused (37, 71).

Upon entry into a new host cell, viral genomic RNA serves as a template for the *pol*-encoded reverse transcriptase (RT) (68). The resulting double-stranded DNA is transported to the nucleus, where it is covalently linked to host chromosomal DNA by the viral integrase to form the provirus. Biochemical and genetic data suggest that Gag proteins play important roles during these early events prior to integration. For example, murine leukemia virus (MLV) DNA harvested from cells shortly after the initiation of infection is intimately associated with CA (7). In contrast, the human immunodeficiency virus type 1 (HIV-1) preintegration complex contains MA but no detectable CA (10, 15). HIV-1 MA possesses a nuclear localization signal which targets the preintegration complex to the nucleus via the nuclear pore (9, 19). In addition, a number of gag mutations which have no observable effects upon virion assembly but which disrupt the infectivity of virion particles early in the infectious cycle have been engineered (12, 25, 39, 48, 61, 66).

Cellular proteins might be required for any of the Gag func-

tions described above. Cotranslational modification by the host *N*-myristyl transferase is required for targeting the Gag polyprotein to the cell surface (8, 23, 49, 50), but no other proteins are known to be necessary for Gag polyprotein folding, transport, or assembly into virions. Similarly, nothing is known about host proteins required for Gag function during virion uncoating or nuclear translocation of the preintegration complex. One indication of the importance of an interaction between Gag and a host factor during these early events is provided by the *Fv-1* locus, a genetic element which restricts infection by select murine retroviral strains at a step prior to integration (for a review, see reference 47). Viral sensitivity to *Fv-1* restriction is determined by CA coding sequences, suggesting that the encoded factor attenuates infectivity by disrupting Gag function during these early events.

The Gag polyprotein of HIV-1 binds to cyclophilins (CyPs) (35), a ubiquitous family of proteins that catalyze a rate-limiting step in protein folding (peptidyl-prolyl isomerization) (16, 21), protect cells from heat shock (62), and function as chaperones (3). Cyclophilin A (CyPA), the major cytoplasmic member of the family, is specifically incorporated into HIV-1 virions through interactions with the Gag polyprotein (18, 63). CyPA also binds to HIV-1 CA (35), a Gag polyprotein cleavage product which is not produced until virion release from producer cells. Therefore, if necessary for Gag function, CyPA might function during virion assembly or during early events in the infection cycle.

That CyPA is required for Gag folding or intracellular targeting is suggested by the fact that gag mutations and pharmacologic agents such as cyclosporin A (CsA) disrupt Gag binding to CyPA in vitro, block CyPA incorporation into virions, and inhibit viral replication (4, 18, 26, 51, 63, 65). The dose of CsA required for inhibition of HIV-1 replication is similar to the concentration of CyPA normally found in the cytoplasm (29); this is consistent with a mechanism by which CsA inhibits replication by competing with Gag for CyPA binding. Retroviruses other than HIV-1, including HIV-2 and several simian immunodeficiency virus species, do not encode Gag proteins capable of binding to CyPA; these viruses do not package

* Corresponding author. Mailing address: Departments of Microbiology and Medicine, Columbia University, College of Physicians and Surgeons, 701 W. 168th St., New York, NY 10032. Phone: (212) 305-8706. Fax: (212) 305-8706. Electronic mail address: Luban@cuccfa.ccc.columbia.edu.

CyPA into virions, and the replication of these viruses is not inhibited by CsA (6, 7a, 18, 63). Therefore, CyPA appears to be uniquely required for HIV-1 replication.

Here we demonstrate that CyPA is not required for HIV-1 virion assembly. Intravirion CyPA is instead required for an early step in the retroviral life cycle following receptor binding and membrane fusion but prior to reverse transcription. Thus, CyPA is the first cellular protein shown to be incorporated into retroviral virions and necessary for infectivity; it is also the first cellular factor, other than the cell surface receptor, found to be required for infection of a new host cell.

MATERIALS AND METHODS

Plasmid DNAs, mutagenesis, and recombinant protein. Plasmid DNAs were propagated by standard methods (54). To prevent unwanted deletions, proviral DNAs were propagated in JM109 clone 3226 (Life Technologies, Inc., Gaithersburg, Md.) at 30°C. Supercoiled plasmids were purified with the Plasmid Maxi kit (Qiagen, Chatsworth, Calif.).

The HIV-1 Gag polyprotein bacterial expression plasmid pT7HG(pro-) has been described previously (36). Human CyPA and CyPB were expressed in bacteria by using previously described glutathione *S*-transferase (GST) fusion protein expression constructs (35). Recombinant proteins expressed from the above-mentioned plasmids were produced and used in binding assays as previously described (35).

pNL4-3 is a plasmid containing a complete infectious clone of HIV-1 (1). The retrovirus sequence is numbered with respect to the 5' edge of the 5' long terminal repeat (LTR) of the DNA provirus. pNLpuro is pNL4-3 in which *env* has been replaced with the selectable marker *SV40-puro* (32). pJUMP was constructed to serve as a template standard for PCR amplifications (see below) by cloning the 5' untranslated leader sequence of pNL4-3 downstream of the 3' LTR. pBluescript II KS- was digested to completion with *Xho*I and *Spe*I and ligated to two DNA fragments from pNL4-3: an *Xho*I-*Hind*III fragment (nucleotides 8887 to 9696) and a *Hind*III-*Spe*I fragment (nucleotides 531 to 1507). An infectious molecular clone of amphotropic MLV (ampho-MLV), strain 4070A (11), was provided by Sisir Chattopadhyay and Janet Hartley (National Institutes of Health, Bethesda, Md.). *penvAm* expresses the ampho-MLV₄₀₇₀ *env* gene from the Moloney MLV LTR (40).

The construction of mutant P222A has been described (18). Mutant G221A was constructed with a *Pst*I-*Spe*I fragment (nucleotides 1411 to 1509) from HIV-1_{HXB2} in pBluescript II KS- (Stratagene Cloning Systems, La Jolla, Calif.) as a template, the Transformer site-directed mutagenesis kit (Clontech, Palo Alto, Calif.), and the mutagenic oligonucleotide 5'-CCTGGTCAATAGGCGCCGATGCACTGGATG-3'. The sequence was confirmed by dideoxy sequencing with T7 and M13 reverse primers. Mutant sequences were transferred into pT7HG(pro-) for expression in bacteria or into pNL4-3 or pNLpuro for expression within the context of a provirus.

Cell culture and DNA transfection. Human 293T fibroblasts were maintained in Dulbecco modified Eagle's medium-F12 (1:1) supplemented with 10% fetal calf serum. The human lymphocyte line Jurkat (67) was obtained from the National Institutes of Health AIDS Research and Reference Program and maintained in RPMI 1640 supplemented with 10% fetal calf serum. Viral proteins were expressed transiently by calcium phosphate transfection of 10⁶ µg of supercoiled proviral DNA into 293T cells with a mammalian cell transfection kit (Specialty Media, Lavellette, N.J.). Cotransfections of pNLpuro and *penvAm* contained 10 µg of each plasmid. Viral infections were initiated with 10⁷ cells of the lymphocyte line indicated below and 2 µg of proviral DNA and 250 µg of DEAE-dextran (Pharmacia Biotech Inc., Piscataway, N.J.) per ml in 1 ml of serum-free RPMI 1640 for 20 min at room temperature.

Virion purification and Western (immunoblot) analysis. Supernatant (7.5 ml) was collected from 293T cells 48 h after transfection with infectious proviral constructs (approximately 10⁴ infectious units/ml), centrifuged at 13,000 × *g* for 5 min, and passed through a 0.45-µm-pore-size filter to remove cellular debris. The filtrate was layered on a step gradient consisting of 2 ml of 25% sucrose over 2 ml of 45% sucrose in TNE (10 mM Tris-HCl [pH 7.5], 100 mM NaCl, and 1 mM EDTA) and was centrifuged at 80,000 × *g* for 2 h in a Beckman SW41 rotor. The virion-containing interface was harvested and diluted to 6 ml with TNE, and the virions were pelleted at 80,000 × *g* for 2 h in an SW41 rotor. The pellet was resuspended in either 50 µl of 2× sodium dodecyl sulfate (SDS) sample buffer for Western blotting or processed for RNA analysis or endogenous-RT assays as described below.

For Western analysis, virion-associated proteins were size separated by SDS-polyacrylamide gel electrophoresis. The volume of sample loaded on the gel was normalized for intersample RT activity. Proteins were transferred to nitrocellulose membranes with a miniblotting apparatus (Bio-Rad, Hercules, Calif.). Binding of primary antibodies was detected by an alkaline phosphatase reaction by using the Vectastain Elite kit (Vector Laboratories, Burlingame, Calif.).

Antibodies and CsA. Murine monoclonal anti-HIV-1 p24 was obtained from Dupont NEN (NEA-9306). Rabbit anti-HIV-1 gp120 was obtained from Intracel

(Cambridge, Mass.). Mouse monoclonal anti-HIV-1 RT was a gift from Alise Reicin (Columbia University, New York, N.Y.). Rabbit anti-HIV-1 Vpr was a gift from Lee Ratner (Washington University, St. Louis, Mo.). Rabbit anti-CyPA antibody was a gift from Louis Henderson (National Cancer Institute, Frederick, Md.). CsA was obtained from Sandoz Pharmaceuticals Corporation (East Hanover, N.J.) and dissolved in ethanol to make a 1 mM stock solution prior to addition to tissue culture media.

Exogenous-RT assay. Either 10 µl of straight cell culture supernatant (viral replication assays) or 10 µl of precleared, filtered supernatant (transient transfections of proviral constructs) was added to 50 µl of RT cocktail {60 mM Tris-HCl (pH 8.0), 180 mM KCl, 6 mM MgCl₂, 6 mM dithiothreitol, 0.6 mM ethylene glycol-bis(β-aminoethyl ether)-*N*, *N*, *N*', *N*'-tetraacetic acid (EGTA), 0.12% Triton X-100, 6-µg/ml oligo(dT), 12-µg/ml poly(rA), 0.05 mM [α-³²P]dTTP (800 Ci/mmol)} for 1 h at 37°C. To detect MLV RT activity, MnCl₂ was substituted for MgCl₂. Two microliters was spotted onto DE-81 paper and washed three times with 2× SSC (1× SSC is 0.15 M NaCl plus 0.015 M sodium citrate). A PhosphorImager (Molecular Dynamics, Sunnyvale, Calif.) was used to quantitate the radioactivity incorporated.

Endogenous-RT assay. Virions were purified from 2 ml of 293T-cell transfection supernatant as described above, normalized for particle number by exogenous RT activity and p24 content, and resuspended in 500 µl of RPMI 1640. Fifteen microliters of each virion preparation was then mixed with 2× endogenous-reaction buffer (200 mM Tris-HCl [pH 8.1], 30 mM NaCl, 6 mM MgCl₂, 2 mM EGTA, 1 mM each deoxynucleoside triphosphate [dNTP], and 0.2% Nonidet P-40). Reaction mixtures were incubated at 39°C for 2 h, and then the reactions were stopped by the addition of 1 µl of 10% SDS. As negative controls, reactions were run without dNTPs. Samples were extracted with a 1:1 mixture of phenol and chloroform, ethanol precipitated, and resuspended in 30 µl of Tris-EDTA. Two microliters was used as a template for PCR with primers specific for minus-strand strong-stop DNA as described below.

Analysis of viral RNA. Virion preparations normalized for RT and purified from 7.5 ml of transfection supernatant as described above were suspended in 200 µl of RNazol B (Tel-Test, Inc., Friendswood, Tex.) and processed according to the manufacturer's instructions. tRNA was added as a carrier prior to ethanol precipitation. Total cellular RNA was prepared similarly from 10⁶ transfected cells. The complete viral RNA pellet or 15 µg of cellular RNA was subjected to Northern (RNA) analysis by standard methods (54). Blots were probed with a gel-purified 719-nucleotide *Xho*I-*Hind*III fragment from pNL4-3 (nucleotides 8887 to 9606) labeled with the Megaprime kit (Amersham, Arlington, Ill.). This probe encompasses sequences from the 3' end of the provirus and recognizes unspliced and all spliced forms equally well. The intensity of individual bands was quantitated with a PhosphorImager (Molecular Dynamics).

PCR analysis of reverse transcripts in acutely infected cells. Viral stocks from transfected 293T cells were filtered, aliquoted, and stored at -70°C. Stocks produced by wild-type pNL4-3 had an approximate titer of 10⁶ infectious units/ml, and volumes were adjusted to normalize for variation in RT between transfections. To degrade plasmid DNA remaining from the transfection of proviral DNA plasmids, viral stocks were treated with 75 U of DNase I (Worthington Biochemical Corporation, Freehold, N.J.) per ml in the presence of 10 mM MgCl₂ for 1 h at 37°C, prior to infection. As negative controls for each transfection, virion aliquots were heat inactivated for 15 min at 80°C.

For each infection, 10⁶ Jurkat cells were incubated in 200 µl of a DNase-treated virion preparation for 1 h at 37°C. One microliter of RPMI 1640 with serum was added, and the infection was allowed to proceed for the time periods indicated below. Low-molecular-weight DNA was prepared from infected cells by standard procedures (24) and resuspended in 30 µl of Tris-EDTA with RNase A at 10 µg/ml. Two microliters of each preparation was used as a template in PCR. All reactions were carried out with a GeneAmp 2400 PCR system (Perkin-Elmer, Foster City, Calif.) in a total volume of 20 µl in a solution containing 0.5 U of AmpliTaq DNA polymerase, 0.2 mM each of the four dNTPs, 5 pmol of each primer, 50 mM KCl, 10 mM Tris-HCl (pH 8.3), 1.5 mM MgCl₂, and 0.001% (wt/vol) gelatin. The standard program for amplification of viral sequences was 26 cycles of 94°C for 30 s, 65°C for 30 s, and 72°C for 30 s. Under these conditions a linear increase in signal with increasing amounts of DNA template was observed for amplification up to 30 cycles.

All samples were first screened for contaminating pNL4-3 DNA carried over from transfection by amplification with a forward primer corresponding to 5' cellular flanking DNA from pNL4-3 (5'-CTCAGTTGGATCTCCACAGGTC-3'; nucleotides 14642 to 14663) and a reverse primer corresponding to the U3 region from the 5' LTR (5'-GCACCATCAAAGGTGAGTGG-3'; nucleotides 117 to 137). Any samples containing contaminating plasmid DNA detectable by PCR amplification were discarded.

To normalize the quantity of total cellular DNA present in each sample, human mitochondrial DNA (2) was amplified for 15 cycles under the conditions described above with a forward primer corresponding to nucleotides 247 to 271 (5'-GAATGTCTGCACAGCCACTTCCAC-3') and a reverse primer corresponding to nucleotides 719 to 743 (5'-GATCGTGGTGTATTAGAGGGTG AAC-3'). Measured cell equivalents of low-molecular-weight DNA were serially diluted and amplified in parallel to demonstrate a linear increase in signal with increasing amounts of template within a given experiment.

Full-length linear DNA was amplified with a pair of primers which distinguish between plasmid DNA and viral DNA synthesized de novo. This was possible

because of mismatches between the 5' and 3' LTRs of pNL4-3 and the template switches characteristic of reverse transcription (see Fig. 4). The plus-strand primer, J1, corresponded to U3 sequences of the 3' LTR (5'-ACAAGCTAG TACCAGTTGAGCCAGATAAG-3'; nucleotides 9211 to 9240). The minus-strand primer, J2, corresponded to sequences 3' of the primer-binding site (5'-GCCGTGCGCGCTTCAGCAAGC-3'; nucleotides 701 to 721). Known quantities of pJUMP DNA were diluted and amplified in parallel to demonstrate a linear increase in signal with increasing amounts of template.

Minus-strand strong-stop DNA was detected with a primer corresponding to R region sequences from the 5' LTR (5'-GGCTAACTAGGGAACCCACTG-3'; plus-strand nucleotides 496 to 516) and a primer corresponding to 5' LTR U5 sequences (5'-CTGCTAGAGATTTTCCACACTGAC-3'; minus-strand nucleotides 612 to 635). pNL4-3 DNA was serially diluted and amplified in parallel to demonstrate a linear increase in signal with increasing amounts of template within a given experiment.

Following infection with MLV_{4070A}, full-length linear viral DNA was amplified with the following primers: 5'-CCAGTCTCCGATAGACTGAGTCG-3' (sense) and 5'-CGTCAGTTCCACCACGGGTCC-3' (antisense). Cloned MLV_{4070A} DNA was used as a template control.

PCR products were resolved on 1.2% agarose gels, transferred to nylon membranes, hybridized to radiolabeled probes, and visualized by autoradiography by standard methods (54). To detect HIV-1 sequences, probes were generated by PCR amplification of pNL4-3 fragments with the primer pairs described above and radioactively labeling with the Amersham Megaprime kit. To detect mitochondrial sequences, a probe consisting of mitochondrial sequences 247 to 743 was labeled similarly. The signal intensities of probes that hybridized to the viral sequences were quantitated on a PhosphorImager (Molecular Dynamics) and normalized on the basis of the signal intensity of the probe that hybridized to the mitochondrial sequences.

RESULTS

Genetic or pharmacologic disruption of Gag binding to CyPA inhibits HIV-1 replication. To determine the role of CyPA in the HIV-1 life cycle, the interaction between CyPA and Gag was disrupted by genetic and pharmacologic means. As previously demonstrated by affinity chromatography with GST-CyPA bound to glutathione-agarose beads (35), recombinant, wild-type HIV-1 Gag polyprotein is quantitatively recovered and detected by Western blotting; this is not the case with Gag mutant P222A, indicating that the mutant's affinity for CyPA is significantly decreased (Fig. 1A). Mutant G221A was even more disruptive of binding to CyPA than P222A (Fig. 1A), as indicated by the fact that trace binding to CyPA was seen with P222A under conditions in which G221A binding was not detectable. That G221A and P222A were still capable of binding to CyPB suggested that the overall structure of these mutant proteins was not grossly disrupted (Fig. 1A).

HIV-1 provirus expressing mutant P222A is unable to replicate in tissue culture (18). Similarly, mutant G221A renders an otherwise-infectious provirus noninfectious (Fig. 1B). There was no evidence of viral replication with either mutant virus for up to 60 days in tissue culture. Thus, HIV-1 Gag mutants G221A and P222A disrupt binding to CyPA in vitro and HIV-1 replication in tissue culture and provide genetic tools for studying the function of CyPA in HIV-1 replication.

To pharmacologically disrupt CyPA function, we used CsA, which blocks Gag binding to CyPA in vitro (35), prevents incorporation of CyPA into HIV-1 virions (18, 63), and specifically inhibits the replication of only those retroviruses which package CyPA (7a, 26, 51, 63, 65).

CyPA is not required for HIV-1 virion assembly. The effect of disruption of CyPA incorporation on HIV-1 virion assembly was first examined. Since CsA and the two Gag mutants disrupt viral replication, HIV-1 virions were expressed transiently by transfection of proviral DNAs. Neither virions produced in the presence of CsA nor virions produced by either of the mutant proviruses were diminished in particle-associated p24 (Fig. 2A). Also, virion density, as assessed on linear sucrose gradients, was unaffected, and virion morphology, as assessed by electron microscopy, was indistinguishable from that of the

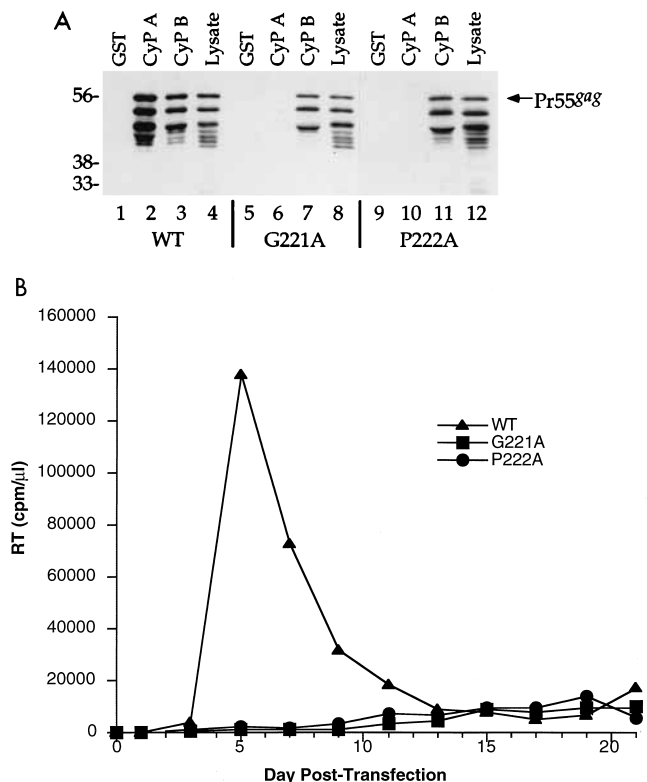

FIG. 1. Disruption of HIV-1 Gag polyprotein binding to CyPA by *gag* missense mutations and concomitant viral replication defect. (A) Western blot probed with anti-CA antibody demonstrating binding of recombinant HIV-1 Gag polyprotein (Pr55^{gag}) to GST, GST-CyPA, or GST-CyPB, as indicated. Binding of wild-type Gag, Gag mutant G221A, and Gag mutant P222A is shown in lanes 1 to 4, 5 to 8, and 9 to 12, respectively. Total bacterial lysate containing each Gag protein is shown in lanes 4, 8, and 12, respectively. The position of migration of full-length Gag polyprotein (Pr55^{gag}) is indicated on the right. The positions of migration of molecular size markers (in kilodaltons) are indicated on the left. (B) Replication of wild-type HIV-1_{NL4-3} and mutants G221A and P222A following transfection of proviral DNAs into the Jurkat T-cell line. RT activity accumulating in the cell supernatant is shown for the indicated day posttransfection. WT, wild type.

wild type (data not shown). Thus, the Gag-CyPA interaction is not required for gross virion yield or integrity.

Purified wild-type virions contain one CyPA molecule for every 5 to 10 Gag molecules (18). Virions produced by mutants G221A and P222A had significantly reduced quantities of CyPA incorporated (Fig. 2A). A comparison of mutant-virion-associated CyPA in parallel with serial dilutions of wild-type virion protein demonstrated that P222A incorporates 5-fold less CyPA than the wild type (Fig. 2B); the effect of G221A was more drastic, with a reduction of at least 10-fold (Fig. 2B). The quantitative reduction of CyPA incorporation into virions by the two mutants correlates with the results of in vitro binding assays with recombinant protein, supporting the contention that affinity for the Gag polyprotein is the major determinant for CyPA incorporation into virions.

CyPA incorporation into virions is inhibited in a linear fashion by the presence of CsA during virion production (18, 63). Virions produced in the presence of 10 μM CsA have a 5- to 10-fold decrease in CyPA incorporation with no effect on virion production (Fig. 2B, lane 7). These data demonstrate that CyPA incorporation into virions is significantly disrupted by CsA and by mutants G221A and P222A with no concomitant effects on virion yield, density, or morphology.

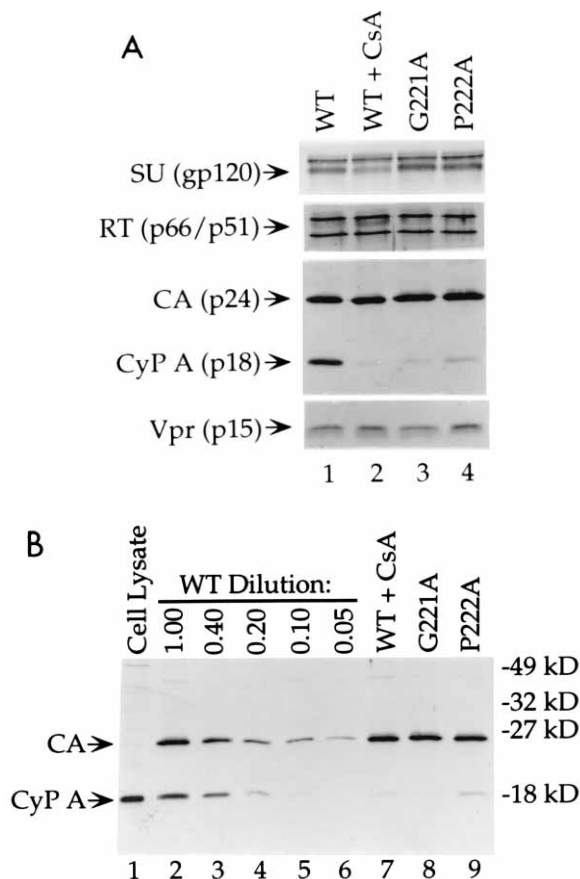

FIG. 2. CyPA is not required for the production of HIV-1 virions possessing a full complement of virion proteins. (A) Virions were purified from the supernatant of 293T cells transfected with the following proviral DNAs: wild-type HIV-1, wild-type HIV-1 in the presence of 10 μ M CsA, mutant G221A, and mutant P222A. Samples were normalized for RT activity prior to gel loading, and virion-associated proteins were probed by Western blotting with antibodies against CyPA and the indicated viral proteins. SU, Env surface component. (B) Western blot, as in panel A, probed simultaneously with antibodies to CA and CyPA. The wild-type virion preparation was serially diluted as indicated (lanes 2 to 6), prior to gel loading. CyPA from the total lysate of 293T cells is shown (lane 1). The positions of migration of protein markers are indicated on the right. WT, wild type.

CyPA is not required for packaging of viral proteins or viral genomic RNA. CyPA-deficient virions were subjected to Western blot analysis with antibodies against each of the major virus-encoded virion-associated proteins. Compared with wild-type virions, neither CsA nor mutant G221A or P222A had observable effects on the virion incorporation of *env*-encoded gp120 or of the two forms of *pol*-encoded RT (Fig. 2A). Viral protease activity was not noticeably reduced, as evidenced by complete processing of the Gag and Gag-Pol polyproteins to the mature cleavage products p24, p51, and p66 (Fig. 2A). The ratio of virion-associated RT activity to CA was also unaffected by the drug or by either of the mutants (data not shown). Finally, Vpr, a protein which is incorporated into virions by the Gag polyprotein (30, 34, 45), was also incorporated in normal quantities (Fig. 2A). Thus, CyPA is required neither for the virion incorporation of any of the major HIV-1-encoded proteins nor for readily measurable enzymatic activities.

Retroviral RNA is also packaged into virions via interaction with the Gag polyprotein (33), and so the importance of CyPA incorporation into virions for RNA packaging was examined by

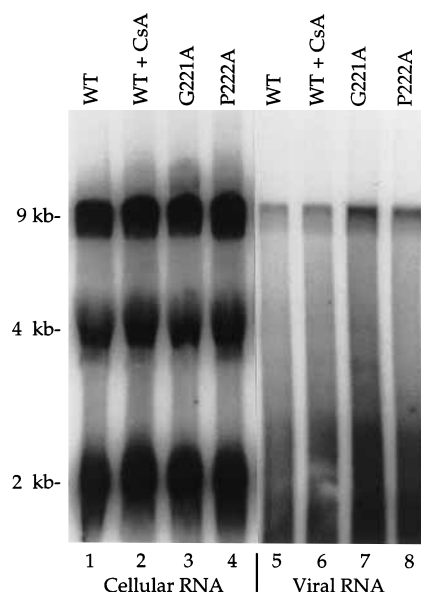

FIG. 3. CyPA is not required for packaging of HIV-1 genomic RNA. Shown is a Northern blot probed for HIV-1 sequences. Total cellular RNA (lanes 1 to 4) and virion-associated RNA (lanes 5 to 8) were harvested following transfection of 293T cells with wild-type HIV-1_{NL4.3} proviral DNA (WT), wild-type DNA in the presence of 10 μ M CsA, mutant G221A, or mutant P222A. The positions of migration of the three major viral RNA forms are indicated.

Northern (RNA) analysis. Viral RNAs of 9, 4, and 2 kb were found to be expressed in cells transfected with wild-type HIV-1 proviral DNA, in the presence or absence of 10 μ M CsA, and in cells transfected with mutant G221A or P222A (Fig. 3). The ratios of the different forms, as well as the absolute abundance of the RNAs, were comparable in all cases. Virions produced in the presence of CsA or by either of the mutant proviral DNAs selectively incorporated the unspliced, viral genomic RNA in quantities identical to that of the wild type (Fig. 3). The same results were obtained when virion-associated RNA was assessed by a more quantitative RNase protection assay (data not shown). Thus, CyPA incorporation is not required for viral RNA packaging.

CyPA is required for HIV-1 DNA synthesis in acutely infected T cells. Since disruption of CyPA incorporation into virions by CsA or by the Gag mutants had no observable effect on virion biochemical properties, the infectivity of CyPA-deficient virions was evaluated next. Viral stocks were normalized by using particle-associated RT and p24 and used to infect Jurkat T cells. Low-molecular-weight DNA was harvested from the acutely infected cells and used as a template in PCRs designed to amplify the products of reverse transcription. All amplifications were performed within a range of cycles that had been demonstrated to provide a linear relationship between the amount of the template and the quantity of the amplified product. For each set of reactions, template standards were used to demonstrate a linear increase in signal within the range of template concentrations being tested. Mitochondrial DNA was amplified to normalize the amount of infected cell lysate used as a template from each sample.

Viral stocks were produced by transient transfection of proviral DNAs. Several precautions were taken to ensure that the template amplified in the PCR had been synthesized during the infection and was not contaminating DNA from the transfection. First, virion stocks were treated with DNase I prior to infection. Second, samples were discarded if contaminating

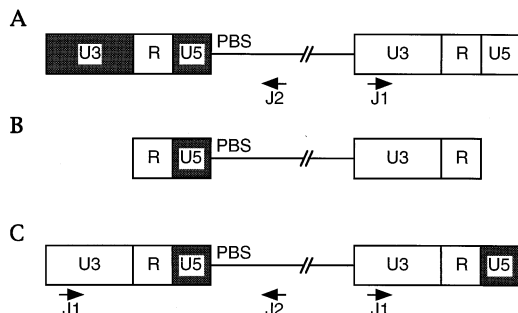

FIG. 4. HIV-1-specific PCR primer pair used to distinguish viral DNA synthesized de novo from transfected plasmid DNA. (A) pNL4-3 contains a hybrid provirus with sequence mismatches between the 5' LTR (black boxes) and the 3' LTR (white boxes). (B) Viral genomic RNA resulting from pNL4-3-directed transcription contains one U3 region derived from the 3' LTR. (C) De novo viral DNA synthesis after T-cell infection requires template switching by RT in which the 5' LTR is generated with sequences from the 3' LTR of pNL4-3. PCR primers J1 and J2 produce a discrete product with a de novo-synthesized viral DNA template but not with pNL4-3 DNA. U5 and U3, sequences unique to the 5' and 3' ends of the viral genomic RNA, respectively. R, sequences common to both ends of the genomic RNA. PBS, tRNA primer binding site. The arrows indicate the position and orientation of the sequences of the indicated primers. For primer sequences, see Materials and Methods. The figure is not drawn to scale.

plasmid DNA was detected by PCR with primers specific for sequences in the plasmid which flank the provirus. Lastly, in the case of full-length proviral DNA, primers that distinguish between plasmid DNA and viral DNA synthesized de novo were designed. This was possible because of fortuitous nucleotide mismatches between the two LTRs of pNL4-3 and the fact that RT reconstructs the 5' LTR of the viral DNA by using U3 sequences from the 3' end of viral genomic RNA (for an explanation, see Fig. 4).

Full-length linear reverse transcripts were detectable in cells

infected with wild-type viral stocks by 2 h postinfection and accumulated until 8 h postinfection (Fig. 5). This time course for the production of HIV-1 DNA is similar to that previously reported (28). Quantitative standards indicated that roughly 400 full-length linear products were detected at the 8-h point. Compared with wild-type viral infection, significant reductions in the synthesis of viral DNA were observed following infection with viral mutants G221A and P222A (Fig. 5). At the 8-h point, 30- and 7-fold reductions in the amount of product were observed following infection with G221A and P222A, respectively. The quantitative reduction in DNA synthesis correlates with the effects of the mutants on CyPA binding in vitro and with CyPA incorporation into virions (Fig. 2B), suggesting that the reduction in viral DNA synthesis is functionally related to the failure of mutant Gag proteins to allow incorporation of CyPA into the virions.

To obtain further evidence that CyPA incorporation into virions is required for viral DNA synthesis, viral stocks were produced by wild-type provirus in the presence of CsA at concentrations which inhibit viral replication but which have no effect on host cell replication. Virions produced in the presence of 0.5 μ M CsA incorporate approximately one-half the amount of CyPA as virions produced in the absence of the drug (Fig. 6A); virions produced in the presence of 2.5 μ M CsA contain about one-fourth the amount of CyPA (Fig. 6A). Virions were purified from drug-containing medium and used to infect Jurkat cells in drug-free medium. PCR amplification of low-molecular-weight DNA following infection demonstrated that DNA synthesis was significantly less efficient after infection with virions produced in the presence of CsA (Fig. 6B). At 8 h postinfection, virions produced in the presence of 0.5 μ M CsA had synthesized one-half the amount of DNA that the wild type had; 2.5 μ M CsA had a greater effect, reducing DNA synthesis fourfold. No additional reduction in infectivity was observed if virions produced in the presence of 2.5 μ M

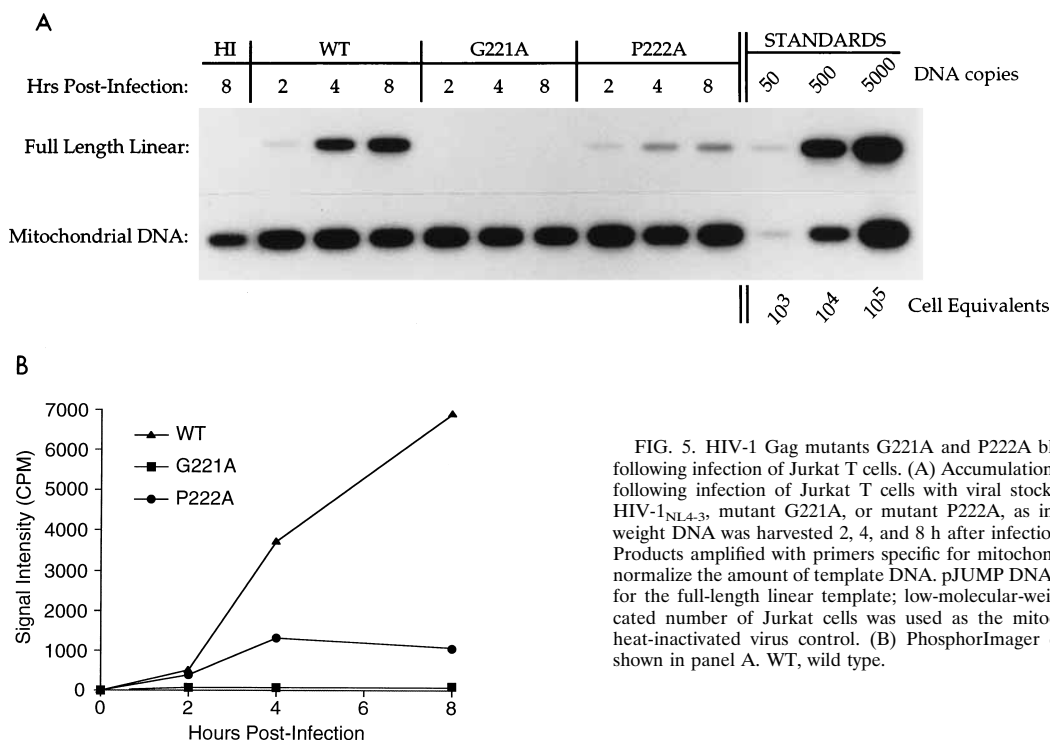

FIG. 5. HIV-1 Gag mutants G221A and P222A block viral DNA synthesis following infection of Jurkat T cells. (A) Accumulation of full-length viral DNA following infection of Jurkat T cells with viral stocks produced by wild-type HIV-1_{NL4-3}, mutant G221A, or mutant P222A, as indicated. Low-molecular-weight DNA was harvested 2, 4, and 8 h after infection and amplified by PCR. Products amplified with primers specific for mitochondrial DNA were used to normalize the amount of template DNA. pJUMP DNA was used as the standard for the full-length linear template; low-molecular-weight DNA from the indicated number of Jurkat cells was used as the mitochondrial standards. HI, heat-inactivated virus control. (B) PhosphorImager quantitation of products shown in panel A. WT, wild type.

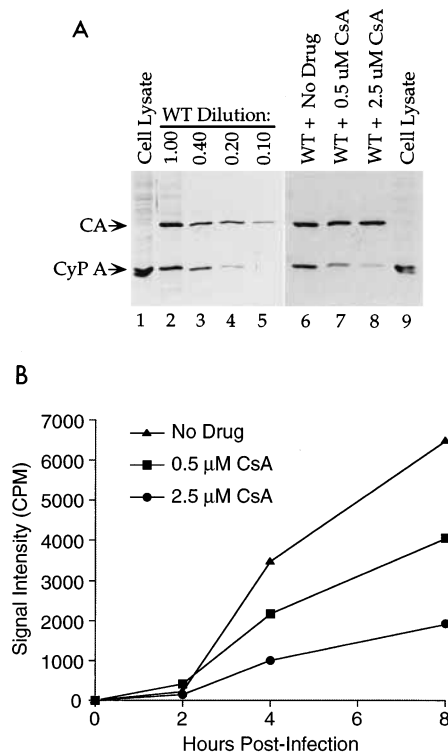

FIG. 6. Disruption of CyPA incorporation into HIV-1 virions by CsA correlates with inhibition of HIV-1 DNA synthesis. (A) Western blot demonstrating the effect of CsA on CyPA incorporation into HIV-1 virions. 293T cells were transfected with HIV-1_{NL4.3} proviral DNA in the presence of 0, 0.5, or 2.5 μM CsA. Virions were purified from the supernatant, and associated proteins were probed simultaneously with antibodies recognizing HIV-1 CA and CyPA. The wild-type virion preparation was serially diluted as indicated, prior to gel loading. CyPA from the total lysate of 293T cells is shown. The positions of migration of CA and CyPA are indicated on the left. (B) Production of full-length linear viral DNA following infection with virions produced in the presence of CsA. Jurkat cells were infected with viral stocks produced in the presence of 0, 0.5, or 2.5 μM CsA, as indicated. Virions were pelleted from drug-containing medium and used to infect cells in the absence of the drug. PCR was performed and products were quantitated as described in the legend for Fig. 5. WT, wild type.

CsA were used to infect cells in the presence of CsA (data not shown). Similarly, overnight incubation of target cells in CsA prior to infection with wild-type virus had no effect on viral DNA synthesis (data not shown), indicating that CyPA must be present in the virion prior to infection and cannot be provided by the infected target cell. We conclude that disruption of CyPA incorporation into virions by either genetic or pharmacologic means prevents the synthesis of viral DNA following infection of a new target cell.

To determine if there is a block to the initiation of reverse transcription following infection with CyPA-deficient virions, viral DNA was amplified with primers specific for the earliest product of reverse transcription, minus-strand strong-stop DNA. Following infection with wild-type virus, significant quantities of viral DNA were detected by 2 h, with the peak in synthesis occurring earlier than for the full-length linear product (Fig. 7A). In contrast, there was a block to synthesis following infection with mutant virus G221A or P222A (Fig. 7A). Thus, CyPA incorporation into virions is required for synthesis of even the earliest RT products.

To address whether the block to viral DNA synthesis following infection reflects an intrinsic defect in reverse transcription, CyPA-deficient virions were tested for the ability to carry

out the so-called endogenous-RT reaction. Standard in vitro assays for virion-associated RT measure DNA polymerase activity on an exogenous homopolymeric template-primer (22). In contrast, the endogenous-RT assay not only examines polymerase activity but also examines the integrity of the viral genomic RNA template and the associated tRNA primer; it can also be used to monitor other details of the reaction. Virions produced by mutants G221A and P222A were found to synthesize viral DNA under endogenous conditions as efficiently as wild-type virions (Fig. 7B). The DNA detected in these reactions had been synthesized de novo and was not contaminating DNA from the transfection or from synthesis prior to the incubation, since no viral DNA was detected when virions were incubated without dNTPs (Fig. 7B). In addition, 2.5 μM CsA had no effect on the ability of wild-type or mutant virions to carry out the endogenous reaction (Fig. 7B). These experiments demonstrate that CyPA-deficient virions have no intrinsic defect in reverse transcription and indicate that CyPA is required for a very early event in the infectious cycle, prior to the initiation of reverse transcription.

CyPA is required for an event in the HIV-1 life cycle following receptor binding and membrane fusion. CyPA-deficient virions might fail to initiate viral DNA synthesis after infection of Jurkat cells because of a block in receptor binding, membrane fusion, or virion uncoating. The latter explanation seems most likely since CA, the virion-associated Gag protein which retains CyPA-binding ability, is located in the virion core (20), where it is unlikely to have an effect on gp120-CD4 interactions or on membrane fusion. The observation that CD4⁺ T cells form syncytia following transfection of G221A or P222A proviral DNAs (data not shown) supports this contention. Similarly, there is no reduction in syncytium formation when cells chronically infected with HIV-1 are mixed with fresh CD4⁺ cells in the presence of CsA (59). Lastly, the replication of primate immunodeficiency viruses other than HIV-1 is not inhibited by CsA, despite the fact that these viruses utilize the same cell surface receptor as HIV-1 (6, 7a, 18, 63).

To determine if CsA or the Gag mutants have effects on receptor binding or membrane fusion, CyPA-deficient virions were pseudotyped with Env from amphi-MLV. The replication of amphi-MLV in Jurkat cells is not altered by doses of CsA which completely inhibit HIV-1 replication (7a); correspondingly, the kinetics of amphi-MLV viral DNA synthesis in acutely infected T cells is not altered by CsA (Fig. 8A). Viral stocks were produced by cotransfecting pNLpuro with *pen-vAm*; pNLpuro (32) contains a complete HIV-1 provirus with *env* sequences deleted, and *pen-vAm* expresses amphi-MLV Env. We and others have shown that virions produced by pNLpuro, or analogous constructs (43), are not infectious and that the block to infection occurs prior to viral DNA synthesis (data not shown). Pseudotyping these virions with amphi-MLV Env renders them infectious (43), as indicated by the synthesis of viral DNA by 8 h after infection of Jurkat cells (Fig. 8B). In contrast, pNLpuro virions either produced in the presence of CsA or which contain *gag* mutations which disrupt CyPA binding are not rescued by pseudotyping with amphi-MLV Env (Fig. 8B). Thus, CyPA is required for a step in the HIV-1 life cycle prior to reverse transcription but subsequent to receptor binding and membrane fusion.

DISCUSSION

The experiments presented here demonstrate that the role of CyPA in HIV-1 replication is extraordinary in several respects. CyPA is the first cellular protein demonstrated to be incorporated into a retrovirus and shown to promote virion

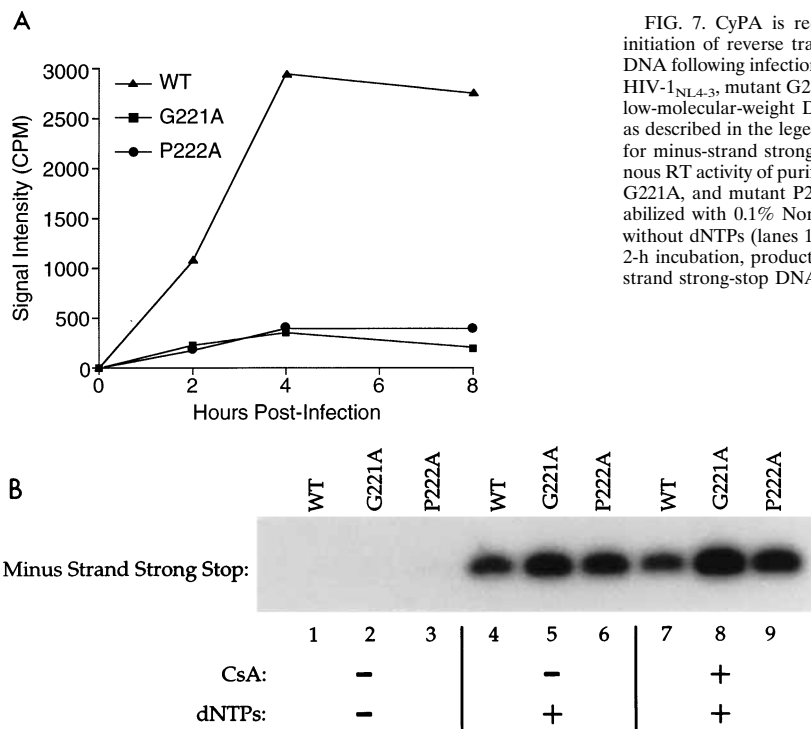

FIG. 7. CyPA is required for a step in the infectious cycle prior to the initiation of reverse transcription. (A) Production of minus-strand strong-stop DNA following infection of Jurkat T cells with viral stocks produced by wild-type HIV-1_{NL4-3}, mutant G221A, or mutant P222A, as indicated. Infection, harvest of low-molecular-weight DNA, and PCR product quantifications were performed as described in the legend for Fig. 5, except for the use of PCR primers specific for minus-strand strong-stop DNA (see Materials and Methods). (B) Endogenous RT activity of purified virions produced by transfection of wild-type, mutant G221A, and mutant P222A proviral DNAs, as indicated. Virions were permeabilized with 0.1% Nonidet P-40 and incubated with dNTPs (lanes 4 to 9) or without dNTPs (lanes 1 to 3). Lanes 7 to 9 contained 2.5 μ M CsA. Following a 2-h incubation, products were PCR amplified to detect the synthesis of minus-strand strong-stop DNA as in panel A. WT, wild type.

infectivity. There is a linear relationship between the disruption of CyPA incorporation into HIV-1 virions and the failure to synthesize viral DNA in acutely infected cells. Though CyPA might be necessary only within virus-producing cells, the fact that CyPA-deficient virions possess no biochemically detectable assembly defects suggests that CyPA functions within the virion after assembly and that CyPA can be added to the list of essential components incorporated into HIV-1 virions by the Gag polyprotein.

CyPA is also distinguished by its being the first cellular protein other than the cell surface receptor which has been shown to be required for the infection of a new target cell by a retrovirus. RT might be the direct target of CyPA *in vivo*, but this seems unlikely since detergent-permeabilized CyPA-deficient virions are enzymatically competent under endogenous conditions. For a number of reasons it is unlikely that CyPA-deficient virions are defective in virion receptor binding and membrane fusion properties. First, despite rigorous purification by multiple centrifugation steps, CyPA-deficient virions possess normal quantities of gp120, the virion protein which binds to the cell surface receptor and mediates membrane fusion. Second, there is no precedent for alteration of Env function by CA, the Gag polyprotein cleavage product in the mature virion core which retains CyPA binding (35). Third, neither CsA nor the Gag mutants block syncytium formation, indicating that CD4 binding and membrane fusion are maintained. Fourth, primate immunodeficiency viruses other than HIV-1 do not require CyPA and thus are not inhibited by CsA; these viruses utilize the same cell surface receptor as HIV-1, indicating that internalization following CD4 binding does not require CyPA. Lastly, despite the ability of amphi-MLV to replicate independently of CyPA, pseudotyping of CyPA-deficient HIV-1 virions with amphi-MLV Env does not restore infectivity. These data suggest that CyPA is required for a step between membrane fusion and reverse transcription, perhaps virion uncoating.

CsA and the mutants characterized here may provide valuable reagents for future studies of early events, such as virion uncoating. This step in the retroviral life cycle is notoriously difficult to study because of, among other things, the low fraction of infectious particles per total number of particles in virion stocks, variously estimated at 10^{-3} to 10^{-7} (13, 31, 46). In current models of the HIV-1 life cycle, CA forms the outer structure of the virion core (20). Following direct fusion of the virion and target cell membranes (5, 38, 58), the core of the virion is released into the cell cytoplasm, where reverse transcription takes place. The viral nucleoprotein complex is then transported to the nucleus, leaving CA in the cytoplasm (10, 15). We propose a model in which virion-associated CyPA alters the conformation of CA during these early events; perhaps by disengaging CA from the nucleoprotein complex, CyPA regulates the initiation of reverse transcription. Our data indicate that in order to have access to CA, CyPA must be incorporated into the virion during assembly and cannot be provided by the infected target cell.

CyPs are thought to regulate protein folding (21, 57, 62). They catalyze the isomerization of peptidyl-prolyl bonds, a process which is rate limiting for the folding of specific proteins *in vitro* (16) and *in vivo* (41). The observation that mutation of HIV-1 Gag polyprotein residue G-221 or P-222 disrupts binding to CyPA suggests that catalysis of the isomerization of the peptide bond between 221 and 222 may be critical for viral replication. For example, by altering the orientation of this bond, CyPA might induce the dissociation of CA from the preintegration complex.

Independent of its purported action as a foldase, CyP has been shown to function as a chaperone. In *Drosophila melanogaster*, the CyP homolog NinaA forms a specific and stable complex with the Rh1 isoform of rhodopsin; this complex is essential for transit of the visual pigment through the endoplasmic reticulum (3). As part of a stable complex with CA, CyPA might function as a chaperone that promotes the disas-

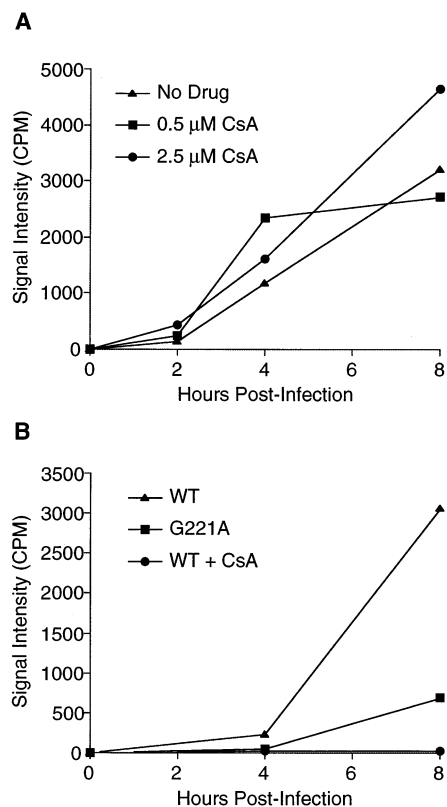

FIG. 8. CyPA is not required for CD4 binding or cell membrane fusion. (A) Effect of CsA on amphi-MLV viral DNA synthesis in acutely infected cells. Viral stocks were produced by transfection of 293T cells with MLV_{4070A} in the presence of the indicated concentrations of CsA. Jurkat cells preincubated in the same concentrations of CsA were then infected with the viral stocks. Low-molecular-weight DNA was harvested at the indicated times postinfection and amplified by PCR with primers specific for the full-length linear product. Otherwise, products were detected and quantitated as described in the legend for Fig. 5. (B) Viral DNA synthesis after infection with CyPA-deficient HIV-1 virions pseudotyped with amphi-MLV Env. Viral stocks were produced by cotransfection of 293T cells with pamEnv and either pNLpuro (WT), pNLpuro in the presence of 5 μ M CsA (WT + CsA), or pNLpuro containing the G221A mutation (G221A). Viral stocks were then normalized and used to infect Jurkat cells. Full-length linear DNA was detected and quantitated as described in the legend for Fig. 5.

sembly of the virion core after fusion of HIV-1 with the target cell membrane. Catalysis of virion disassembly would be analogous to the uncoating of clathrin cages by Hsp70 prior to vesicle fusion with membrane targets (52).

Filamentous-phage assembly is facilitated by the bacterial protein thioredoxin in a process that does not require the enzymatic activity of this chaperone; thioredoxin active-site cysteine mutants defective for redox activity are competent to promote assembly (53). However, it may not be so easy to determine if the prolyl isomerase activity of CyPA is required for its chaperone function in HIV-1 replication. Saturation mutagenesis of NinaA, for example, has not yielded a mutant which discriminates this protein's isomerase activity from its chaperone function (42). Similarly, we have found that all CyPA mutations which disrupt isomerase activity also disrupt Gag binding (7b). Some have suggested that isomerization by CyP is not in itself functionally relevant but is merely a necessary consequence of binding to X-Pro residues in the protein that is the substrate of the chaperone (55).

Though Gag incorporates CyPA into virions, and we believe that CA is the most likely substrate for virion-associated CyPA,

it is possible that one of the other viral proteins is the relevant CyPA substrate. In addition to being the only primate lentivirus to require CyPA for replication, HIV-1 is also distinguished by being the only retrovirus to encode Vpu. Despite this coincidence it is unlikely that CyPA is required for some aspect of Vpu function: Vpu is not part of the virion, and Vpu has not been shown to be necessary for early events in the virus life cycle. Disruption of HIV-1 *vif* or *nef* leads to a phenotype similar to that of CyPA-deficient virions (for a review, see reference 64). Nevertheless, the function of these genes is not likely to be dependent upon CyPA. CsA blocks replication of *nef* mutant virus (6), and it blocks HIV-1 replication in cell types which are *vif* permissive or restrictive. Thus, it is most likely that CA is the relevant substrate for HIV-1 virion-associated CyPA.

HIV-1 is the only retrovirus shown to require CyPA for replication, but it is not obvious why HIV-1 should be uniquely dependent upon a cellular chaperone. It is possible that the CA of other primate lentiviruses requires an interaction with a chaperone other than CyPA. Such a chaperone might be a known heat shock protein or perhaps an unidentified immunophilin. FKBP12, the cytoplasmic peptidyl-prolyl isomerase target of the immunosuppressive drug FK506, is not a likely candidate since we detect no interaction between it and the Gag polyproteins of primate lentiviruses (17).

ACKNOWLEDGMENTS

We thank Andrew Kaplan for technical advice; Skip Melsen and Richard Compans for electron microscopy; and Arthur Bank, Frederick R. Bloom, Sisir Chattopadhyay, Janet Hartley, Louis Henderson, Lee Ratner, Alise Reicin, and David Weiner for reagents. Jurkat clone E6-1 from the American Type Culture Collection was obtained through the AIDS Research and Reference Reagent Program, Division of AIDS, NIAID.

This work was supported by grant AI36199 from the National Institute of Allergy and Infectious Diseases to J.L. J.L. is an Irma T. Hirsch Scholar.

REFERENCES

- Adachi, A., H. E. Gendelman, S. Koenig, T. Folks, R. Willey, A. Rabson, and M. A. Martin. 1986. Production of acquired immunodeficiency syndrome-associated retrovirus in human and nonhuman cells transfected with an infectious molecular clone. *J. Virol.* **59**:284-291.
- Anderson, S., A. T. Bankier, B. G. Barrell, M. H. L. deBruijn, A. R. Coulson, H. Drouin, I. C. Eperon, D. P. Nierlich, B. A. Roe, S. Sanger, P. H. Schreier, A. J. H. Smith, R. Staden, and I. G. Young. 1981. Sequence and organization of the human mitochondrial genome. *Nature (London)* **290**:457-465.
- Baker, E. K., N. J. Colley, and C. S. Zuker. 1994. The cyclophilin homolog NinaA functions as a chaperone, forming a stable complex in vivo with its protein target rhodopsin. *EMBO J.* **13**:4886-4895.
- Bartz, S. R., E. Hohenwarter, M.-K. Hu, D. H. Rich, and M. Malkovskiy. 1995. Inhibition of human immunodeficiency virus replication by nonimmunosuppressive analogs of cyclosporin A. *Proc. Natl. Acad. Sci. USA* **92**:5381-5385.
- Bediniger, P., A. Moriarty, R. C. von Borstle, N. J. Donovan, K. S. Steimer, and D. R. Littman. 1988. Internalization of the human immunodeficiency virus does not require the cytoplasmic domain of CD4. *Nature (London)* **334**:162-165.
- Billich, A., F. Hammerschmid, P. Peichl, R. Wenger, G. Zenke, V. Quesniaux, and B. Rosenwirth. 1995. Mode of action of SDZ NIM 811, a nonimmunosuppressive cyclosporin A analog with activity against human immunodeficiency virus (HIV) type 1: interference with HIV protein-cyclophilin A interactions. *J. Virol.* **69**:2451-2461.
- Bowerman, B., P. O. Brown, J. M. Bishop, and H. E. Varmus. 1989. A nucleoprotein complex mediates the integration of retroviral DNA. *Genes Dev.* **3**:469-478.
- Braaten, D., E. K. Franke, and J. Luban. Cyclophilin A is required for the replication of group M HIV-1 and SIV_{CPZ}GAB but not group O HIV-1 or other primate immunodeficiency viruses. Submitted for publication.
- Braaten, D., and J. Luban. Unpublished data.
- Bryant, M., and L. Ratner. 1990. Myristoylation-dependent replication and assembly of human immunodeficiency virus 1. *Proc. Natl. Acad. Sci. USA* **87**:523-527.

9. Bukrinsky, M. I., S. Haggerty, M. P. Dempsey, N. Sharova, A. Adzhubel, L. Spitz, P. Lewis, D. Goldfarb, M. Emerman, and M. Stevenson. 1993. A nuclear localization signal within HIV-1 matrix protein that governs infection of non-dividing cells. *Nature (London)* **365**:666-669.
10. Bukrinsky, M. I., N. Sharova, T. L. McDonald, T. Pushkarskaya, W. G. Tarpley, and M. Stevenson. 1993. Association of integrase, matrix, and reverse transcriptase antigens of human immunodeficiency virus type 1 with viral nucleic acids following acute infection. *Proc. Natl. Acad. Sci. USA* **90**:6125-6129.
11. Chattopadhyay, S. K., A. I. Oliff, D. L. Linemeyer, M. R. Lander, and D. R. Lowy. 1981. Genomes of murine leukemia viruses isolated from wild mice. *J. Virol.* **39**:777-791.
12. Crawford, S., and S. P. Goff. 1984. Mutations in *gag* proteins P12 and P15 of Moloney murine leukemia virus block early stages of infection. *J. Virol.* **49**:909-917.
13. Dimitrov, D. S., R. L. Willey, H. Sato, L.-J. Chang, R. Blumenthal, and M. A. Martin. 1993. Quantitation of human immunodeficiency virus type 1 infection kinetics. *J. Virol.* **67**:2182-2190.
14. Dorfman, T., F. Mammano, W. A. Haseltine, and H. G. Göttlinger. 1994. Role of the matrix protein in the virion association of the human immunodeficiency virus type 1 envelope glycoprotein. *J. Virol.* **68**:1689-1696.
15. Farnet, C. M., and W. A. Haseltine. 1991. Determination of viral proteins present in the human immunodeficiency virus type 1 preintegration complex. *J. Virol.* **65**:1910-1915.
16. Fischer, G., and F. X. Schmid. 1990. The mechanism of protein folding. Implications of in vitro refolding models for de novo protein folding and translocation in the cell. *Biochemistry* **29**:2205-2212.
17. Franke, E. K., and J. Luban. Unpublished data.
18. Franke, E. K., H. E. H. Yuan, and J. Luban. 1994. Specific incorporation of cyclophilin A into HIV-1 virions. *Nature (London)* **372**:359-362.
19. Gallay, P., S. Swingle, C. Aiken, and D. Trono. 1995. HIV-1 infection of nondividing cells: C-terminal tyrosine phosphorylation of the viral matrix protein is a key regulator. *Cell* **80**:379-388.
20. Gelderblom, H. R., E. H. S. Hausmann, M. Ozel, G. Pauli, and M. A. Koch. 1987. Fine structure of human immunodeficiency virus (HIV) and immunolocalization of structural proteins. *Virology* **156**:171-176.
21. Gething, M.-J., and J. Sambrook. 1992. Protein folding in the cell. *Nature (London)* **355**:33-45.
22. Goff, S. P., P. Traktman, and D. Baltimore. 1981. Isolation and properties of Moloney murine leukemia virus mutants: use of a rapid assay for release of virion reverse transcriptase. *J. Virol.* **38**:239-248.
23. Göttlinger, H. G., J. G. Sodroski, and W. A. Haseltine. 1989. Role of capsid precursor processing and myristoylation in morphogenesis and infectivity of human immunodeficiency virus type 1. *Proc. Natl. Acad. Sci. USA* **86**:5781-5785.
24. Hirt, B. 1967. Selective extraction of polyomavirus DNA from infected mouse cell cultures. *J. Mol. Biol.* **26**:365-369.
25. Hsu, H. W., P. Schwartzberg, and S. P. Goff. 1985. Point mutations in the p30 domain of the *gag* gene of Moloney leukemia virus. *Virology* **142**:211-214.
26. Karpas, A., M. Lowdell, S. Jacobson, and F. Hill. 1992. Inhibition of human immunodeficiency virus and growth of infected T cells by the immunosuppressive drugs cyclosporin A and FK506. *Proc. Natl. Acad. Sci. USA* **89**:8351-8355.
27. Katoh, I., Y. Yoshinaka, A. Rein, M. Shibuya, T. Odaka, and S. Oroszlan. 1985. Murine leukemia virus maturation: protease region required for conversion from "immature" to "mature" core form and for virus infectivity. *Virology* **145**:280-292.
28. Kim, S., R. Byrn, J. Groopman, and D. Baltimore. 1989. Temporal aspects of DNA and RNA synthesis during human immunodeficiency virus infection: evidence for differential gene expression. *J. Virol.* **63**:3708-3713.
29. Koletsky, A. J., M. W. Harding, and R. E. Handschumacher. 1986. Cyclophilin: distribution and variant properties in normal and neoplastic tissues. *J. Immunol.* **137**:1054-1059.
30. Lavalley, C., X. J. Yao, A. Ladha, H. Göttlinger, W. A. Haseltine, and E. A. Cohen. 1994. Requirement of the Pr55gag precursor for incorporation of the Vpr product into human immunodeficiency virus type 1 viral particles. *J. Immunol.* **68**:1926-1934.
31. Layne, S. P., M. J. Merges, M. Dembo, J. L. Spouge, S. R. Conley, J. P. Moore, J. L. Raina, H. Renz, H. R. Gelderblom, and P. L. Nara. 1992. Factors underlying spontaneous inactivation and susceptibility to neutralization of human immunodeficiency virus. *Virology* **189**:695-714.
32. Levy, D. N., L. S. Fernandes, W. V. Williams, and D. B. Weiner. 1993. Induction of cell differentiation by human immunodeficiency virus 1 *vpr*. *Cell* **72**:541-550.
33. Linial, M. L., and A. D. Miller. 1990. Retroviral RNA packaging: sequence requirements and implications. *Curr. Top. Microbiol. Immunol.* **157**:125-152.
34. Lu, Y.-L., P. Spearman, and L. Ratner. 1993. Human immunodeficiency virus type 1 viral protein R localization in infected cells and virions. *J. Virol.* **67**:6542-6550.
35. Luban, J., K. A. Bossolt, E. K. Franke, G. V. Kalpana, and S. P. Goff. 1993. Human immunodeficiency virus type 1 Gag protein binds to cyclophilins A and B. *Cell* **73**:1067-1078.
36. Luban, J., and S. P. Goff. 1991. Binding of human immunodeficiency virus type 1 (HIV-1) RNA to recombinant HIV-1 *gag* polyprotein. *J. Virol.* **65**:3203-3212.
37. Luban, J., C. Lee, and S. P. Goff. 1993. Effect of linker insertion mutations in the human immunodeficiency virus type 1 *gag* gene on activation of viral protease expressed in bacteria. *J. Virol.* **67**:3630-3634.
38. Maddon, P. J., J. S. McDougal, P. R. Clapham, A. G. Dalglish, S. Jamal, R. A. Weiss, and R. Axel. 1988. HIV infection does not require endocytosis of its receptor. *Cell* **54**:865-874.
39. Mammano, F., A. Ohagen, S. Høglund, and H. G. Göttlinger. 1994. Role of the major homology region of human immunodeficiency virus type 1 in virion morphogenesis. *J. Virol.* **68**:4927-4936.
40. Markowitz, D., S. Goff, and A. Bank. 1988. Construction and use of a safe and efficient amphotropic packaging cell line. *Virology* **167**:400-406.
41. Matousek, A., S. Rospert, K. Schmid, B. S. Glick, and G. Schatz. 1995. Cyclophilin catalyzes protein folding in yeast mitochondria. *Proc. Natl. Acad. Sci. USA* **92**:6319-6323.
42. Ondek, B., R. W. Hardy, E. K. Baker, M. A. Stammes, B. H. Shieh, and C. S. Zuker. 1992. Genetic dissection of cyclophilin function. Saturation mutagenesis of the *Drosophila* cyclophilin homolog *ninaA*. *J. Biol. Chem.* **267**:16460-16466.
43. Page, K. A., N. R. Landau, and D. R. Littman. 1990. Construction and use of a human immunodeficiency virus vector for analysis of virus infectivity. *J. Virol.* **64**:5270-5276.
44. Park, J., and C. D. Morrow. 1992. The nonmyristylated Pr160^{gag-pol} polyprotein of human immunodeficiency virus type 1 interacts with Pr55^{gag} and is incorporated into viruslike particles. *J. Virol.* **66**:6304-6313.
45. Paxton, W., R. I. Connor, and N. R. Landau. 1993. Incorporation of Vpr into human immunodeficiency virus type 1 virions: requirement for the p6 region of *gag* and mutational analysis. *J. Virol.* **67**:7229-7237.
46. Piatak, M., M. S. Saag, L. C. Yang, S. J. Clark, J. C. Kappes, K.-C. Luk, B. H. Hahn, G. M. Shaw, and J. D. Lifson. 1993. High levels of HIV-1 in plasma during all stages of infection determined by competitive PCR. *Science* **259**:1749-1754.
47. Pryciak, P. M., and H. E. Varmus. 1992. *Fv-1* restriction and its effects on murine leukemia virus integration in vivo and in vitro. *J. Virol.* **66**:5959-5966.
48. Reicin, A. S., S. Paik, R. D. Berkowitz, J. Luban, I. Lowy, and S. P. Goff. 1995. Linker insertion mutations in the human immunodeficiency virus type 1 *gag* gene: effects on virion particle assembly, release, and infectivity. *J. Virol.* **69**:642-650.
49. Rein, A., M. McClure, N. Rice, R. Luftig, and A. Schultz. 1986. Myristylation site in Pr65gag is essential for virus particle formation by Moloney murine leukemia virus. *Proc. Natl. Acad. Sci. USA* **83**:7246-7250.
50. Rhee, S. S., and E. Hunter. 1987. Myristylation is required for intracellular transport but not for assembly of D-type retrovirus capsids. *J. Virol.* **61**:1045-1053.
51. Rosenwirth, B., A. Billich, R. Datema, P. Donatsch, F. Hammerschmid, R. Harrison, P. Hiestand, H. Jaksche, P. Mayer, P. Peichl, V. Quesniaux, F. Schatz, H.-J. Schuurman, R. Traber, R. Wenger, B. Wolf, G. Zenke, and M. Zurini. 1994. Inhibition of human immunodeficiency virus type 1 replication by SDZ NIM 811, a nonimmunosuppressive cyclosporine analog. *Antimicrob. Agents Chemother.* **38**:1763-1772.
52. Rothman, J. E., and S. L. Schmid. 1986. Enzymatic recycling of clathrin from coated vesicles. *Cell* **46**:5-9.
53. Russel, M., and P. Model. 1986. The role of thioredoxin in filamentous phage assembly. Construction, isolation, and characterization of mutant thioredoxins. *J. Biol. Chem.* **261**:14997-15005.
54. Sambrook, J., E. F. Fritsch, and T. Maniatis. 1989. Molecular cloning: a laboratory manual, 2nd ed. Cold Spring Harbor Laboratory Press, Cold Spring Harbor, N.Y.
55. Schreiber, S. L., and G. R. Crabtree. 1992. The mechanism of action of cyclosporin A and FK506. *Immunol. Today* **13**:136-142.
56. Smith, A. J., N. Srinivasakumar, M.-L. Hammarskjöld, and D. Rekosh. 1993. Requirements for incorporation of Pr160^{gag-pol} from human immunodeficiency virus type 1 into virus-like particles. *J. Virol.* **67**:2266-2275.
57. Stammes, M. A., S. L. Rutherford, and C. S. Zuker. 1992. Cyclophilins: a new family of proteins involved in intracellular folding. *Trends Cell Biol.* **2**:272-276.
58. Stein, B. S., S. D. Gowda, J. D. Lifson, R. C. Penhallow, K. G. Bensch, and E. G. Engleman. 1987. pH-independent HIV entry into CD4-positive T cells via virus envelope fusion to the plasma membrane. *Cell* **49**:659-668.
59. Steinkasserer, A., R. Harrison, A. Billich, F. Hammerschmid, G. Werner, B. Wolf, P. Peichl, G. Palfi, W. Schnitzel, E. Mlynar, and B. Rosenwirth. 1995. Mode of action of SDZ NIM 811, a nonimmunosuppressive cyclosporin A analog with activity against human immunodeficiency virus type 1 (HIV-1): interference with early and late events in HIV-1 replication. *J. Virol.* **69**:814-824.
60. Stewart, L., G. Schatz, and V. M. Vogt. 1990. Properties of avian retrovirus particles defective in viral protease. *J. Virol.* **64**:5076-5092.
61. Strambio-de-Castillia, C., and E. Hunter. 1992. Mutational analysis of the major homology region of Mason-Pfizer monkey virus by use of saturation mutagenesis. *J. Virol.* **66**:7021-7032.

62. Sykes, K., M.-J. Gething, and J. Sambrook. 1993. Proline isomerases function during heat shock. *Proc. Natl. Acad. Sci. USA* **90**:5853–5857.
63. Thali, M., A. A. Bukovsky, E. Kondo, B. Rosenwirth, C. T. Walsh, J. Sodroski, and H. G. Göttlinger. 1994. Specific association of cyclophilin A with human immunodeficiency virus type 1 virions. *Nature (London)* **372**:363–365.
64. Trono, D. 1995. HIV accessory proteins: leading roles for the supporting cast. *Cell* **82**:189–192.
65. Wainberg, M., A. Dascal, N. Blain, L. Fitz-Gibbon, F. Boulerice, K. Numazaki, and M. Tremblay. 1988. The effect of cyclosporine A on infection of susceptible cells by human immunodeficiency virus type 1. *Blood* **72**:1904–1910.
66. Wang, C.-T., and E. Barklis. 1993. Assembly, processing, and infectivity of human immunodeficiency virus type 1 Gag mutants. *J. Virol.* **67**:4264–4273.
67. Weiss, A., R. Wiskocil, and J. Stobo. 1984. The role of T3 surface molecules in the activation of human T cells: a two stimulus requirement for IL-2 production reflects events occurring at a pretranslational level. *J. Immunol.* **133**:123–128.
68. Weiss, R., N. Teich, H. Varmus, and J. Coffin (ed.). 1984. RNA tumor viruses. Cold Spring Harbor Laboratory, Cold Spring Harbor, N.Y.
69. Wills, J. W., and R. C. Craven. 1991. Form, function, and use of retroviral Gag proteins. *AIDS* **5**:639–654.
70. Yu, X., X. Yuan, Z. Matsuda, T.-H. Lee, and M. Essex. 1992. The matrix protein of human immunodeficiency virus type 1 is required for incorporation of viral envelope protein into mature virions. *J. Virol.* **66**:4966–4971.
71. Zybarth, G., and C. Carter. 1995. Domains upstream of the protease (PR) in human immunodeficiency virus type 1 Gag-Pol influence PR autoprocessing. *J. Virol.* **69**:3878–3884.