

Effects of Bleomycin on Growth Kinetics and Survival of *Saccharomyces cerevisiae*: a Model of Repair Pathways

DEBORAH J. KESZENMAN,* VIRGILIO A. SALVO, AND ELIA NUNES

*Departamento de Biofísica, Facultad de Medicina, Universidad de la República,
General Flores 2125, Montevideo, Uruguay*

Received 23 September 1991/Accepted 6 March 1992

In order to analyze the roles of some repair genes in the processing of bleomycin-induced DNA damage and, especially, the interrelationships among the involved repair pathways, we investigated the potentially lethal effect of bleomycin on radiosensitive mutants of *Saccharomyces cerevisiae* defective in recombination, excision, and *RAD6*-dependent DNA repair. Using single, double, and triple *rad* mutants, we analyzed growth kinetics and survival curves as a function of bleomycin concentration. Our results indicate that genes belonging to the three epistasis groups interact in the repair of bleomycin-induced DNA damage to different degrees depending on the concentration of bleomycin. The most important mechanisms involved are recombination and postreplication repair. The initial action of a potentially inducible excision repair gene could provide intermediate substrates for the *RAD6*- and *RAD52*-dependent repair processes. Interaction between *RAD6* and *RAD52* genes was epistatic for low bleomycin concentrations. *RAD3* and *RAD52* genes act independently in processing DNA damage induced by high concentrations of bleomycin. The synergistic interaction observed at high concentrations in the triple mutant *rad2-6 rad6-1 rad52-1* indicates partial independence of the involved repair pathways, with possible common substrates. On the basis of the present results, we propose a heuristic model of bleomycin-induced DNA damage repair.

Bleomycin (BLM) is a radiomimetic glycopeptide antibiotic used extensively in tumor therapy (32, 48). This drug binds to DNA and through a free-radical-based mechanism produces DNA base loss and single- and double-strand breaks (43, 44). In different lines of eukaryotic cells, BLM produces inhibition of DNA synthesis (10) as well as cell cycle G₂ delay (19, 38). With phages, bacteria, and yeast cells, it was demonstrated that this drug is recombinogenic and mutagenic (11, 23, 39, 42). Analysis of BLM-induced mutagenesis in repackaged lambda phage suggests SOS repair dependence (33).

BLM-induced DNA damage in prokaryotic and eukaryotic cells is partially reparable (3, 22, 27, 40). For human fibroblasts, a long-patch mode of excision repair of BLM-induced damage was recently described (4, 5). Using haploid and diploid radiosensitive strains of *Saccharomyces cerevisiae*, Moore (22) showed that all *rad* single mutants sensitive to BLM tested, with the exception of *rad15*, are sensitive to X rays. Likewise, BLM-sensitive (*blm*) mutants exhibit cross-sensitivity to ionizing radiation and hydrogen peroxide (26). These results suggest that some aspects of the repair of BLM and ionizing radiation DNA damage in yeast cells may be similar. Furthermore, DNA ligase (the product of the *CDC9* gene) is required in the overall process of restoring full-size DNA molecules from DNA fragments produced by BLM (24, 25).

We have recently shown that BLM induces at least one error-prone type of repair in *S. cerevisiae* and that the *PSO4* (*XS9*) gene acts as a mutation-triggering factor (39). Furthermore, the combination of UV light and BLM produces different degrees of sensitization depending on dose ranges, suggesting overlapping lesion specificity of the involved repair pathways (excision and recombination) (1).

The aim of the present work is to further analyze the roles

of some repair genes in processing potentially lethal BLM-induced DNA damage and, especially, the interrelationships among the involved repair processes. Using single, double, and triple radiosensitive (*rad*) mutants defective in three known DNA repair functions (recombination, excision, and postreplication repair) (8, 9, 12, 13), we surveyed the effect of BLM on growth kinetics and survival. Our results indicate that genes belonging to the three epistasis groups interact in the repair of BLM-induced DNA damage to different degrees depending on the concentration of BLM. The most important mechanisms involved are recombination and postreplication repair. The initial action of a potentially inducible excision repair gene could provide intermediate substrates to the *RAD6*- and *RAD52*-dependent repair processes.

MATERIAL AND METHODS

Yeast strains. The haploid strains of *S. cerevisiae* used in this study were kindly provided by J. A. P. Henriques. The strains employed were wild-type XV-185-4c (*MATa ade2-1 arg4-17 his1-7 lys1-1 trp5-48 hom3-10 RAD+*); the single mutants *rad2-6*, *rad3-e5*, *rad6-1*, and *rad52-1*; the double mutants *rad2-6 rad6-1*, *rad6-1 rad52-1*, and *rad3-e5 rad52-1*; and the triple mutant *rad2-6 rad6-1 rad52-1*. The *rad* mutants were all derived from crosses of the original mutants with the wild-type strain XV-185-4c. The original source of the *rad* alleles and phenotypic analysis of all the strains were previously described (14, 29).

Since suppression of the *rad6-1* mutant is frequently observed (20, 37), UV sensitivity was tested as described by Nunes et al. (30). We obtained the expected sensitivity for a nonsuppressed *rad6-1* strain (20). Moreover, previously BLM-treated logarithmic and stationary cells of the *rad6-1* strain were exposed again to various concentrations of BLM in fresh nutrient liquid medium. Growth curves similar to those shown in Fig. 2A were obtained. These tests indicated

* Corresponding author.

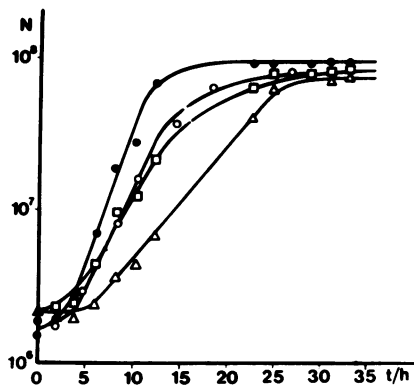

FIG. 1. Growth kinetic curves of haploid strain *RAD*⁺ cultured in liquid YED medium containing different concentrations of BLM. ●, control; ○, B1 (1 $\mu\text{g/ml}$); □, B2 (3.75 $\mu\text{g/ml}$); △, B3 (7.5 $\mu\text{g/ml}$). t/h, time (in hours).

the lack of suppression of the *rad6-1* mutant employed in this study.

Media. The liquid medium YED contained 0.5% yeast extract (Difco) and 1% dextrose (Difco). Cells were plated on YED medium (YEDA) solidified by 2% agar (Difco) (30).

BLM treatments. BLM for clinical use (Kayaku Co. Ltd., Tokyo, Japan) was employed. Stock solutions of BLM were prepared with sterile distilled water. For growth kinetic experiments, BLM was added to liquid YED medium at different concentrations (B1 = 1 $\mu\text{g/ml}$, B2 = 3.75 $\mu\text{g/ml}$, and B3 = 7.5 $\mu\text{g/ml}$) just before the inoculation of yeast cells. A preliminary test showed that higher concentrations of the drug resulted in complete growth inhibition of all strains under our experimental conditions. For survival experiments, solid YEDA medium containing BLM was prepared according to a previously described method (1, 22, 26). In short, BLM was added to cooled YEDA immediately after pouring and was gently mixed. Plates containing different

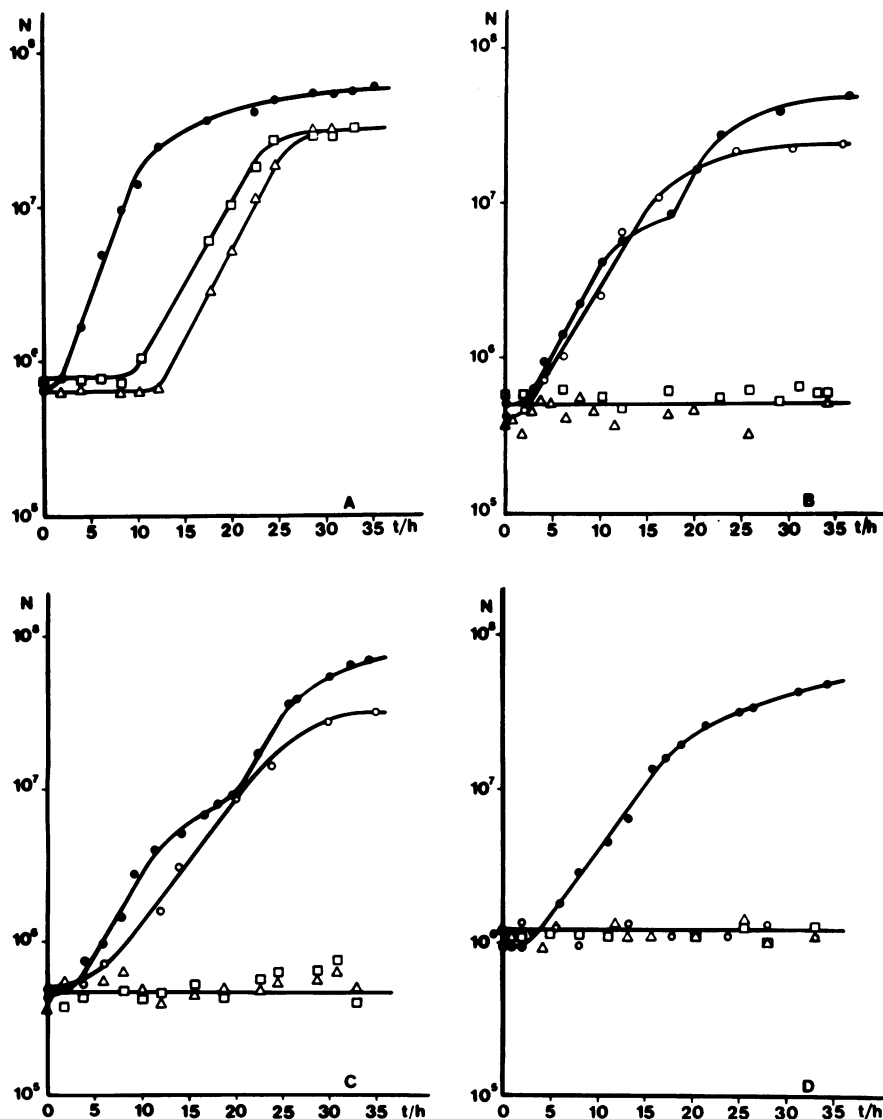

FIG. 2. Growth kinetic curves of haploid strains *rad6-1* (A), *rad52-1* (B), *rad6-1 rad52-1* (C), and *rad2-6 rad6-1 rad52-1* (D), cultured in liquid YED medium containing different concentrations of BLM. ●, control; ○, B1 (1 $\mu\text{g/ml}$); □, B2 (3.75 $\mu\text{g/ml}$); △, B3 (7.5 $\mu\text{g/ml}$). In panel A, the curve corresponding to B1 does not differ significantly from the curve corresponding to the control. t/h, time (in hours).

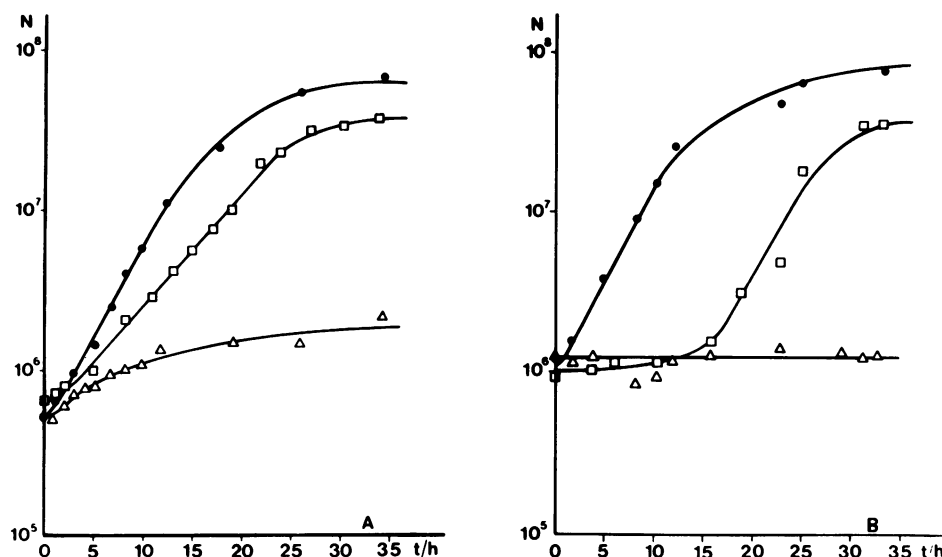

FIG. 3. Growth kinetic curves of haploid strains *rad3-e5* (A) and *rad3-e5 rad52-1* (B), cultured in liquid YED medium containing different concentrations of BLM. ●, control; □, B2 (3.75 $\mu\text{g/ml}$); △, B3 (7.5 $\mu\text{g/ml}$). The curves corresponding to B1 (1 $\mu\text{g/ml}$) do not differ significantly from the curves corresponding to the control. t/h, time (in hours).

concentrations of the drug (3.75 to 30 $\mu\text{g/ml}$) were employed. Although plates were used within 24 h after preparation, similar surviving fractions were obtained with plates used 10 days after preparation. Hence, BLM was stable during the incubation time of the experiments. Independent survival determinations showed that this BLM treatment performed in solid YEDA medium is equivalent to exposing the same cell samples in liquid YED medium containing BLM to continuous agitation for 0.4 h at 30°C and then washing and plating the cells on nutrient YEDA.

Growth kinetic assay. Growth was initiated at a cell concentration of 0.5 to 1×10^6 cells per ml by the inoculation of fresh cells (previously grown in YED to early stationary phase) in 10 ml of YED with or without BLM. Cells were grown at 30°C, pH 5.5 \pm 0.3, with continuous aeration and agitation. Growth was monitored through counting (by means of a hemocytometer) the number of cells per ml (N) as a function of the incubation time. The standard error of the counts was estimated as $\pm 4.5\%$ of N . Growth was also monitored by observing the optical density by using the corresponding calibration curves. Data from at least three reproducible experiments are given in the figures.

Survival determinations. Cultures in YED medium were initiated as described above, and cell samples in the mid-log phase of growth ($N = 10^7$ cells per ml) were collected, except for the *rad52-1* and *rad6-1 rad52-1* mutants. Cell samples of both strains in early log phase ($N = 3 \times 10^6$ cells per ml) were collected, since survival determinations performed during the partial synchronization observed during growth kinetic studies (Fig. 2B and C) were similar to those of cells in the stationary phase of growth (data not shown).

Logarithmic cell samples were diluted appropriately in sterile distilled water to give 200 to 400 viable cells per plate and were promptly spread on YEDA without and with BLM. Plating was performed in quadruplicate at each BLM concentration. Plates were incubated at 30°C for 5 to 10 days. Data from three to six experiments are given, and 95% binomial confidence limits are included in the figures.

RESULTS

Growth kinetics of cell populations. The growth curves of haploid yeast cell populations of wild-type *RAD*⁺ and single, double, and triple *rad* mutants in liquid YED medium without and with BLM are shown in Fig. 1 to 4. The number of cells per ml (N) versus time (t) was plotted on semi-log coordinates. For simplicity, experimental points were plotted up to 35 h, since no further modification in growth thereafter was observed. To analyze these growth curves quantitatively, the following kinetic parameters were calculated: the maximal number of cells per ml reached in the stationary phase of growth (N_{max}), the doubling time of the population (DT) during the exponential phase of growth, and the lag phase time (t_{lag}), which corresponds to the mean time elapsed before the onset of cell division. Table 1 summarizes the growth kinetic parameters of the strains studied cultured without BLM and in the presence of various concentrations of the drug (B2 = 3.75 $\mu\text{g/ml}$ and B3 = 7.5 $\mu\text{g/ml}$).

Differences among growth kinetic parameters of strains cultured without BLM (control samples), most probably due to different genetic backgrounds, were observed (Table 1). Hence, the growth kinetics of each strain cultured with BLM were compared with the corresponding values of the control without BLM treatment. The observed DT values of all studied strains were in accordance with those reported previously (18). As described in Materials and Methods, results indicated the lack of suppression of the *rad6-1* mutation. The *rad52-1* and the *rad6-1 rad52-1* mutants exhibited partial synchronization in the log phase of growth, thereafter growing at the same rate until entering the stationary phase (Fig. 2B and C). The reason for this partial synchronization is unknown.

The growth kinetics of all strains used in this study were modified to different degrees by continuous exposure of the strains to various concentrations of BLM. The most sensitive strain was the triple mutant *rad2-6 rad6-1 rad52-1*, since it showed no growth at any BLM concentration tested (Fig. 2D). The *rad52-1* single mutant and *rad6-1 rad52-1* double

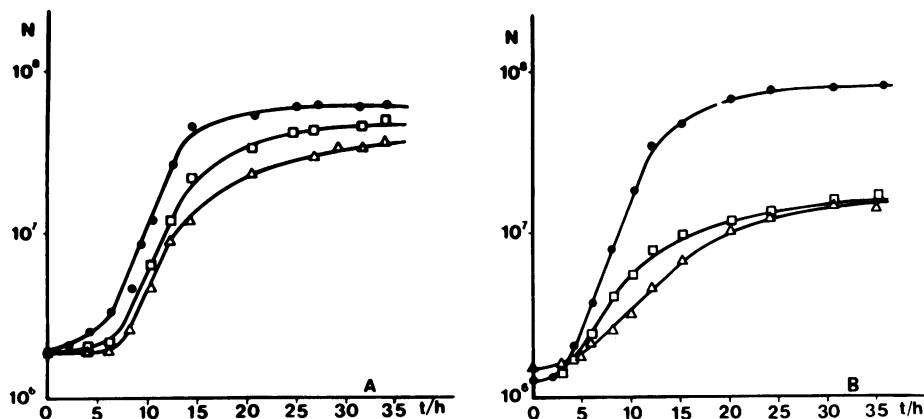

FIG. 4. Growth kinetic curves of haploid strains *rad2-6* (A) and *rad2-6 rad6-1* (B) cultured in liquid YED medium containing different concentrations of BLM. ●, control; □, B2 (3.75 $\mu\text{g/ml}$); △, B3 (7.5 $\mu\text{g/ml}$). The curves corresponding to B1 (1 $\mu\text{g/ml}$) do not significantly differ from the curves corresponding to the control. t/h, time (in hours).

mutant displayed intermediate sensitivities. In fact, the growth of both mutants was completely blocked at B2 (3.75 $\mu\text{g/ml}$) and B3 (7.5 $\mu\text{g/ml}$), and it was modified at B1 (1 $\mu\text{g/ml}$) (Fig. 2B and C). At the latter BLM concentration, the *rad6-1 rad52-1* double mutant showed a twofold increase in the *DT* and both mutants exhibited a 50% decrease in the N_{max} and no variation in the t_{lag} . Interestingly, in the presence of the drug, partial synchronization was not observed. The growth kinetics of the other strains studied were significantly modified at B2 and B3 (Fig. 1, 2A, 3, and 4). In fact, analysis of the kinetic parameters showed an increase in the *DT* and a decrease in the N_{max} (Table 1). An increase in the t_{lag} as a function of BLM concentration was observed with wild-type *RAD*⁺ (Fig. 1) and with all mutant strains that exhibited growth (Fig. 2A, 3, and 4). This increase was more significant in the *rad3-e5 rad52-1* double mutant (14-fold at B2) (Fig. 3B) and in the *rad6-1* single mutant (6-fold at B3) (Fig. 2A) than in the corresponding controls.

Survival curves to BLM. To determine independence, epistasis and/or synergistic interactions among the repair processes studied (2, 12), we measured the survival of cells continuously exposed to various concentrations of BLM.

All survival curves presented two components of different

slopes. The exception was the *rad6-1* single mutant, which showed a single exponential course.

Regarding the survival curves of the single mutants (Fig. 5), the *rad52-1* mutant showed the maximal level of sensitivity to low concentrations of BLM (0 $\mu\text{g/ml}$ \leq BLM < 15 $\mu\text{g/ml}$). For higher concentrations (15 $\mu\text{g/ml}$ \leq BLM \leq 30 $\mu\text{g/ml}$), the most important gene involved in BLM sensitivity was *RAD6*. *RAD52* had an intermediate effect. Single mutants defective in excision repair were not significantly affected by the drug.

The functional relationships among the *RAD2*, *RAD6*, and *RAD52* genes can be inferred from Fig. 6 and 7. For low BLM concentrations, the *rad6-1 rad52-1* double mutant showed an epistatic interaction between the corresponding genes, since the double mutant was as sensitive as the most sensitive single mutant. For high BLM concentrations, this double mutant exhibited a survival rate higher than that of the *rad6-1* single mutant (Fig. 6). The *rad2-6 rad6-1* double mutant was highly resistant, since no difference in survival with respect to the *RAD*⁺ strain and the *rad2-6* mutant was observed (Fig. 7). Among the examined strains, the triple mutant *rad2-6 rad6-1 rad52-1* showed the highest level of BLM sensitivity, especially at high concentrations of the

TABLE 1. Growth kinetic parameters of yeast strains cultured in the presence of various concentrations of BLM in YED medium

Strain	BLM concn ($\mu\text{g/ml}$) ^a								
	0			3.75			7.5		
	t_{lag}	<i>DT</i>	N_{max}	t_{lag}	<i>DT</i>	N_{max}	t_{lag}	<i>DT</i>	N_{max}
<i>RAD</i> ⁺	2.5	1.5	9.8	3.0	2.75	8.0	5.5	4.0	7.5
<i>rad2-6</i>	4.5	2.0	6.2	5.75	2.5	4.8	6.75	2.5	3.8
<i>rad3-e5</i>	0.75	2.75	6.6	1.5	4.25	4.0	1.5	8.0	0.21
<i>rad6-1</i>	1.5	1.75	5.3	9.0	3.0	3.1	11.5	3.0	3.1
<i>rad52-1</i>	2.0	2.75	4.8	—	0	N_0	—	0	N_0
<i>rad2-6 rad6-1</i>	2.5	2.0	8.2	2.5	3.5	1.6	4.0	5.0	1.6
<i>rad3-e5 rad52-1</i>	1.0	2.5	8.5	14.25	2.5	3.8	—	0	N_0
<i>rad6-1 rad52-1</i>	5.0	2.5	8.4	—	0	N_0	—	0	N_0
<i>rad2-6 rad6-1 rad52-1</i>	2.25	3.5	6.2	—	0	N_0	—	0	N_0

^a Parameters are explained in the text. The t_{lag} and the *DT* were measured in hours (—, $t_{\text{lag}} \rightarrow \infty$; *DT* = 0, lack of growth). The N_{max} was measured as the number of cells per ml and divided by 10^7 . N_0 is the initial number of cells in the culture per ml (see Fig. 1 to 4).

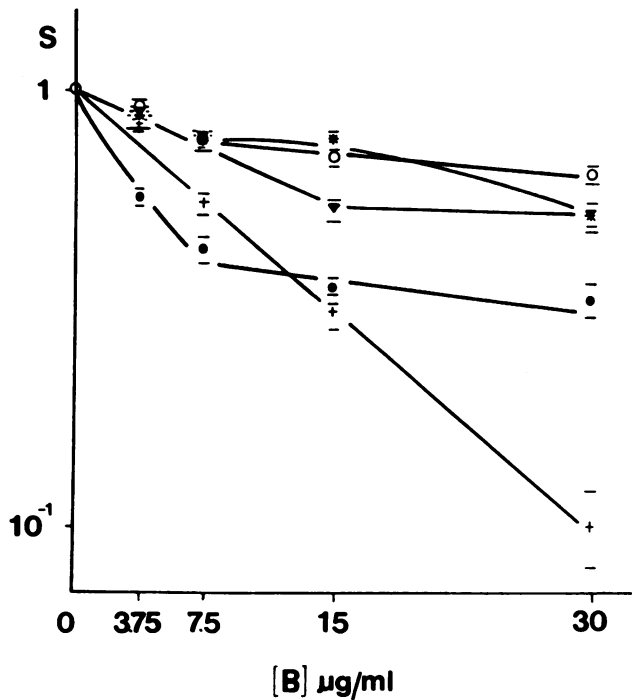

FIG. 5. Surviving fraction (S) as a function of BLM concentrations ($[B]$) of exponential-phase populations. \circ , RAD^+ ; $*$, $rad2-6$; ∇ , $rad3-e5$; $+$, $rad6-1$; \bullet , $rad52-1$.

drug (Fig. 6). In this case, the observed interaction was synergistic.

For high BLM concentrations, the sensitivity of the double mutant involving the $RAD3$ and $RAD52$ genes exhibited additivity of the sensitivities of the corresponding single mutant genes (Fig. 8).

DISCUSSION

Present results show that BLM-induced lethal DNA damage is processed by the recombinational, $RAD6$ -dependent, and excisional repair mechanisms. The function of the known epistasis groups (8, 9, 12, 13) is dynamic and depends on the BLM concentration range. According to survival and growth kinetic analysis, at low BLM concentrations ($0 \leq BLM < 15 \mu\text{g/ml}$) the most important gene involved in the repair of potentially lethal damage is $RAD52$, whereas for high BLM concentrations ($15 \mu\text{g/ml} \leq BLM \leq 30 \mu\text{g/ml}$), the $RAD6$ gene plays the most important role. It must be emphasized that the survival curves were obtained by plating on increasing concentrations of BLM, and therefore the results may not be strictly comparable to those of experiments in which treatment is given briefly and then ended.

It is noteworthy that all strains studied except $rad6-1$ exhibited biphasic survival curves with a resistant second component (Fig. 5 through 8). Mammalian cells also show biphasic survival curves with BLM (6, 47). This biphasic response could be due to the induction of repair enzymes. Interestingly, in our laboratory it has been recently shown that the resistant component of these curves depends at least in part on BLM-inducible repair (39). Moreover, the $RAD6$ gene is induced by DNA damage during the log phase of growth (21). Other possible explanations for the observed

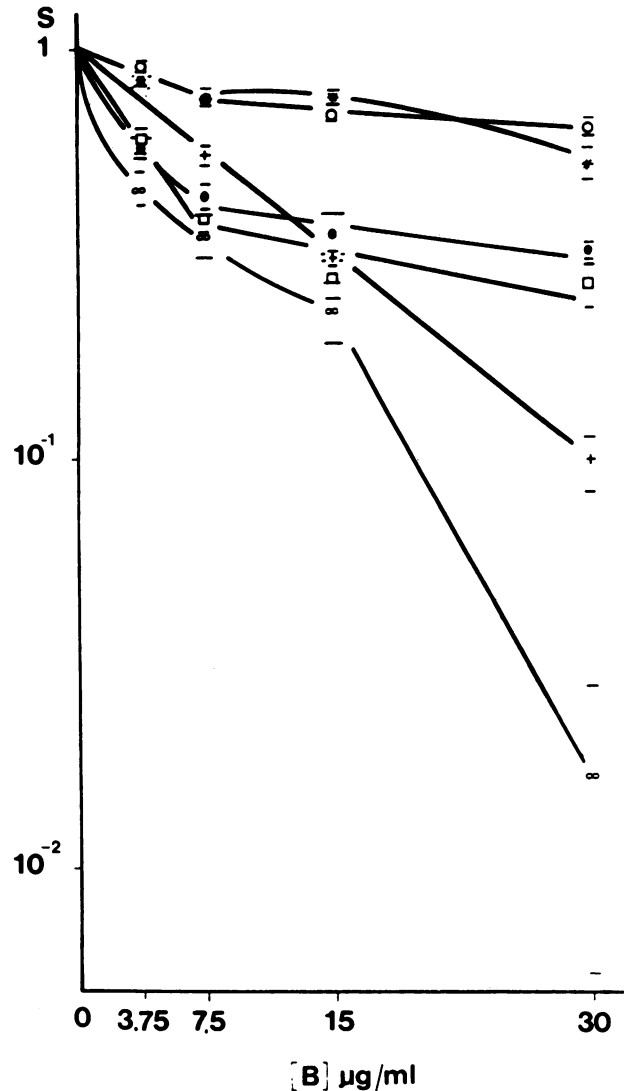

FIG. 6. Surviving fraction (S) as a function of BLM concentrations ($[B]$) of exponential-phase populations. \circ , RAD^+ ; $*$, $rad2-6$; $+$, $rad6-1$; \bullet , $rad52-1$; \square , $rad6-1 \ rad52-1$; ∞ , $rad2-6 \ rad6-1 \ rad52-1$.

resistant second component are the presence of cells with different uptakes of the drug (40) and differential target availabilities. More experimental work is necessary in order to discriminate between these possibilities.

The exponential survival curve of the $rad6-1$ mutant as well as the significant increase in the t_{lag} (Fig. 2A and 5) could be related not only to $RAD6$ postreplication repair activities (20, 34, 41) but also to its regulatory functions (20, 21, 41).

The fact that the growth of the $rad52-1$ mutant under continuous exposure to BLM is either defective or completely blocked (Fig. 2B), as well as its sensitivity with low BLM concentrations (Fig. 5), indicates the important role of the $RAD52$ gene product in processing at least part of BLM-induced lethal damage. A functional $RAD52$ gene is required for almost all mutagen-induced double-strand break repair (15, 31, 35). Our results agree with those reported previously (22) and with the described sensitivities of $rad52-1$ mutants to agents which, like BLM, induce strand

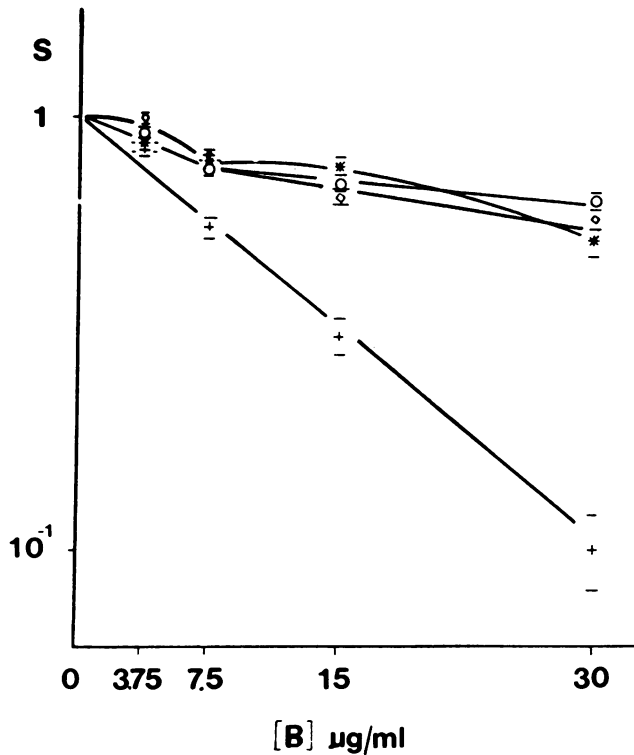

FIG. 7. Surviving fraction (S) as a function of BLM concentrations ([B]) of exponential-phase populations. \circ , *RAD*⁺; *, *rad2-6*; +, *rad6-1*; \diamond , *rad2-6 rad6-1*.

breaks. These include X rays (15, 35), neocarzinostatin (28), and phleomycin (24).

Regarding the excision-defective mutants studied, growth kinetic parameters of *rad2-6* and *rad3-e5* showed minor modifications upon BLM treatment. The latter is partially inhibited at 7.5 μg of BLM per ml (Table 1; Fig. 3A and 4A). Moreover, high survival with BLM was observed with both mutants (Fig. 5). These facts indicate a low input flow through the corresponding excision pathway in the presence of other functioning repair processes. Since the *RAD3* product has DNA helicase and ATPase activities (45, 46), this gene could have an accessory role in the repair of BLM damage, perhaps by unwinding the DNA duplex during repair.

Concerning interactions among repair processes (8, 9, 12, 13, 18), our results showed epistasis between the *RAD6* and *RAD52* genes at low BLM concentrations. In fact, according to results obtained by other authors, *RAD6* functions represent an earlier step required for repair, mutagenesis, recombination, and meiosis (16, 21, 41). *RAD6* and *RAD52* gene products acting on the same repair pathway were also reported in studies with the antitumoral agent BD-40 (29).

For high BLM concentrations, *rad6-1 rad52-1* as well as *rad2-6 rad6-1* double mutants displayed significantly higher rates of survival than the *rad6-1* single mutant (Fig. 6 and 7). This resistance could be explained by the function of alternative repair pathways. Indeed, in the double mutant *rad2-6 rad6-1*, repair of BLM-induced damage could take place through the recombinational pathway. Recent results from Schiestl et al. (37) indicated that the *SRS2* suppressor of *rad6-1* acts by channeling DNA lesions into the *RAD52*

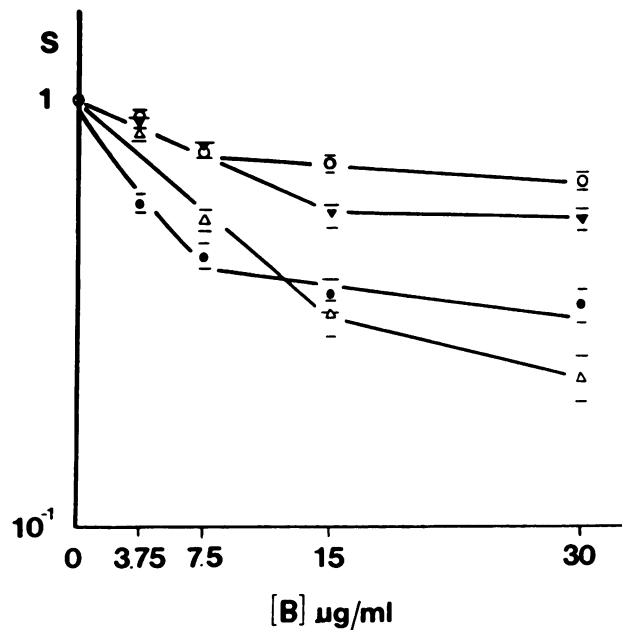

FIG. 8. Surviving fraction (S) as a function of BLM concentrations ([B]) of exponential-phase populations. \circ , *RAD*⁺; ∇ , *rad3-e5*; \bullet , *rad52-1*; \triangle , *rad3-e5 rad52-1*.

repair pathway. For the *rad6-1 rad52-1* double mutant, suppression of the *rad6* mutation seems less probable, since it depends on the *RAD52* recombinational pathway and the excision repair pathway is not required (37). The difference between the survival rate of the *rad6-1 rad52-1* double mutant and that of the triple mutant *rad2-6 rad6-1 rad52-1* is a measure of repair due to the *RAD2* gene product. It has been shown that the *RAD2* gene is inducible by BLM (36). In consequence, we could speculate that the relatively high resistance of the double mutant *rad6-1 rad52-1* is due to the initial action of the potentially inducible *RAD2* gene, which could provide intermediate substrates to be processed by later steps of the repair pathways. In this context, the *RAD24* gene is involved in excision as well as in recombination repair of UV and X-ray damage (7). *XS* genes (*XS6*, *XS8*, and *XS9 = PSO4*) are also involved in both types of repair (13, 30). Although differential repair is the most likely explanation for the results, it is not the only one possible. The high rates of survival for both double mutants could also be explained by leakiness of the corresponding mutations, genetic factors varying between the strains (e.g., auxotrophic alleles), as well as differences in their abilities to take up or metabolize BLM.

Additive interaction between the *RAD3* and *RAD52* genes at high BLM concentrations (Fig. 8) indicates the independence of these repair processes. A similar type of interaction was described for UV irradiation (2).

The combination of *rad2*, *rad6*, and *rad52* mutations confers synergistic inactivation (Fig. 7), indicating independence and possible common substrates of the involved repair processes. Interestingly, recent evidence indicates that the expression of DNA repair genes belonging to these three different epistasis groups is independently regulated (17).

We propose a model according to the facts discussed above that describes DNA repair of BLM-induced damage (Fig. 9).

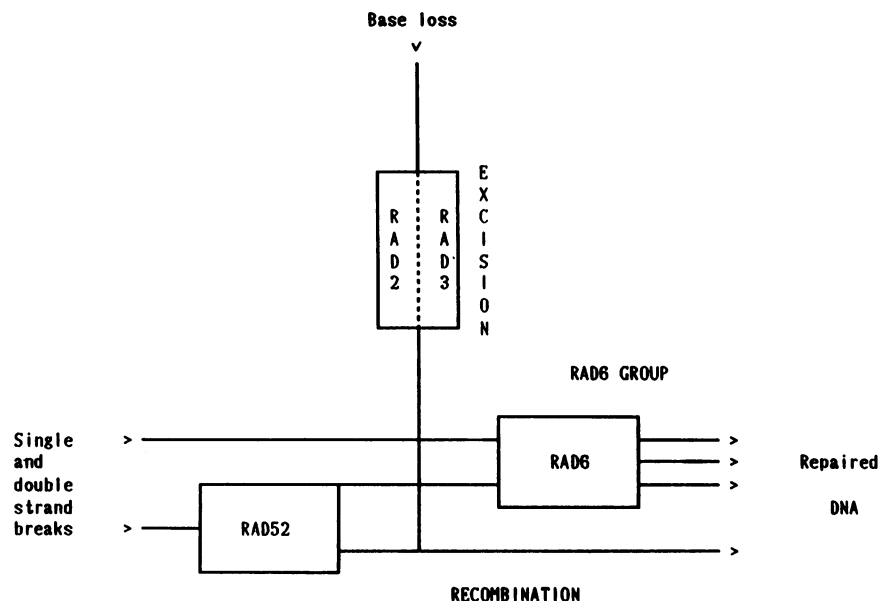

FIG. 9. Heuristic model of DNA repair pathways according to the present results. BLM-induced DNA damage (strand breaks and base loss) can be processed by the excision, recombinational, and *RAD6*-dependent repair pathways. The magnitude of repair fluxes depends on BLM concentration. The *RAD52* gene product plays a central role at low concentrations of this drug, whereas at high concentrations, the *RAD6* product is more important in processing BLM-induced DNA damage. The arrowheads in the *RAD6* group represent different categories of loci dependent on the *RAD6* gene. Upon the mutation of *RAD2* and *RAD6* genes, repair could take place through the recombinational pathway. The initial action of a potentially inducible repair gene could provide intermediate substrates to the *RAD6*- and *RAD52*-dependent repair processes. *RAD3* and *RAD52* genes are independent in processing DNA damage induced by high BLM concentrations. These three main repair processes are partially independent, with possible common steps and substrates.

ACKNOWLEDGMENTS

We are greatly indebted to J. A. P. Henriques for helpful discussions. We also thank Olga Cilento for her expert technical assistance.

REFERENCES

1. Barrios, E., E. C. Candreva, and E. Nunes. 1991. Survival of diploid yeast cells to bleomycin in combination with UV-light or hyperthermia. *Radiat. Environ. Biophys.* **30**:139-145.
2. Brendel, M., and R. H. Haynes. 1973. Interactions among genes controlling sensitivity to radiation and alkylation in yeast. *Mol. Gen. Genet.* **125**:197-216.
3. Cunningham, R. P., S. M. Saporito, S. G. Spitzer, and B. Weiss. 1986. Endonuclease IV (*nfo*) mutant of *Escherichia coli*. *J. Bacteriol.* **168**:1120-1127.
4. DiGiuseppe, J. A., and S. L. Dresler. 1989. Bleomycin-induced DNA repair in permeable human fibroblasts: mediation of long-patch and short-patch repair by distinct DNA polymerases. *Biochemistry* **28**:9515-9520.
5. DiGiuseppe, J. A., D. J. Hunting, and S. L. Dresler. 1990. Aphidicolin-sensitive DNA repair synthesis in human fibroblasts damaged with bleomycin is distinct from UV-induced repair. *Carcinogenesis (London)* **11**:1021-1026.
6. Drewinko, B., M. Patchen, L.-Y. Yang, and B. Barlogie. 1981. Differential killing efficacy of twenty antitumor drugs on proliferating and nonproliferating human tumor cells. *Cancer Res.* **41**:2328-2333.
7. Eckardt-Schupp, F., W. Siede, and J. C. Game. 1987. The *RAD24* (= *R^s₁*) gene product of *Saccharomyces cerevisiae* participates in two different pathways of DNA repair. *Genetics* **115**:83-90.
8. Friedberg, E. C. 1988. Deoxyribonucleic acid repair in the yeast *Saccharomyces cerevisiae*. *Microbiol. Rev.* **52**:70-102.
9. Game, J. C. 1983. Radiation-sensitive mutants and DNA repair in yeast, p. 109-137. In J. F. T. Spencer, D. M. Spencer, and A. R. W. Smith (ed.), *Yeast genetics. Fundamental and applied aspects*. Springer-Verlag, New York.
10. Gilmartin, M. E., S. Epner, L. Lasky, and I. M. Freedberg. 1977. Bleomycin: effects upon mammalian epidermal DNA synthesis. *Acta Dermato-Venereol.* **57**:373-378.
11. Hannan, M. A., and A. Nasim. 1978. Genetic activity of bleomycin: differential effects on mitotic recombination and mutations in yeast. *Mutat. Res.* **53**:309-316.
12. Haynes, R. H., and B. A. Kunz. 1981. DNA repair and mutagenesis in yeast, p. 371-414. In J. Strathern, E. W. Jones, and J. R. Broach (ed.), *The molecular biology of the yeast Saccharomyces. Life cycle and inheritance*. Cold Spring Harbor Laboratory, Cold Spring Harbor, N.Y.
13. Henriques, J. A. P., and M. Brendel. 1990. The role of *PSO* and *SNM* genes in DNA repair of the yeast *Saccharomyces cerevisiae*. *Curr. Genet.* **18**:387-393.
14. Henriques, J. A. P., K. V. C. L. Da Silva, and E. Moustacchi. 1985. Interaction between genes controlling sensitivity to psoralen (*pso*) and to radiation (*rad*) after 3-carbethoxypsoralen plus 365nm UV light treatment in yeast. *Mol. Gen. Genet.* **201**:415-420.
15. Ho, K. S. Y. 1975. Induction of DNA double-strand breaks by X-rays in a radiosensitive strain of the yeast *Saccharomyces cerevisiae*. *Mutat. Res.* **30**:327-334.
16. Jentsch, S., J. P. McGrath, and A. Varshavsky. 1987. The yeast DNA repair gene *RAD6* encodes a ubiquitin-conjugating enzyme. *Nature (London)* **329**:131-134.
17. Jones, J. S., and L. Prakash. 1991. Transcript levels of the *Saccharomyces cerevisiae* DNA repair gene *RAD18* increase in UV irradiated cells and during meiosis but not during the mitotic cell cycle. *Nucleic Acids Res.* **19**:893-898.
18. Keszenman-Pereyra, D. 1990. Repair of UV-damaged incoming plasmid DNA in *Saccharomyces cerevisiae*. *Photochem. Photobiol.* **51**:331-342.
19. Kimler, B. F. 1979. The effect of bleomycin and irradiation on G2 progression. *Int. J. Radiat. Oncol. Biol. Phys.* **5**:1523-1526.
20. Lawrence, C. W., and R. B. Christensen. 1979. Metabolic suppressors of trimethoprim and UV light sensitivities of *Saccharomyces cerevisiae rad6* mutants. *J. Bacteriol.* **139**:866-876.

21. Madura, K., S. Prakash, and L. Prakash. 1990. Expression of *Saccharomyces cerevisiae* DNA repair gene *RAD6* that encodes a ubiquitin conjugating enzyme increases in response to DNA damage and in meiosis but remains constant during the mitotic cell cycle. *Nucleic Acids Res.* **18**:771-778.
22. Moore, C. W. 1978. Responses of radiation-sensitive mutants of *Saccharomyces cerevisiae* to lethal effects of bleomycin. *Mutat. Res.* **51**:165-180.
23. Moore, C. W. 1978. Bleomycin-induced mutation and recombination in *Saccharomyces cerevisiae*. *Mutat. Res.* **58**:41-49.
24. Moore, C. W. 1982. Control of *in vivo* (cellular) phleomycin sensitivity by nuclear genotype, growth phase, and metal ions. *Cancer Res.* **42**:929-933.
25. Moore, C. W. 1988. Bleomycin-induced DNA repair by *Saccharomyces cerevisiae* ATP-dependent polydeoxyribonucleotide ligase. *J. Bacteriol.* **170**:4991-4994.
26. Moore, C. W. 1991. Further characterization of bleomycin-sensitive (*blm*) mutants of *Saccharomyces cerevisiae* with implications for a radiomimetic model. *J. Bacteriol.* **173**:3605-3608.
27. Moore, C. W., and J. B. Little. 1985. Rapid and slow DNA rejoining in nondividing human diploid fibroblasts treated with bleomycin and ionizing radiation. *Cancer Res.* **45**:1982-1986.
28. Moustacchi, E., and V. Favaudon. 1982. Cytotoxic and mutagenic effects of neocarzinostatin in wild-type and repair-deficient yeast. *Mutat. Res.* **104**:87-94.
29. Moustacchi, E., V. Favaudon, and E. Bisagni. 1983. Likelihood of the new antitumoral drug 10-[γ -diethylaminopropylamino]-6-methyl-5H-pyrido[3',4':4,5]pyrrolo[2,3-g]isoquinoline (BD-40), a pyridopyrroloisoquinoline derivative, to induce DNA strand breaks *in vivo* and its nonmutagenicity in yeast. *Cancer Res.* **43**:3700-3706.
30. Nunes, E., G. Brum, E. C. Candreva, and A. C. Schenberg-Frascino. 1984. Common repair pathways acting upon UV and X-ray induced damage in diploid cells of *Saccharomyces cerevisiae*. *Int. J. Radiat. Biol.* **45**:593-606.
31. Ozenberger, B. A., and G. S. Roeder. 1991. A unique pathway of double-strand break repair operates in tandemly repeated genes. *Mol. Cell. Biol.* **11**:1222-1231.
32. Povirk, L. F. 1983. Bleomycin, p. 157-181. In S. Neidle and H. Waring (ed.), *Molecular aspects of anti-cancer drug action*. Macmillan Publishers Ltd., London.
33. Povirk, L. F., and C. W. Houlgrave. 1988. Mutagenesis of bleomycin-damaged lambda phage in SOS-deficient and repair endonuclease-deficient *Escherichia coli*. *Environ. Mol. Mutagen.* **11**:461-472.
34. Prakash, L. 1981. Characterization of postreplication repair in *Saccharomyces cerevisiae* and effects of *rad6*, *rad18*, *rev3* and *rad52* mutations. *Mol. Gen. Genet.* **184**:471-478.
35. Resnick, M. A., and P. Martin. 1976. The repair of double-strand breaks in the nuclear DNA of *Saccharomyces cerevisiae* and its genetic control. *Mol. Gen. Genet.* **143**:119-129.
36. Robinson, G. W., C. M. Nicolet, D. Kalainov, and E. C. Friedberg. 1986. A yeast excision-repair gene is inducible by DNA damaging agents. *Proc. Natl. Acad. Sci. USA* **83**:1842-1846.
37. Schiestl, R. H., S. Prakash, and L. Prakash. 1990. The *SRS2* suppressor of *rad6* mutations of *Saccharomyces cerevisiae* acts by channeling DNA lesions into the *RAD52* DNA repair pathway. *Genetics* **124**:817-831.
38. Scott, D., and F. Zampetti-Bosseler. 1985. Relationships between chromosome damage, cell cycle delay and cell killing induced by bleomycin or X-rays. *Mutat. Res.* **151**:83-88.
39. Severgnini, A., O. Lillo, and E. Nunes. 1991. Analysis of bleomycin-induced mutagenic functions related to the *PSO4* (=X_{S9}) gene of *Saccharomyces cerevisiae*. *Environ. Mol. Mutagen.* **18**:102-106.
40. Sidik, K., and M. J. Smerdon. 1990. Nucleosome rearrangement in human cells following short patch repair of DNA damaged by bleomycin. *Biochemistry* **29**:7501-7511.
41. Siede, W. 1988. The *RAD6* gene of yeast: a link between DNA repair, chromosome structure and protein degradation? *Radiat. Environ. Biophys.* **27**:277-286.
42. Steighner, R. J., and L. F. Povirk. 1990. Effect of *in vitro* cleavage of apurinic/apyrimidinic sites on bleomycin-induced mutagenesis of repacked lambda phage. *Mutat. Res.* **240**:93-100.
43. Steighner, R. J., and L. F. Povirk. 1990. Bleomycin-induced DNA lesions at mutational hot spots: implications for the mechanism of double-strand cleavage. *Proc. Natl. Acad. Sci. USA* **87**:8350-8354.
44. Stubbe, J., and J. W. Kozarich. 1987. Mechanisms of bleomycin-induced DNA degradation. *Chem. Rev.* **87**:1107-1136.
45. Sung, P., L. Prakash, S. W. Matson, and S. Prakash. 1987. *RAD3* protein of *Saccharomyces cerevisiae* is a DNA helicase. *Proc. Natl. Acad. Sci. USA* **84**:8951-8955.
46. Sung, P., L. Prakash, S. Weber, and S. Prakash. 1987. The *RAD3* gene of *Saccharomyces cerevisiae* encodes a DNA-dependent ATPase. *Proc. Natl. Acad. Sci. USA* **84**:6045-6049.
47. Taylor, A. M. R., C. M. Rosney, and J. B. Campbell. 1979. Unusual sensitivity of ataxia telangiectasia cells to bleomycin. *Cancer Res.* **39**:1046-1050.
48. Umezawa, H., K. Maeda, T. Takeuchi, and Y. Akami. 1966. New antibiotics bleomycin A and B. *J. Antibiot. Ser. A* **19**:200-209.