

Basal Bodies and Associated Structures Are Not Required for Normal Flagellar Motion or Phototaxis in the Green Alga *Chlorogonium elongatum*

HAROLD J. HOOPS and GEORGE B. WITMAN

Cell Biology Group, Worcester Foundation for Experimental Biology, Shrewsbury, Massachusetts 01545

ABSTRACT The interphase flagellar apparatus of the green alga *Chlorogonium elongatum* resembles that of *Chlamydomonas reinhardtii* in the possession of microtubular rootlets and striated fibers. However, *Chlorogonium*, unlike *Chlamydomonas*, retains functional flagella during cell division. In dividing cells, the basal bodies and associated structures are no longer present at the flagellar bases, but have apparently detached and migrated towards the cell equator before the first mitosis. The transition regions remain with the flagella, which are now attached to a large apical mitochondrion by cross-striated filamentous components. Both dividing and nondividing cells of *Chlorogonium* propagate asymmetrical ciliary-type waveforms during forward swimming and symmetrical flagellar-type waveforms during reverse swimming. High-speed cinephotomicrographic analysis indicates that waveforms, beat frequency, and flagellar coordination are similar in both cell types. This indicates that basal bodies, striated fibers, and microtubular rootlets are not required for the initiation of flagellar beat, coordination of the two flagella, or determination of flagellar waveform. Dividing cells display a strong net negative phototaxis comparable to that of nondividing cells; hence, none of these structures are required for the transmission or processing of the signals involved in phototaxis, or for the changes in flagellar beat that lead to phototactic turning. Therefore, all of the machinery directly involved in the control of flagellar motion is contained within the axoneme and/or transition region. The timing of formation and the positioning of the newly formed basal structures in each of the daughter cells suggests that they play a significant role in cellular morphogenesis.

A large body of evidence has implicated the basal body as a necessary precursor to flagellum formation, even in cases where no basal bodies or centrioles exist in nonflagellated stages of the life cycle (11, 24, 31, 48, 51). The basal bodies and their associated rootlets and fibers have also been proposed to play various roles in the functioning of individual flagella and in the coordination between flagella of the same cell (10, 34, 39, 58, 59, 68), although there has been little experimental evidence in support of these roles. Clearly, the basal body is not required for flagellar movement per se, because the flagella of certain mammalian and insect sperm are motile in the absence of basal bodies (16, 17, 28, 49, 50, 69). Moreover, isolated, demembrated flagella lacking basal bodies can be reactivated (1, 5); these reactivated flagella beat with normal waveforms and even change their waveforms in response to Ca^{++} (5), the normal physiological effector (60).

To determine unequivocally whether the basal bodies have any role in flagellar movement, it would be ideal to compare the repertoire of flagellar behavior in an intact cell in the presence and absence of basal bodies. A recent report that the basal bodies separate from the flagella yet the flagella remain functional in dividing cells of *Polytoma* (25, 26) suggested to us that such a comparison may be possible in certain members of the Chlorophyceae. We report here that a similar situation occurs in the biflagellate green alga *Chlorogonium*. Prior to division, the basal bodies detach from the parental flagella, which remain motile in the absence of associated basal bodies, microtubular rootlets, and striated fibers. We have examined flagellar waveform and beat frequency in interphase and dividing cells of *Chlorogonium* and find that there is virtually no difference in the behavior of the flagella in the two cell types. Moreover, both interphase and dividing cells swim in

helices, undergo the photophobic response, and exhibit strong negative phototaxis. These results indicate that, at least in *Chlorogonium*, the basal bodies, striated fibers, and microtubular rootlets are not required for, and probably have no role in, the initiation or control of flagellar movement, or in the signal transduction and processing required for the photophobic response or phototaxis. All elements directly involved in the control of flagellar movement must therefore be located in the flagellar shaft distal to the basal body.

MATERIALS AND METHODS

Cells and Culture Conditions: *Chlorogonium elongatum* Dang. (culture #11) was obtained from the Culture Collection of Algae at the University of Texas at Austin (62). Unless otherwise stated, cells were grown in 125 ml of *Chlorogonium* growth medium composed of 80% *Chlamydomonas* medium I (56) modified to contain three times the normal amount of phosphate buffer and 20% *Euglena* medium (62) in un aerated 250 ml Erlenmeyer flasks at 25°C under a 16:8 h light:dark cycle. Partial synchrony in cell division was obtained by inoculating ~7 ml of a stationary culture into 125 ml fresh medium ~2 h before the onset of the dark period. 15 h later a mixed population containing ~15–20% dividing cells was obtained. For some experiments, cells were grown in 100% *Chlamydomonas* medium I (modified as above) continuously bubbled with a 5% CO₂-95% air mixture at 24°C. Under these conditions ~10% of the cells were dividing during the last 2 h of the dark period, when they were tested for phototaxis.

Electron Microscopy: Preparation for electron microscopy was as described previously (32), except that the initial glutaraldehyde fixation was carried out in *Chlorogonium* growth medium.

Analysis of Flagellar Waveform: For study of flagellar waveform, 15 ml of a cell culture containing both dividing and nondividing cells was centrifuged in a 15-ml conical polystyrene tube at 150 g for 3 min in a clinical centrifuge at room temperature and the excess medium removed by aspiration. The pellet was resuspended in ~0.3 ml of the remaining medium. A small aliquot of this cell suspension was placed on a clean slide and covered with a coverslip. The size of this aliquot was varied until a few cells were gently trapped between the slide and coverslip. Almost all dividing and nondividing cells retained motile flagella throughout these procedures. These cells were filmed at 155 or 309 frames s⁻¹ on Kodak Tri-X 16-mm film as described previously (33). Illumination during filming was supplied by a Chadwick-Helmuth Strobex power supply and lamp synchronized with a Redlake Locam 16-mm movie camera; all filming was done at room temperature with a Calflex heat reflection filter between the specimen and light source. When initially illuminated under these conditions, the cells underwent a transient "photophobic" response consisting of flagellar-type beating; the cells then resumed beating with a normal ciliary-type waveform. Most films thus contained sequences of cells beating with both ciliary- and flagellar-type waveforms. The films were projected at a final magnification of ~3,000 and analyzed frame by frame to determine waveform and beat frequency. Sequences in which one or both flagella dragged on the glass surface were discarded.

Analysis of Swimming Speed and Paths: To determine swimming velocities and paths, cell suspensions were placed on a clean slide and covered with a coverslip supported on two sides with petroleum jelly to give a chamber depth of 0.10–0.15 mm. The freely swimming cells were filmed at 24.2 frames s⁻¹ on Kodak 4-X 16-mm film under light levels estimated to be only 3–6% as intense as those used to record waveform. (Because the strobing rate was lower, the total estimated irradiance was 0.5% as high as that used to record waveform.) Under these conditions, cells rarely underwent the photophobic response but displayed predominantly forward swimming. The film was projected at known magnification onto graph paper and the outlines of the cells were traced every few frames. The center point of each cell was marked and a curve drawn through these points. The length of the curve was measured using a microcomputer-based morphometry package (Bioquant II, version 7.2, R & M Biometrics Co., Nashville, TN). This method underestimates the total distance traveled because movement in the third dimension is not measured. However, the resulting error is estimated at <10%.

Measurement of Phototaxis: Because cells of *Chlorogonium* grown in modified *Chlamydomonas* medium I were more phototactic than those grown in *Chlorogonium* growth medium, cells grown in the former medium were used for studies on phototaxis and eyespot position (see below). In this medium, some cells did not have flagella, but the majority of both dividing and nondividing cells were motile during the last 2 h of the dark period when they were tested for phototaxis. Cells were harvested as described above and

resuspended in modified *Chlamydomonas* medium I. Cell suspensions were placed in chambers similar to those used for filming free swimming cells, except that the chamber depth was increased to 0.15 to 0.20 mm. Cells were observed with a dim beam passed through a deep red filter (Corning # 2404, Corning Glass Works, Corning, NY) placed over the field diaphragm. The stimulating beam was provided by an American Optical Universal Focusable Illuminator (American Optical Corp. Instrument Division, P.O. Box 123, Buffalo, NY) operated at the highest intensity. The beam was focused on the slide at a 10° angle from horizontal; the distance between the illuminator and slide was 15 cm. Cells were allowed to reorient to the light for 60–75 s and then scored as swimming towards or away from the illuminator as their images passed over a linear ocular micrometer scale oriented perpendicular to the direction of the stimulating beam. Scoring was stopped after 100 cells had been scored or when only a few cells remained swimming through the center portion of the chamber. Each slide was treated as a separate experiment; data from slides in which <30 cells were scored were excluded from the analysis. In the control experiments the stimulating illuminator was turned off.

Analysis of Eyespot Position: To determine the eyespot position of swimming cells, mixed populations of dividing and nondividing cells were prepared as for the analysis of swimming speed and paths. Cell tracks were filmed by darkfield illumination on Tri-X 35-mm film and developed at ASA 1600 with Perfection XR-1 developer (Perfection Photographic Products, Inc., Los Angeles, CA). Dilute suspensions of cells were strobed at 4–10 Hz while the shutter was held open for 1–4 s. Eyespots were visible as bright refractive spots inside the dimmer track produced by the cell body (37).

To determine which of the daughter cells retained the parental eyespot, populations of cells were grown in modified *Chlamydomonas* medium I and prepared as for the waveform analysis, but viewed under darkfield illumination. Cells were scored as having two, four, or eight daughter cells, and the eyespot was scored as being in the daughter cell with the parental flagella or in another cell. Cells in which the eyespot could not be unambiguously identified, and those without motile flagella, were not scored.

RESULTS

Life Cycle of *Chlorogonium*

Chlorogonium elongatum is a biflagellate green alga closely related to *Chlamydomonas* (6, 23). In our culture, cells are spindle-shaped, 10 to 25 μm long, and possess a massive chloroplast with two pyrenoids and a prominent eyespot. *Chlorogonium*, like *Chlamydomonas*, undergoes a division process in which two or three sequential mitoses and cytokineses produce four or eight daughter cells inside the parental cell wall (Fig. 1). However, in contrast to the situation in *Chlamydomonas*, in which the parental flagella are shed or resorbed prior to division (11, 36, 40), the parental flagella of *Chlorogonium* remain attached to the anteriormost daughter cell throughout the divisions, and actively propel the dividing cells through the medium. After the final cell division, the daughter cells gradually assume the spindle shape characteristic of the genus, and the parental flagella stop beating¹ and are shed. Lastly, the parental cell wall breaks open, releasing motile daughter cells. All of these stages in the cell cycle are easily distinguished by light microscopy.

In most Chlorophyceae, the basal bodies are located near the spindle poles during mitosis (12, 19, 52, 66). Because *Chlorogonium* retains functional flagella during cell division, it was interesting to examine the structure of the flagellar bases throughout the life cycle and to determine the relationship, if any, between the basal bodies and the spindle poles.

The Interphase Flagellar Apparatus

Many random and serial sections were obtained that contained information about both the stage of the cell cycle and

¹ The flagella are shed soon after they stop beating, so that cells have immotile flagella for only an extremely small fraction of their life cycle. In the cultures used in our studies, such cells were rare relative to the total number of dividing cells.

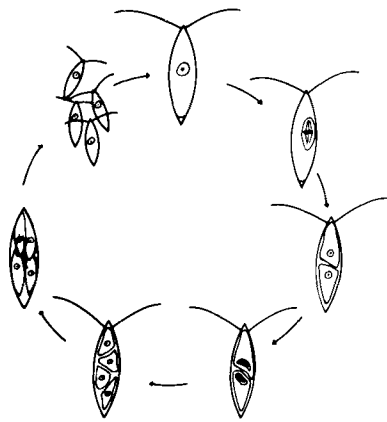

FIGURE 1 Life cycle of *Chlorogonium elongatum*. Note that the parental flagella remain attached to one of the daughter cells throughout the divisions. Although this diagram depicts the production of four daughter cells per parental cell, eight are normally produced under our culture conditions. (Parts of this diagram are modified from Hartmann [30].)

structures at the base of the flagellar apparatus. Basal bodies were always attached to the base of the flagella in nondividing cells, but were never observed in association with the parental flagella of dividing cells. Although the structural details of the *Chlorogonium* flagellar apparatus will not be emphasized in this paper, a brief description of the overall organization of the interphase flagellar apparatus is necessary for comparison with the situation in the dividing cell and in other more extensively studied organisms such as *Chlamydomonas*.

The interphase flagellar apparatus is shown diagrammatically in Fig. 2 and in Figs. 3*a* and 4. The two flagella emerge from a prominent apical papilla and project forward at an angle of $\sim 70^\circ$ from the cell axis (Fig. 3*a*). Two probasal bodies are present adjacent to the functional basal bodies (Fig. 4*h*). Four microtubular rootlets, alternately containing two and four microtubules (the latter in the 3 over 1 configuration), originate near the basal bodies and extend toward the cell posterior (Figs. 2 and 4). The basal bodies are in slightly separated but parallel planes, and are connected by a distal fiber ~ 300 nm long, 300 nm wide and 40 nm thick (Figs. 2 and 3*a*). This fiber has three major and several minor cross-striations. In lateral view, the fiber is sawhorse-shaped (Fig. 3*a*). Two additional wedge-shaped striated fibers connect the basal bodies on their proximal sides; each of these fibers also attaches to one four-membered rootlet (Fig. 2). As viewed from along the cell axis, the flagellar apparatus displays 180° rotational symmetry (Fig. 2) (20). The fine structure of the flagella, the transition regions and the basal bodies (Fig. 4) is very similar to that of *Chlamydomonas* (32, 55).

The Flagellar Base in Dividing Cells

The axonemes and the transition regions of the parental flagella of dividing cells resemble those of the nondividing cells except for electron-dense material present in the transition regions of dividing but not nondividing cells (cf. Fig. 3, *a* and *b*, and Figs. 4 and 5). However, structures proximal to the transition region are quite different. Serial sections of several flagella showed that the A- and B-tubules end at exactly the level where, in interphase cells, they would have become continuous with the triplets of the basal bodies (Figs. 3*b* and 5). Basal bodies, striated fibers, and microtubular rootlets are

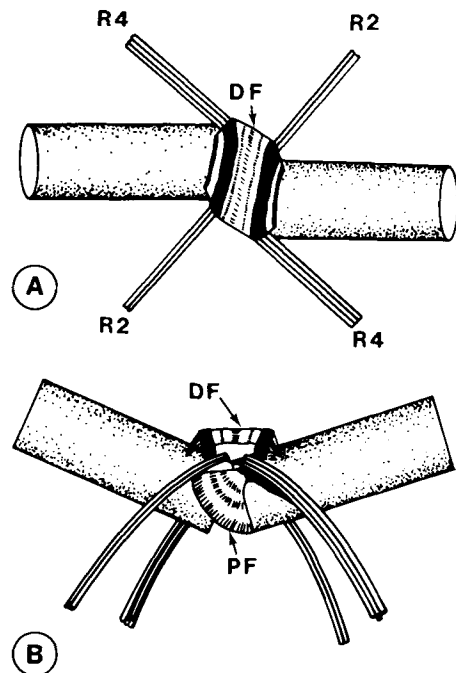

FIGURE 2 Diagrammatic representation of the interphase flagellar apparatus of *Chlorogonium*. (A) Top view; (B) side view. Both diagrams are in the correct absolute orientation (20). The basal bodies are connected by a distal striated fiber (DF) and two proximal striated fibers (PF). Four microtubular rootlets (R2, R4) extend posteriorly from the region of the flagellar apparatus. The probasal bodies and the amorphous material underlying all four microtubular rootlets have been omitted for clarity.

no longer associated with the flagella, or even present in the region surrounding the flagellar bases. Instead, a fibrous, cone-shaped structure extends from the base of the flagellum toward an extension of a large apical mitochondrion. This structure is composed of diffuse filaments, 6–9 nm in diameter, and has three or four cross-striations with a periodicity of ~ 30 nm (Fig. 3*b*). At the mitochondrion, the filaments appear to terminate on a curved, electron-dense plate ~ 15 nm thick; this plate is closely associated with the mitochondrion over most of its area and is separated from the latter by an electron-lucent layer ~ 10 nm thick (Fig. 3*b*). No comparable filamentous structure is apparent in interphase cells. In spite of the absence of the basal bodies and associated structures from the flagellar bases in the dividing cells, neither the angle nor the distance between the flagella is very different than in nondividing cells (cf. Fig. 3, *a* and *b*).

Location of the Basal Bodies during Mitosis and Cytokinesis

During mitosis the basal bodies² are no longer attached to the base of the parental flagella but are lateral to the spindle poles, about halfway between the anterior and posterior ends of the parental cell (Fig. 6). We presume that they detached from the flagella and subsequently migrated to the poles, but have not directly observed either of these processes. They remain associated with the plasma membrane and sometimes

² Although the basal bodies are now structurally similar to centrioles, we will continue to refer to them as basal bodies.

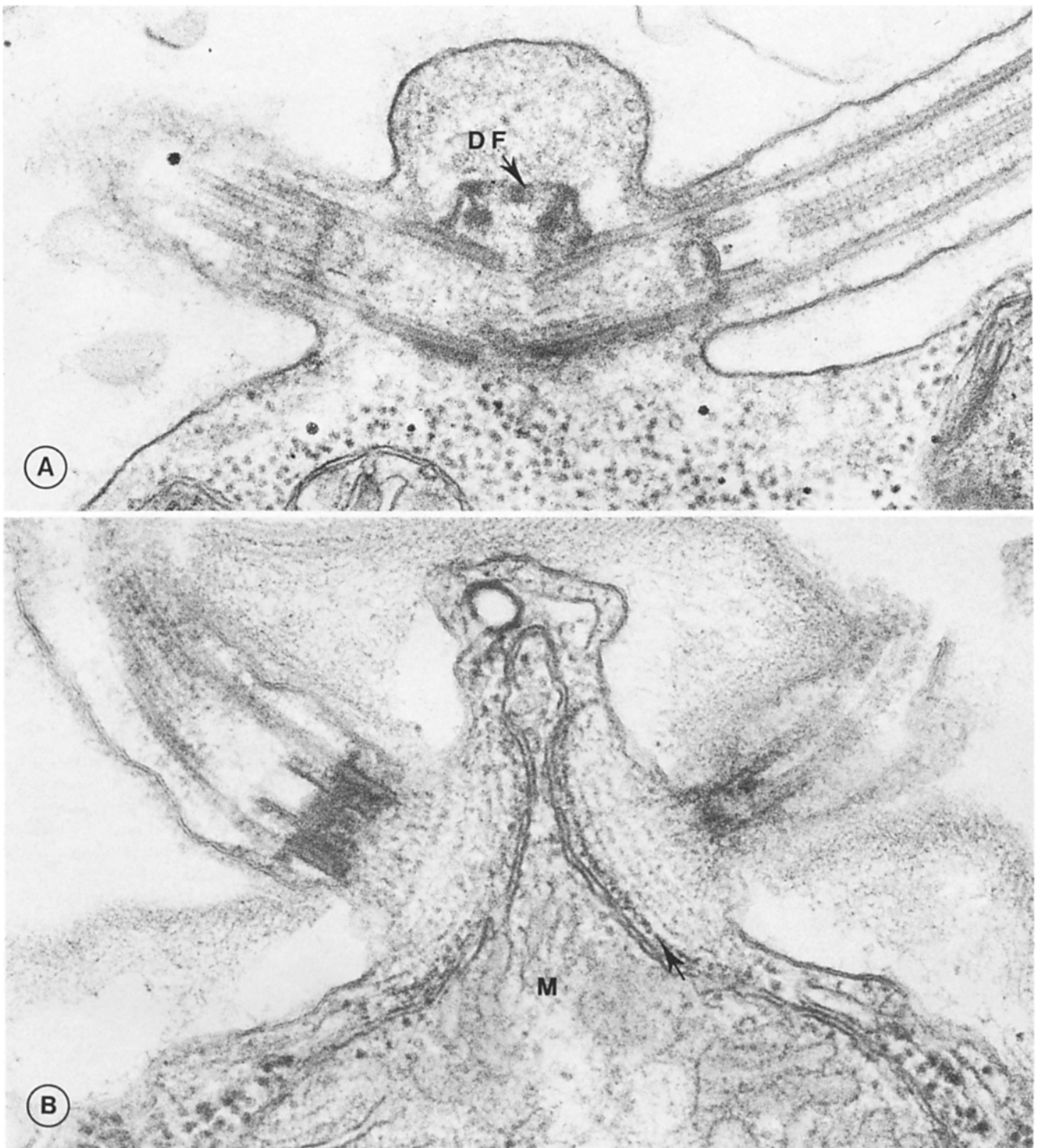

FIGURE 3 Flagellar apparatus of nondividing (A) and dividing (B) cells of *Chlorogonium*. (A) The basal bodies of the nondividing cell are connected by a distal striated fiber (DF). The proximal striated fibers and microtubular rootlets are not present in this section but were observed in adjacent sections. (B) In dividing cells, basal bodies are no longer present at the proximal end of the parental flagella; rather a fibrous component with several cross-striations connects the transition region to an electron dense plate (arrow) associated with an extension of a large apical mitochondrion (M). The striated fibers and microtubular rootlets are also gone from this area. $\times 85,000$.

appear to be initiating growth of new flagella (Fig. 6), although new flagella are not actually formed until completion of the final mitosis. At this stage, the members of each basal body pair are in close proximity to one another and are connected

by a structure similar or identical to the distal striated fiber (Fig. 6); proximal striated fibers have not been observed. Because one pair of morphologically mature basal bodies is associated with each mitotic pole, basal body elongation and

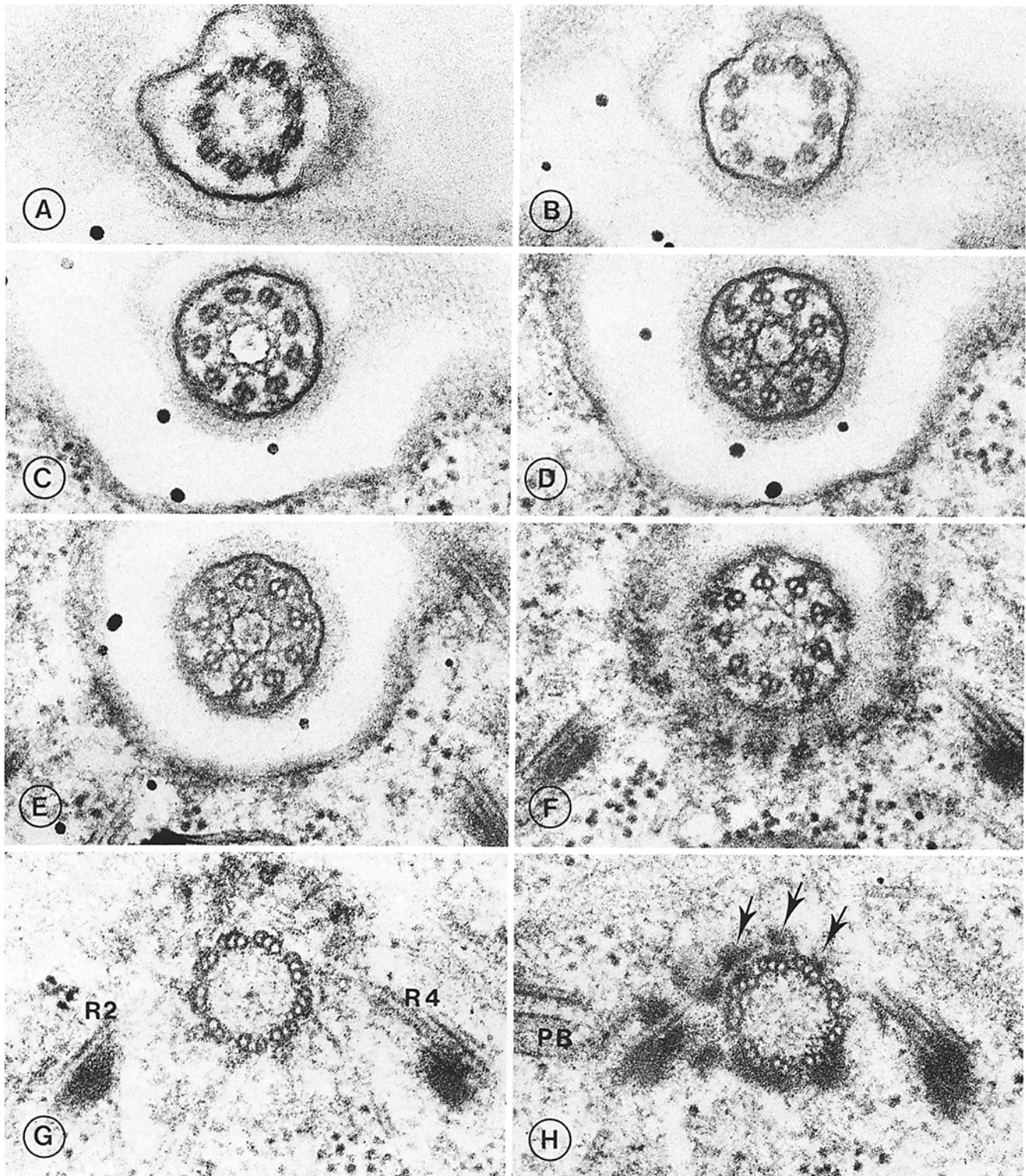

FIGURE 4 Consecutive serial cross sections of the base of a flagellum in a nondividing cell. Note the presence of the microtubular rootlets (R2, R4 in G) and the probasal body (PB in H). The arrows indicate the site of attachment of the distal striated fiber to the basal body. Although the sections are arranged from distal to proximal, each cross section is printed in the conventional manner (i.e., as if looking outward from within the cell). $\times 89,000$.

distal striated fiber formation must occur prior to each division. Microtubular rootlets are also associated with the basal bodies, although neither the number of rootlets nor their morphology has been determined.

In addition to the two basal bodies connected by the striated fiber, two probasal bodies, initially composed of singlet microtubules, are also present near the pole (results not shown). Thus, replication of the basal bodies in *Chlorogonium* occurs

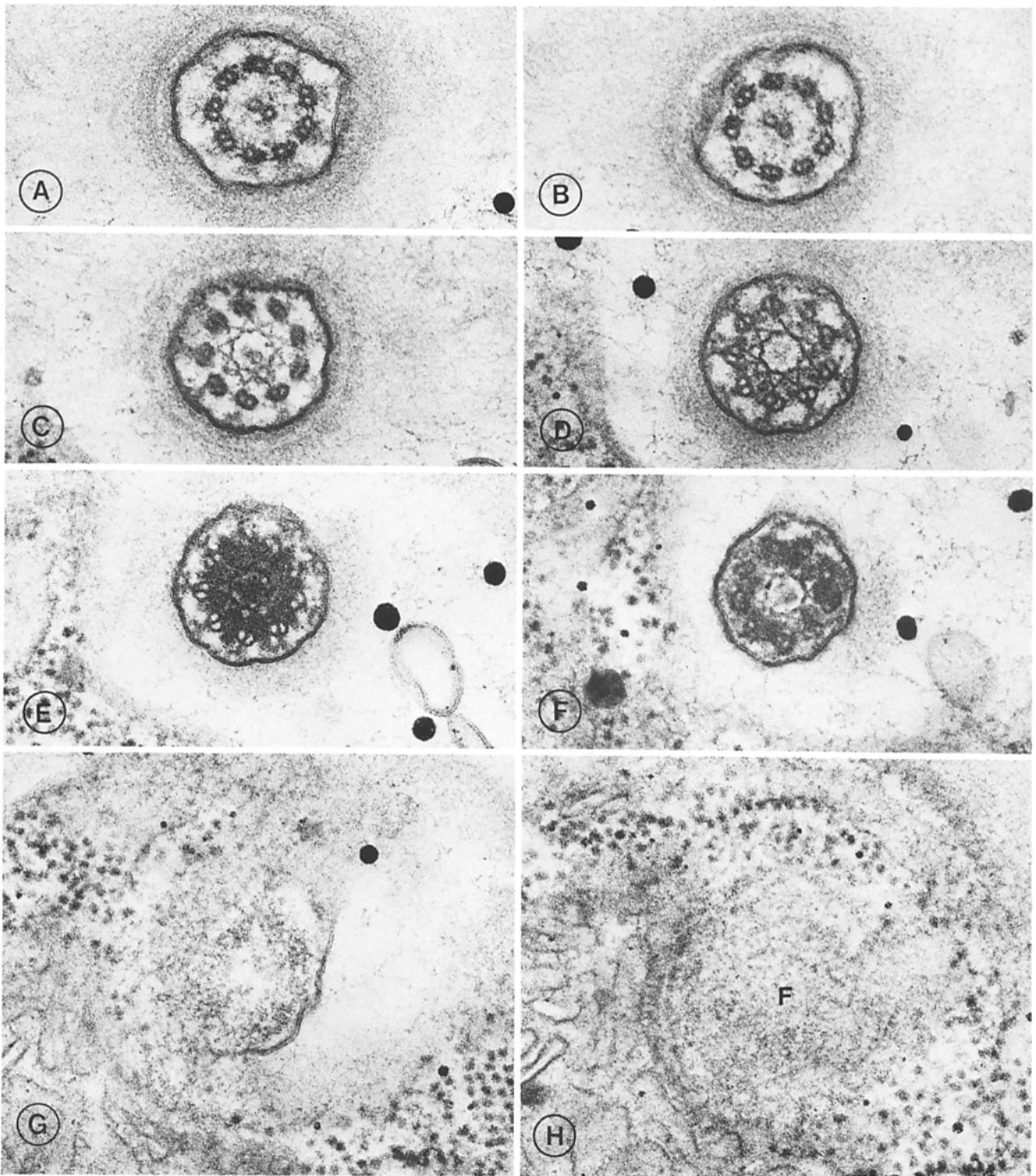

FIGURE 5 Consecutive serial cross sections of the base of a parental flagellum in a dividing cell. Note that the axoneme (A and B) and transition regions (C-F) appear similar to those of the flagellum in the nondividing cell except that the transition region is filled with electron dense material (E and F). The basal body is absent, and the peripheral flagellar microtubules terminate exactly at the level where they would be continuous with the basal body triplets in an interphase cell (cf. F, G here and in Fig. 4). The filamentous component (F in panel H) extending down into the cell from the transition region appears as a compact, fibrous structure, more or less circular in cross section; ribosomes are excluded from the area in which the filaments are found. Microtubular rootlets and striated fibers are no longer observed in the apical region of the cell. $\times 89,000$.

much earlier than in *Chlamydomonas*, where probasal bodies are reported to first form after cell division (29), and do not become visible in thin section until just before the next division (11, 55).

After the mitotic division, the basal bodies are invariably located on the sides of the daughter cells facing the center of the original (parental) cell (Fig. 7). Thus, in the daughter cell retaining the parental flagella, the flagella and basal bodies

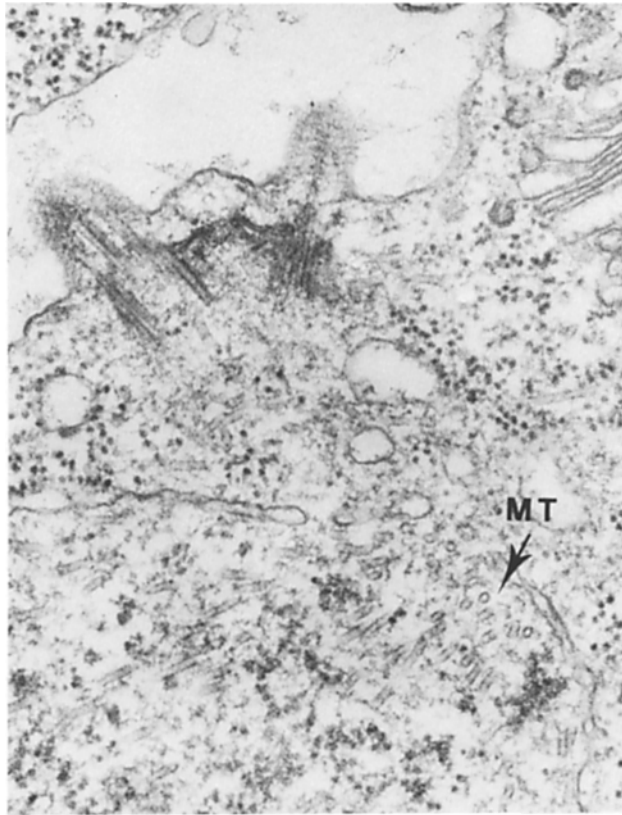

FIGURE 6 Basal bodies lateral to the spindle pole during mitosis. Note that the basal bodies are connected by a distal striated fiber. Two probasal bodies and at least two rootlets were present in adjacent sections (not shown). MT, spindle microtubules. $\times 46,000$.

are on opposite sides of the cell. The basal bodies are still closely associated with the plasma membrane and remain connected by a striated fiber. All four microtubular rootlets are present (not shown). Numerous cytoplasmic microtubules radiate away from the region of the basal bodies. These latter microtubules comprise the phycoplast (52), which predicts the plane of cytoplasmic cleavage.

Flagellar Motion in Dividing and Nondividing Cells

The parental flagella of virtually all dividing *Chlorogonium* cells remain active, despite the fact that they are no longer associated with basal bodies, microtubular rootlets, or striated fibers. Therefore, a comparison of flagellar motion in dividing and nondividing cells should indicate whether the functioning of the flagella is in any way impaired by the absence of these structures.

The flagella of *Chlorogonium*, like those of *Chlamydomonas* (8, 9, 33, 35, 55, 60), beat with an asymmetrical ciliary-type beat during normal forward swimming. This ciliary-type waveform consists of an effective stroke followed by a recovery stroke. The flagella of dividing and nondividing *Chlorogonium* beat with apparently identical ciliary waveforms (Figs. 8 and 9). The overall range of frequencies was from 9–60 Hz (number of cells, $n = 29$) in the nondividing and 9–40 Hz ($n = 9$) in dividing cells. The difference in frequencies is statistically significant (rank-sum test, 95% level of confidence), but the beat frequencies of dividing and nondividing cells overlap greatly. The flagella of dividing and nondividing cells beating at 9–20 Hz generally had relatively long effective

strokes, with the flagella tips tracing an arc of 60–90°; at frequencies between 20 and 40 Hz the flagella tips generally traced a path over 35–75° in both cell types (cf. dividing cells in Figs. 8 and 9). At low beat frequencies, the principal bend was almost completely formed before it propagated along the flagellum, but at frequencies above 35 Hz this bend often propagated before it was fully formed; as a result, the beat cycle was no longer divided into separate effective and recovery phases. These rapidly beating flagella often alternated between periods of ciliary- and flagellar-type beating and thus may have been on the border between the two beat patterns. For any given frequency, waveforms of the dividing and nondividing cells are virtually identical.

In both dividing and nondividing cells beating with a ciliary-type waveform, one flagellum beats more slowly than the other (Figs. 8 and 9). The slower flagellum beat 86.2% ($n = 10$, $SD = 7.73$) as rapidly as the other flagellum in nondividing cells, and 87.7% ($n = 7$, $SD = 7.80$) as rapidly in dividing cells. This difference is not statistically significant ($t = 0.392$, 95% level of significance). The relative difference in beat frequencies of the two flagella remained approximately constant over a large range of frequencies and therefore appears to be independent of the rate of beat. The difference between beat frequencies of the two flagella may form the basis for helical swimming (see below and reference 37).

When cells of *Chlorogonium* are subjected to a step-up in light intensity of sufficient magnitude, the cells underwent a transient “photophobic” response in which the flagella propagated symmetrical flagellar-type waves for one to several seconds, resulting in backwards swimming. Both dividing and nondividing cells underwent this response, and the resulting waveform appears identical in the two cell types (Fig. 10). During the response, the flagella of nondividing cells beat at 53.2 Hz ($n = 38$, $SD = 8.70$), whereas those of dividing cells beat at 56.1 Hz ($n = 13$, $SD = 5.81$). The frequency of beat in the two cell types is not significantly different ($t = 1.15$, 95% level of significance). In most cases the flagella of both dividing and nondividing cells beat synchronously during the photophobic response (Fig. 10), although asynchrony often occurred at the beginning and end of the response. Occasionally, in both cell types, the flagella beat out of phase through part or all of the photophobic response. Even in these cases the frequency of beat was similar in the two flagella.

The above results indicate that the absence of attached basal bodies and their associated structures does not prevent the flagella of dividing *Chlorogonium* cells from beating with normal waveforms and frequencies. The structures are not necessary for the transition from ciliary- to flagellar-type beating or vice versa, and they apparently do not influence coordination between the two flagella under our conditions.

Phototaxis in Dividing and Nondividing *Chlorogonium*

Despite the apparent lack of influence of the basal bodies, striated fibers and microtubular rootlets on the above parameters of flagellar movement, it is possible that one or more of these structures is necessary for the cell to carry out normal tactic responses.³ To investigate this, we compared phototaxis

³ Presumably, phototaxis in *Chlorogonium*, as in *Chlamydomonas* (7, 37), involves an abrupt change in swimming direction brought about by a differential behavior of the two flagella. This differs from the photophobic response, in which the two flagella transiently switch to a flagellar-type waveform that results in backwards swimming.

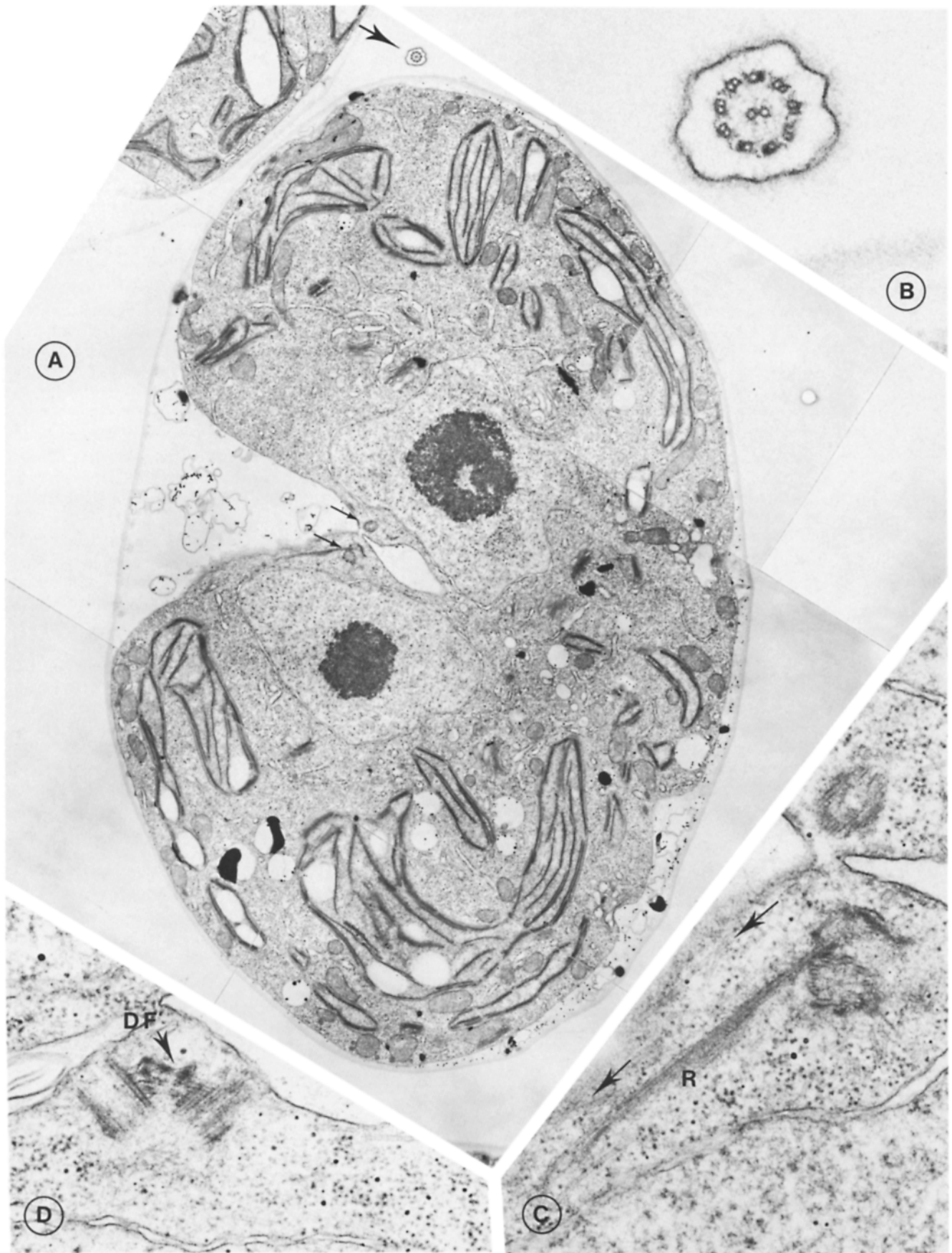

FIGURE 7 (A) Dividing *Chlorogonium* cell. A parental flagellum can be seen at top (arrow) and, at higher magnification, in B. In other sections, this flagellum was observed to insert into the upper end of the cell. The basal bodies (small arrows) are near the cleavage furrow on the opposite side of the nucleus from the parental flagella. (C) An enlargement of the basal bodies and one microtubular rootlet (R) of the dividing cell. Phycoplast microtubules can be seen just above the rootlet (arrows); these microtubules are less electron dense than those of the rootlet. (D) A pair of basal bodies connected by a distal striated fiber (DF) in another dividing cell. (A) $\times 9,900$; (B) $\times 77,000$; (C) $\times 49,000$; (D) $\times 47,000$.

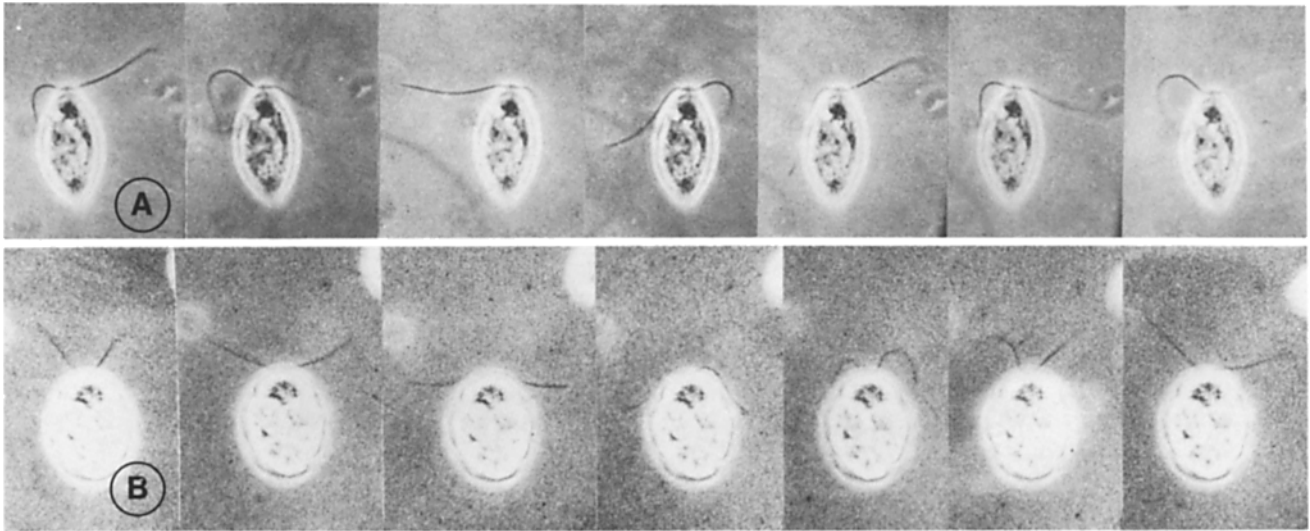

FIGURE 8 Slow ciliary-type beating in *Chlorogonium*. Note the similarity in waveform and frequency between the nondividing (A) and dividing cell (B). In the dividing cell, eight daughters are present within the parental cell wall. The right flagellum is beating more rapidly in each case. (A) $\times 810$; (B) $\times 550$. Every third frame of a movie sequence taken at $156 \text{ frames s}^{-1}$.

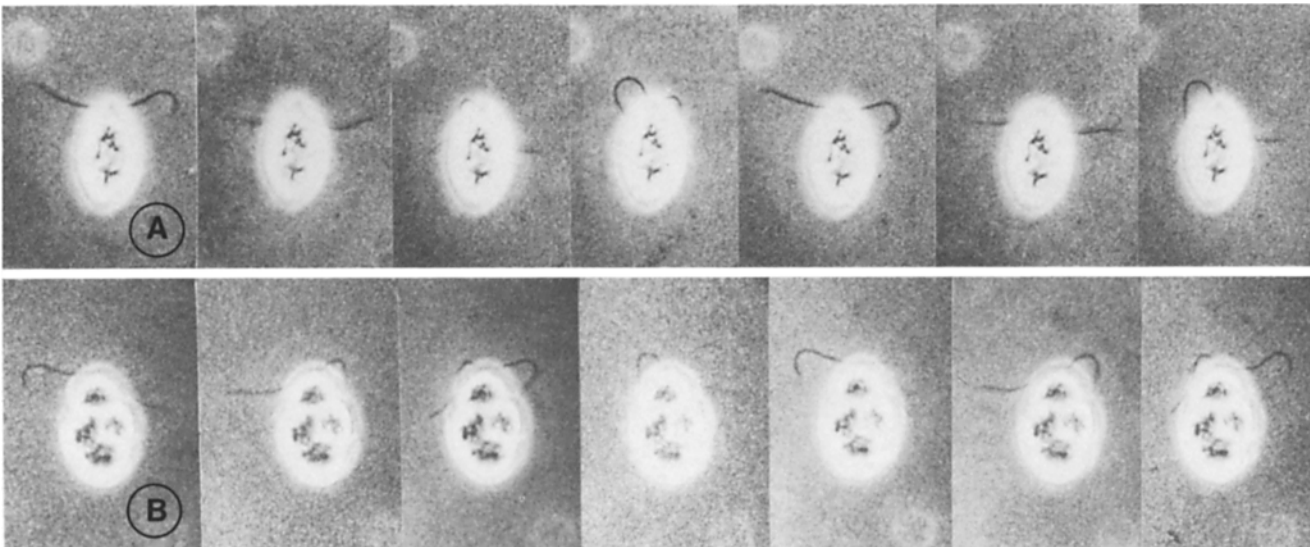

FIGURE 9 Rapid ciliary-type beating in *Chlorogonium*. Both nondividing (A) and dividing cells (B) can undergo more rapid beating with a somewhat shorter effective stroke. The dividing cell has undergone two rounds of mitosis to yield four daughter cells. The left flagellum in A and the right flagellum in B is beating more rapidly. (A) $\times 650$; (B) $\times 640$. (A) Every second frame of a movie sequence taken at $309 \text{ frames s}^{-1}$. (B) $156 \text{ frames s}^{-1}$.

in dividing and nondividing cells.

In our phototaxis assays, populations of *Chlorogonium* containing both dividing and nondividing cells were placed under the microscope, and the direction of swimming of individual cells was observed by red light in the presence and absence of a white stimulus beam coming from the side (see Materials and Methods). In the presence of the stimulus beam, $\sim 95\%$ of both dividing and nondividing cells swam away from the light source, indicating that both types of cells were strongly negatively phototactic (Fig. 11). In contrast, under control conditions (absence of stimulus beam), $\sim 50\%$ of both types of cells swam toward and 50% away from the light source, as would be expected if the cells' swimming paths were randomly oriented. These results clearly show that, under our conditions, neither basal bodies, striated fibers, nor microtubular rootlets are required for phototaxis.

Because dividing cells of *Chlorogonium* were phototactic, it was of interest to determine the fate of the eyespot during the cell divisions. Nondividing cells each have a single eyespot that is located at the periphery of the cell about one-third of the way down the cell from its anterior end and just out of a plane running through the two flagella; the eyespot is readily visible as a bright spot under darkfield illumination. During the first mitosis, the eyespot passes to the daughter cell containing the parental flagella $\sim 99\%$ ($n = 100$) of the time. Following the second round of mitosis, the eyespot is in the cell containing the parental flagella in 80% of the cases ($n = 100$). However, after the third mitosis, only $\sim 9\%$ ($n = 100$) of the cells retaining the parental flagella also receive the eyespot. Small refractile structures that may be developing eyespots are occasionally visible in the daughter cells, particularly after the second and third mitoses.

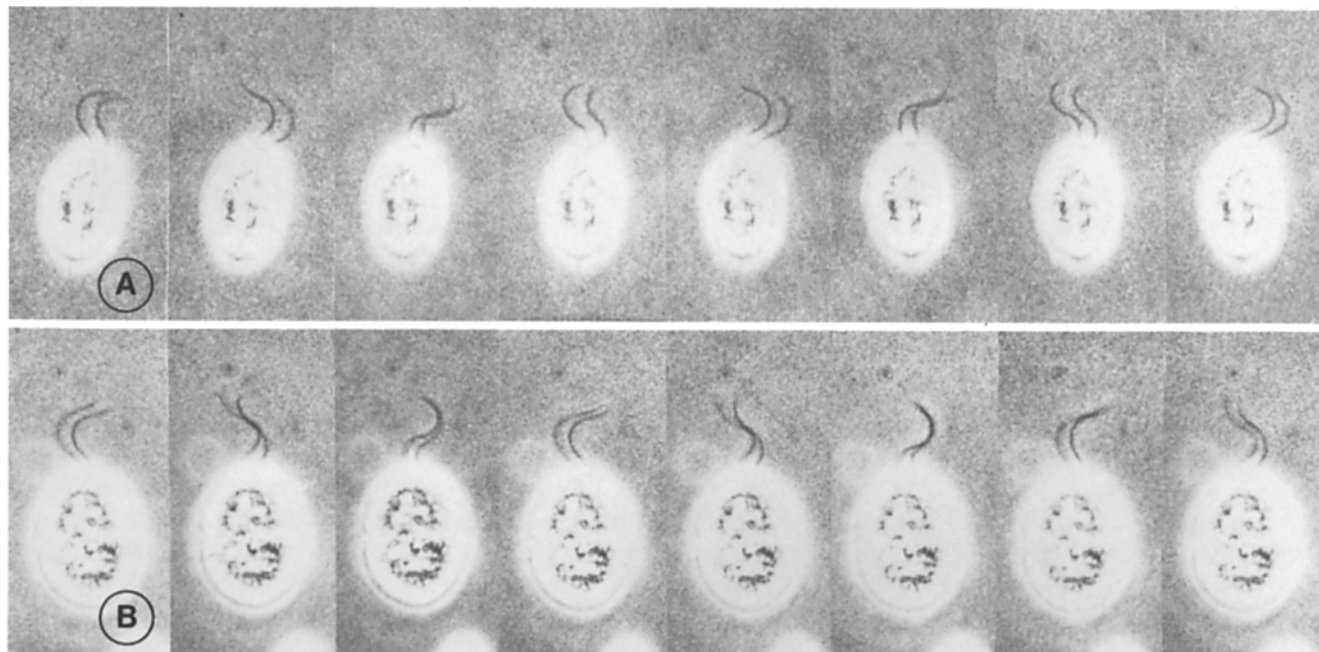

FIGURE 10 Flagellar-type beating in nondividing (A) and dividing (B) *Chlorogonium* cells. The waveform and beat frequency is similar in the two cell types. In both cells the two flagella are beating in synchrony. The dividing cell has undergone one mitosis (compare with Fig. 7). (A) $\times 660$; (B) $\times 670$; both are every third frame of movie sequences taken at $156 \text{ frames s}^{-1}$.

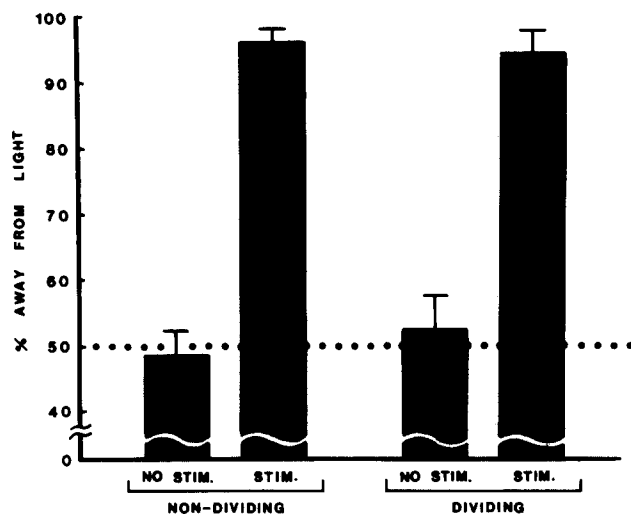

FIGURE 11 Phototaxis in dividing and nondividing cells of *Chlorogonium*. Cells were observed under dim red light and scored as swimming toward or away from the stimulating light source when the latter was on (STIM.) or off (NO STIM.) (see Materials and Methods). The dotted line represents the value expected if the direction of swimming was random.

Swimming Speed and Swimming Path in Dividing and Interphase Cells

The basal bodies have been proposed to firmly anchor the flagella to the cell body so that the flagella can effectively propel the cells through the medium. If this is true, it is possible that, even though flagellar waveform and beat frequency are similar in *Chlorogonium* in the presence and absence of basal bodies, the swimming path or swimming speed might be different. To investigate this, we compared the swimming paths and swimming speeds of dividing and

nondividing cells from the same population. All observation and filming was done under low light conditions to reduce the possibility that the illumination might affect the results. Dividing and nondividing cells swam in similar helical paths with frequent turns. Nondividing cells swam at an average speed of $88.3 \mu\text{m s}^{-1}$ ($n = 54$, $\text{SD} = 20.8$), whereas dividing cells swam at $\sim 63.9 \mu\text{m s}^{-1}$ ($n = 40$, $\text{SD} = 10.7$). Although this difference is statistically significant ($z = 7.41$, 95% level of confidence), dividing cells swam almost as rapidly as the nondividing cells and the difference may be due in part to a difference in the average size of dividing and nondividing cells (see Discussion). It should be noted that the similarities in swimming paths and swimming speeds indicate that the similarities in waveform observed under higher light levels (see above) probably also extend to the lower light levels used here.

In most of the tracks of nondividing cells recorded under darkfield illumination, the eyespot was on the outside of the helix; in a few cases the eyespot faced the inside of the helix. Determination of the eyespot position in tracks of dividing cells was more difficult because these cells often contained multiple refractile bodies which could be confused with the parental eyespot. In most tracks of dividing cells where the eyespot could be unambiguously identified, it was located on the outside of the helix, but cases were also observed in which the eyespot faced the inside for some or all of the track. In at least one dividing cell, the eyespot was on the outside of the helix for part of the track and on the inside of the helix in another portion of the track; these portions were separated by a region of track without a clearly defined helix. The significance of these observations will be discussed below.

DISCUSSION

The flagellar apparatus of interphase *Chlorogonium* is structurally similar to that of interphase *Chlamydomonas* (27, 33,

55). During division, the basal bodies of *Chlorogonium* are no longer present at the bases of the flagella but are lateral to the spindle poles, as is also the case in dividing cells of *Chlamydomonas* (12, 66). However, in contrast to *Chlamydomonas*, but as in some other chlorophycean species (23, 25, 26), the parental flagella—now lacking basal bodies, striated fibers, and microtubular rootlets—remain motile and move the dividing cells through the medium. Consequently, by comparing flagellar behavior and cell movement in dividing and nondividing *Chlorogonium* cells, we have been able to investigate whether the basal bodies and their associated structures have any direct influence on flagellar movement.

The flagella of dividing *Chlorogonium* have a waveform qualitatively indistinguishable from that of nondividing cells in both the ciliary-type beating mode characteristic of forward swimming and the flagellar-type beating mode characteristic of reverse swimming. The frequency of the flagellar-type beat is the same in both dividing and nondividing cells, and although the frequency ranges of the ciliary-type beat are statistically different in the two cell types, the ranges are largely overlapping. Further, the coordination of the flagella appears to be the same in both cell types; the flagella are usually synchronous during flagellar-type beating and asynchronous during ciliary-type beating. The similarity of waveform, beat frequency, and flagellar coordination in nondividing and dividing cells is confirmed by the similarity in swimming paths of the two cell types. These results show that basal bodies, striated fibers, and microtubular rootlets are not required for the initiation or maintenance of normal waveforms and beat frequencies, even in an organism that possesses these structures for most of its life cycle.

Dividing cells of *Chlorogonium* also undergo normal photophobic and phototactic responses, indicating that the basal bodies and their associated structures play no direct role in either the responses per se or in transduction of the signal(s), which initiates these responses. These results confirm and extend our earlier conclusion, based on study of a *Chlamydomonas* mutant lacking normal striated fibers and microtubular rootlets (33), that the fibers and rootlets are not involved in the photophobic response.

Minor differences were observed in the range of beat frequency and rate of progression in forward swimming nondividing and dividing *Chlorogonium* cells. Assuming that the observed difference in beat frequency range is real and not an artifact of inadequate sample size, the difference might reflect physiological differences in the two cell types, e.g., differences in nucleotide or specific ion concentrations. It seems unlikely that such a difference would be directly related to the presence or absence of basal bodies. The difference in average swimming speed in the two cell types may be in part a reflection of the generally lower beat frequency of dividing cells. Moreover, the nondividing cells had a smaller average size than the dividing cells, and the smaller cells of both cell types tended to swim faster (results not shown); this difference in average size between the two cell types could account for most if not all of the difference in their swimming speed. We cannot rule out the possibility that, compared with the flagella of nondividing cells, the flagella of dividing cells are less firmly anchored to the cell body and are therefore less efficient in propelling the cells forward, but such a hypothesis is not necessary to account for our observations.

The observations that nondividing and dividing *Chlorogonium* have similar photophobic and phototactic responses are

particularly interesting. In chlorophycean cells like *Chlamydomonas* and *Chlorogonium*, phototactic steering must involve a differential behavior of the two flagella, i.e., the two flagella must respond differently to the events following photostimulation (37, 45). Studies on demembrated models of *Chlamydomonas* (37) and *Chlorogonium* (Hoops, H. J., and G. B. Witman, unpublished results) have shown that the two axonemes respond differently to submicromolar levels of Ca^{++} , and it has been proposed that this difference may form the basis for phototactic turning (37). However, whether the difference in behavior of the two axonemes is due to inherent differences in the axonemes themselves, or is determined by extra-axonemal structures such as the basal bodies or the striated fibers, was not determined. Our finding that dividing cells of *Chlorogonium* exhibit normal phototaxis in the absence of basal bodies and striated fibers now provides strong evidence that the structural and biochemical basis for the differential response of the flagella is contained within the flagella shaft distal to the basal body. These results, combined with our previous observations on *Chlamydomonas*, suggest that there are biochemical differences between the axonemes and/or transition regions of the two flagella.

In *Chlorogonium*, as in *Chlamydomonas* (18, 33), one flagellum usually beats faster than the other in the ciliary-type beating mode. Although the optics used in our films have not yet allowed us to identify the faster beating flagellum relative to the eyespot, the observation that the eyespot usually faces the outside of the helix suggests that it is usually the *cis*-flagellum (the flagellum closest to the eyespot) (37). However, in some nondividing and dividing cells of *Chlorogonium*, the eyespot was on the inside of the helix, suggesting that in these cells the *trans*-flagellum was beating more rapidly or more effectively. Because the balance of beat of the two axonemes appears to be modulated by submicromolar levels of Ca^{++} , with $\leq 10^{-8}$ M Ca^{++} favoring the *cis*-flagellum and 10^{-7} – 10^{-6} M Ca^{++} favoring the *trans*-flagellum (37, and Hoops, H. J., and G. B. Witman, unpublished observations on *Chlorogonium*), these cells probably had a slightly higher concentration of intracellular Ca^{++} , resulting in dominance of the *trans*-flagellum. In at least one track, the eyespot was observed to shift from the outside of the helix to the inside (or vice versa); this probably reflected a shift in intracellular Ca^{++} concentration during the time that the track was recorded. (We know that intracellular Ca^{++} fluxes were induced under the conditions used to observe the eyespot, because many cells underwent the photophobic response when they entered the illuminated field of view, and a much larger increase in intracellular Ca^{++} is required to elicit the photophobic response than to change the balance of beating of the two axonemes [5, 34, 35, 37, 60]). Although definitive evidence must await unequivocal identification of the faster beating flagellum relative to the eyespot, our observations on nondividing and dividing *Chlorogonium* cells suggest that elements inherent in the axoneme and/or transition region determine the balance of beat between the two flagella.

The photoreceptor of chlorophycean cells is thought to be associated with one of the membranes overlying the eyespot (3, 21, 42, 44, 67); the latter structure presumably acts as a shading device (3, 41, 42, 67) or a light-reflecting antenna (21) to enable the organism to determine light direction. In those chlorophycean cells where it has been investigated, the eyespot is associated with one of the larger microtubular rootlets (41, 46). The possibility that this rootlet plays a direct

role in phototaxis by propagating a signal from the eyespot to the flagellar apparatus has been raised by previous investigators (41, 42, 46, 67). However, our finding that dividing cells of *Chlorogonium* manifest an apparently normal negative phototaxis clearly shows that the signal required for phototaxis can be transmitted to the flagella in the absence of the rootlet. Signal transduction probably occurs via the plasma membrane, as is the case in ciliates (15, 38). It should be noted that signal transmissions along cytoplasmic microtubules and microtubular rootlets have been postulated to occur in other types of cells (2, 4, 22), but nowhere is there convincing evidence for such a role for these structures. In *Chlorogonium* and *Chlamydomonas*, the microtubular rootlet may be important in proper positioning of the eyespot during the latter's morphogenesis (41, 42, and see below).

In dividing cells, the parental eyespot is not always present in the daughter cell containing the parental flagella. Nevertheless, dividing cells are as negatively phototactic as nondividing ones, suggesting that cells lacking a parental eyespot may be phototactic. There are several possibilities that could account for this: (a) The daughter cell containing the parental flagella may have a newly synthesized eyespot and photoreceptor that is properly positioned relative to the parental flagella to permit normal phototaxis. (b) The daughter cell receiving the parental flagella may remain electrically coupled to the daughter cell receiving the parental eyespot. (c) The eyespot, an intra-chloroplast structure in chlorophycean cells (21, 57), may separate from the photoreceptor, which is probably located in the plasma membrane (3, 21, 67). The photoreceptor alone could then be passed to the daughter cell receiving the parental flagella. Studies of a *Chlamydomonas* mutant that lacks the eyespot but apparently has the photoreceptor (47) indicate that such a cell could be phototactic, although its orientation to light would be less precise than in the presence of the eyespot. Further work will be necessary to determine whether one of these possibilities is actually the case.

It has been proposed that the fibers and rootlets associated with the basal body are responsible for anchoring the flagellum to the cell (2, 53, 54, 61, 65). In dividing cells of *Chlorogonium*, this function is probably taken over by the cross-striated filamentous component that extends from the transition region to the underlying apical mitochondrion. However, it is interesting that the basal bodies are lost from each axoneme, and the filamentous structures are assembled at the base of each axoneme, without loss of the flagella or change in the flagellar orientation as determined by the direction of the effective stroke. The mechanism by which this occurs is not yet known. There are fibers that connect the base of the axoneme to the flagellar membrane (reference 14 and Figs. 3-5), but it is not clear that the membrane is sufficiently rigid to hold the flagella to the cell and maintain the correct rotational orientation of the axonemes during assembly of the filamentous component.

Although the flagellar basal structures of *Chlorogonium* do not appear to be required for control of flagellar motion, they probably play a significant role in cellular morphogenesis in this alga.

First, in *Chlorogonium*, as in many related species (52), numerous phycoplast microtubules originate in the region around the basal bodies during cytokinesis, implying that this area is a microtubule organizing center and may determine the position and/or orientation of the cleavage furrow. The

basal bodies themselves are presumably not required to organize the phycoplast because other, related algae can organize this structure in the apparent absence of the basal bodies (see reference 52).

Second, the region of the cytoplasm containing the basal bodies after the final cytokinesis is destined to become the apex of each of the daughter cells, suggesting that the basal bodies or some component associated with them determines the anterior pole of the daughter cell. Indeed, the daughter cell which retains the parental flagella has a polarity opposite that of the parental cell, whereas daughter cells in the posterior of the parental cell have the same polarity as the parent. Because the basal body, distal striated fiber, and microtubular rootlets are synthesized very early in the cell cycle, these structures would be available as morphogenetic scaffolding upon which to build the rest of the cell. In the Chlorophyceae, both the eyespot and the mating structure are normally associated with particular types of rootlets, suggesting that their position is developmentally determined by the rootlets or associated structures (27, 42). The striated fibers of *Chlorogonium* and *Chlamydomonas* are in an ideal position to originate and maintain the basal body orientation such that the intrinsic flagellar polarity (32, 43) results in effective flagellar motion (32). A mutant of *Chlamydomonas* in which the striated fibers and microtubular rootlets are missing or abnormal has several morphogenetic anomalies, including abnormal positioning of cellular contents at cytokinesis, occasional displacements of the nucleus and pyrenoid, aberrant configuration of the basal body complex, and random rotational orientation of the flagella (33, 70). The microtubular rootlets of the naked chlorophyte *Polytomella* are microtubular organizing centers in vivo and in vitro (63, 64), and appear to have a role in determining the form of that alga (10). Taken together, these considerations strongly suggest that the structures associated with the base of the flagellar apparatus have important functions in cellular morphogenesis.

In most motile chlorophycean cells, basal bodies or centrioles are found lateral to the spindle pole during division (12, 19, 52, 66). In the naked chlorophyte *Asteromonas*, the absence of a cell wall permits the flagella to remain attached to the basal bodies as they move toward the spindle pole, and the organism remains motile throughout division (19). Such a strategy is not possible with walled organisms such as *Chlamydomonas* or *Chlorogonium*. Instead, the basal bodies (centrioles) must detach from the flagella if they are to migrate to the region of the nascent spindle pole (12, 36). *Chlamydomonas* (11, 40), like most other unicellular chlorophytes (23), resorbs its flagella before mitosis, freeing its basal bodies for their subsequent migrations. In contrast, the flagella of *Chlorogonium* and *Polytoma* detach from the basal bodies but remain functional. Presumably, different selective pressures have resulted in the evolution of these different strategies. In *Chlamydomonas*, resorption of the flagella may permit the organism to reutilize its flagellar proteins for the assembly of new flagella or other microtubular organelles (13). In *Chlorogonium* and *Polytoma*, there may be a greater advantage in remaining motile during division.

This work was supported by grants GM 08761, GM 30626, and CA 12708 from the National Institutes of Health.

Received for publication 18 June 1984, and in revised form 25 September 1984.

REFERENCES

1. Allen, C., and G. G. Borisy. 1974. Structural polarity and directional growth of microtubules of *Chlamydomonas* flagella. *J. Mol. Biol.* 90:381-402.
2. Allen, R. D. 1967. Fine structure, reconstruction and possible function of components of the cortex of *Tetrahymena pyriformis*. *J. Protozool.* 14:553-565.
3. Arnott, H. J., and R. M. Brown, Jr. 1967. Ultrastructure of the eyespot and its possible significance in phototaxis of *Tetracystis excentrica*. *J. Protozool.* 14:529-539.
4. Atena, J. 1973. Microtubule theory of sensory transduction. *J. Theor. Biol.* 38:181-190.
5. Bessen, M., R. B. Fay, and G. B. Witman. 1980. Calcium control of waveform in isolated axonemes of *Chlamydomonas*. *J. Cell Biol.* 86:446-455.
6. Bold, H. C., and M. T. Wynne. 1978. Introduction to the Algae. Structure and Reproduction. Prentice-Hall, Inc., Englewood Cliffs, New Jersey. 706 pp.
7. Boscov, J. S., and M. E. Feinleib. 1979. Phototactic response of *Chlamydomonas* to flashes of light. II. Response of individual cells. *Photochem. Photobiol.* 30:499-505.
8. Brokaw, C. J., and D. J. L. Luck. 1983. Bending patterns of *Chlamydomonas* flagella. I. Wild-type bending patterns. *Cell Motil.* 3:131-150.
9. Brokaw, C. J., D. J. L. Luck, and B. Huang. 1982. Analysis of the movement of *Chlamydomonas* flagella: the function of the radial-spoke system is revealed by comparison of wild-type and mutant flagella. *J. Cell Biol.* 92:722-733.
10. Brown, D. L., A. Massalski, and R. Patenaude. 1976. Organization of the flagellar apparatus and associated cytoplasmic microtubules in the quadriflagellate alga *Polytomella agilis*. *J. Cell Biol.* 69:106-125.
11. Cavalier-Smith, T. 1974. Basal body and flagellar development during the vegetative cell cycle and the sexual cycle of *Chlamydomonas reinhardtii*. *J. Cell. Sci.* 16:529-556.
12. Coss, R. A. 1974. Mitosis in *Chlamydomonas reinhardtii*: basal bodies and the mitotic apparatus. *J. Cell Biol.* 63:325-329.
13. Coyne, B., and J. L. Rosenbaum. 1970. Flagellar elongation and shortening in *Chlamydomonas* II. Re-utilization of flagellar proteins. *J. Cell Biol.* 47:777-781.
14. Dentler, W. L. 1981. Microtubule-membrane interactions in cilia and flagella. *Int. Rev. Cytol.* 72:1-47.
15. Eckert, R., and P. Brehm. 1979. Ionic mechanisms of excitation in *Paramecium*. *Annu. Rev. Biophys. Bioeng.* 8:353-383.
16. Fawcett, D. W. 1970. A comparative view of sperm ultrastructure. *Biol. Reprod.* 2(Suppl. 2):90-127.
17. Fawcett, D. W., and D. M. Phillips. 1969. The fine structure and development of the neck region of the mammalian spermatozoon. *Anat. Rec.* 165:153-184.
18. Flagellar movement in *Chlamydomonas* [Motion picture]. Encyclopedia Cinematographica Japan Archives and Tokyo Cinema Inc. Tokyo; 1978. 16 mm. 5 min, 30 s. Color.
19. Floyd, G. L. 1978. Mitosis and cytokinesis in *Asteromonas gracilis*, a wall-less, green monad. *J. Phycol.* 14:440-445.
20. Floyd, G. L., H. J. Hoops, and J. A. Swanson. 1980. Fine structure of the zoospore of *Ulothrix belkae* with emphasis on the flagellar apparatus. *Protoplasma.* 104:17-31.
21. Foster, K. W., and R. D. Smyth. 1980. Light antennas in phototactic algae. *Microbiol. Rev.* 44:572-630.
22. Friedmann, I., A. L. Colwin, and L. H. Colwin. 1968. Fine-structural aspects of fertilization in *Chlamydomonas reinhardtii*. *J. Cell Sci.* 3:115-128.
23. Fritsch, F. E. 1935. The Structure and Reproduction of the Algae. Vol. 1. Cambridge University Press, Cambridge, 791 pp.
24. Fulton, C., and A. D. Dingle. 1971. Basal bodies, but not centrioles in *Naegleria*. *J. Cell Biol.* 51:826-836.
25. Gaffal, K. P. 1977. The relationship between basal bodies and the motility of *Polytoma papillatum* flagella. *Experientia.* 33:1372-1374.
26. Gaffal, K. P., and G. J. Schneider. 1980. Morphogenesis of the plastidome and the flagellar apparatus during the vegetative life cycle of the colourless phytoflagellate *Polytoma papillatum*. *Cytobios.* 27:43-61.
27. Goodenough, U. W., and R. L. Weiss. 1978. Interrelationships between microtubules, a striated fiber, and the gametic mating structure of *Chlamydomonas reinhardtii*. *J. Cell Biol.* 76:430-438.
28. Gordon, M. 1972. The distal centriole in guinea pig spermiogenesis. *J. Ultrastruct. Res.* 39:364-388.
29. Gould, R. R. 1975. The basal bodies of *Chlamydomonas reinhardtii*. Formation from probasal bodies, isolation, and partial characterization. *J. Cell Biol.* 65:65-74.
30. Hartmann, M. 1919. Untersuchungen über die Morphologie und Physiologie des Formwechsels (Entwicklung, Fortpflanzung, Befruchtung und Vererbung) der Phytonadinen (Volvocales). Programm der Untersuchungen und I. Mitt.: über die Kern und Zellteilung von *Chlorogonium elongatum* Dangeard. *Arch. f. Protistenkunde* 39:1-33.
31. Hepler, P. K. 1976. The blepharoplast of *Marsilea*: its *de novo* formation and spindle association. *J. Cell Sci.* 21:361-390.
32. Hoops, H. J., and G. B. Witman. 1983. Outer doublet heterogeneity reveals structural polarity related to beat direction in *Chlamydomonas* flagella. *J. Cell Biol.* 97:902-908.
33. Hoops, H. J., R. L. Wright, J. W. Jarvik, and G. B. Witman. 1984. Flagellar waveform and rotational orientation in a *Chlamydomonas* mutant lacking normal striated fibers. *J. Cell Biol.* 98:818-824.
34. Hyams, J. S., and G. G. Borisy. 1975. Flagellar coordination in *Chlamydomonas reinhardtii*: Isolation and reactivation of the flagellar apparatus. *Science (Wash. DC)*. 189:891-893.
35. Hyams, J. S., and G. G. Borisy. 1978. Isolated flagellar apparatus of *Chlamydomonas*: characterization of forward swimming and alteration of waveform and reversal of motion by calcium ions *in vitro*. *J. Cell Sci.* 33:235-253.
36. Johnson, U. G., and K. K. Porter. 1968. Fine structure of cell division in *Chlamydomonas reinhardtii*. Basal bodies and microtubules. *J. Cell Biol.* 38:403-425.
37. Kamiya, R., and G. B. Witman. 1984. Submicromolar levels of calcium control the balance of beating between the two flagella in demembrated models of *Chlamydomonas*. *J. Cell Biol.* 98:97-107.
38. Kung, C., and Y. Saimi. 1982. The physiological basis of taxes in *Paramecium*. *Annu. Rev. Physiol.* 44:519-534.
39. Lembi, C. A. 1975. The fine structure of the flagellar apparatus of *Carteria*. *J. Phycol.* 11:1-9.
40. Lewin, R. A. 1952. Studies on the flagella of algae. I. General observations on *Chlamydomonas moewusii* Gerloff. *Biol. Bull.* 103:74-79.
41. Melkonian, M. 1978. Structure and significance of cruciate flagellar root systems in green algae: comparative investigations in species of *Chlorosarcinopsis* (Chlorosarcinales). *Plant Syst. Evol.* 130:265-292.
42. Melkonian, M. 1982. The functional analysis of the flagellar apparatus in green algae. In Prokaryotic and Eukaryotic Flagella. W. B. Amos and J. D. Duckett, editors. Cambridge University Press, Cambridge. 589-606.
43. Melkonian, M. 1984. Flagellar apparatus ultrastructure in relation to green algal classification. In The Systematics of the Green Algae. D. E. G. Irvine and D. M. John, editors. Academic Press, London. In press.
44. Melkonian, M., and H. Robenek. 1980. Eyespot membranes of *Chlamydomonas reinhardtii*: a freeze-fracture study. *J. Ultrastruct. Res.* 72:92-102.
45. Melkonian, M., and H. Robenek. 1980. Eyespot membranes in newly released zoospores of the green alga *Chlorosarcinopsis gelatinosa* (Chlorosarcinales) and their fate during zoospore settlement. *Protoplasma.* 104:129-140.
46. Moestrup, Ø. 1978. On the phylogenetic validity of the flagellar apparatus in green algae and other chlorophyll a and b containing plants. *BioSystems.* 10:117-144.
47. Morel-Laurens, N. M. L., and M. E. Feinleib. 1983. Photomovement in an "eyeless" mutant of *Chlamydomonas*. *Photochem. Photobiol.* 37:189-194.
48. Paolillo, D. J. 1975. Motile male gametes in plants. In Dynamic Aspects of Plant Ultrastructure. A. W. Robards, editor. McGraw-Hill, London. 504-531.
49. Phillips, D. M. 1970. Insect sperm: their structure and morphogenesis. *J. Cell Biol.* 44:243-277.
50. Phillips, D. M. 1974. Structural variants in invertebrate sperm flagella and their relationship to motility. In Cilia and Flagella. M. A. Sleight, editor. Academic Press, London. 379-402.
51. Pickett-Heaps, J. D. 1968. Ultrastructure and differentiation in *Chara (fibrosa)*. IV. Spermatogenesis. *Aust. J. Biol. Sci.* 21:655-690.
52. Pickett-Heaps, J. D. 1975. Green Algae: Structure, Reproduction and Evolution in Selected Genera. Sinauer Associates, Sunderland, Massachusetts. 606 pp.
53. Pitelka, D. R. 1969. Fibrillar systems in protozoa. In Research in Protozoology. Vol. 3. T. T. Chen, editor. Pergamon Press, Oxford. 280-388.
54. Pitelka, D. R. 1974. Basal bodies and root structures. In Cilia and Flagella. M. A. Sleight, editor. Academic Press, London. 437-469.
55. Ringo, D. L. 1967. Flagellar motion and fine structure of the flagellar apparatus of *Chlamydomonas*. *J. Cell Biol.* 33:543-571.
56. Sager, R., and S. Granick. 1953. Nutritional studies with *Chlamydomonas reinhardtii*. *Ann. NY Acad. Sci.* 56:831-838.
57. Sager, R., and G. E. Palade. 1957. Structure and development of the chloroplast in *Chlamydomonas*. I. The normal green cell. *J. Biochem. Biophys. Cytol.* 3:463-488.
58. Salisbury, J. L., and G. L. Floyd. 1978. Calcium-induced contraction of the rhizoplast of a quadriflagellate green alga. *Science (Wash. DC)*. 202:975-977.
59. Salisbury, J. L., J. A. Swanson, G. L. Floyd, R. Hall, and N. Maihle. 1981. Ultrastructure of the flagellar apparatus of the green alga *Trisetoselmis subcordiformis*, with special consideration given to the function of the rhizoplast and rhizanchora. *Protoplasma.* 107:1-11.
60. Schmidt, J. A., and R. Eckert. 1976. Calcium couples flagellar reversal to photostimulation in *Chlamydomonas reinhardtii*. *Nature (Lond.)* 262:713-715.
61. Sleight, M. A., and N. R. Silvester. 1983. Anchorage functions of the basal apparatus of cilia. *J. Submicrosc. Cytol.* 15:101-104.
62. Starr, R. C. 1978. The culture collection at the University of Texas at Austin. *J. Phycol.* 14 (suppl.):47-100.
63. Stearns, M. E., and D. L. Brown. 1981. Microtubule organizing centers (MTOCs) of the alga *Polytomella* exert spatial control of microtubule initiation *in vitro*. *J. Ultrastruct. Res.* 77:366-378.
64. Sterns, M. E., J. A. Connolly, and D. L. Brown. 1976. Cytoplasmic microtubule organizing centers isolated from *Polytomella agilis*. *Science (Wash. DC)*. 191:188-191.
65. Stephens, R. E. 1975. The basal apparatus: mass isolation from the molluscan ciliated gill epithelium and a preliminary characterization of striated rootlets. *J. Cell Biol.* 64:408-420.
66. Triemer, R. E., and R. M. Brown, Jr. 1974. Cell division in *Chlamydomonas moewusii*. *J. Phycol.* 10:419-433.
67. Walne, P. A., and H. J. Arnott. 1967. The comparative ultrastructure and possible function of eyespots: *Euglena granulata* and *Chlamydomonas eugametos*. *Planta (Berl.)*. 77:325-353.
68. White, R. B., and D. L. Brown. 1981. ATPase activities associated with the flagellar apparatus of *Polytomella*. *J. Ultrastruct. Res.* 75:151-161.
69. Wooley, D. M., and D. W. Fawcett. 1973. The degeneration and disappearance of the centrioles during the development of the rat spermatozoon. *Anat. Rec.* 177:289-302.
70. Wright, R. L., B. Chojnacki, and J. W. Jarvik. 1983. Abnormal basal body number, location and orientation in a striated fiber defective mutant of *Chlamydomonas reinhardtii*. *J. Cell Biol.* 96:1697-1707.