

Determination of Cell Division Axes in the Early Embryogenesis of *Caenorhabditis elegans*

Anthony A. Hyman and John G. White

Medical Research Council, Laboratory of Molecular Biology, Cambridge CB2 2QH, England

Abstract. The establishment of cell division axes was examined in the early embryonic divisions of *Caenorhabditis elegans*. It has been shown previously that there are two different patterns of cleavage during early embryogenesis. In one set of cells, which undergo predominantly determinative divisions, the division axes are established successively in the same orientation, while division axes in the other set, which divide mainly proliferatively, have an orthogonal pattern of division. We have investigated the establishment of these axes by following the movement of the centrosomes. Centrosome separation follows a reproducible pattern in all cells, and this pattern by itself

results in an orthogonal pattern of cleavage. In those cells that divide on the same axis, there is an additional directed rotation of pairs of centrosomes together with the nucleus through well-defined angles. Intact microtubules are required for rotation; rotation is prevented by inhibitors of polymerization and depolymerization of microtubules. We have examined the distribution of microtubules in fixed embryos during rotation. From these and other data we infer that microtubules running from the centrosome to the cortex have a central role in aligning the centrosome-nuclear complex.

THE embryos of many invertebrates exhibit a stereotypic pattern of division during early embryogenesis. These divisions can involve the segregation of specific cytoplasmic components, some of which may be involved in determining the differentiated state of early blastomeres (see Davidson, 1976). In many embryos there is a link between the division pattern and the distribution of these components into daughter cells (see Wilson, 1925; Freeman, 1983; Strome and Wood, 1983). The pattern of cleavage depends upon the mechanisms determining the position of the mitotic apparatus since the cleavage furrow always forms at right angles to the axis of the mitotic apparatus (reviewed by Conrad and Rappaport, 1981). A mitotic apparatus has a centrosome at each pole which acts as a microtubule organizing center (Gould and Borisy, 1977). A cell inherits a centrosome, which duplicates, and establishes the two poles of the mitotic spindle by the separation and migration of the daughter centrosomes. A mitotic spindle forms between the poles (see Karsenti and Maro, 1986). Thus the positions in which the centrosomes are placed will ultimately define the position of the division axis. However, the relative role of centrosomes, chromosomes, and other unknown factors in actually organizing the bipolar spindle is unclear and remains an active area of research. (Mazia et al., 1981; Nicklas and Gordon, 1985; Sluder et al., 1982).

In this paper we have analyzed the movement of the centrosomes in the early embryonic divisions of *Caenorhabditis elegans* in order to ask how the division axes are established. In the early embryos of *C. elegans* two well-defined patterns of division can be distinguished (Nigon et al., 1960; Sulston

et al., 1983). In one set of blastomeres, the division axes are established successively on the same axis. These blastomeres divide unequally and sister blastomeres have different developmental potentials (Laufer et al., 1980; Strome and Wood, 1983; Sulston et al., 1983). Division axes in the other set are established in an orthogonal pattern (Laufer et al., 1980). These divisions appear equal; sister blastomeres have equivalent development potentials (Priess and Thomson, 1987). We have investigated the patterns of centrosome movement involved in generating these two different patterns of division.

Materials and Methods

Nematode Strains and Maintenance

Wild type (N2) *Caenorhabditis elegans* (strain Bristol) was cultured at 20°C on agar plates with *Escherichia coli* strain OP50 as a food source (Brenner, 1974).

Culture Media and Inhibitor Solutions

The embryonic culture medium used in all experiments consisted of 4% sucrose and 0.1 M NaCl. The osmolarity of the culture medium is critical, and is tested by determining whether the embryo swells or shrinks after laser permeabilization of the eggshell. The stock solutions consisted of the following. Cytochalasin D, 1 mg/ml in DMSO for experiments using 5 µg/ml; 10 mg/ml in ETOH for experiments involving 40 µg/ml. Colcemid (Sigma Chemical Co., Poole, England), 1 mg/ml in water. Nocodazole, 5 mg/ml in DMSO. Taxol (a gift from National Institutes of Health, Bethesda, MD) 10 mM in DMSO. Inhibitors were stored cold and added to the embryonic culture medium immediately before use.

Examination of Embryos

Embryos were examined by light microscopy using Nomarski differential interference contrast microscopy (Sulston and Horvitz, 1977). Embryos were placed on a thin pad of 2% agarose and covered with a coverslip and sealed with vaseline. Development was recorded using a Hamamatsu video camera together with an RCA Corp. time-lapse video recorder.

Laser Permeabilization of Embryos

Embryos were cut from gravid hermaphrodites, and collected with a micropipette and clustered on a thin pad of 2% agarose following the general procedure of Sulston et al. (1983). A coverslip coated with 0.1% polylysine was placed on top of the embryos, then lifted gently from the pad with the attached embryos by flooding the pad with a drop of water. The coverslip was inverted and the embryos covered with a drop of polylysine for 30 s. Excess polylysine was removed, and a drop of 1 mg/ml trypan blue was added for 1 min. The trypan blue was removed, and the embryos were then rinsed in embryonic culture medium, and inverted over a depression slide containing the required medium. Embryos were examined by Nomarski, and a laser microbeam (Sulston and White, 1980) was used to irradiate selected embryos. The trypan blue bound to the eggshell allows permeabilization of the

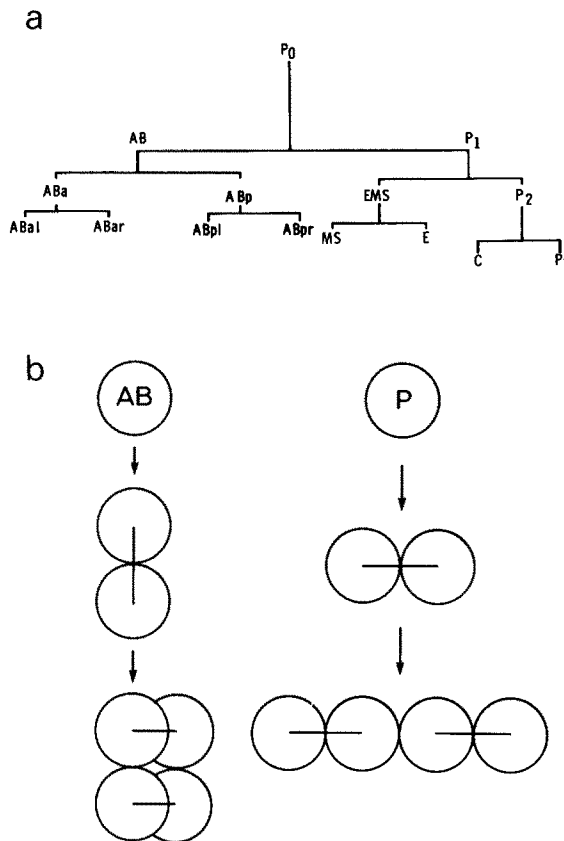

Figure 1. (a) The early lineage of the *C. elegans* embryo. P₀, P₁, P₂, and P₃ are germline precursor cells. The division of each of these precursors generates a founder cell and another germline precursor. The divisions of the P cells are determinative. They are unequal, and have been shown to involve the segregation of a cytoplasmic component, the P granules (Strome and Wood, 1983). The divisions of AB and its early descendants are probably proliferative. The divisions are synchronous and equal, and sister AB blastomeres are equally developmentally determined (Priess and Thomson, 1987). (b) The division patterns of the early embryonic divisions of *C. elegans*. The AB lineage divides with an orthogonal pattern such that successive AB divisions occur at 90° angles to the previous division. The P descendants successively divide on the same axis.

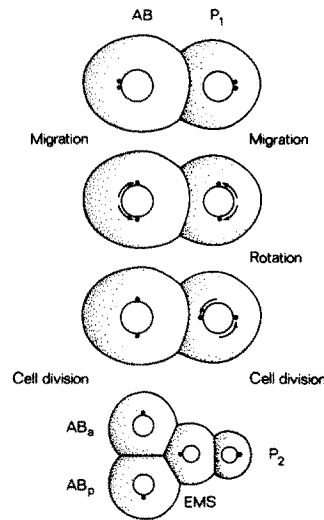

Figure 2. Diagram of the centrosome movements at the two-cell stage. The black dots represent the centrosomes and the arrows their direction of movement. This diagram does not represent the exact paths of movement of the centrosomes (see Fig. 4). Anterior is left; posterior is right. (Top) AB and P₁ have inherited one centrosome each, which has divided. (Upper middle) The centrosomes in AB and P₁ are migrating apart from one another. The paths of the centrosomes in either blastomere are reproducible and opposite. (Lower middle) The centrosomes in AB stay on the trans-

verse axis. The centrosomes of P₁ have rotated through 90°. (Bottom) If the constraints of the eggshell are removed, AB and P₁ divide to take up a 'T' configuration as shown in the bottom panel. In normal development the ellipsoid eggshell causes the embryo to skew around producing a tetrahedral configuration.

eggshell with the microbeam, by specifically increasing the absorption by the eggshell of the laser beam. Permeabilization of the eggshell allowed the drugs into the embryos.

Removal of the Eggshell

Early embryos were isolated by dissolving young adults with 1% hypochlorite, 0.5% KOH for 7 min. The embryos were rinsed twice in M9 buffer, with gentle spinning. Embryos were digested with chitinase using the procedure of Wolf et al. (1983). These embryos are not permeable to drugs. The inner layer of the eggshell was removed mechanically using a drawn out Pasteur pipette, after which the embryos were permeable (Priess and Hirsh, 1986). After removal of the eggshell, embryos are sensitive to pressure. These embryos were placed on a coverslip and mounted on an inverted microscope. The embryos were observed with a video camera using a 40× plan neofluar lens. This system does not give optimal results, but allows a significant fraction of the embryos to survive during observation.

Immunofluorescence Microscopy

In experiments with the anti-tubulin antibody YL 1/2 (Kilmartin et al., 1982), embryos were prepared for fixation according to Albertson (1984). Synchronous populations of worms were grown and harvested when the worms had two or three eggs inside them. Embryos were isolated by hypochloriting the worms and collecting the embryos by gentle centrifugation. The embryos were washed twice and placed on slides coated with 0.1% polylysine. A 12 × 12 coverslip was placed on top of the embryos such that they were gently squashed. The embryos were frozen by placing on dry ice for at least 10 min. The coverslip was snapped off and the slides immersed in methanol for 4 min and acetone for 4 min, and taken through an acetone series. The slides were washed for 20 min in TBS (150 mM NaCl, 20 mM Tris HCl, pH 7.4) containing 0.5% Tween 20. The slides were then incubated for 1 h in YL 1/2 at 37°C, washed in TBS-Tween 20 and incubated in FITC-conjugated anti-rat IgG (Sigma Chemical Co.), which had been affinity purified, for 1 h, and washed again. If desired, the slides were incubated with Hoechst 33258 (0.1 μg/ml; Hoechst Ltd., Middlesex, England) in TBS-Tween for 5 min, and rinsed in TBS-Tween for 5 min before mounting. Specimens were observed with a Zeiss RA microscope equipped with epifluorescence, or a confocal laser scanning microscope as described by White et al. (1987).

Embryos were stained with YL 1/2 after drug treatment as follows. Selected embryos were placed on a polylysine-coated slide in the presence of the inhibitor. An 18 × 18 coverslip was supported away from the embryos using teflon washers. Embryos were then permeabilized, allowing the drug to enter. At the required time the coverslip and washers were removed, and a 12 × 12 coverslip was placed on the embryos to gently squash them. The

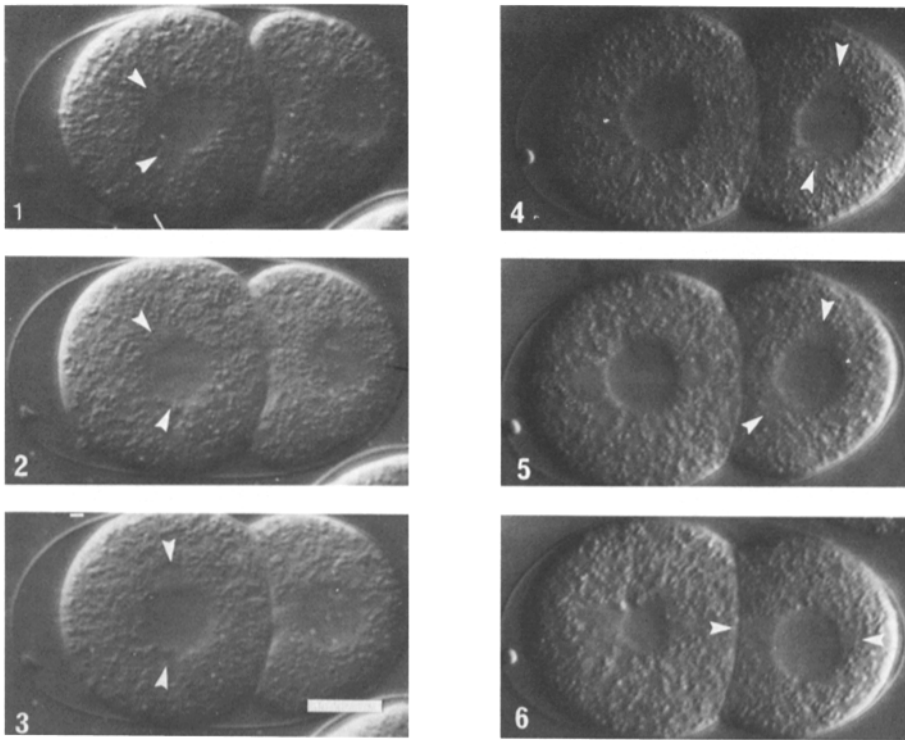

Figure 3. The centrosome movements at the two-cell stage shown by Nomarski microscopy. The centrosomes are seen by astral exclusion of yolk granules and are shown by white arrowheads. (Panels 1–3) The migration of the centrosomes in AB. (Panels 4–6) The rotation of the centrosomes in P₁. This embryo illustrates that the centrosomes do not always stay diametrically opposed on the nucleus (panels 4 and 5). One centrosome moves around the nucleus toward the anterior pole. In some cases, both centrosomes initially slip around towards the anterior pole. In general the centrosomes remain diametrically opposed on the nucleus during rotation, such that a straight line through the centrosomes passes through the center of the nucleus. (Panel 6) The centrosome–nuclear complex moves onto the longitudinal axis of the embryo. Bar, 10 μ m.

embryos were then frozen, and processed for immunofluorescence as described above.

Results

Development of Embryos

To clarify the observations in this paper, we describe briefly the development of early *C. elegans* embryos.

The first division spindle in the zygote, P₀, is set up along the anterior–posterior axis and generates the daughters AB and P₁ (Fig. 1). (The anterior–posterior axis is set up along the length of the ellipsoid eggshell with the polar body at the anterior end.) Subsequent divisions of the AB and P descendants reveal two patterns of division. The AB descendants have an orthogonal series of divisions, whereas the P descendants all divide on the same axis (Fig. 1) (Laufer et al., 1980). Thus the spindle in AB is set up transverse to the anterior–posterior axis and divides to give the daughters ABa and ABp (Fig. 1). ABa and ABp divide with a transverse axis, but orthogonally with respect to their parents. On the other hand, P₁ and most of its immediate progeny divide in the same orientation with their spindles aligned along the anterior–posterior axis of the cell. Thus, P₀, P₁, EMS, E, MS, and C (Fig. 1) all appear to divide anterior–posterior (Laufer et al., 1980). P₂ divides transversely and is an apparent exception to this scheme. However, blastomere isolation experiments have demonstrated that P₂ will divide on the anterior–posterior axis if the constraints of the eggshell are removed (Laufer et al., 1980).

There Is a Defined Pattern of Centrosome Movement in the Early Embryo

A description of the movement of the centrosomes in the

cells of the early embryos has been obtained by observations in living cells with Nomarski microscopy (Fig. 2 and Fig. 3). Centrosomes can be seen as areas devoid of yolk granules next to the nucleus. A further indication of centrosome position is given by vesicle movement towards the centrosome. The paths of centrosome movement have been reconstructed by examination of fixed specimens at different stages with anti-tubulin antibody (Kilmartin et al., 1982), revealing the centrosomes as foci of microtubules (Figs. 8 and 9).

Centrosome Movements in AB Blastomeres

After division of P₀, AB inherits one centrosome, and the nucleus forms between this centrosome and the site of the P₀ cleavage furrow. The AB centrosome stays visible by Nomarski microscopy throughout interphase. About 7 min after telophase of P₀ this centrosome divides, and the daughter centrosomes migrate apart from one another on the surface of the nucleus until diametrically opposed on a transverse axis (Fig. 2 and Fig. 3, panels 1–3). The movements of the AB centrosomes have been followed in real time by video microscopy (Fig. 4). This shows that the migration of the centrosomes occurs over the surface of the nucleus. Each centrosome migrates an equal distance from the original site of the centrosome in AB and therefore the centrosome movements are equal and opposite. After division of AB and the formation of the midbody, the centrosomes are in reproducible positions in ABa and ABp where they split and migrate to form an axis orthogonal to the spindle axis of AB (Fig. 5). We conclude that the early AB blastomeres divide on orthogonal axes because of the orthogonal migration pattern of the centrosomes. A feature of the centrosome migrations in AB descendants is that although there are an infinite number of axes that centrosomes could establish on the orthogonal plane, they always migrate onto a particular orthogonal axis

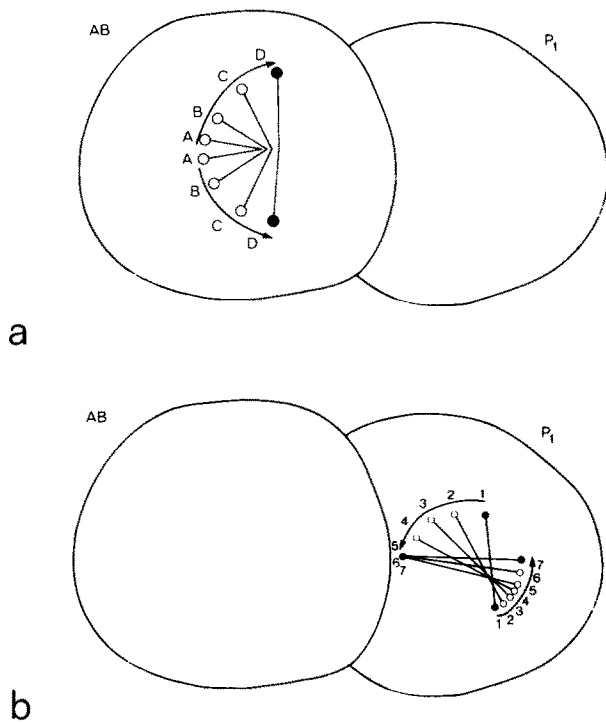

Figure 4. The centrosome movements at the two-cell stage, traced from a video screen. The AB and P₁ centrosomes were traced from different embryos, and an essentially similar pattern has been seen in 14 different embryos. (a) The circles represent the middle of the centrosome and the lines represent the distance to the middle of the nucleus. In A, the centrosomes have divided. This represents the first time that the centrosomes can be seen as separate entities, ~7 min after telophase of P₀. The time points B, C, and D in AB are taken at 1-min intervals. The tracing shows that the paths of centrosome movement are equal and opposite with respect to the nucleus. In D, the solid circles represent the final positions of migration. Note that during the migration, the nucleus moves slightly posterior. Centrosome–nuclear movements in P₁ during rotation. (b) Circles 1–7 represent time points taken at 10-s intervals. The line connecting two circles represents the diameter of the nucleus. The two solid circles at position 1 represent the positions of the centrosomes after migration in P₁ (paths are not shown in this figure). In the first 40 s (positions 1–5), one centrosome moves through 10 μm to the anterior cortex. In the same period, the posterior centrosome moves through 3.5 μm. After the anterior centrosome has reached the anterior cortex (position 5), the posterior centrosome moves onto the longitudinal axis (positions 6 and 7). This usually requires 20 s. The total time for rotation is ~1 min.

(see Fig. 5). Thus, the centrosomes in ABa might in principle migrate onto the future left–right or dorsal–ventral axes, but in practice migrate onto the future left–right axis.

Centrosome Movements in P Blastomeres

In contrast to the AB blastomeres, the blastomeres P₀, P₁, P₂, EMS, and E (Fig. 1) divide successively on the anterior–posterior axis (Laufer et al., 1980). Analysis of the paths of centrosome movement shows that initially the migration of the centrosomes proceeds as described above for the AB blastomeres. After this orthogonal migration is completed, there is a rotation of the centrosomes and nucleus through 90° (Fig. 2 and Fig. 3, panels 4–6). This rotation is similar to that previously described for the rotation of

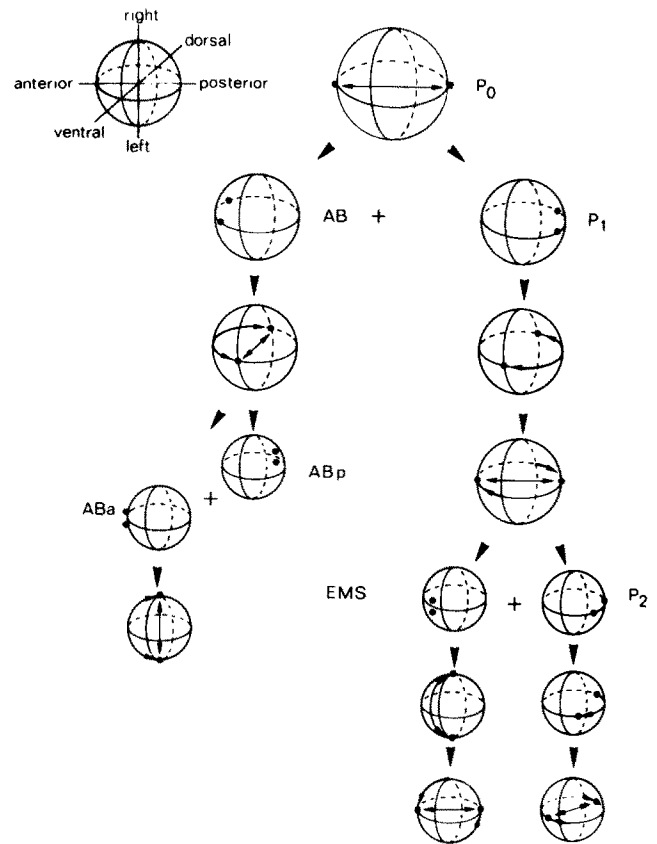

Figure 5. Diagram of the movement of the centrosomes in the early AB and P divisions. The associated diagram shows the axes of the embryo. The spheres represent the nuclei, the black dots are the centrosomes, and the arrows represent their movements. The double arrow inside the spheres represents the axis of division. P₀ divides on an anterior–posterior axis to give P₁ and AB. The AB lineage will be described first. AB inherits one centrosome and this divides. The centrosomes migrate apart onto a transverse axis. This is the division axis of AB, and AB divides to give ABa and ABp. Although AB is a transverse division, during division the AB daughters get pushed diagonally by the constraints of the eggshell, and are thus named ABa and ABp. (The division of AB establishes the dorsal–ventral axis of the embryo.) The midbody in ABa and ABp gets pushed by the advancing cleavage furrow so that the centrosomes become displaced off the axis expected by the initial spindle position (Schnabel, R., personal communication); the centrosomes are positioned as shown. The centrosome movements in ABa are illustrated. The centrosomes migrate onto the future left–right axis, the division axis of ABa. Thus, the AB centrosomes have migrated on defined orthogonal axes in successive divisions, and the AB division axes are defined by this pattern of migration. P₁ has inherited one centrosome from P₀. This divides, and the centrosomes migrate apart on a transverse axis, as in AB. (The figure has been stylized because in general the AB and P₁ centrosomes migrate on transverse axes that are random with respect to one another.) The P₁ centrosome–nuclear complex rotates onto the anterior–posterior axis, the axis on which P₁ divides. P₁ divides to give the daughters P₂ and EMS. The centrosome movements of EMS and P₂ are illustrated. The centrosomes of EMS migrate onto the left–right axis, and then rotate onto the anterior–posterior axis. The centrosomes of P₂ migrate onto the dorsal–ventral axis. Before they finish migrating, they rotate through 45°: this rotation puts the centrosomes onto the anteriordorsal–posteroventral axis. The centrosome–nuclear complex of P₂ subsequently gets pushed onto the dorsal–ventral axis of the embryo by the anaphase B movements of EMS.

the centrosomes and pronuclei in P_0 (Albertson, 1984). After the pronuclei meet, the centrosomes lie on an orthogonal axis. The centrosomes and pronuclei then rotate onto the anterior–posterior axis of the embryo, the division axis of P_0 .

To examine the rotation in detail, the movements of P_1 were recorded with time-lapse video microscopy, and traced from the screen (Fig. 4). Examination of features visible by Nomarski microscopy on the surface of the nucleus during rotation indicated that the centrosomes and nucleus move as a coordinated complex, with the centrosomes staying diametrically opposed with fixed positions on the nucleus. Measurements taken from 10 embryos have given an average time for rotation of 1 min (SD = 10 s). The movements of the centrosomes were plotted at 10-s intervals in order to reconstruct the exact path of movement during the rotation. The paths taken in a typical rotation are illustrated in Fig. 4. In P_1 the initial movement takes ~ 40 s. The more anterior centrosome moves through a larger arc than the posterior centrosome (Fig. 4), such that the anterior centrosome comes closely apposed to the anterior cortex of the cell. The arc traced by the posterior centrosome whilst the anterior centrosome is moving can vary, and in 30% of embryos examined, the initial movement involves pivoting of the centrosome–nuclear complex about the posterior centrosome. In the subsequent 20 s the posterior centrosome moves onto the longitudinal axis of the cell. This suggests that the rotation may be brought about by the pulling of one centrosome toward the anterior cortex. Other suggestive evidence for this idea was that in $\sim 5\%$ of embryos examined, the centrosomes do not move coordinately (Fig. 3). In these embryos, one or both of the centrosomes slip around the nucleus toward the anterior of the cell during rotation after migration. Then, one centrosome seems to win out and contacts the anterior cortex, whilst the other moves posteriorly onto the longitudinal axis.

We wanted to examine whether the direction of rotation was random. At the one- and two-cell stage of embryogenesis, only the longitudinal axis of the embryo has been defined. To determine the direction of rotation in P_1 , the direction of the rotation was recorded with respect to the axes that were subsequently set up in the embryo. Of 11 P_1 blastomeres analyzed, five rotations were clockwise and six were anticlockwise (see Fig. 6). The rotation of the centrosome–nuclear complex was further examined at the four-cell stage, by which time the dorsal–ventral axis has been established. We have analyzed seven cases of rotation in EMS, in which four cases rotated clockwise whereas the other six cases were in the anticlockwise direction. The direction of rotation therefore appears random with respect to the body axes in both P_1 and EMS.

We investigated the time in the cell cycle at which rotation occurs by double labeling with Hoechst 33258 (Hoechst Ltd.) and an anti-tubulin antibody (Kilmartin et al., 1982). Thus the state of chromatin condensation could be determined relative to the position of the centrosomes. Rotation occurs towards the end of prophase, when the condensing chromosomes were easily visualized by Hoechst staining but the nuclear envelope had not broken down (data not shown).

The movement of the centrosomes in P_2 differs from that seen in the other P blastomeres. The centrosomes initially migrate apart from one another, but before they lie diametri-

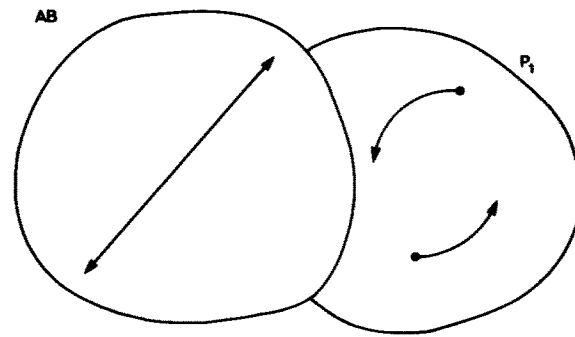

Figure 6. Determination of the direction of rotation in P_1 . The dorsal–ventral axis at the two cell stage is determined by the positioning of the spindle during anaphase B of AB. This positioning is due to the constraints of the eggshell. The AB spindle elongates and then skews around onto a diagonal. This is illustrated by the direction of the arrow in AB in the diagram. The skewing pushes the P_1 spindle such that the four-cell embryo is a tetrahedron (see Priess and Thomson, 1987). The four-cell embryo is always represented with dorsal up and anterior to left. The direction of rotation in P_1 was followed and then the embryo was allowed to divide into four cells. The direction of the dorsal–ventral axis was recorded. The direction of rotation was then normalized so that dorsal was up. In the embryo illustrated, the direction was anticlockwise.

cally opposite one another they rotate by 45° towards the EMS– P_2 boundary (Fig. 9, panels 8 and 9). Thus, in the case of P_2 , the rotation occurs during migration, and, in contrast to other rotations, is only through 45° .

Rotation Brings the Centrosomes onto a Predetermined Axis

We wanted to know whether rotation established the division axis of the embryo, or whether the centrosomes were moving onto a predetermined axis. In P_0 and P_1 , P granules segregate along the longitudinal axis of the cell before division (Strome and Wood, 1983). These blastomeres have a longitudinal axis of division which is defined by the rotation of the centrosome–nuclear complex. Since both P granule segregation and centrosomal alignment occur on the same axis, we investigated the temporal relationship of P-granule segregation and rotation. Double staining of two- and four-cell embryos with an anti-tubulin antibody and an anti-P-granule antibody showed that the rotation occurred after P-granule segregation in P_1 and P_2 (data not shown), as had previously been shown to be the case in P_0 (Strome and Wood, 1983). In P_2 , P granules segregate at 45° to the transverse axis (Strome and Wood, 1982). As described above, the centrosomes also rotate through 45° in P_2 (Fig. 9, panels 8 and 9). Again, the movement of the centrosome–nuclear complex after centrosome separation aligns the division axis along the axis of P-granule movement. Thus, the rotation in P_0 , P_1 , and P_2 aligns the centrosomes on a previously determined axis.

To determine whether the localization of the P granules and the rotation of the centrosomes are dependent on each other, we examined the embryonic lethal mutant *par-1* (b 274). This mutant is deficient in many early asymmetric events: the cell cycle times of the early blastomeres are equal, and there is no segregation of P granules. Instead of segregating to the posterior of P_0 before division, the P granules remain dis-

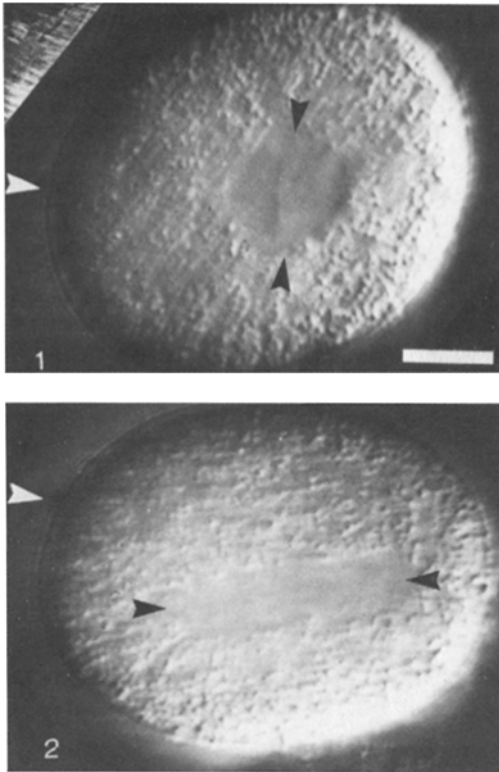

Figure 7. Rotation in spherical P_0 . Spherical P_0 embryos were obtained by proteolytic digestion of the ellipsoid eggshell. The white arrows mark the position of the polar body, which defines the anterior pole (Albertson, 1984). The black arrows mark the position of the centrosomes. (Panel 1) The centrosomes are lying in a transverse orientation. (Panel 2) After 2 min, the centrosomes have rotated onto the longitudinal axis. In panel 2 the embryo has become elongated presumably by the establishment of the mitotic spindle. Bar, 10 μm .

tributed over the whole cytoplasm. After division of P_0 , the P granules are inherited by both daughters. (Priess, J., personal communication). Although the P granules do not segregate in this mutant, we have shown that rotation of the centrosome-nuclear complex still occurs in P_0 and P_1 (data not shown). This may indicate that rotation and P granule segregation are independent events.

Longitudinal Axis Is Not Defined by the Shape of the Egg

Rotation in P_0 occurs in an ellipsoid eggshell, and the longitudinal axis of the egg corresponds to the long axis of the ellipse. It has been suggested that the rotation in P_0 is due to slipping of the large asters into a more favorable conformation in the ellipsoid eggshell (Albertson, 1984). To test this hypothesis, the P_0 eggshell was removed by chitinase digestion. Removal of the eggshell causes the embryo to lose its ellipsoid shape and become spherical. Rotation was followed by Nomarski microscopy in four spherical P_0 embryos. In all four, the centrosome-pronuclear complex rotated (Fig. 7), suggesting that the ellipsoid shape of the eggshell is not necessary for rotation to occur. Furthermore, examination of a large number of metaphase P_0 embryos, in which the egg-

shell had been removed before rotation, demonstrated that the spindles in all the embryos were aligned along the longitudinal axis in metaphase (data not shown).

The caveat to this experiment is that in a spherical P_0 , rotation may require the presence of microfilaments. Such microfilaments may not be required by the enlarging asters inside an ellipsoid eggshell.

The Role of Microtubules in the Movement of the Centrosomes

Microtubules have previously been implicated in nuclear movements in other systems (Bestor and Schatten, 1981; Wolf, 1978). Because microtubules may have a role in the mechanism of migration/rotation, we have examined the distribution of the microtubules with respect to the cell cycle by indirect immunofluorescence using an anti-tubulin antibody (Kilmartin et al., 1982). We describe the microtubule distribution in detail for the two-cell stage (for description of the distribution in other blastomeres, see legends to Figs. 8 and 9).

During interphase the centrosomes inherited by AB and P_1 appear as small foci of tubulin staining (Fig. 9, panel 1) with a small number of microtubules emanating from the centrosome. These microtubules appear to reach the cortex of the cell. There is also an extensive network of microtubules not associated with the centrosome. Concomitant with the separation of the centrosomes, the number of microtubules associated with each centrosome increases and the number of interphase microtubules decreases (Fig. 9, panel 2). At the end of migration, a large number of microtubules emanate from each centrosome of which the majority appear to touch the cortex. This situation, in which two large asters exist at the poles and many of the microtubules extend to the cortex, persists after nuclear envelope breakdown and throughout mitosis.

The distribution of microtubules has been examined in detail during rotation in P_1 . The microtubules generally do not appear to lose contact with the cortex during rotation. Significantly, microtubules that leave the centrosome in the direction of the rotation and touch the cortex often appear straight, within the limits of resolution of immunofluorescence. Whereas others surrounding are curved (Fig. 9, panels 3 and 4). After rotation the anterior centrosome lies closely apposed to the cortex (Fig. 9, panel 5; also see Nomarski microscopy in Fig. 4, panel 6). Examination of the microtubules at this stage shows a few straight microtubules that leave the centrosome to touch the cortex whereas the others straighten as they leave the centrosome, and then bend as they approach the cortex to run along it (Fig. 9, panel 5).

The microtubule distribution has also been closely examined in P_0 during rotation. About half of embryos examined during rotation have some straight microtubules that run from the centrosome to the cortex along the direction of rotation, while other microtubules that approach adjacent regions of the cortex are bent (Fig. 8, panel 6). In the other half, all the microtubules are straight. This may correlate with the observation that rotation in P_0 proceeds in a series of discrete movements: the centrosomes and pronuclei rotate for a while, stop, and then move again (data not shown).

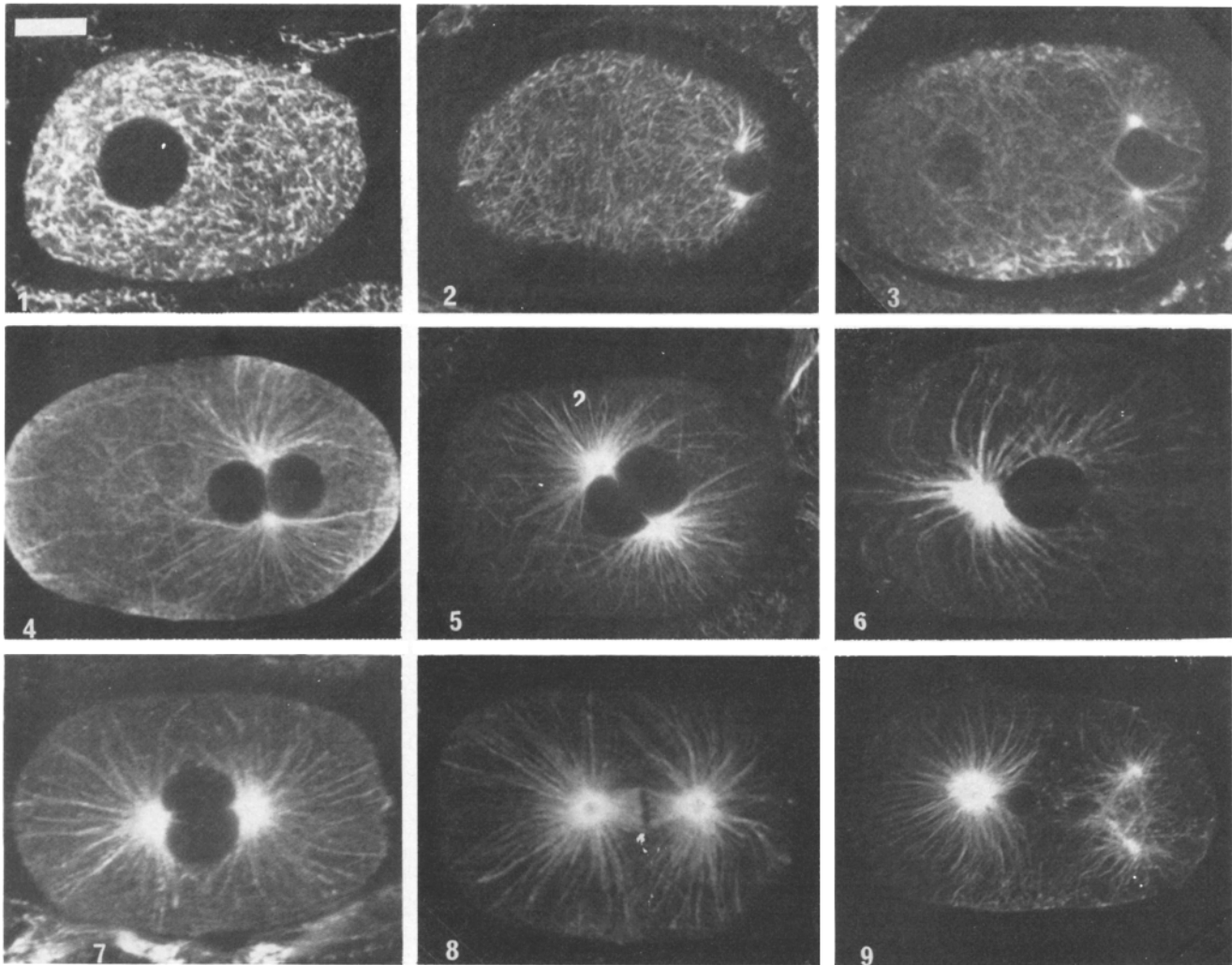

Figure 8. Illustration of the changing microtubule distributions during the development of the zygote P_0 . The anterior of the embryo is on the left, and the posterior is the right. (Panel 1) In the unfertilized oocyte all the microtubules are in the form of a cytoplasmic net. No microtubules are visible as asters. (Panel 2) The sperm has brought in one centrosome which has split, and the daughter centrosomes have migrated apart. Most of the microtubules still exist as a cytoplasmic net, but the centrosomes now nucleate small asters in which many of the microtubules extend to the cortex. (Panel 3) The female pronucleus is migrating toward the sperm pronucleus, as the sperm asters enlarge. (Panel 4) The pronuclei have met, and the asters now have many microtubules. Note that the number of microtubules in the cytoplasmic net has greatly decreased. (Panel 5) The centrosome-pronuclear complex is rotating, and many of the microtubules extend to the cortex. (Panel 6) Another example of the centrosome-pronuclear complex rotating. One of the asters is out of focus. Note that a few straight microtubules extend to the anterior, whilst the surrounding microtubules are curved. (Panel 7) After rotation; most of the cytoplasmic net of microtubules has disappeared. (Panel 8) The metaphase plate in P_0 has formed. The astral arrays are still large and the microtubules extend to the cortex. (Panel 9) Telophase. The initially spherical P_1 aster changes into an expanding ring at telophase. The ring then becomes two foci of tubulin staining which are the daughter centrosomes. Bar, 10 μm .

Migration and Rotation Are Differentially Sensitive to Microtubule Inhibitors

We have investigated the role of microtubules in the movement of the centrosomes by treating embryos with the inhibitors of microtubule polymerization, colcemid and nocodazole (Wilson and Bryan, 1974). The concentrations used initially, 50 $\mu\text{g}/\text{ml}$ colcemid (Strome and Wood, 1983) and 10 $\mu\text{g}/\text{ml}$ nocodazole, will inhibit mitosis in *C. elegans* embryos. These inhibitors, at the same concentrations, will also inhibit the polymerization of cytoplasmic microtubules in other organisms (see Dustin, 1983).

Between 10 and 20 *C. elegans* embryos were exposed to the inhibitors before, during, and after migration and rotation. Migration ceases if embryos are treated with any of the inhibitors during migration of the centrosomes, and the centrosomes appear as bright dots by staining with anti-tubulin antibody after drug treatment (data not shown).

When the drugs were applied after migration but before rotation in P_0 and P_1 , the rotation of the centrosomes was prevented and the centrosomes remained on a transverse axis, whilst the nucleus broke down. The inhibition was examined in detail on video in P_1 . After migration, the asters

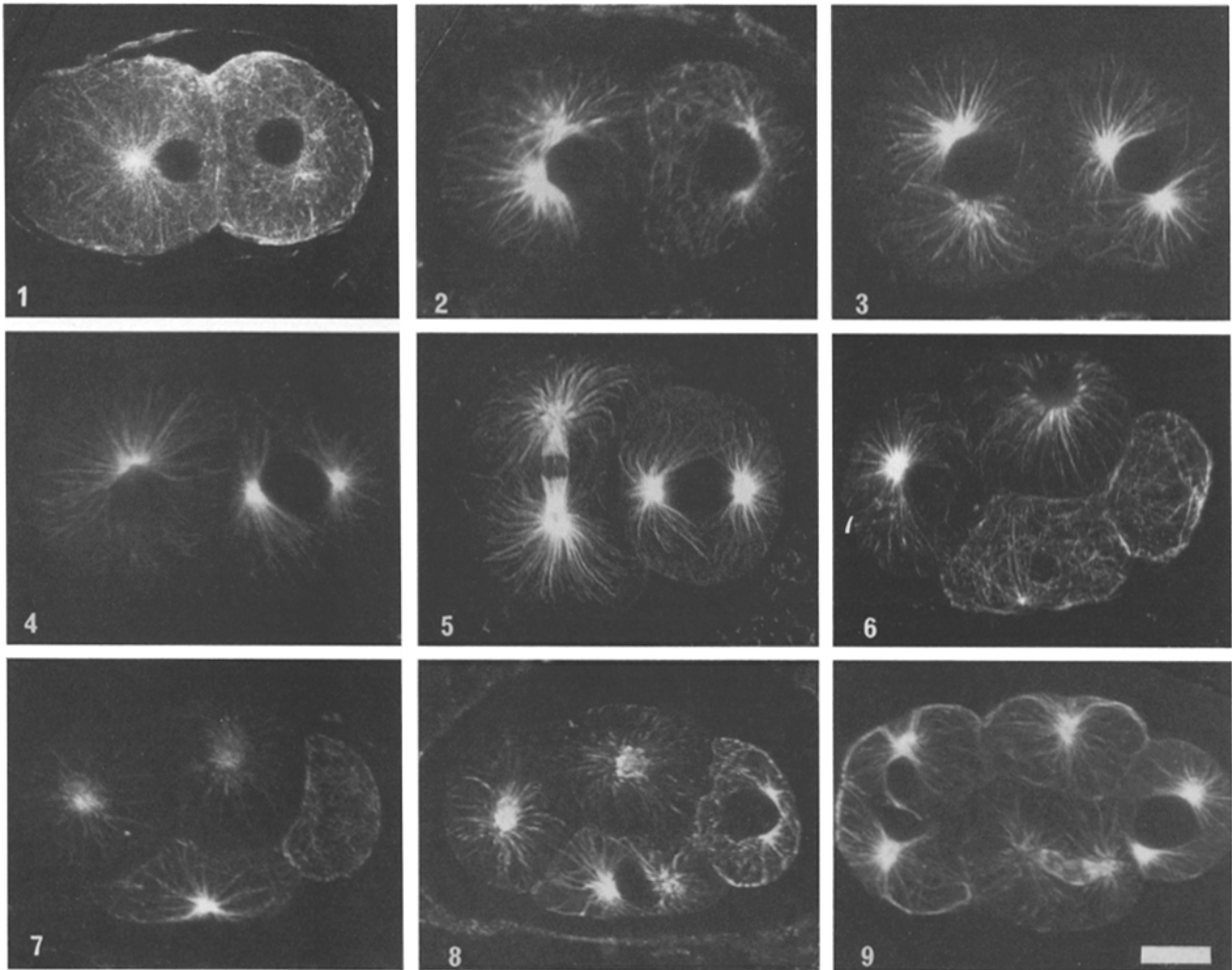

Figure 9. Distribution microtubules from the two cell egg onwards. AB is the left cell, P₁ is the cell on the right. (Panel 1) The interphase net of cytoplasmic microtubules has reformed. The P₁ centrosomes lie apart. (Panel 2) The AB centrosome has split, and the AB and P₁ centrosome pairs are migrating apart. AB is ahead of P₁ in the cell cycle by ~ 1.5 min and most of the microtubules in AB are now astral, whereas P₁ still has an extensive cytoplasmic net. (Panels 3 and 4) Rotation in P₁. A few straight microtubules leave the anterior centrosome of P₁ and touch the anterior cortex; surrounding microtubules are curved. (Panel 5) After rotation in P₁. The AB spindle has been established. In P₁ there are straight microtubules surrounded by curved microtubules that approach the anterior cortex. (Panels 6–9) Distribution of microtubules at the four-cell stage. Anaphase-B elongation of the AB spindle within the confines of the eggshell have caused the embryo to take up a tetrahedral conformation. EMS is the bottom cell. (Panel 6) The centrosomes in ABa and ABp have split and are migrating apart; the interphase net of microtubules has disappeared. In P₂ and EMS, the centrosomes appear as small foci of microtubules. (Panel 7) The EMS centrosomes are migrating apart onto the future left–right axis (see Fig. 5). One of the centrosomes is out of focus. (Panel 8) The EMS centrosomes have rotated through 90° and now lie on the anterior–posterior axis. The P₂ centrosomes have divided and are migrating apart. (Panel 9) The EMS spindle is in telophase. The P₂ centrosome–nuclear complex has rotated. Note how the P₂ centrosome lies against the P₂–EMS boundary, such that it is not possible to distinguish individual microtubules leaving the centrosome to touch the cortex: Bar, 10 μ m.

in P₁ are easily visualized by the exclusion of yolk granules. As the drug was added, the asters were seen to diminish in size, and the nucleus invariably moved to the posterior of P₁ to lie on the cortex, where the nuclear envelope broke down between transverse centrosomes (Fig. 10). In contrast the AB nucleus moved to a random position on the cortex of the cell (Fig. 10).

The effect of microtubule drugs on spindle position after rotation was examined by treating two-cell embryos with 5 μ g/ml nocodazole after rotation. The centrosome–nuclear complex was observed to leave the anterior cortex of P₁ and

drift to the posterior of the cell, where the centrosomes ended up on the transverse axis of the embryo, and the nuclear envelope broke down (data not shown).

We were interested to see whether the migration and rotation had the same sensitivities to the inhibitors. We inhibited rotation in P₁ at a concentration of 0.25 μ g/ml (data not shown). At this concentration, the migration of the centrosomes and the formation of a mitotic spindle was not prevented. Anti-tubulin staining at this concentration of nocodazole revealed a few microtubules at the centrosomes, although the number compared with untreated embryos was very vari-

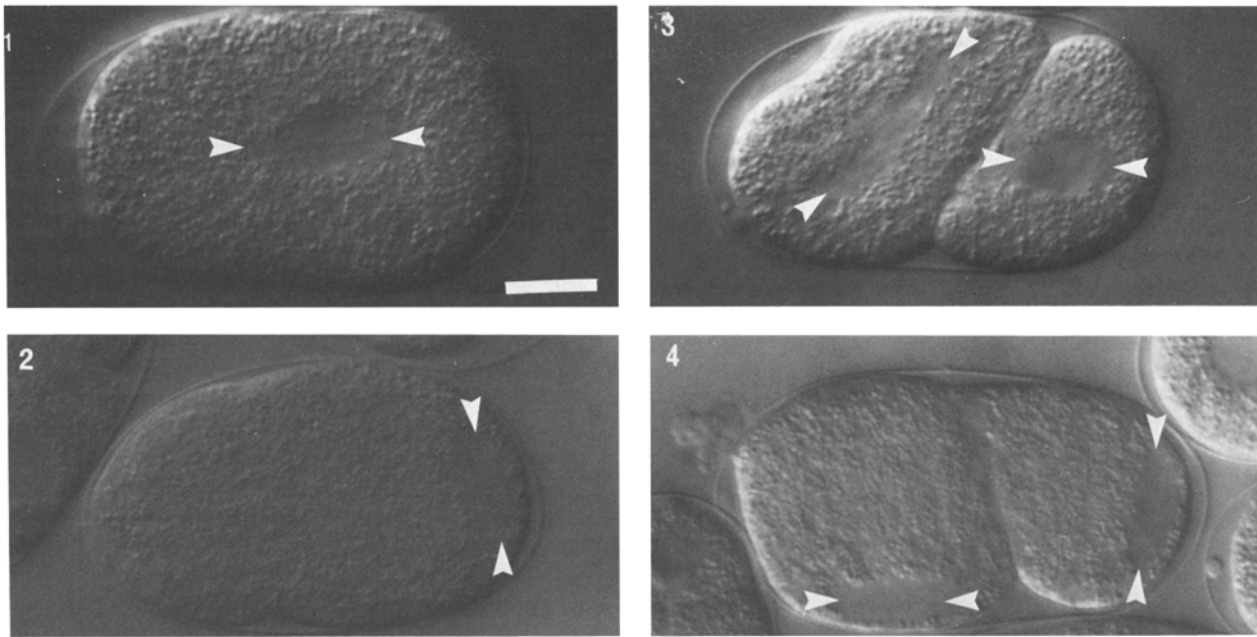

Figure 10. The effects of 20 $\mu\text{g/ml}$ nocodazole on centrosome movement. The embryos have been made permeable to nocodazole toward the end of migration by making a hole in the eggshell with a laser. White arrows mark the position of the centrosomes. (Panel 1) P_0 untreated. The mitotic apparatus is on a longitudinal axis. (Panel 2) P_0 drug treated. The centrosomes are on a transverse axis, at the posterior of the cell. (Panel 3) P_1 untreated. The mitotic apparatus is on the longitudinal axis. (Panel 4) P_1 drug treated. The centrosomes are on the transverse axis at the posterior of the cell. The AB centrosomes are lying on the transverse side of the cell in this specimen, but can lie at the anterior or posterior of the cell. Bar, 10 μm .

able (Fig. 11). The spindles of embryos treated with this concentration of nocodazole appeared attenuated; the embryo divided into many cells although many of the division axes were abnormal (data not shown).

Taxol, A Drug that Promotes Microtubule Polymerization, Prevents Rotation

To investigate whether the presence of microtubules is sufficient for rotation to occur, we treated embryos with 10 μM taxol. Taxol is a drug which has been shown to stabilize microtubules and promote their polymerization in vitro (Schiff et al., 1979). It has been previously shown to inhibit pronuclear movement in sea urchin embryos (Schatten et al., 1982). If applied in interphase of P_1 cell cycle, taxol appears to inhibit migration of centrosomes in AB but not P_1 . This could be due to the fact that the P_1 centrosome appears to split immediately after the division of P_0 (Fig. 8, panel 9). If taxol was applied during interphase, it prevents the rotation of the centrosome–nuclear complex but allows the formation of an attenuated mitotic spindle (data not shown). A possible explanation for the failure to rotate was seen in embryos treated with taxol and stained with anti-tubulin antibody (Fig. 12). In the presence of taxol an increase in the number of microtubules was observed at the centrosome, but a decrease in length was also observed, such that in P_1 the microtubules no longer appeared to extend to the cell cortex (Fig. 12). This effect on microtubule length has been previously noted in vitro (Schiff et al., 1979). Presumably it represents an enhanced efficiency of nucleation in the presence of taxol. Cytasters, foci of microtubules not emanating from a centrosome, were also seen on the cortex of the cells (Fig. 12). The appearance of cytasters after treatment with taxol

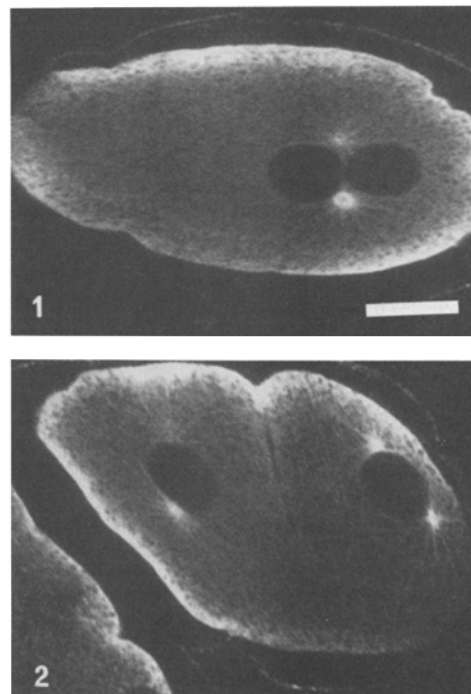

Figure 11. The distribution of microtubules after treatment of embryos with 0.25 $\mu\text{g/ml}$ nocodazole. The embryos have been made permeable by making a hole in the eggshell with a laser. Embryos were treated with the inhibitor during interphase, before migrating centrosomes were visible. They were then fixed and stained with YL 1/2. The migration of the centrosomes has not been inhibited in either P_0 or P_1 . There is a high background of unpolymerized tubulin, and a few microtubules at the centrosomes. (Panel 1) P_0 . (Panel 2) Two-cell embryo. Bar, 10 μm .

has been previously noted in sea urchins (Bestor and Schatten, 1981).

Cytochalasin D Inhibits Rotation in Some Blastomeres

To investigate the role of actin filaments in centrosome movement, embryos were treated with cytochalasin D at a concentration of 5 $\mu\text{g/ml}$. Cytochalasin D is an inhibitor of microfilament-mediated processes (Tannenbaum, 1978). The concentration chosen was sufficient to prevent cleavage in early embryos (Strome and Wood, 1983). Between 10 and 20 embryos were tested for each experiment. Examination of embryos after treatment with cytochalasin D showed that the migration of the centrosomes was not affected, the mitotic apparatus formed at their correct times, and as previously shown, nuclear divisions continue in cleavage blocked embryos (Laufer et al., 1980). However, cytochalasin D prevented rotation in P_1 , P_2 , and EMS. For example, in two-cell embryos treated with cytochalasin D, the centrosomes in AB and P_1 migrated apart, as in untreated embryos. The centrosome-nuclear complex in P_1 did not rotate, and the AB and P_1 spindles formed on transverse axes (Fig. 13). However, rotation in P_0 was not affected by cytochalasin D, even at concentrations of 40 $\mu\text{g/ml}$.

No effect on spindle position was seen if cytochalasin D was applied after rotation, even if embryos were treated with concentrations as high as 40 $\mu\text{g/ml}$ cytochalasin D (data not shown).

Discussion

The establishment of cell division axes in the early divisions of *C. elegans* was examined. In this system there is a defined spatial pattern of division of the early blastomeres in which the centrosomes can easily be seen.

The early AB divisions appear equal. Sister AB blastomeres have equivalent developmental potentials (Priess and Thomson, 1987). The AB blastomeres have an orthogonal pattern of cleavage, and our observations have shown that this pattern is generated by an orthogonal pattern of centrosome migration. After duplication the centrosomes migrate apart from one another across the surface of the nucleus. The daughter centrosomes in any one blastomere migrate on paths that are reproducibly equal and opposite. Furthermore, in each successive set of divisions of the AB blastomeres, the axis of migration is at 90° to the previous axis of migration, thus resulting in an orthogonal pattern of division. Successive orthogonal divisions are typical during embryogenesis of many organisms (Wilson, 1925). The mechanism that determines the centrosome migration paths so accurately is unknown, though it is tempting to speculate that it is related to the orthogonal orientation of the centriole pair (Costello, 1961).

The P blastomeres divide unequally and sister blastomeres have different development potentials (Laufer et al., 1980; Cowan and McIntosh, 1985; Strome and Wood, 1983; Sulston et al., 1983). These blastomeres divide successively on the same axis. We have shown that in these blastomeres the centrosomes migrate apart, but after the migration the centrosomes have an additional set of rotational movements. These occur before spindle formation, and align the centrosome-nuclear complex along the longitudinal axis of the cell.

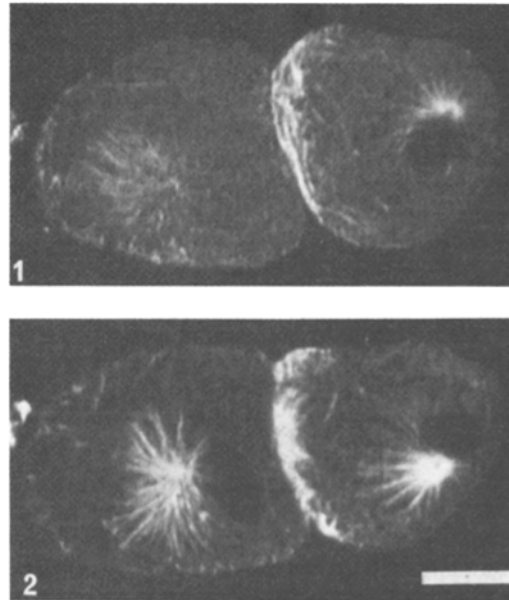

Figure 12. The distribution of microtubules at the two-cell stage after treatment with 10 $\mu\text{g/ml}$ taxol. The embryos have been made permeable by making a hole in the eggshell with a laser. Microtubules, coming from the centrosomes, are shorter than in wild-type embryos (see Fig. 7). Taxol was added during interphase. Migration is prevented in AB but not P_1 . This is probably due to the early splitting of the P_1 aster (Fig. 8, panel 9 and Fig. 7, panel 1). Numerous cytasters can also be seen associated with the anterior cortex of P_1 . More usually, the cytasters are present over the whole surface of the cortex. Bar, 10 μm .

In germ line cells this longitudinal axis corresponds to the axis of segregation of the P granules (Strome and Wood, 1983). The cleavage orientations that would be set up by the migration of the centrosomes around the nucleus alone would not allow the segregation of the majority of P granules to only one daughter in many cases. Rotation of the centrosome-nuclear complex in germ line precursors is therefore necessary for P granules to be correctly localized in only one daughter. Thus, as in other systems, the pattern of division appears necessary for the correct distribution of cytoplasmic components (Freeman, 1983).

The movement of the P granules and the rotation of the centrosomes are not necessarily connected. The movement of the P granules occurs before the axis of the mitotic apparatus is established by the rotation. Furthermore, it has been shown that the segregation of the P granules is independent of the mitotic apparatus: movement of the P granules is unaffected by drugs that prevent microtubule polymerization in the cell (Strome and Wood, 1983).

In contrast to migration, in which the centrosomes migrate apart over the surface of the nucleus, rotation involves a coordinate movement of the centrosomes and nucleus. The rotation occurs in <1 min and appears to respond to a predefined embryonic axis.

We have investigated the role of the cytoskeleton in the migration and rotation of the centrosomes. Previous workers investigating the mechanism of centrosome migration in other systems have suggested that the elongating microtubules push the centrosomes apart (Taylor, 1965). The separa-

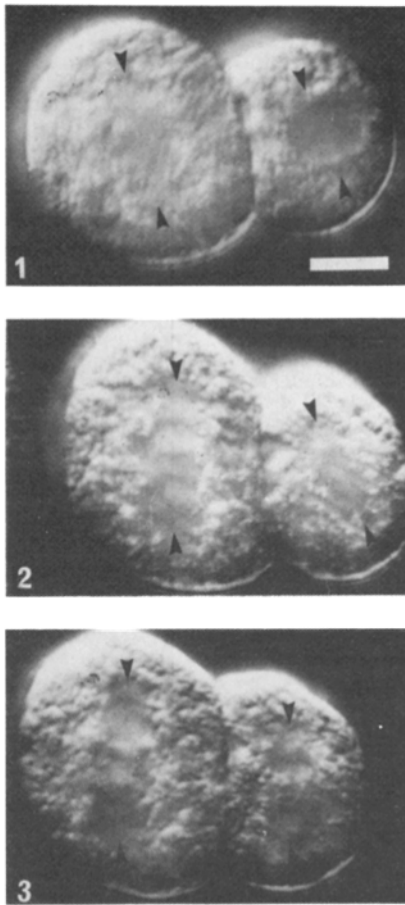

Figure 13. The effect of 5 µg/ml cytochalasin D. The effect is shown in an embryo with its eggshell removed with chitinase. (Panel 1) The AB centrosomes and P₁ centrosomes lie on the transverse axis. P₁ is the cell on the right (posterior) of the embryo. (Panel 2) The spindles of AB and P₁ lie on a transverse axis. (Panel 3) P₁ and AB have reformed their nuclei. No cleavage has taken place because cytochalasin D prevents the formation of the cleavage furrow. Bar, 10 µm.

tion of the centrosomes in Chinese hamster cells is prevented by the application of colcemid (Brinkley et al., 1967). However detailed analysis of other systems has suggested a lack of continuous microtubules between separating centrosomes (Roos, 1973; Molè-Bajer, 1975). In general it has therefore been difficult to ascribe an exact role for microtubules in centrosome migration.

Our results suggest that microtubules are involved in centrosome migration in *C. elegans*. Anti-tubulin antibody staining of separating *C. elegans* centrosomes shows what appear to be crossing microtubules between the separating centrosomes (Fig. 9, panel 2). Furthermore, the anti-microtubule drugs, colcemid and nocodazole, inhibit centrosome separation in early blastomeres. Cytochalasin D has been shown to affect centrosome separation in other systems (Euteneuer and Schliwa, 1985). However, the inhibitor has no effect on centrosome separation in *C. elegans* blastomeres, suggesting that actin microfilaments are not involved.

Rotation involves a coordinate rotation of the centrosome-nuclear complex with respect to the cell cortex. Microtubules have been implicated in nuclear movements in other

systems (Wolf, 1978; Bestor and Schatten, 1981) and in *C. elegans* (Strome and Wood, 1983). Since microtubules appear to extend from the centrosome to the cortex during rotation, they seem a likely intermediate for rotation. During rotation, the asters are large and the microtubules appear by immunofluorescence to touch the cell cortex. If the microtubule system is perturbed by using drugs, rotation is prevented. Rotation is much more sensitive to nocodazole than migration. This could either mean that rotation requires microtubules to contact the cortex, or that perturbation of polymerization is sufficient to prevent rotation. Taxol, which increases microtubule stability, has previously been shown to inhibit other movements that have been postulated to involve microtubule depolymerization (Schatten et al., 1982). The addition of taxol prevents rotation in P₁. Examination of the microtubules in P₁ shows that the effect of taxol is to promote the formation of more, shorter microtubules that no longer appear to reach to the cortex. Thus we cannot distinguish whether taxol prevents rotation by stabilizing centrosomal-cortex microtubules or by preventing microtubules from contacting the cortex.

The rotation of the centrosomes is also inhibited by cytochalasin D in all blastomeres examined except for P₀. Cytochalasin D seems to affect many of the asymmetric movements in the early embryo (Strome and Wood, 1983; Strome, S., personal communication). There is no direct evidence as to why cytochalasin D has an effect on rotation. Staining of fixed embryos with rhodamine-phalloidin has shown an extensive actin filament network under the membrane, but provides no evidence for actin filament bundles associated with the centrosomes (Priess and Hirsh, 1986; Hyman, A. A., unpublished observations).

It is possible that membrane-associated microtubules receive a motile force by interacting with an actin-myosin complex like the one associated with the membrane of ascites tumor cells (Moore et al., 1978). This would explain why cytochalasin D has no effect on spindle position after rotation. However, this does not explain why rotation occurs in P₀. Furthermore, it is difficult to see how such a mechanism could cause a reproducible angular displacement.

An alternative model that might explain the mechanism of rotation proposes that rotation occurs as a result of the depolymerization of microtubules. If there is some form of trap localized on the longitudinal poles of the cell, which can capture microtubules and promote their depolymerization, this would pull the centrosome toward that trap. This would be analogous to models proposed recently for the action of the kinetochore during anaphase (Mitchison and Kirschner, 1985). In our model microtubules are captured by a specialized structure at the cortex, and stabilized against rapid depolymerization. Depolymerization, which can occur coupled to movement of the aster, is postulated to exert a force on the aster. If the sites of attachment to the cortex are located asymmetrically, microtubule depolymerization will induce a torque and cause the rotation toward the attachment site. This model has the advantage of proposing a single explanation for the mechanism of torque and the final site of the centrosome after rotation.

The analysis of the path of centrosome movement and the position of the final placement of the centrosomes in P₁ and P₂ suggests that the centrosomes may indeed be pulled toward a region of the cortex during rotation. In P₁ one cen-

troosome is pulled toward the anterior of the cell whilst the other stays relatively still; after rotation, the anterior centrosome of P_1 stays closely apposed to the membrane. This pattern is consistent with the notion that rotation occurs because of shortening of the connection between the centrosome and the cortex.

The pattern of microtubules seen during rotation in P_1 and P_0 is consistent with the idea that the pulling is occurring via shortening microtubules. In many cases, apparently straight microtubules run in the direction of rotation surrounded by microtubules that bend as they approach the cortex. The model proposed would suggest that there is tension generated via the straight microtubules that moves the centrosome-nuclear complex around and bends the surrounding microtubules. If microtubules played only a passive role in rotation, we would expect them all to be bent.

A further piece of evidence is the behavior of the centrosome-nuclear complex after addition of microtubule drugs, whereby the centrosome-nuclear complex moves to the posterior cortex of the embryo. This suggests that depolymerization of microtubules attached to the anterior cortex may be moving the centrosomes away from their preferred position on the posterior cortex of the cell.

Is this model consistent with the current understanding of microtubule dynamics? The length of microtubules was ascertained from embryos fixed at different times during rotation. Before rotation in P_1 , the length of a microtubule extending from the centrosome to the final position of the anterior centrosome is $\sim 8 \mu\text{m}$ (Fig. 9). After rotation, it is $\sim 2 \mu\text{m}$. Assuming the rotation takes 1 min, then this gives a depolymerization rate of $6 \mu\text{m}/\text{min}$. This is faster than anaphase movement in P_1 , $\sim 4 \mu\text{m}/\text{min}$ (data not shown), but considerably slower than the depolymerization rate of free microtubules.

At present we know little about regional variation in the cortex that could generate a local site of microtubule association. The results with cytochalasin D suggest a possible role for actin.

In conclusion, analysis of the early blastomeres has shown two patterns of movement of the centrosomes. All cells show reproducible separation of the centrosomes. In certain cells there is an additional directed rotation of pairs of centrosomes and the nucleus through well-defined angles. The proposed mechanism for rotation, relying on the depolymerization of microtubules, provides a single explanation for applying the torque and defining the terminal position of the rotation. The cells in which rotation occurs are generally cells that are about to undergo differentiative divisions. In the case of P_0 , P_1 , and P_2 , the segregation of the P granules, which are components of the germ line, indicates which of the daughters carries the germ line. The centrosome-nuclear complex rotates onto the segregation axis. Thus it seems likely that one of the prime functions of the rotation is to align the mitotic apparatus along a segregation axis, thereby facilitating the unequal partitioning of the specific components into the daughter cells.

The authors would like to thank Donna Albertson, Mary Dasso, Jim Priess, and Ralph Schnabel for their help and support during this project. They would also like to thank Jonathan Hodgkin, Alfonso Martinez-Arias, Tim Mitchison, and John Sulston for critical reading of the manuscript.

Received for publication 27 January 1987, and in revised form 29 June 1987.

References

- Albertson, D. 1984. Formation of the 1st cleavage spindle in nematode embryos. *Dev. Biol.* 101:61-72.
- Bestor, T. A., and G. Schatten. 1981. Anti-tubulin immunofluorescence microscopy of microtubules present during the pronuclear movements of sea urchin fertilisation. *Dev. Biol.* 88:80-91.
- Brenner, S. 1974. The genetics of *Caenorhabditis elegans*. *Genetics*. 77:71-94.
- Brinkley, B. R., E. Stubblefield, and T. C. Hsu. 1967. The effects of colcemid inhibition and reversal on the fine structure of the mitotic apparatus of chinese hamster cells *in vitro*. *J. Ultrastruct. Res.* 19:1-18.
- Conrad, G. W., and R. Rappaport. 1981. In *Mitosis/Cytokinesis*. A. Zimmerman and A. Forer, editors. Academic Press, Inc., New York.
- Costello, D. 1961. On the orientation of centrioles in dividing cells, and its significance: a new contribution to spindle mechanics. *Biol. Bull. (Woods Hole)*. 120:215.
- Cowan, A. E., and J. R. McIntosh. 1985. Mapping the distribution of differentiation potential for intestine, muscle, and hypodermis during early development in *Caenorhabditis elegans*. *Cell*. 41:923-932.
- Davidson, E. 1976. *Gene Activity in Early Development*. Academic Press, Inc., New York. 167-215.
- Dustin, P. 1983. *Microtubules*. Springer-Verlag Berlin.
- Euteneuer, U., and M. Schliwa. 1985. Evidence for an involvement of actin in the positioning and motility in centrosomes. *J. Cell Biol.* 101:96-103.
- Freeman, G. 1983. The role of egg organization in the generation of cleavage patterns. In *Time, Space and Pattern in Embryonic Development*. W. R. Jeffery and R. A. Raff, editors. Alan R. Liss, Inc., New York. 171-196.
- Gould, R. R., and G. G. Borisy. 1977. The pericentriolar material in Chinese hamster ovary cells nucleates microtubules. *J. Cell Biol.* 73:601-615.
- Karsenti, E., and B. Maro. 1986. Centrosomes and the spatial distribution of microtubules in animal cells. *Trends Biochem. Sci.* 11:460-463.
- Kilmartin, J. V., B. Wright, and C. Milstein. 1982. Rat monoclonal anti-tubulin antibodies derived by using a new non-secreting rat cell line. *J. Cell Biol.* 93:576-582.
- Laufer, J., P. Bazzicapuso, and W. B. Wood. 1980. Segregation of development potential in early embryos of *Caenorhabditis elegans*. *Cell*. 19:569-577.
- Mazia, D., B. Palevitz, G. Sluder, and E. M. Finze. 1981. Co-operation of kinetochores and pole in establishment of non-polar mitotic apparatus. *Proc. Natl. Acad. Sci. USA*. 78:377-381.
- Mitchison, T., and M. W. Kirschner. 1985. Properties of the kinetochore *in vitro*. II. Microtubule capture and ATP dependent translocation. *J. Cell Biol.* 101:766-777.
- Molè-Bajer, J. 1975. The rôle of centrioles in the development of the astral spindle (newt). *Cytobios*. 13:117-140.
- Moore, P. B., C. L. Ownby, and K. L. Carraway. 1978. Interaction of cytoskeletal elements with the plasma membrane of sarcoma 180 ascites tumor cells. *Exp. Cell Res.* 115:331-342.
- Nicklas, R. B., and G. W. Gordon. 1985. The total length of spindle microtubules depends on the number of chromosomes present. *J. Cell Biol.* 100:1-7.
- Nigon, V., P. Guerrier, and H. Mohin. 1960. L'Architecture polaire de l'oeuf et les mouvements des constituants cellulaires au cours des premières étapes du développement chez quelques nématodes. *Bull Biol. Fr. Belg.* 93:131-202.
- Priess, J. P., and D. Hirsh. 1986. *Caenorhabditis elegans* morphogenesis: the role of the cytoskeleton in elongation of the embryo. *Dev. Biol.* 117:156-173.
- Priess, J. R., and J. N. Thomson. 1987. Cellular interactions in early *C. elegans* embryos. *Cell*. 48:241-250.
- Roos, U. P. 1973. Light and electron microscopy of rat kangaroo cells in mitosis. I. Formation and breakdown of the mitotic apparatus. *Chromosoma (Berl.)*. 40:43-82.
- Schatten, G., H. Schatten, T. H. Bestor, and R. Balczon. 1982. Taxol inhibits the nuclear movements during fertilization and induces asters in unfertilized sea urchin eggs. *J. Cell Biol.* 94:455-465.
- Schiff, P., J. Fant, and S. B. Horowitz. 1979. Promotion of microtubule assembly *in vitro* by taxol. *Nature (Lond.)*. 277:665-667.
- Sluder, G., C. L. Rieder, and F. Miller. 1985. Experimental separation of pronuclei in fertilized sea urchin eggs: chromosomes do not organize a spindle in the absence of centrosomes. *J. Cell Biol.* 100:897-903.
- Strome, S., and W. Wood. 1983. Generation of asymmetry and segregation of germ-line granules in early *C. elegans* embryos. *Cell*. 35:15-25.
- Sulston, J. E., and H. R. Horvitz. 1977. Postembryonic cell lineages of the nematode *Caenorhabditis elegans*. *Dev. Biol.* 56:110-156.
- Sulston, J. E., and J. G. White. 1980. Regulation and cell autonomy during post-embryonic development of *Caenorhabditis elegans*. *Dev. Biol.* 78:577-597.
- Sulston, J. E., E. Schierenberg, J. G. White, and J. N. Thomson. 1983. The embryonic cell lineage of the nematode *Caenorhabditis elegans*. *Dev. Biol.* 100:64-119.
- Tannenbaum, S. V. 1978. *Cytochalasins: Biochemical and Cell Biological Aspects*. Elsevier/North Holland, Amsterdam.
- Taylor, A. C. 1965. The centrioles and microtubules. *Am. Nat.* 99:267-278.
- White, J. G., W. B. Amos, and M. Fordham. 1987. An evaluation of confocal versus conventional imaging of biological structures by fluorescence light

- microscopy. *J. Cell Biol.* 105:41–48.
- Wilson, E. B. 1925. *The Cell in Development and Heredity*. MacMillan Publishing Co., New York.
- Wilson, L., and J. Bryan. 1974. Biochemical and pharmacological properties of microtubules. *Adv. Cell Mol. Biol.* 3:22–72.
- Wolf, N., J. Priess, and D. Hirsh. 1983. Segregation of germ line granules in early embryos of *Caenorhabditis elegans*: an electron microscopic analysis. *J. Embryol. Exp. Morphol.* 73:297–306.
- Wolf, R. 1978. The cytaster, a colchicine-sensitive migration organelle of cleavage nuclei in an insect egg. *Dev. Biol.* 62:464–472.