

Analysis of the Interaction Site for the Self Superantigen Mls-1^a on T Cell Receptor V β

By Ann M. Pullen,*[‡] Jerome Bill,[§] Ralph T. Kubo,*[¶]
Philippa Marrack,*[‡][¶] and John W. Kappler*[¶]

From the *Howard Hughes Medical Institute at Denver, the
[‡]Division of Basic Immunology, Department of Medicine; the
[§]Division of Basic Science, Department of Pediatrics, National Jewish Center
for Immunology and Respiratory Medicine, Denver, Colorado 80206; and the
[¶]Departments of Biochemistry, Biophysics, and Genetics, and the
[¶]Departments of Microbiology, Immunology and Medicine, University of Colorado
Health Sciences Center, Denver, Colorado 80206

Summary

Superantigen bound to major histocompatibility complex (MHC) products have been shown to stimulate T cells in a V β -specific manner. Mouse T cells bearing V β 8.1 usually respond to the self superantigen, Mls-1^a, whereas T cells bearing V β 8.2a do not. Previously, using site-directed mutational analysis, we identified the residues of natural variants of T cell receptor (TCR) V β 8.2 that conferred Mls-1^a reactivity. These residues are predicted to lie on a β -pleated sheet of the TCR V β element, well away from the expected binding site for antigen and MHC proteins. This study was undertaken to determine the effect of glycosylation on this β -pleated sheet on Mls-1^a reactivity and to map the extent of the interaction site on V β 8.2 for Mls-1^a.

A panel of T cell hybridomas expressing mutant V β 8.2 elements were tested for their responses to Mls-1^a, as well as to peptides derived from the conventional protein antigen, chicken ovalbumin. Here we demonstrate that first, N-linked carbohydrate on the lateral surface of V β blocks the interaction of the TCR V β with the self superantigen, Mls-1^a, but has no effect on the TCR interaction with peptide antigen and MHC, second, that the interaction site for Mls-1^a extends over the surface of the solvent-exposed β -pleated sheet on the side of the TCR, and third, that mutations which affect both superantigen and peptide antigen reactivity lie at the beginning of the first complementarity determining region of V β , consistent with models of the trimolecular complex of TCR-peptide-MHC.

In general, all five variable elements (V α , J α , V β , D β , and J β) of TCR- α/β are involved in recognition of peptide fragments of protein antigens presented by MHC molecules (1, 2). Recently, however, there have been several reports of T cell responses to certain antigens which are dictated primarily by the V β element of the TCR (3–15). We have coined the term “superantigen” to describe these antigens (13). There are two groups of superantigens: the self superantigens, endogenous murine products including the Mls determinants and a number of B cell-specific products, and the foreign superantigens, which encompass a variety of bacterial products produced by Staphylococci, Streptococci, and Mycoplasma (reviewed in reference 16). The superantigens are characterized by their ability to form complexes with a variety of allelic forms of class II MHC molecules and to stimulate T cells at very high frequency on the basis of the V β element of their TCRs.

We previously reported the identification of the region of

the TCR β chain that interacts with one of the self superantigens, Mls-1^a (17). Variant V β 8.2 elements, V β 8.2b, and V β 8.2c (Table 1), were identified in populations of wild mice and T cells bearing them were shown to be Mls-1^a reactive (18). Site directed mutational analysis of the V β 8.2a gene from a non-Mls-reactive T cell hybridoma allowed identification of the variant residues expressed by the wild mice that were important for conferring Mls-1^a reactivity. Since there is as yet no three dimensional structure available for the TCR, we interpreted the mutations we had generated using a model for TCR structure based on that of immunoglobulins (19). The variant residues carried by the wild mouse V β 8.2 elements that contributed to the interaction with Mls-1^a are predicted to lie on a solvent-exposed β -pleated sheet of V β , at a distance away from the CDRs that are thought to bind the complex of peptide and MHC. Fig. 1 shows a schematic representation of this β -pleated sheet of V β 8.2a viewed from the side of the TCR.

The conventional V β 8.2a element has two potential sites for N-linked glycosylation and both of these sites were affected by the variant residues which led to Mls-1^a reactivity of wild mouse T cells bearing the V β 8.2b and V β 8.2c alleles. The first aim of the present study was to determine whether carbohydrate on the solvent-exposed β -pleated sheet on the side of V β 8.2a might mask a V β interaction site for Mls-1^a. Our data show that exposure of the β -pleated sheet by loss of at least one glycosylation site is necessary, but not always sufficient, for Mls-1^a interaction. The second aim of this study was to determine which other residues on the surface of the β -pleated sheet contribute significantly to the Mls-1^a interaction site. We found these residues to be distributed over the whole area of the exposed β -pleated sheet.

Materials and Methods

Mice. All mice were purchased from The Jackson Laboratory, Bar Harbor, ME.

Cell Lines. Transfected T cell hybridomas expressing mutant V β 8.2 elements were generated as previously described (17). All the TCR mutants included in this study are shown in Table 1. DO-11.10.3 and DO-11.10.7 were used as transfection recipients. They are TCR chain loss-variants of the chicken ovalbumin specific T cell hybrid DO-11.10 (20, 21).

Analysis of T Cell Markers. Expression of receptors on T cell hybridoma transfectants was assessed by immunofluorescent staining using a collection of anti-V β 8 antibodies; anti-V β 8.1+8.2+8.3, F23.1 (22), anti-V β 8.1+8.2, KJ16 (23), anti-V β 8.2a, F23.2 (22), and the antibody specific for the idiotype of DO-11.10, KJ1 (24). The transfectants were also analyzed for their expression of CD4 using GK1.5 (25). In all cases biotinylated antibodies were used in conjunction with phycoerythrin-coupled avidin (Tago Inc., Burlingame, CA) as previously described (13).

Stimulation Assays. Transfected T cell hybridomas were screened for Mls-1^a reactivity by culturing 10⁵ hybrid cells with 10⁶ spleen cells from CBA/J (Mls-1^a), (CBA/J \times CBA/CaJ) F1 (Mls-1^{a/b}) or CBA/CaJ (Mls-1^b). Responses of the hybridomas to various doses of chicken ovalbumin peptide (cOVA)¹ 327-339 were assessed by culturing 10⁵ hybrid T cells with 10⁶ spleen cells from BALB/c (H-2^d) or C57BL/10 (H-2^b). Stimulation by solid phase anti-TCR mAbs provided controls for responsiveness of the hybrids. Microtiter wells were coated with 100 μ g/ml affinity-purified goat anti-rat IgG (H + L) (Jackson ImmunoResearch Inc., Avondale, PA) or 40 μ g/ml protein A (Sigma Chemical Co., St. Louis, MO). Subsequently, the wells were washed thoroughly and incubated with KJ16 or GM5.777-containing supernatants. After further washing of the wells, 10⁵ T cell hybrids were cultured per well. After 24 h the contents of the wells were assayed for lymphokine production using the HT-2 cell line (26). Survival of HT-2 cells was assessed using 3-[4,5-dimethylthiazol-2-yl]-2,5-diphenyltetrazolium bromide (MTT) (Sigma Chemical Co.) (27).

Production of the GM5.777 Monoclonal Antibody. TCR from the T cell hybrid 2HB51.8 (28) was purified using an immunoaffinity column bearing a mAb (H28-710) specific for C α (29). 2HB51.8 expresses four TCR chains, V α 1- and V β 1-bearing chains from the fusion partner BW5147, as well as V α 10- and V β 5.1-bearing

chains. Armenian hamsters were immunized five times with purified receptor. B cell hybridomas were produced by fusing spleen cells from one of the hamsters with the variant myeloma line P3X63AG8.653/3. The primary B cell hybrid supernatants were screened for binding to 2HB5.18 in an ELISA and the secondary screen employed staining the same T cell hybrid with the antibody-containing supernatants followed by FITC-coupled protein A (Sigma Chemical Co.). One mAb, GM5.777, stained 2HB51.8 and was cloned for further use.

To determine the specificity of GM5.777, the antibody was used to stain a panel of T cell hybrids expressing different TCRs, derived from C57BL/10 (30). GM5.777 reacted with the majority of hybrids generated with BW5147 (22/25), whereas it did not react with any of those generated using an α chain loss variant of BW5147 (0/29) (31), suggesting that the antibody may be binding to an epitope present on the BW-derived V α 1-bearing chain or to a combinatorial determinant generated by the V α 1 and V β 1 chains contributed by BW. Since GM5.777 did not bind significant numbers of peripheral T cells from AKR or C57BL/10 (data not shown), it is unlikely that the antibody is specific for V α 1 elements.

Surface Labeling of Cells. Cell surface iodination of transfected T cell hybrids was performed by the chemical reaction catalyzed by Iodogen (Pierce Chemical Co., Rockford, IL) as previously described (32). Cell lysates were subsequently prepared by detergent lysis in 1% NP-40 (32) and debris was removed by centrifugation at 12,000 g for 20 min.

Immunoprecipitation. To immunoprecipitate individual α and β chains of the TCR, the cell lysates were subjected to reduction and alkylation. The NP-40 lysates were reduced with 0.05 M 2-ME for 1 h at 4°C and subsequently alkylated with 0.15 M iodoacetamide at pH 8, for 1 h. Under these conditions immunoprecipitation of the lysate with anti- β chain reagents results in the precipitation of β chains only (R.T. Kubo, unpublished observations).

N-Glycanase Treatment. Immunoprecipitates were washed in 0.1 M sodium phosphate buffer, pH 8.6, and were resuspended in this buffer containing 0.5% SDS, pH 8.6, and boiled for 3 min. After centrifugation the supernatant was removed and divided into two samples. The samples were adjusted to 1% NP-40 and 6 μ l 50% glycerol/2.5 mM EDTA, with or without 1.5 U N-glycanase (Genzyme, Boston, MA), were added, as previously described (33). After overnight incubation at 37°C, an equal volume of 2 \times Laemmli sample buffer (34) was added to the samples before electrophoretic analysis on 11% SDS polyacrylamide gels under reducing conditions.

Results

In these studies on the effects of amino acid substitutions in V β on the specificity of T cells bearing a particular T cell receptor, we chose to use derivatives of the T cell hybridoma DO-11.10. DO-11.10 was created by fusion of a T cell specific for cOVA and IA^d with the thymoma BW5147 (20). DO-11.10 reacts with cOVA/IA^d, weakly with IA^b and cOVA/IA^b and does not react with Mls-1^a. It expresses TCR chains bearing V α 13 and V β 8.2a, derived from the normal T cell parent, and V α 1 and V β 1, derived from BW5147. Two derivatives were used in these experiments, DO-11.10.3, which has lost the gene encoding the V β 8.2a-bearing β chain, and DO-11.10.7, which has lost this β chain gene and the gene encoding the V α 13-bearing α chain (21). The products of β chain genes transfected into DO-11.10.3 may therefore pair with either of the two endogenous α chains, while products

¹ Abbreviations used in this paper: cOVA, chicken ovalbumin; SE, Staphylococcal enterotoxins.

Table 1. *Vβ8.2 Mutants and Summary of Their Reactivity to Mls-1^a*

Mutation	Vβ	Amino acids mutated												Mls-1 ^a reactivity
		16	17	18	20	22	24	51	65	70	71	72	73	
Wild type	8.2a	K	V	T	S	N	T	D	S	E	N	F	S	-
22N→D	8.2b	D	+
16K→A/22N→D		A	.	.	.	D	+
16K→N/22N→D		N	.	.	.	D	(+)
17V→S/18T→V/22N→D		.	S	V	.	D	-
18T→N/22N→D		.	.	N	.	D	(+)
22N→D/24T→Y		D	Y	-
22N→Q		Q	(+)
24T→A		A	-
22N→D/70E→K/71N→E		D	.	.	.	K	E	.	.	+++
22N→D/51D→G/70E→K/71N→E	8.2c	D	.	G	.	K	E	.	.	+++
70E→K/71N→E		K	E	.	.	++
70E→K/71N→E/65S→V		V	K	E	.	.	++
70E→K/71N→E/72F→S		K	E	S	.	++
70E→K/71N→E/73S→I		K	E	.	I	++
70E→K		K	.	.	.	-
71N→E		E	.	.	-
71N→Q		Q	.	.	-
73S→A		A	-
70E→K/73S→A		K	.	.	A	+

N designates a potential N-linked glycosylation site.
(+) A weak response to CBA/J spleen cells.

of the β chain genes transfected into DO-11.10.7 can only pair with the BW-derived α chain. These derivatives were transfected with genes encoding β chains with various mutations in Vβ8.2 (Table 1) and the transfectants were examined for the properties and specificities of the TCRs thus generated.

Carbohydrate on Vβ8.2 Elements Blocks the Interaction of TCRs with Mls-1^a. We have previously reported a number of mutations that revealed amino acids important for conferring Mls-1^a reactivity. The mutation 22N→D or the pair of mutations 70E→K/71N→E conferred Mls-1^a reactivity to the otherwise non-Mls-1^a-reactive, Vβ8.2a-bearing, T cell hybrid, DO-11.10 (17). Both mutations 22N→D and 71N→E destroyed potential glycosylation sites on the Vβ8.2a element expressed by laboratory inbred mouse strains. To address whether glycosylation at one or both of these sites blocks a potential binding site for Mls-1^a on Vβ8.2a we generated a panel of transfectants expressing mutant Vβ8.2 elements in which the potential glycosylation sites were destroyed. The consensus tripeptide sequence for an N-linked glycosylation site is N X S/T (where X is any amino acid): thus to prevent glycosylation these sites were altered by N→Q mutation or, alternatively, by S→A or T→A mutation.

To determine whether the potential glycosylation sites on the Vβ8.2 element were indeed glycosylated, the TCR chains from I¹²⁵ surface-labeled hybrids expressing transfected normal or mutant β genes were analyzed. The cells were surface labeled and lysed as described in the Materials and Methods. Reduction and alkylation of the lysates resulted in the dissociation of the α and β chains of the TCR such that subsequent immunoprecipitation using mAbs specific for the β chain resulted in only β chains in the immunoprecipitate (R.T. Kubo, unpublished observation).

The results of the F23.1 immunoprecipitation for four transfected hybrids are shown in Fig. 2 A. The mutant β chains 22N→Q and 71N→Q ran with slightly higher mol wt than the mutant β chain 22N→D/70E→K/71N→E (compare lanes 2 and 3 with 4) that had no potential Vβ glycosylation sites, indicating that N-linked carbohydrate could be present on residues 71 or 22. If both of the potential glycosylation sites on the Vβ8.2a element were glycosylated, then the molecular mass of the wild type Vβ8.2a-bearing β chain would be expected to be greater than that of mutant β chains 22N→Q or 71N→Q, however this was not seen to be the case (compare lane 1 with lanes 2 and 3, Fig. 2 A). The Vβ8.2a β chain ran as a broad band with a molecular mass of about

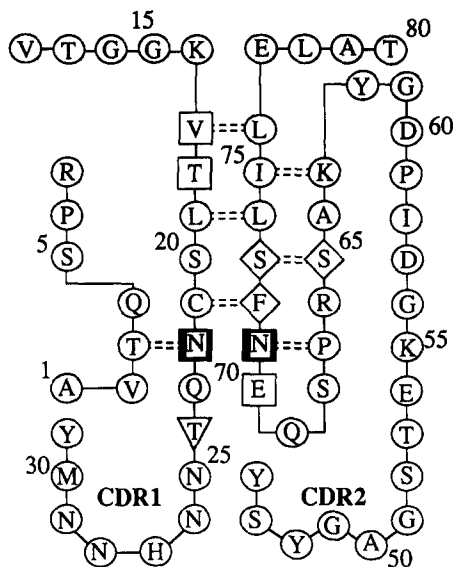

Peptide Antigen + MHC Binding Site

Figure 1. Schematic representation of the view from the side of the TCR V β 8.2a element. The schematic is adapted from the model proposed by Chothia et al. (19). Mutations at these positions (∇) disrupt TCR-class II interactions, (\square) affect TCR-Mls-1 α interactions and (\diamond) are not critical for TCR-Mls-1 α interactions. Shaded squares designate glycosylation sites.

43 kD. It is possible that both potential sites on V β 8.2a are not always glycosylated on each TCR molecule.

After N-glycanase treatment the β chains from all four hybrids ran with the same molecular mass of \sim 32 kD (lanes 5–8), indicating that the mutations had not affected the mobility of the polypeptide chains. The drop in molecular mass from the untreated mutant β chain 22N \rightarrow D/70E \rightarrow K/71N \rightarrow CE to the N-glycanase-treated bands (compare lane 4 with lanes 5–8) is due to the presence of three N-linked carbohydrate moieties on C β (35).

Transfected hybridomas were matched for their levels of expression of the mutant gene products using the antiidio-

Table 2. Response of Transfectants to Mls-1 α Expressing Spleen Cells

Transfectants	IL-2 production	
	DO-11.10.3 (V α 1, V α 13)	DO-11.10.7 (V α 1)
	U/ml	
V β 8.2a	-	-
22N \rightarrow D	>640	-
22N \rightarrow Q	40	-
24T \rightarrow A	-	-
71N \rightarrow Q	-	-
73S \rightarrow A	-	-
70E \rightarrow K/71N \rightarrow E	>640	>640

-, \leq 10 IL-2 U/ml.

All transfectants responded to KJ16-stimulation by generating \geq 640 IL-2 U/ml.

typic antibody, KJ1 (24), which will detect V α 13/V β 8.2 $^+$ TCRs, or the anti-V β 8 antibody, F23.1 (22), which will detect V β 8.2 $^+$ β chains paired with any α chain. The DO-11.10.3 transfectants all had high levels of the accessory molecule CD4 while the DO-11.10.7 transfectants all had low levels of CD4 (17). These transfectants were all tested for their ability to respond to Mls-1 α presented by CBA/J spleen cells. The DO-11.10.3 transfectant expressing mutation 22N \rightarrow Q (which prevented glycosylation at position 22) responded to Mls-1 α stimulation, while the DO-11.10.7 transfectant expressing the same mutation did not (Table 2). This result was reminiscent of our previous finding that DO-11.10.3/22N \rightarrow D was Mls-1 α reactive whilst DO-11.10.7/22N \rightarrow D was not (17). It is possible that these mutant V β 8.2 chains impart Mls-1 α reactivity when they pair with the V α 13-containing but not with the V α 1-containing α chain, or alternatively, it may be that the mutant receptor is sufficient to confer Mls-1 α reactivity only in the presence of high levels

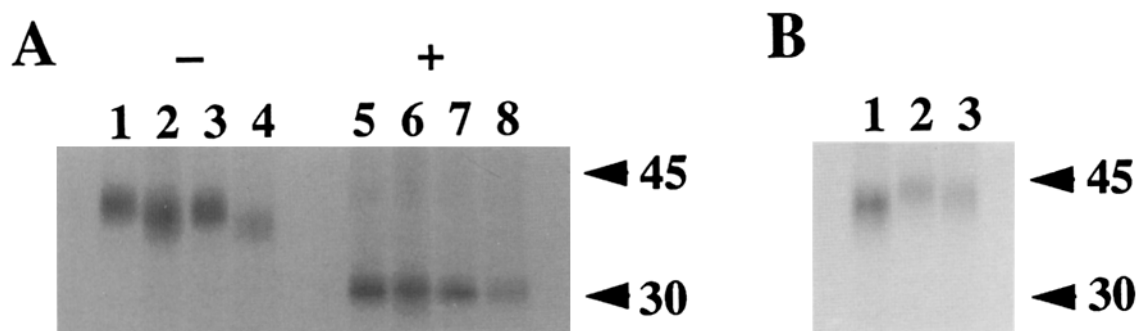

Figure 2. Glycosylation of V β 8.2 elements. Transfectants were [125 I]-surface labeled and lysed. Lysates were then reduced and alkylated, subsequently TCRs were immunoprecipitated with F23.1, N-glycanase treated (+) or not (-), and were analyzed on 11% SDS-PAGE. (A) Glycosylation of V β 8.2 at positions 22 and 71. Lanes 1 and 5, DO-11.10.7/V β 8.2a; lanes 2 and 6, DO-11.10.7/22N \rightarrow Q; lanes 3 and 7, DO-11.10.7/71N \rightarrow Q; lanes 4 and 8, DO-11.10.7/22N \rightarrow D/70E \rightarrow K/71N \rightarrow E. (B) Glycosylation of V β 8.2 at positions 16 or 18, and 71. Lane 1, DO-11.10.3/22N \rightarrow D; lane 2, DO-11.10.3/16K \rightarrow N/22N \rightarrow D; lane 3, DO-11.10.3/18T \rightarrow N/22N \rightarrow D. Positions of mol wt markers are indicated and represent 45 kD (ovalbumin) and 30 kD (carbonic anhydrase).

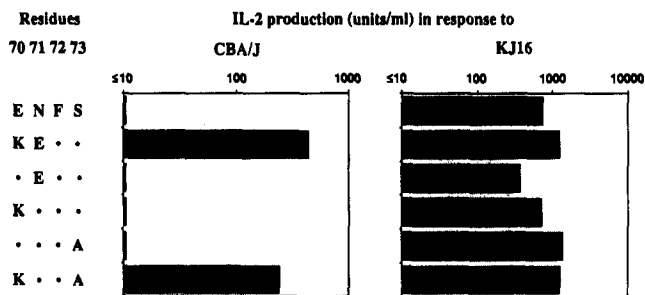

Figure 3. Response of DO-11.10.3 transfectants to Mls-1^a and KJ16-stimulation. IL-2 responses to CBA/J spleen cells were assessed as described in the Materials and Methods. <math>< 10</math> IL-2 U/ml were generated in response to CBA/CaJ spleen cells. Mutations generated were variants of V β 8.2a. Data shown are from a representative experiment. Transfectants were assayed in at least three experiments.

of the accessory molecule CD4. These results suggest that prevention of N-linked glycosylation by mutations 22N \rightarrow D and 22N \rightarrow Q facilitates the interaction of the V β 8.2-containing TCR with Mls-1^a.

Neither of the transfectants expressing mutation 24T \rightarrow A responded to Mls-1^a stimulation (Table 2), suggesting that prevention of glycosylation at position 22 was alone insufficient to confer Mls-reactivity and that 24T may be critical for this reactivity. This possibility is addressed in more detail below.

Mutations 71N \rightarrow Q and 73S \rightarrow A also did not confer Mls-1^a reactivity (Table 2), demonstrating that prevention of glycosylation at position 71 was not sufficient to confer Mls-1^a reactivity on V β 8.2a. However, the analysis of more mutations designed to determine exactly which residue(s) carried by the variant V β 8.2c allele contribute to its Mls-1^a-reactivity suggested that preventing glycosylation at position 71 was necessary to unmask a potential interaction site for Mls-1^a on this V β .

In our previous study we determined that the pair of mutations 70E \rightarrow K/71N \rightarrow E, carried by the variant V β 8.2c allele, conferred Mls-1^a reactivity upon both DO-11.10.3 and DO-11.10.7 transfectants (17). These mutations would, of course, remove the N-linked glycosylation site at position 71 and also introduce a charge change at position 70. To test which of these changes was required to confer Mls-1^a-reactivity on V β 8.2-bearing T cells we generated transfectants expressing these mutations singly. In addition we also produced a transfectant which carried the pair of mutations 70E \rightarrow K/73S \rightarrow A. This V β element had the positively charged lysine residue at position 70 and could not be glycosylated at the adjacent asparagine residue since the consensus sequence had been altered. The reactivity patterns for these hybridomas are shown in Fig. 3. Alone, neither of the charged residues at 70 or 71 conferred Mls-1^a reactivity, however mutant 70E \rightarrow K/73S \rightarrow A was reactive. This suggested that it was necessary to prevent glycosylation at position 71 in order to facilitate the interaction of Mls-1^a with the positively charged lysine at position 70. Further, the magnitude of the response of mutant 70E \rightarrow K/73S \rightarrow A was reproducibly two-fold lower than that of mutant 70E \rightarrow K/71N \rightarrow E, implying

that either 71E or 73S may also facilitate the interaction with Mls-1^a.

Addition of Novel Glycosylation Sites in V β 8.2b Reduces Mls-1^a Reactivity. In light of our findings that N-linked carbohydrate at position 22 masked an interaction site for Mls-1^a on V β 8.2a, and that carbohydrate at position 71 prevented the interaction of the lysine residue carried by the V β 8.2c allele with Mls-1^a, we investigated the effect of introducing new potential glycosylation sites elsewhere on the solvent exposed β -pleated sheet of V β 8.2b. DO-11.10.3 transfectants carrying the V β 8.2b allele (mutant 22N \rightarrow D), had previously been generated and shown to be Mls-1^a reactive (17). Asparagine residues were substituted at positions 16 or 18 in V β 8.2b to introduce novel potential N-linked glycosylation sites. V β 1 is glycosylated at position 18, whilst none of the known V β elements have a potential glycosylation site at position 16.

SDS-PAGE analysis of F23.1 immunoprecipitated β chains from I¹²⁵ surface-labeled transfectants bearing these mutant β chains (Fig. 2 B) showed that mutant β chains 16K \rightarrow N/22N \rightarrow D and 18T \rightarrow N/22N \rightarrow D had higher molecular masses than the V β 8.2b-bearing β chain (mutant 22N \rightarrow D) (compare lanes 2 and 3 with lane 1), indicating that N-linked glycosylation did indeed occur at these novel sites.

These transfectants expressing mutant V β 8.2 elements with N-linked carbohydrate present at position 71 and either position 16 or position 18 were screened for Mls-1^a reactivity, using CBA/J spleen cells as stimulators. They showed diminished responses compared to mutant 22N \rightarrow D (Fig. 4), that is only glycosylated at position 71. To assess further this reduction in Mls-1^a responsiveness, in subsequent experiments (CBA/J \times CBA/CaJ)F₁ spleen cells were also included as stimulators. These stimulators were heterozygous for Mls-1^a and so are predicted to express half the level of the stimulatory ligand. As shown in Fig. 4 the mutants with novel glycosylation at positions 16 or 18 did not respond to the F₁ spleen cells, confirming their reduced responsiveness to Mls-1^a.

In general the TCR mutations generated in this study did not grossly alter the conformation of the TCR as judged by the staining profiles with monoclonal antibodies F23.1 and F23.2, which react with TCRs including all V β 8s or V β 8.2a,

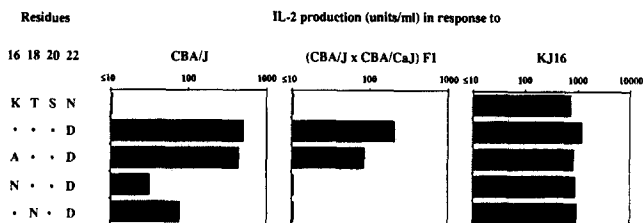

Figure 4. Response of DO-11.10.3 transfectants to Mls-1^a, Mls-1^{a/b} and KJ16-stimulation. Mutations generated were variants of V β 8.2b (mutant 22N \rightarrow D). Sequence comparisons are made to V β 8.2a. Data shown are from a representative experiment. Transfectants were assayed for responsiveness to CBA/J in at least three experiments and to (CBA/J \times CBA/CaJ) F₁ in two experiments.

respectively, and with the antiidiotypic antibody, KJ1. It should be noted, however, that mutation 16K→N introduced an additional N-linked carbohydrate that caused the disruption of the binding site of another mAb, KJ16, specific for Vβ8.1 and Vβ8.2s. KJ16 staining of the DO-11.10.3/16K→N/22N→D was undetectable (data not shown), but this transfectant did respond to stimulation by KJ16 bound to goat anti-rat Ig antibodies coated on culture wells (Fig. 4), suggesting that KJ16 did bind weakly to the mutant TCR.

The Mls-1^a Interaction Site on Vβ8.2 Extends Over the Solvent-Exposed β-Pleated Sheet On the Side of the TCR. To determine the extent of the Mls-1^a interaction site on the solvent-exposed β-pleated sheet on the side of the TCR, mutations were introduced into Mls-1^a reactive Vβ8.2 elements which we had already generated. Transfectants expressing these mutant Vβs were then analyzed for Mls-reactivity. Loss of Mls-1^a reactivity would suggest that the mutated residues were critical for the interaction with Mls-1^a.

Instead of introducing random mutations in the Vβ elements, the available sequences of Vβ elements were compared for residues that are conserved among Mls-1^a reactive Vβs but that are substituted in non-Mls-reactive Vβs. Three amino acids stood out as being possible contributors to the Mls-1^a interaction site: 65S and 73S are present in all inbred mouse strain Vβs known to be Mls-1^a reactive (Vβs 6, 7, 8.1, and 9) (4, 5, 9–12), and 72F is present in Vβs 6, 7, and 8.1. Few of the non-Mls-reactive Vβ elements carry these residues at these positions. We introduced mutations 65S→V, 72F→S, or 73S→I into the Vβ8.2 mutant element already known to confer strong Mls-1^a reactivity, mutant 70E→K/71N→E. In the hope that the TCR would maintain its gross structure in spite of these additional mutations, the residues chosen for substitution occurred in at least one other Vβ element. For example, 72S is present in Vβs 5.1, 5.2, 11, 12, 13, and 15. As shown in Fig. 5 none of these mutations reduced the magnitude of the response to CBA/J stimulator cells, demonstrating that none of these residues appeared critical for the Mls-1^a reactivity of this particular Vβ8.2 element.

Residues 16K, 17V, 18T, and 24T are present in at least two of the Mls-1^a-reactive Vβ elements, and therefore mutations of these residues were introduced into the previously

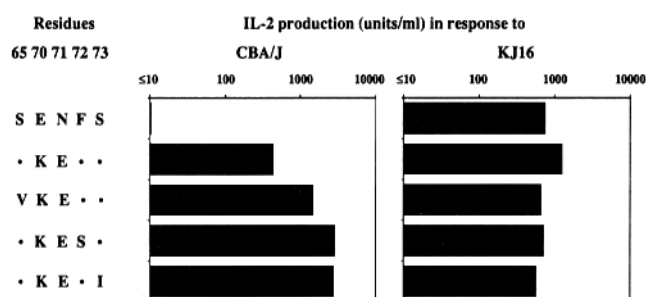

Figure 5. Response of DO-11.10.3 transfectants to Mls-1^a and KJ16-stimulation. Mutations generated were variants of mutant 70E→K/71N→E. Sequence comparisons are made to Vβ8.2a. Data shown are from a representative experiment. Transfectants were assayed in at least three experiments.

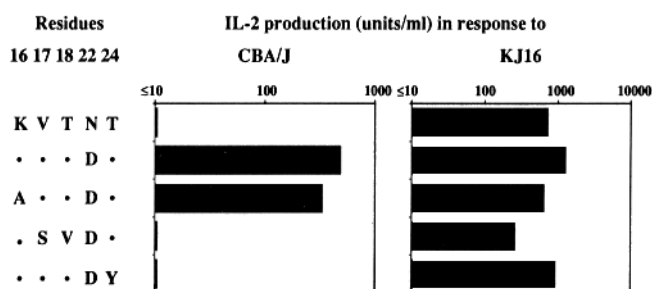

Figure 6. Response of DO-11.10.3 transfectants to Mls-1^a and KJ16-stimulation. Mutations generated were variants of Vβ8.2b (mutant 22N→D). Sequence comparisons are made to Vβ8.2a. Data shown are from a representative experiment. Transfectants were assayed in at least three experiments.

generated Mls-1^a-reactive Vβ8.2b element (mutant 22N→D). Mutation 16K→A had no effect on the Mls-1^a reactivity of the Vβ8.2b element. However, mutation 24T→Y, or the pair of mutations 17V→S/18T→V, were sufficient to prevent Mls-1^a reactivity (Fig. 6), indicating that 24T, and 17V, or 18T are critical for Mls-1^a reactivity of Vβ8.2b. Thus, residues 17 or 18, and 24, as well as residues 22, 70, and 71, contribute to Mls-1^a reactivity of Vβ8.2-bearing TCRs. All these residues lie on the solvent-exposed β-pleated sheet on the side of the TCR (Fig. 1).

Mutations at Position 24 Alter Reactivity to Peptide Antigen-MHC. There are three possible explanations for the observed loss of Mls-1^a reactivity due to mutations 24T→Y and 17V→S/18T→V. First, the introduced mutations may have grossly distorted the structure of the TCR, second, they may have perturbed the interaction of the TCR with the MHC class II molecule presenting the superantigen, Mls-1^a, or third, they may have disrupted the interaction of the TCR with Mls-1^a.

Transfectants bearing these mutant Vβ8.2 elements continued to stain with mAbs specific for Vβ8.2 (F23.1, KJ16 and F23.2) and the antiidiotypic antibody (KJ1) suggesting

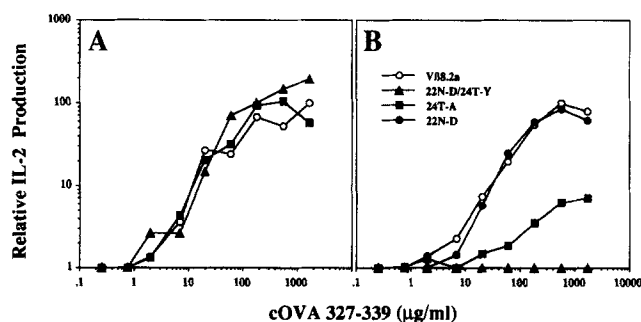

Figure 7. Response of DO-11.10.3 transfectants to chicken ovalbumin peptide 327-339. Peptide 327-339 was presented by (A) BALB/c spleen cells (IA^d) or by (B) C57BL/10SNJ spleen cells (IA^b). Results shown in A and B were obtained in two separate experiments and are expressed relative to the maximal response of the transfectant carrying the wild type DO-11.10 receptor (Vβ8.2a).

that the TCR structure was not grossly distorted by the 24T→Y or 17V→S/18T→V mutations (data not shown).

To assess the effect of these mutations upon the interaction of the TCR with class II, the responses of the transfectants to peptides of the conventional protein antigen cOVA were measured. There were no shifts in the dose response curves for any of the mutant TCRs when the cOVA peptide 327-339 was presented by the IA^d molecule (Fig. 7 A and data not shown), suggesting that none of the mutations caused major perturbation of the TCR interaction with this class II molecule.

The measurement of the cross-reactive response of the transfectants to cOVA peptides presented by IA^b was hindered by a weak background response in the absence of added cOVA peptide. This response to IA^b is contributed by TCRs composed of the BW-derived Vα1-containing α chain and the Vβ8.2-containing β chain (21). Inclusion of supernatant containing mAb GM5.777 in the stimulation cultures blocked this weak anti-IA^b response (Table 3), confirming that the antibody specificity was indeed for an epitope on the Vα1-bearing α chain of BW. The use of this antibody facilitated the assessment of the response of the transfectants to added peptides, and indeed it may prove useful in dissecting the reactivities of other hybrids generated using the T cell fusion partner, BW5147.

Mutation 24T→Y caused at least a 100-fold shift in the dose response curve to the cOVA peptide presented by IA^b (Fig. 7 B). Transfectants expressing the 24T→A mutation, that had been generated to investigate the role of glycosylation at position 22, also showed a diminished response (at least 10-fold) to cOVA peptides presented by IA^b (Fig. 7 B). These data suggest that mutations at position 24 perturb the interaction of the TCR with the IA^b molecule. The loss of Mls-1^a reactivity of Vβ8.2b due to mutation 24T→Y (Fig. 6) may therefore be due the disruption of the TCR/class II interaction during the presentation of Mls-1^a.

The paired mutations 17V→S/18T→V did not affect the response to cOVA peptide presented by IA^b (data not shown), although they ablated the response to Mls-1^a (Fig. 6). This suggests that these mutations disrupt the interaction of the TCR with Mls-1^a, and not the interaction of the TCR with MHC.

Discussion

This paper concerns the structure of the trimolecular complex formed between TCRs, class II MHC proteins and the self superantigen, Mls-1^a. The structures of two of the components of the complex, TCR and class II, have been modeled on the known structures of immunoglobulin and class I MHC, respectively, and there is some evidence to support the conclusions thus drawn (19, 36-39). Until very recently, the molecular nature of Mls-1^a was unknown. We have just shown, however, that another mouse self superantigen is encoded by a mouse mammary tumor virus (reference 40 and Y. Choi, J.W. Kappler, and P. Marrack, manuscript in preparation) and it is likely that Mls-1^a and other self superantigens will be closely related. The complex studied in this paper is therefore formed between three proteins, two of which are known to be globular in nature.

Models of the TCR based on the structure of immunoglobulin suggest that a solvent-exposed lateral surface of the molecule is formed by a β-pleated sheet made up of amino acids of Vβ. This surface is predicted to be well away from the residues in the CDRs, thought to contact antigenic peptides and MHC, and is also well away from the contact region between Vα and Vβ. Recent experiments have suggested that it is this face of Vβ that binds superantigens (17, 41, 42). We showed that mutant forms of Vβ8.2 found in wild mice probably engage Mls-1^a with amino acids in this face (17). Variant forms of Vβ17a isolated from wild mice by Cazenave et al. (41) had lost the ability to react with a mouse superantigen plus IE, and one of the amino acids contributing to the loss would also lie on the exposed β-pleated sheet of Vβ at position 71 by the numbering system used in this paper.

Other studies on receptor-ligand interactions indicate that protein-protein interactions often occur over fairly large surfaces, with contact points formed between many amino acids on either protein (43, 44). The experiments reported here suggest that this is also true for the interaction between Vβ8.2 and Mls-1^a. For example, the presence of a lysine at position 70 of Vβ8.2 conferred Mls-1^a reactivity upon T cells bearing it, providing an adjacent glycosylation site had also been destroyed. Valine 17 and/or threonine 18 contributed to the Mls-1^a reactivity of this variant Vβ and our results also in-

Table 3. mAb GM5.777 Blocks the Response of DO-11.10 to IA^b

T cell hybrid	T cell receptor chains				IL-2 production in response to IA ^b stimulation				
	Vα1	Vβ1	Vα13	Vβ8.2	None	Antibody present			
						KJ1 (anti-id)	KJ16 (anti-Vβ8)	GM5.777 (anti-BWα)	KJ25 (anti-Vβ3)
DO-11.10	+	+	+	+	40	40	-	-	40
DO-11.10.3	+	+	+	-	-	-	-	-	-

IL-2 production is expressed as U/ml; -, < 10 IL-2 U/ml.

Both T cell hybrids responded to GM5.777 stimulation by generating ≥640 IL-2 U/ml.

indicated that a glutamic acid at position 71 or a serine residue at 73 might also enhance binding of the same variant. As illustrated in Fig. 1, these residues are predicted to lie quite far apart on the solvent-exposed β -pleated side of V β .

The data also suggested that although V β 8.2 and Mls-1^a could interact over a large area, it was not always essential that residues over the whole area be engaged. In some mutants one part of the β -pleated sheet on the side of V β contributed to binding, in other mutants a different part of the sheet was more important. T cells bearing V β 8.2 that lack the glycosylation site at position 22 could react with Mls-1^a even though the β chain did not bear a lysine at position 70. In the presence of glycosylation at position 22 however, the absence of glycosylation at position 71 and a lysine at position 70 were required for Mls-1^a reactivity.

It is likely that the mutations introduced at these positions affected Mls-1^a reactivity because of direct effects on the binding of V β 8.2 to Mls-1^a, rather than because of gross distortions of the TCR. The products of all these mutations continued to react normally with 'OVA/IA^d and moreover also continued to react well with at least three of four monoclonal anti-V β antibodies.

Mutations in several of the amino acids which lie on the solvent-exposed β -pleated sheet of V β , that are conserved in V β s known to react with Mls-1^a (65S, 72F, and 73S), did not affect reactivity in these experiments. Perhaps the changes chosen were not disruptive enough: for example, no charge changes were introduced by any of these mutations.

Among the most striking findings in these and our previous studies were the discoveries that the interaction site on V β for self superantigens lies on the side of V β , and that it can be masked by N-linked carbohydrates. The finding that N-linked carbohydrate may conceal a potential binding site is relatively novel. However, evolutionarily, such a strategy offers the advantage that a relatively large binding site on the side of V β can be masked or revealed by a single amino acid mutation. Interpretation of these experiments is ham-

pered, however, by lack of detailed knowledge about the structure of carbohydrates lying on protein faces. For example, it is not known whether carbohydrates can lie in several alternate configurations on the protein surface, nor whether they can be easily displaced by ligands binding to part of the surface they normally cover.

Choi et al. (42) have shown that the foreign superantigens, the Staphylococcal enterotoxins (SEs), bind to the same face of TCR V β as Mls-1^a. Therefore we analyzed the panel of T cell hybridomas generated for the studies in this paper for reactivity with SEs plus IA or IE. T cells bearing V β 8.2 normally respond to SEB, SEC1, SEC2, and SEC3. None of the mutations in V β described here affected responses to these toxins, with one exception. Mutation 72F \rightarrow S caused a reproducible 10-fold reduction in the response of T cells bearing it to SEC1 presented by both IA or IE, but had no effect on responsiveness to the closely related SE, SEC2 (data not shown). We were surprised that none of the residues mutated was absolutely required for interaction with the toxins. Although the interactions sites on V β for self and foreign superantigens may be overlapping it is possible that the SEs bind with higher affinity than Mls-1^a to TCR V β and several mutations may therefore be required in combination to perturb the TCR/SE interactions.

Finally, these results confirm the idea that superantigens and conventional antigens bind at nonoverlapping sites on the TCR V β (45, 46). A number of other studies have led to the same conclusion for superantigen and conventional peptide-antigen binding to class II molecules. Herman et al. (47), for example, showed that amino acid residues lying outside the presumed antigenic peptide-binding pocket of HLA-DR β chains could affect the binding and presentation of foreign superantigens, the SEs, to T cells. Likewise, Dellabona et al. (48, 49) have shown that mutations in the α -helical region of class II α chains can affect presentation of antigenic peptides, but not SEB, to T cells.

We thank Janice White and Michele Pigeon for their technical assistance, Joel Boymel and Sarah Burrell for the synthesis of oligonucleotides, and Bill Townend for assisting with the cytofluorograph analysis.

This work was supported in part by U.S. Public Health Service grants AI-18785, AI-22259, AI-26880, and AI-17134. J. Bill is the recipient of a Clinical Investigator Award (AI-00863).

Address correspondence to Ann Pullen, Howard Hughes Medical Institute, 5th Floor Goodman Building, National Jewish Center for Immunology and Respiratory Medicine, 1400 Jackson Street, Denver, CO 80206.

Received for publication 18 January 1991.

References

1. Fink, P., L. Matis, D. McElligott, M. Bookman, and S. Hedrick. 1986. Correlations between T cell specificity and structure of the antigen receptor. *Nature (Lond.)* 321:219.
2. Winoto, A., J. Urban, N. Lan, J. Goverman, L. Hood, and D. Hansburg. 1986. Predominant use of a V α gene segment in mouse T-cell receptors for cytochrome c. *Nature (Lond.)*

- 324:679.
3. Kappler, J., T. Wade, J. White, E. Kushnir, M. Blackman, J. Bill, R. Roehm, and P. Marrack. 1987. A T cell receptor V β segment that imparts reactivity to a class II major histocompatibility complex product. *Cell*. 49:263.
 4. Kappler, J.W., U. Staerz, J. White, and P.C. Marrack. 1988. Self-tolerance eliminates T cells specific for Mls-modified products of the major histocompatibility complex. *Nature (Lond.)*. 332:35.
 5. MacDonald, H.R., R. Schneider, R.K. Lees, R.C. Howe, H. Acha-Orbea, H. Festenstein, R.M. Zinkernagel, and H. Hengartner. 1988. T-cell receptor V β use predicts reactivity and tolerance to Mls^a-encoded antigens. *Nature (Lond.)*. 332:40.
 6. Pullen, A.M., P. Marrack, and J.W. Kappler. 1988. The T cell repertoire is heavily influenced by tolerance to polymorphic self antigens. *Nature (Lond.)*. 335:796.
 7. Woodland, D., M.P. Happ, J. Bill, and E. Palmer. 1989. Requirement for co-tolerogenic gene products in the clonal deletion of I-E reactive T cells. *Science (Wash. DC)*. 247:964.
 8. Bill, J., O. Kanagawa, D. Woodland, and E. Palmer. 1989. The MHC molecule I-E is necessary but not sufficient for the clonal deletion of V β 11-bearing cells. *J. Exp. Med.* 169:1405.
 9. Happ, M.P., D. Woodland, and E. Palmer. 1989. A third T cell receptor V β gene encodes reactivity to Mls-1^a gene products. *Proc. Natl. Acad. Sci. USA*. 86:6293.
 10. Marrack, P., M. Blackman, E. Kushnir, and J. Kappler. 1990. The toxicity of staphylococcal enterotoxin B in mice is mediated by T cells. *J. Exp. Med.* 171:455.
 11. Okada, C.Y., and I.L. Weissman. 1989. Relative V β transcript levels in thymus and peripheral lymphoid tissues from various mouse strains. Inverse correlation of I-E and Mls expression with relative abundance of several V β transcripts in peripheral lymphoid tissues. *J. Exp. Med.* 169:1703.
 12. Vacchio, M.S., J.J. Ryan, and R.J. Hodes. 1990. Characterization of the ligand(s) responsible for negative selection of V β 11- and V β 12-expressing T cells: effects of a new Mls determinant. *J. Exp. Med.* 172:807.
 13. White, J., A. Herman, A.M. Pullen, R. Kubo, J. Kappler, and P. Marrack. 1989. The V β -specific superantigen Staphylococcal enterotoxin B: Stimulation of mature T cells and clonal deletion in neonatal mice. *Cell*. 56:27.
 14. Janeway, Jr., C.A., J. Yagi, P. Conrad, M. Katz, S. Vroegop, and S. Buxser. 1989. T cell responses to Mls and to bacterial proteins that mimic its behavior. *Immunol. Rev.* 107:61.
 15. Takimoto, H., Y. Yoshikai, K. Kishihara, G. Matsuzaki, H. Kuga, T. Otani, and K. Nomoto. 1990. Stimulation of all T cells bearing V β 1, V β 3, V β 11, and V β 12 by staphylococcal enterotoxin A. *Eur. J. Immunol.* 20:617.
 16. Marrack, P.C., and J.W. Kappler. 1990. The staphylococcal enterotoxins and their relatives. *Science (Wash. DC)*. 248:705.
 17. Pullen, A., T. Wade, P. Marrack, and J. Kappler. 1990. Identification of the region of T cell receptor β chain that interacts with the self-superantigen Mls-1^a. *Cell*. 61:1365.
 18. Pullen, A.M., W. Potts, E.K. Wakeland, J. Kappler, and P. Marrack. 1990. Surprisingly uneven distribution of the T cell receptor V β repertoire in wild mice. *J. Exp. Med.* 171:49.
 19. Chothia, C., D.R. Boswell, and A.M. Lesk. 1988. The outline structure of the T cell $\alpha\beta$ receptor. *EMBO (Eur. Mol. Biol. Organ.) J.* 7:3745.
 20. White, J., K. Haskins, P. Marrack, and J. Kappler. 1983. Use of I region restricted, antigen specific T cell hybridomas to produce idiotypically specific anti-receptor antibodies. *J. Immunol.* 130:1033.
 21. Yagüe, J.J., J. White, C. Coleclough, J.W. Kappler, E. Palmer, and P. Marrack. 1985. T cell receptor: The α and β chains define idiotype and antigen and MHC specificity. *Cell*. 42:81.
 22. Staerz, U.D., H.G. Rammensee, J.D. Benedetto, and M.J. Bevan. 1985. Characterization of a novel monoclonal antibody specific for an allotypic determinant of T cell antigen receptor. *J. Immunol.* 134:3994.
 23. Haskins, K., C. Hannum, J. White, N. Roehm, R. Kubo, J. Kappler, and P. Marrack. 1984. The major histocompatibility complex-restricted antigen receptor on T cells. VI. An antibody to a receptor allotype. *J. Exp. Med.* 160:452.
 24. Haskins, K., R. Kubo, J. White, M. Pigeon, J. Kappler, and P. Marrack. 1983. The major histocompatibility complex-restricted antigen receptor in T cells. I. Isolation with a monoclonal antibody. *J. Exp. Med.* 157:1149.
 25. Dialynas, D., D. Wilde, P. Marrack, A. Pierres, K. Wall, W. Havran, G. Otten, M. Loken, M. Pierres, J. Kappler, and F. Fitch. 1983. Characterization of the murine antigenic determinant designated L3T4a, recognized by monoclonal antibody GK1.5: Expression of L3T4a by functional T cell clones appears to correlate primarily with Class II MHC antigen-reactivity. *Immunol. Rev.* 74:29.
 26. Kappler, J., B. Skidmore, J. White, and P. Marrack. 1981. Antigen-inducible, H-2-restricted, interleukin-2 producing T cell hybridomas. Lack of independent antigen and H-2 recognition. *J. Exp. Med.* 153:1198.
 27. Mosmann, T. 1983. Rapid colorimetric assay for cellular growth and survival: Application to proliferation and cytotoxicity assays. *J. Immunol. Methods.* 65:55.
 28. Bill, J., O. Kanagawa, J. Linten, Y. Utsunomiya, and E. Palmer. 1990. Class I and class II MHC gene products differentially affect the fate of V β 5 bearing thymocytes. *J. Mol. Cell. Immunol.* 4:269.
 29. Becker, M.L.B., R. Near, M. Mudgett-Hunter, M.N. Margolies, R.T. Kubo, J. Kaye, and S.M. Hedrick. 1989. Expression of a hybrid immunoglobulin-T cell receptor protein in transgenic mice. *Cell*. 58:911.
 30. Bill, J., V. Appel, and E. Palmer. 1988. An analysis of T cell receptor variable region gene expression in major histocompatibility complex disparate mice. *Proc. Natl. Acad. Sci. USA*. 85:9184.
 31. White, J., M. Blackman, J. Bill, J. Kappler, P. Marrack, D. Gold, and W. Born. 1989. Two better cell lines for making hybridomas expressing specific T cell receptors. *J. Immunol.* 143:1822.
 32. Kubo, R., and M. Pelanne. 1983. Tunicamycin inhibits the expression of membrane IgM in the human lymphoblastoid cell line Daudi. *Mol. Immunol.* 20:67.
 33. Koning, F., A.M. Lew, W.L. Maloy, R. Valas, and J.E. Coligan. 1988. The biosynthesis and assembly of T cell receptor α - and β -chains with the CD3 complex. *J. Immunol.* 140:3126.
 34. Laemmli, U. 1970. Cleavage of structural proteins during the assembly of the head of bacteriophage T4. *Nature (Lond.)* 227:680.
 35. Hedrick, S., E. Nielson, J. Kavaler, D. Cohen, and M. Davis. 1984. Sequence relationships between putative T cell receptor polypeptides and immunoglobulins. *Nature (Lond.)*. 308:153.
 36. Davis, M.M., and P.J. Bjorkman. 1988. T cell receptor genes and T cell recognition. *Nature (Lond.)*. 334:395.
 37. Bjorkman, P.J., M.A. Saper, B. Samraoui, W.S. Bennett, J.L. Strominger, and D.C. Wiley. 1987. Structure of the human class I histocompatibility antigen, HLA-A2. *Nature (Lond.)*. 329:512.

38. Bjorkman, P.J., M.A. Saper, B. Samraoui, W.S. Bennett, J.L. Strominger, and D.C. Wiley. 1987. The foreign antigen binding site and T cell recognition regions of class I histocompatibility antigens. *Nature (Lond.)* 329:512.
39. Brown, J.H., T. Jardetzky, M.A. Saper, B. Samraoui, P.J. Bjorkman, and D.C. Wiley. 1988. A hypothetical model of the foreign antigen binding site of class II histocompatibility molecules. *Nature (Lond.)* 332:845.
40. Marrack, P., E. Kushnir, and J.W. Kappler. 1991. A maternally inherited superantigen encoded by a mammary tumor virus. *Nature (Lond.)* 349:524.
41. Cazenave, P.A., P. Marche, E. Jouvin-Marche, D. Voegtle, F. Bonhomme, A. Bandeira, and A. Coutinho. 1990. V β 17-gene polymorphism in wild-derived mouse strains: two amino acid substitutions in the V β 17 region alter drastically T cell receptor specificity. *Cell* 63:717.
42. Choi, Y., A. Herman, D. DiGiusto, T. Wade, P. Marrack, and J. Kappler. 1990. Residues of the variable region of the T-cell-receptor β -chain that interact with *S. aureus* toxin superantigens. *Nature (Lond.)* 346:471.
43. Davies, D.R., and E.A. Padlan. 1990. Antibody-antigen complexes. *Ann. Rev. Biochem.* 59:439.
44. Wang, J., Y. Yan, T.P.J. Garrett, J. Liu, D.W. Rodgers, R.L. Garlick, G.E. Tarr, Y. Husain, E.L. Reinherz, and S.C. Harrison. 1990. Atomic structure of a fragment of human CD4 containing two immunoglobulin-like domains. *Nature (Lond.)* 348:411.
45. Fleischer, B., and H. Schrezenmeier. 1988. T cell stimulation by Staphylococcal enterotoxins. Clonally variable response and requirement for major histocompatibility complex Class II molecules on accessory or target cells. *J. Exp. Med.* 167:1697.
46. Janeway, Jr., C.A., J. Yagi, P. Conrad, M. Katz, S. Vroegop, and S. Buxser. 1989. T cell responses to Mls and to bacterial proteins that mimic its behavior. *Immunol. Rev.* 107:61.
47. Herman, A., G. Croteau, R. Sekaly, J. Kappler, and P. Marrack. 1990. HLA-DR alleles differ in their ability to present staphylococcal enterotoxins to T cells. *J. Exp. Med.* 172:709.
48. Dellabona, P., J. Peccoud, C. Benoist, and D. Mathis. 1989. T-cell recognition of superantigens: inside or outside the groove? *Cold Spring Harbor Symposia on Quantitative Biology.* 54:375.
49. Dellabona, P., J. Peccoud, J. Kappler, P. Marrack, C. Benoist, and D. Mathis. 1990. Superantigens interact with MHC class II molecules outside of the antigen groove. *Cell.* 62:1115.