

THE DISTRIBUTION OF THE ACTION CURRENTS PRO-
DUCED BY HEART MUSCLE AND OTHER EXCITABLE
TISSUES IMMERSSED IN EXTENSIVE
CONDUCTING MEDIA*

BY F. N. WILSON, A. G. MACLEOD, AND P. S. BARKER

(From the Department of Internal Medicine, University of Michigan Medical School,
Ann Arbor)

(Accepted for publication, September 20, 1932)

INTRODUCTION

In their natural environment the excitable tissues of living organisms are surrounded by a more or less extensive medium which contains electrolytes. It is necessary, therefore, in any investigation of the electrical activities exhibited by such tissues *in situ* to take into consideration the character of the laws that govern the distribution of electric currents in volume conductors.

The writings of Waller (1889) and of Einthoven and his associates (1913) indicate that these investigators were familiar with these laws and appreciated their importance. Wilson, Wishart, and Herrmann (1926) pointed out that they determine the distribution of the electric currents produced by the heart and have an important bearing upon many electrocardiographic problems. A more complete account of the observations upon which this preliminary report was based has recently been published (Wilson, 1930). Craib (1927, 1928, 1930) has shown that the electric field produced by the excitation or injury of strips of cardiac muscle, skeletal muscle, or medullated nerve immersed in an extensive conducting medium is similar to that which surrounds an electrical doublet. His observations led him to advance the view that at the moment of excitation doublets develop at the surface of or at phase boundaries within the excitable tissue. Bishop

* A preliminary report based on the material incorporated in this article appeared in *Proc. Soc. Exp. Biol. and Med.*, 1930, **27**, 588.

and Gilson (1929) have confirmed some of the observations made by Craib on skeletal muscle, but interpreted them in a different manner.

It is our purpose to apply the laws that govern the flow of electric currents in volume conductors to the analysis of certain curves obtained by leading directly from the surface of the mammalian auricle¹ and to explain our observations and those made by investigators working with other tissues in terms of the membrane theory.

Distribution of Electric Currents in Volume Conductors

The exact form of the equation that defines the distribution of an electric current flowing in a volume conductor depends upon many factors. The equations that apply in several cases of a simple kind

¹ The mammalian auricle is not essentially a more complicated structure than a curarized frog's sartorius, an isolated nerve, or a strip of cardiac muscle cut from the turtle's ventricle. It can be studied *in situ* in the uninjured state; and, unlike a nerve or a skeletal muscle, which is made up of individual fibers differing one from another in their physiological properties, it responds as a single unit. The cardiac impulse arises spontaneously at a known site, and spreads over the auricular syncytium in essentially the same way as it might spread from a point of origin over a simple protoplasmic sheet.

It may be pointed out, however, that the work of Craib (1927, 1928, 1930) shows that there is no essential difference between the distribution of the currents of action and of injury produced by strips of cardiac muscle, skeletal muscle, or nerve immersed in an extensive conducting medium and those produced by heart muscle under the conditions of our experiments. Between Craib and ourselves there is complete agreement as far as the experimental facts are concerned; in the majority of instances there is, furthermore, no important difference in opinion between us as to the interpretation that should be placed upon these facts.

In stating that work on the general subject of this article was begun in this laboratory a number of years before Craib's first paper was published (see Wilson, Wishart, and Herrmann, 1926, and Wilson, 1930) and that many of the facts to which he has called attention were known to one of us long before that paper appeared, we do not wish to raise any question of priority or in any way to claim any share of the credit due Craib for the fine work he has done. Inasmuch as our work has been done independently of his, we have naturally followed our own point of view. Craib's work has, however, made it unnecessary for us to carry out experiments upon simple tissue strips or to enter at length upon subjects that have been adequately discussed in his papers.

The interpretation which Bishop and Gilson (1929) have placed upon experimental results similar to those obtained by Craib is, in our opinion, in conflict with the laws that define the flow of electric currents in volume conductors.

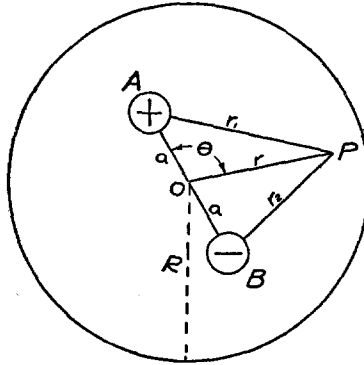

$$V = c \log_e \frac{r'}{r} \quad (1)$$

$$V = 2ac \cos \theta \quad (2)$$

$$V = 2ac \cos \theta \left(\frac{1}{r} + \frac{1}{r'} \right) \quad (3)$$

$$V = c' \left(\frac{1}{r} - \frac{1}{r'} \right) \quad (4)$$

$$V = 2ac' \frac{\cos \theta}{r^2} \quad (5)$$

$$V = 2ac' \cos \theta \left(\frac{1}{r^2} + \frac{2}{R^2} \right) \quad (6)$$

FIG. 1. Q units of positive electricity per second enter an extensive homogeneous medium through a surface of small radius at A and the same quantity leaves the conductor per second through a similar surface at B . V is the potential of any point P of the conductor. Equations (1) and (2) apply to an infinite plane lamina; equations (4) and (5) to a medium that is infinite in all directions. Equation (3) applies to a circular lamina of radius R and equation (6) to a sphere of radius R . In equations (2) and (5) it is assumed that a , one-half the distance between the source and sink, is very small in comparison with r . Equations (3) and (6) involve the additional assumption that the sink and source are equidistant from O , the center of the circular lamina or sphere. c equals $\frac{Q}{2\pi k d}$ and c' equals $\frac{Q}{4\pi k}$ where d is the thickness of the lamina and k the specific conductivity of the material of which the conductor is composed. The line AB may be called the axis of the potential difference, or of the field. For the derivation of the equations, see Pierce (1902), Mason and Weaver (1929), Canfield (1927), Jeans (1923), and Wilson (1930).

are given in Fig. 1; for our present purpose there is no advantage in dealing with more complicated conditions. Examination of these equations shows that the potential is positive at points that are nearer the source than the sink and negative at points that are closer to the latter than the former. It is zero at points equidistant from the source and sink and approaches zero at points that are at a great distance from either.

When r is very small in comparison with R , equations (5) and (6) become identical. Consequently, when the potential of a point that is very near to a source and sink that lie close together in an extensive medium is under investigation, the conductor may be considered infinite for all practical purposes. When r is equal to R the expression $\left(\frac{1}{r^2} + \frac{2r}{R^3}\right)$ in equation (6) becomes $3/r^2$; *i.e.*, at any point upon the surface of the sphere the magnitude of the potential is three times as great as it would be at the same point if the medium were infinite.

It may also be pointed out that if the volume conductor is infinite in all directions one of the two parts into which it is divided by passing a plane through the source and sink may be removed without altering the character of the electric field² (Pierce, 1902, p. 243).

The application of the equations of Fig. 1 to the analysis of curves obtained from the heart *in situ* involves some rather sweeping assumptions. The equations apply to steady currents, while the currents produced by the heart are constantly varying. It is assumed, therefore, that the effects of induction and capacity are not important. The conducting medium in which the heart is immersed is not homogeneous, as the equations require, but heterogeneous. Experience has shown, however, that the currents produced by the heart are distributed in the same general way as they would be if the heart were surrounded by an extensive homogeneous conductor. Einthoven's equilateral triangle is based on the assumption that this is the case,

² The electric currents that arise in the muscle fibers at the surface of the auricle will therefore be distributed in much the same way after the auricle is exposed by opening the chest as before. When the sink and source do not lie in the plane surface of the conducting half-space obtained by passing a plane through the infinite medium but beneath it the equation that defines the potential of points lying in this surface is of the same form as if the space were whole.

and has nevertheless been found satisfactory for all practical purposes. Nernst (1908) has shown that in such conductors as salt solutions and organic tissues the distribution of steady and of alternating currents is not materially different.

Experimental Curves

With these considerations in mind we may now turn to an experiment which, so it seems to us, is of a fundamental kind.

The curves shown in Fig. 2 A were obtained in the following way. A large dog was anesthetized with sodium amytal, the chest was opened, and the heart exposed. A non-polarizable electrode of small diameter was placed upon the surface of the right auricle midway between the upper end of the sulcus terminalis and the tip of the right auricular appendix. This electrode was attached to the right-arm terminal of the string galvanometer. The other terminal was attached to a similar electrode in contact with the subcutaneous tissues of the left hind leg.³ The galvanometer was used at one-fifth the normal sensitivity. Two other electrodes of the same kind, the first in contact with a point near the junction of the superior vena cava and right auricle and the second upon the right hind leg, were attached to the terminals of a second galvanometer so arranged that the deflections of both instruments might be recorded on the same plate. The second galvanometer was used merely for the purpose of obtaining a standard curve to which the events recorded by the first galvanometer might be related.

It will be observed that the auricular curve recorded by the first galvanometer, (upper curve of Fig. 2 A), aside from rather complicated minor details, is of relatively simple form. The gradual descent, indicating relative positivity of the exploring electrode, with which it begins, becomes steeper and steeper until a sharp inverted peak is reached. Then there is a very sudden shift to a peak similar in all respects to the first, except that it is above the base line. The succeeding descent of the curve begins with a steep slope which becomes more and more gradual until the zero position is attained.⁴

³ Hereafter we shall refer to the electrode placed on or near the heart as the exploring, proximal, or cardiac electrode; and to the electrode placed at a distance from it as the indifferent, distal, or leg electrode. In these leads the galvanometer attachments are made in such a way that relative negativity of the exploring electrode yields an upward deflection in the completed record.

⁴ These deflections correspond to the *P*-deflection of the ordinary electrocardiogram, and have approximately the same total duration if we measure from the

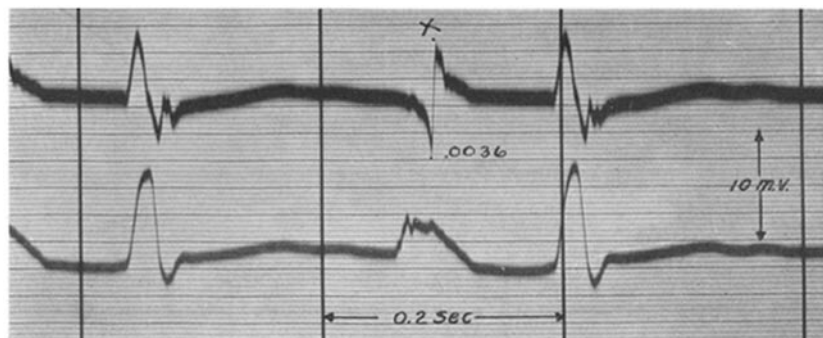

FIG. 2 A. *Upper curve*: Direct lead from a point on the surface of the right auricle of a large dog, midway between the upper end of the sulcus terminalis and the tip of the auricular appendix. An upward deflection indicates relative negativity of the exploring electrode. Indifferent electrode on left hind leg. 10 mv. equals 2 cm. Time marks indicate fifths of a second. Deflection time of the string for 10 mv. about 0.0028 second. The string was not quite aperiodic and slight overshooting was present. The "intrinsic deflection" (upward stroke) has a duration of about 0.0036 (Lucas comparator) and occurs 0.0309 after the first auricular deflection of the standard curve (lower curve).

Lower curve. Exploring electrode near junction of superior vena cava and right auricle, possibly on the vein. Indifferent electrode on right hind leg.

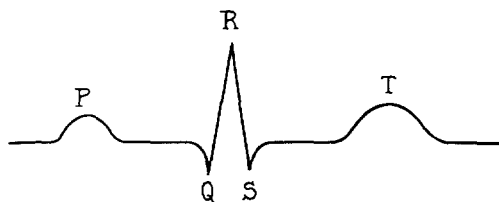

FIG. 2 B. Normal electrocardiogram

first departure from the base line to the final return. They are the result of the spread of the excitatory process over the auricular muscle. In another sense they correspond to the initial deflections of the ventricular complex as opposed to the final deflection, for they are followed by a slow deflection of the same type as the T-wave. This deflection is hidden in the particular curve under consideration by the occurrence of large deflections of ventricular origin, which occur in their proper relation to auricular systole, but is clearly seen in curves from animals in which heart-block was produced.

A curve of the same type as that described was obtained in an experiment in which, after clamping and cutting off the tip of the auricular appendix, the exploring electrode was introduced into the auricle and brought into contact with the endocardial surface of the auricular wall in the same region as in the external leads. This curve was very slightly reduced in amplitude when a thick pad of gauze soaked in Ringer's solution was placed in contact with the external surface of the auricle, and regained its original amplitude when this pad was removed.

From what has been said previously it is clear that the distal electrode placed upon the left hind leg was so far from the auricle, where all of the currents in which we are at present interested were produced, in comparison with the cardiac electrode, that its potential variations may be regarded as negligible.⁵ We may therefore regard the upper curve of Fig. 2 A as a record of the potential variations of the small region of the auricular surface upon which the proximal electrode was placed. The spread of the excitatory process from the sinus node over the auricular muscle produced at this point, if we may refer to it by that name, a gradual increase in positivity to an abrupt maximum, a sudden reversal to maximum negativity, and a final decline to zero.⁶ When curves taken at points nearer to and at points farther from the sinus node are examined it is found that the peak of maximum positivity and the succeeding peak of maximum negativity retain the same, or nearly the same, relation to each other, but alter their relation to the standard curve, coming at a progressively later time as the distance of the point investigated from the sinus node increases (Fig. 9). Obviously, the peak of maximum positivity

⁵ The elimination of the influence exerted by variations in the potential of the leg electrode upon the curve under consideration could not possibly alter any ordinate of this curve by more than two or three-tenths of a millivolt or approximately one-half of one small scale division (*cf.* Wilson, F. N., Macleod, A. G., and Barker, P. S., *Am. Heart J.*, 1931, **7**, 207).

⁶ This curve may be compared with those that Craib obtained by a similar method of leading from strips of cardiac muscle, skeletal muscle, and nerve immersed in an extensive conducting medium (1930, Plate I, Curves 5 to 10 inclusive). In making this comparison it should be borne in mind that the deflections that Craib ascribes to "doublets of retreat" are hidden in Fig. 2 A by the occurrence of ventricular deflections.

marks the onset of what Lewis and his associates (1914) have referred to as the "intrinsic deflection." As they have shown, this deflection signals the arrival of the excitation process beneath the proximal contact of a pair arranged radially with reference to the sinus node.⁷

It will be noted, however, that the potential of the exploring electrode does not actually become negative until the quick upstroke that follows the inverted peak crosses the base line. It will be convenient to regard this latter point as marking the passage of the crest of the excitation wave.

In attempting to analyze the curve under consideration we may assume, for the moment, that we are dealing with a single source and a single sink. While the first half of this curve was being written, the exploring electrode was positive and therefore nearer to the source than to the sink; during the period when the last half was written it was negative and therefore nearer to the latter than to the former. The form of the curve clearly suggests that the crest of the excitation wave is preceded by a source and followed by a sink.

Theoretical Curves

With the help of this suggestion we may attempt to derive an equation that will define a curve similar to that recorded experimentally. For the purpose of investigating the effect of a single source and a single sink moving in a straight line with a uniform velocity upon the potential of a point near which they pass, we may utilize equation (4).

The axis of the potential difference may be taken as the axis of X , and the point midway between the source and sink as origin. The potential of P , any point of the line $y = b$, may then be determined in the following way: in Fig. 3, r_2 , the distance of P from the source, equals $\sqrt{(x - a)^2 + b^2}$, and r_1 , the distance of the same point from the sink equals $\sqrt{(x + a)^2 + b^2}$. Consequently, by substitution in equation (4) we have

⁷ In the article referred to the electrode that was nearer the sinus node was called the proximal electrode; it was attached to the right-arm terminal of the string galvanometer.

$$V = c' \left(\frac{1}{\sqrt{(x - a)^2 + b^2}} - \frac{1}{\sqrt{(x + a)^2 + b^2}} \right) \tag{7}$$

The quantity b is obviously the value of r_2 when $x = a$ and the value of r_1 when $x = -a$. It represents the minimal distance between the point P and the sink or source. It is necessary to introduce this quantity in order to avoid infinite values of V when r_1 or r_2 becomes zero, and which result from the assumption that the source and sink may each be represented by a point.

The form of the curve represented by equation (7) for arbitrary values of c' , a , and b is shown in Fig. 4. It will be observed that this curve closely resembles the experimental curve described insofar as the general outline of the latter is concerned. It is obvious that when

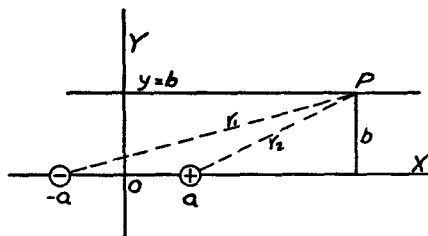

FIG. 3

$x = 0, V = 0$, and that when b is small, V is maximal for some value of x slightly greater than a and minimal for some value of x slightly less than $-a$. We have not been able to determine the maxima and minima of this curve analytically, but this can be done in the case of the corresponding curve derived from equation (5). In that case

$$V = 2 ac' \frac{x}{(x^2 + b^2)^{3/2}} \tag{8}$$

and V is maximal when $x = b/\sqrt{2}$ and minimal when $x = -b/\sqrt{2}$.

In the curves represented by both of these equations (7 and 8) the maximal and minimal values of the function depend upon b in such a way that the distance between the positive and negative peaks increases as b increases. In equation (7) this distance approaches the limit $2a$ as b approaches zero.

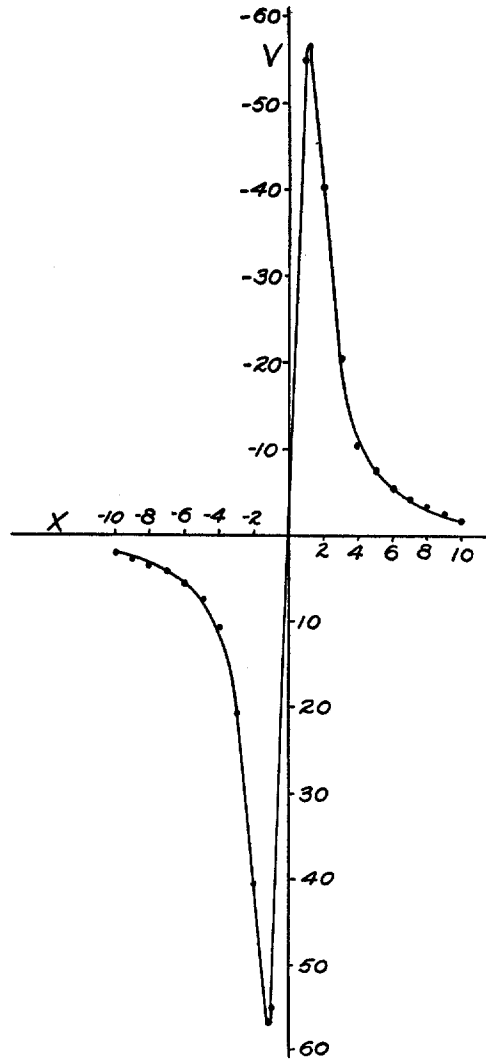

FIG. 4. Curve defined by equation (7) when $c' = 100$, $a = 1$, $b = 1$.

If we assume that the point P moves along the line $y = b$ with a uniform velocity v from a point where x has a very large positive value to a point where x has a very large negative value, or that P is stationary and the origin moves from left to right with a similar

velocity we may replace x by vt where t is the time. In that case t must be measured in the same manner as x ; *i.e.*, it must be zero when x is zero, and negative when x is negative.

The interval that separates the positive and negative peaks of the experimental curve shown in Fig. 2 A is approximately 0.0036 second. Since the velocity of the excitation wave was about 1000 mm. per second, the distance $2a$, or the distance between the source and sink, assuming that b was very small, was in the neighborhood of 3.6 mm. This distance can, of course, be determined only approximately. The exact value of b is unknown, and furthermore, we have assumed that the region upon which the electrode rests may be regarded as a point. Actually, we are not measuring the potential at a point, but the mean potential, or something approaching this, of the region mentioned. With the soft-tipped electrodes that must be used, the size and shape of this region varies with different applications of the electrode, and, because of the movements of the auricle, to some extent from instant to instant. The size of the region over which the electrode and the auricular surface are in contact must clearly influence the form of the curve.

At any given instant the potential of the point under investigation must be the same, or nearly the same, as that of every other point that bears a similar relation to the crest of the wave of excitation. It is clear, therefore, that we must be dealing not with a single source and a single sink, but with a large number of sources and sinks, the former arranged along a line parallel to the wave crest and just in front of it, the latter along a similar line just behind it. It seems reasonable to suppose that there is a source and sink within each muscle fiber along which the excitatory process is passing. In that case equation (7) may be regarded as representing the potential variations produced at a given point by the activation of a single straight muscle fiber when b is the perpendicular distance from the fiber to the given point.

The experimental curve, on the other hand, is produced by the activation of a large number of muscle fibers, and is the algebraic sum of a large number of curves of the type defined by equation (7). For each of these curves b will have a different value; it is obvious, however, that those muscle fibers that are close to the electrode, for

which the value of b is small, will have individually a much greater effect upon its potential than the fibers that are more distant.

We have attempted to modify equation (7) in such a way as to include a large number of fibers. The expression

$$V = c' \mu \log_e \left(\frac{(\sqrt{(x-a)^2 + l^2 + b^2} + l) (\sqrt{(x+a)^2 + l^2 + b^2} - l)}{(\sqrt{(x-a)^2 + l^2 + b^2} - l) (\sqrt{(x+a)^2 + l^2 + b^2} + l)} \right) \quad (9)$$

defines the potential under the conditions postulated in Fig. 5, and the accompanying legend. The curve represented by this equation is shown in Fig. 6. It will be seen that the differences between this curve and the curve derived from equation (7) are of a minor kind.

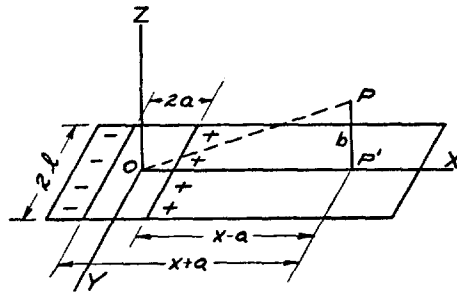

FIG. 5. The large rectangle lying in the XY plane and bisected by the X axis represents a thin sheet ($2l$ units in width) of very long parallel muscle fibers. The number of fibers, and therefore the number of sources and of sinks, per unit width of the sheet is μ . All of the fibers have been stimulated simultaneously and the crest of the excitation wave lies upon the Y axis. The distance between the sources and sinks that accompany this wave is $2a$. The exploring electrode is at the point P , of which the coordinates are x, b . The potential of the exploring electrode is given by equation (9) which is derived from equation (4). c' has the same significance in both equations.

In this case also the distance between the peak of maximum positivity and the peak of maximum negativity approaches $2a$, the distance between the source and sink produced by a single muscle fiber, as b , the distance from the electrode to the nearest muscle fiber, approaches zero.

Lewis and his associates (1914) have shown that the excitatory process, originating at the sinus node, spreads radially in all directions

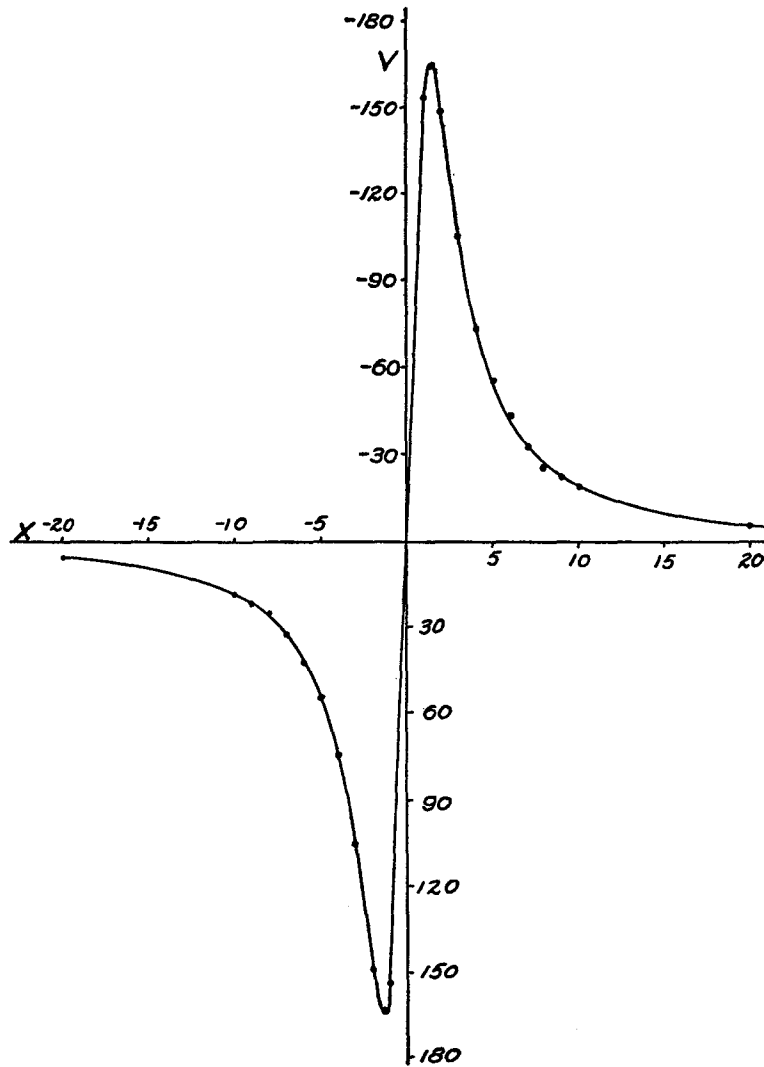

FIG. 6. Curve defined by equation (9) when $c'\mu = 100$, $a = 1$, $b = 1$, $l = 5$.

with a more or less uniform velocity. Regarding the surface of the auricle as a plane, the crest of the excitation wave must lie at any instant upon the circumference of a circle. The sources and sinks

associated with this wave would be distributed somewhat as in Fig. 7 and the potential of a point near the auricular surface would be defined by the equation

$$V = \frac{4 c' \mu (x + a)}{\sqrt{(x + a + s)^2 + b^2}} \int_0^{\pi/2} \frac{d\phi}{\sqrt{1 - k_1^2 \sin^2 \phi}} - \frac{4 c' \mu (x - a)}{\sqrt{(x - a + s)^2 + b^2}} \int_0^{\pi/2} \frac{d\phi}{\sqrt{1 - k_2^2 \sin^2 \phi}} \quad (10)$$

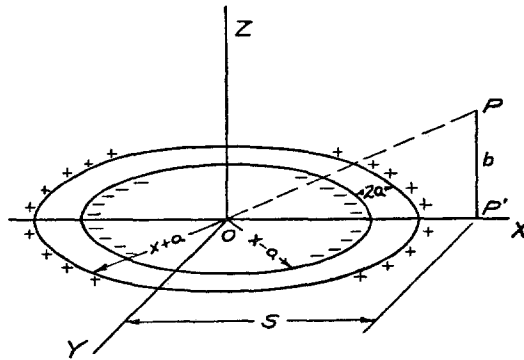

FIG. 7. The excitation wave has originated at the origin and is spreading in all directions with the same velocity through a thin sheet of muscle lying in the XY plane. The crest of this wave lies upon the circumference of a circle of radius x . The sources that precede it lie upon the circumference of a circle of radius $x + a$, and the sinks that follow it upon the circumference of a circle of radius $x - a$. The sources and sinks are equal in number and the number of the sources per unit length of arc is μ . The exploring electrode is at the point P , of which the coordinates are s, o, b . The potential of this electrode is given by equation (10). c' in this equation has the same significance as in equation (4). The two integrals are complete elliptic integrals, the values of which for known values of k may be found in suitable tables (*cf.* Pierce, 1910). The value of k_1 is $\frac{2\sqrt{(x + a)s}}{\sqrt{(x + a + s)^2 + b^2}}$ and the value of k_2 is $\frac{2\sqrt{(x - a)s}}{\sqrt{(x - a + s)^2 + b^2}}$.

Here again b , the perpendicular distance from the given point to the auricular surface is introduced to avoid infinite values of the function and the distance between the peak of maximum positivity and the

peak of maximum negativity is approximately $2a$ when b is very small.⁸

The type of curve defined by this expression is shown in Fig. 8. Unlike the curves shown in Figs. 4 and 6 it is asymmetrical. In general outline it is like the experimental curves obtained at relatively

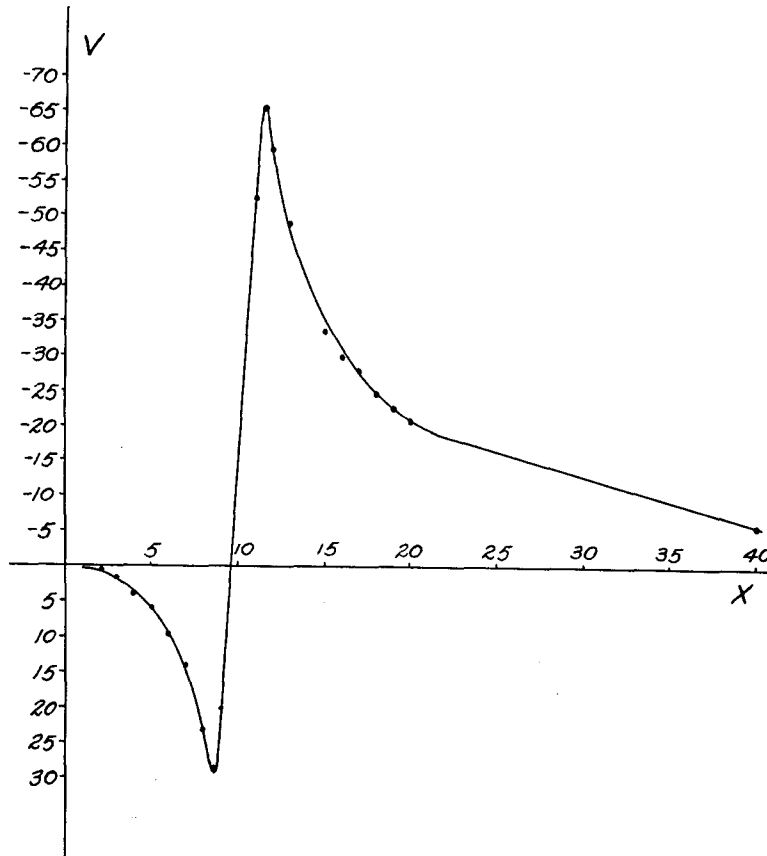

FIG. 8. Curve defined by equation (10) when $4c'\mu = 100$, $a = 1$, $b = 1$, $s = 10$

⁸ In some respects, however, this last equation differs from the previous ones. Since x is the radius of a circle (Fig. 7) it cannot have negative values; furthermore, since the radius of the circle upon which the sinks lie is $x - a$, the equation becomes meaningless when x is equal to or smaller than a .

short distances from the sinus node (Fig. 9 A). When the exploring electrode is placed immediately over the node there is, of course, no downward deflection. As the electrode is moved away from the node a small downward deflection appears and increases in amplitude until the curve becomes nearly symmetrical. When the exploring electrode is placed near the tip of the auricular appendix the peak of maximum negativity is poorly developed (Fig. 9 B). At the extreme tip of the appendix it disappears. It is probable that the asymmetry of the curves obtained near the point where the excitation wave originates

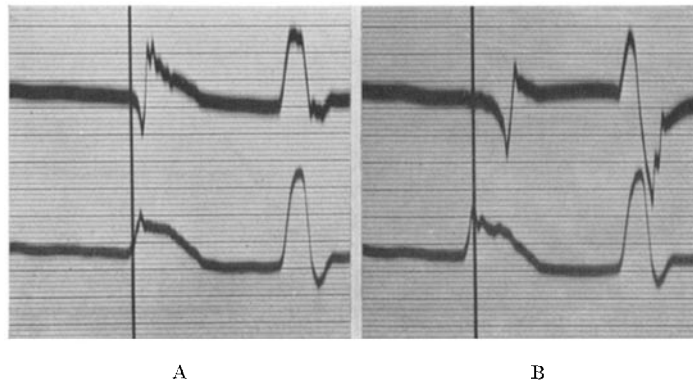

FIG. 9 A and B. Two curves from the same experiment as that shown in Fig. 2 A. The upper curves in A and B were taken in the same manner as the upper curve in Fig. 2 A, except that in A the exploring electrode was closer to the sinus node and in B it was near the tip of the auricular appendix. In A the intrinsic deflection begins 0.0125 second after the first auricular deflection in the standard lead and has a duration of 0.0046. In B the intrinsic deflection begins 0.0375 second after the first auricular deflection of the standard lead (lower curve) and has a duration of 0.0064 second.

and near the point where it is extinguished is due in part to the same circumstances that make the theoretical curve asymmetrical. When the distance of the electrode from either of these points is less than a wave length (the distance between the sources and sinks that accompany the fully developed excitation wave) the asymmetry is due chiefly to conditions that equation (10) does not take into account. For reasons that will become apparent later the sources and sinks grow in strength and separate as the excitation wave develops and

undergo the opposite changes when it is extinguished. A source of full strength cannot occur at a distance from the point of origin that is less than the full wave length; nor can a sink of full strength occur at a distance less than this from the point of extinction. Space is not available, however, for a complete discussion of this matter or of other factors that may make the experimental curve asymmetrical.

Regardless of which of the three equations is employed, the distance between the positive and negative peaks, when b is very small, is approximately $2a$, the distance between the source and sink assumed to be present within each muscle fiber along which the excitation wave is passing. It is suggested, therefore, that the interval which separates the peaks of the experimental curve obtained when a very small exploring electrode is placed in contact with the auricular surface at a point midway between the sulcus terminalis and the tip of the right auricular appendix is an approximate measure of the interval that separates the sources and sinks associated with the excitation of those fibers in close proximity to the electrode, providing that the arrangement of these fibers is not of too complex a kind and that all conduct with the same or nearly the same velocity. We may refer to this interval as the effective length of the excitation wave.

Electric Field of a Polarized Membrane

The observations described suggest that the electrical effects produced by the excitation of a single muscle fiber are the same as those that would occur if the crest of the wave of excitation were preceded by a source and followed by a sink. The same conclusion can be derived on theoretical grounds from the so called membrane theory advanced originally by Bernstein which is too well known to require exposition here. We need merely say that according to this hypothesis each element of a resting muscle fiber is surrounded by a semi-permeable membrane and is in consequence the seat of a double layer of ions, a layer of cations, to which the membrane is permeable, on its outer surface and a layer of anions, to which the membrane is impermeable, on its inner surface.

Under these circumstances physiologists are accustomed to speak of the membrane as polarized (Bayliss, 1918, pp. 649-650). It is held that when a muscle element passes from the resting to the active

state the membrane bounding it becomes permeable to the anions as well as to the cations and is depolarized; when it returns to the resting state it is repolarized.

Since the membrane is supposed to be very thin and since the cations on its outer surface are positively and the anions on its inner surface negatively charged, a polarized membrane is equivalent electrically to a thin polarized shell. The potential V at any point P of an infinite homogeneous medium⁹ within which such a membrane is immersed is determined by the expression

$$V = \phi \omega \quad (11)^{10}$$

where ϕ is a constant,¹¹ which may be defined as the electrical moment of a membrane of unit area, and ω is the solid angle subtended by the membrane at P ; *i.e.*, ω is the area cut out upon a spherical surface of unit radius inscribed about P by the cone formed by drawing lines from P to every point upon the boundary of the membrane. When an observer who is stationed at P and is looking through this cone sees the positive side of the membrane, V is positive; when he sees the negative side of the membrane, V is negative. It is convenient to consider the solid angle that determines V to have the same sign.

By the boundary of the membrane is meant an edge at which it terminates. In this sense a tennis ball has no boundary but if it be cut in two parts (equal or unequal) each portion has a boundary which is the cut edge. When a part of the membrane is depolarized the boundary is the line which separates the polarized from the depolarized part.

The solid angle subtended by the completely closed polarized shell or membrane that surrounds a resting cell (Fig. 10) at any point outside the cell (P_0) is zero (Pierce, 1902, p. 215). Consequently, the potential at all points outside a resting muscle fiber immersed in an infinite homogeneous conductor would be zero. The solid angle

⁹ The assumption that the medium, instead of being infinite, is a sphere of large radius does not materially alter the character of the electric field.

¹⁰ Cf. Pierce, 1902, 215.

¹¹ Equation (11) is derived from equation (5) of Fig. 1. ϕ equals $2ac'\mu$, where a and c have the same significance as in that equation and μ is the number of sinks or negative charges on the inner and the number of sources or positive charges on the outer surface of the shell or membrane per unit area.

subtended at any inside point (P_I) is 4π hence the potential at all points inside the fiber would be $4\pi\phi$ and would be negative since the negative charges are on the inner surface of the polarized membrane. In passing across the membrane from an outside to an inside point there would be a sudden drop in potential amounting to $4\pi\phi$; a discontinuity of the potential function similar to that which occurs in an electric cell. So long as the polarization of the membrane remained unaltered, the drop in potential across it would be the same whether it formed an open or a closed surface (Pierce, 1902, p. 215), *i.e.*, if

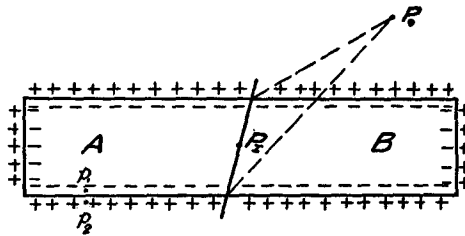

FIG. 10. The diagram represents a cylindrical cell surrounded by a polarized membrane and immersed in an infinite conducting medium. P_o is any point external to the cell and P_I any point inside the cell. A plane (represented by a line) through P_I divides the closed membrane that surrounds the cell into two parts A and B , each of which may be considered alone as if the other were not present. The solid angle subtended at P_o by A , that portion of the membrane lying to the left of the dividing plane, is defined as the area cut out upon a spherical surface of unit radius inscribed about P_o as center by a certain cone. This cone is formed by drawing lines (indicated by broken lines) from P_o to every point upon the boundary of A . When an observer stationed at P_o looks through this cone he sees the negative side of the membrane A , and the solid angle subtended by this membrane at P_o is therefore negative. The boundary of B is the same as the boundary of A (the boundary of each membrane being the edge that abuts upon the plane through P_I), and the solid angle subtended by B at P_o is equal to that subtended by A at the same point in absolute magnitude. Since an observer who is looking through the specified cone sees the positive side of B , the solid angle subtended at P_o by this membrane is positive. Consequently, the solid angle subtended at P_o by A and B together is zero. The solid angle subtended at P_I and that subtended by B at the same point are each equal to 2π , and both are negative. The lines drawn from P_I to the boundary of A and B lie in the plane passed through this point. This plane may be considered a cone whose vertex is at P and whose solid angle is 2π .

p_1 and p_2 are two points very close together, one on either side of the membrane A .

p_1 and p_2 (Fig. 10) are two points very close together, but on opposite sides of a completely closed and uniformly polarized membrane the difference in potential between them ($4\pi\phi$) will not be altered by removing or depolarizing a distant portion of the membrane so long as the charges upon that portion of the membrane that lies between and adjacent to them are not disturbed.

The maximal electromotive force across a semipermeable membrane polarized in the manner specified is given (Donnan, 1924-25) by the equation

$$E = \frac{RT}{nF} \log_e \frac{c_1}{c_2} \quad (12)^{12}$$

where R is the gas constant expressed in electrical units; T , the absolute temperature; F , the Faraday equivalent; n , the valency of the diffusible cation; and c_1/c_2 the ratio of the concentration of this cation on one side of the membrane to its concentration on the other. Consequently,

$$\phi = \frac{RT}{4 \pi nF} \log_e \frac{c_1}{c_2} \quad (13)$$

Inasmuch as the solid angle subtended by a polarized membrane is not determined by the configuration of the membrane but solely by its boundaries, the electrical fields produced in an infinite medium by two membranes, polarized in the same sense and to the same intensity, which have the same boundaries must be identical. In Fig. 11 the polarized disk A and the polarized membrane B , a cylindrical shell open at one end, taken together form a completely closed surface. The potential at P , any point outside this surface, due to A and B taken together is therefore zero. We may regard this potential as the sum of two potentials, V_A , the potential at P due to A alone, and

¹² This is the Nernst equation for a concentration cell. It has been found that the electromotive force is determined by the ratio of the activities of the ion (Lewis and Randall, 1923) rather than by the ratio of its concentrations. In dilute solutions these two ratios do not differ materially. This equation is introduced here to show that the constant ϕ has the dimensions of an electromotive force, and to indicate the nature of the factors that may determine its value. Whether this equation, which is reasonably accurate in the case of non-living systems, can be applied to living cells is for the purpose of this article immaterial.

$-V_B$, the potential at P due to B alone. We have then $V_A + (-V_B) = 0$; consequently V_A and V_B are equal in magnitude. If we reverse the charges on A , as in Fig. 11, b , the solid angles subtended by A and B at P which are equal in magnitude will have the same sign and the former may be substituted for the latter in computing

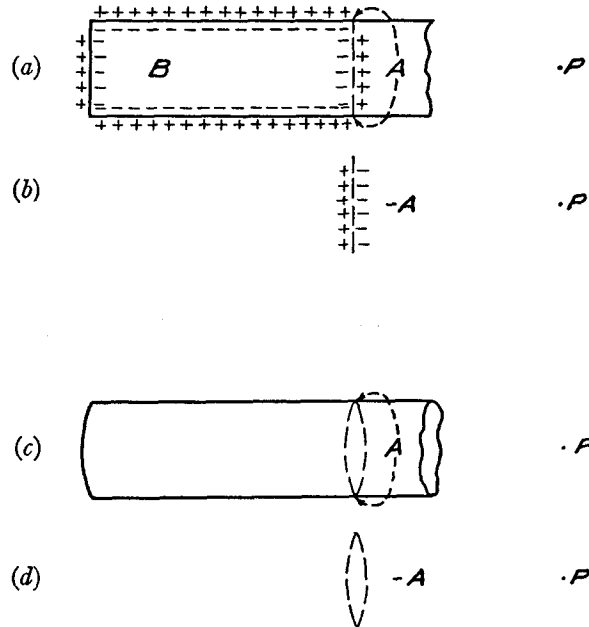

FIG. 11. The diagram a represents a cylindrical cell, surrounded by a membrane which is represented by a continuous line. That portion of the membrane that is represented as extending for an indefinite distance to the right of the broken line A has been completely depolarized. The remainder of the membrane, labelled B , is still polarized. The transition from the depolarized to the polarized portion of the membrane is represented as abrupt. P is any point outside the cell. In order to compute the effect of the polarized membrane B upon the potential at P we imagine a polarized disk A , indicated by a broken line, placed at the junction of the polarized and depolarized portions of the cell; A and B together will then form a closed polarized surface, and the potential at P due to A and B together must be zero. The effect of the polarized membrane B upon the potential at P must, therefore, be the same as the effect produced by the polarized disk A with the polarity of the charges reversed as in diagram b . This is merely a mathematical method of obtaining a convenient resultant of the charges upon the membrane B . In this sense and in this sense only $-A$ may be substituted for B .

the potential of points external to the closed surface which they form when taken together.

It is clear that if the excitation of a muscle fiber consisted in the instantaneous and complete depolarization of the membrane bounding successive elements of the fiber, so that an abrupt transition occurred at the junction of the polarized and depolarized portions of the membrane, the electric field at outside points due to the charges upon the former and the electric field that would be produced by the charges upon a polarized disk located at this junction would be identical. The disk must be polarized to the same intensity as the membrane of the resting fiber and the negative side of the disk must face toward the active muscle. Under these circumstances a polarized disk traveling along the fiber would give all of the electrical effects associated

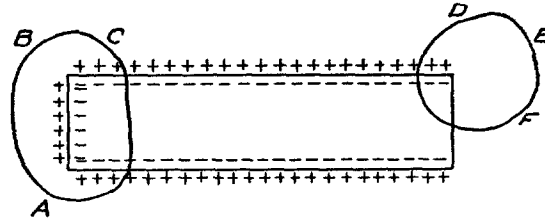

FIG. 12. The diagram represents a cylindrical cell surrounded by a polarized membrane except that the disk of membrane that closes one end of the cylinder has been completely depolarized. *ABC* is any circuit that does not pass and *DEF* any circuit that does pass through the depolarized portion of the membrane.

with the wave of excitation and at any instant the electric field would be such as might be produced by polarization of the surface separating the active from the resting muscle.

In so far as these conclusions are concerned the extent of the conducting medium in which the muscle is immersed is immaterial. The electromotive force across the membrane must be the same whether the medium is limited or infinite; it is defined by equation (12) into which the extent of the medium does not enter. Imagine that it were possible to completely depolarize the membrane at one end of a muscle fiber without altering the other charges (Fig. 12). Let *ABC* represent any possible circuit in the medium that does not pass through the depolarized portion of the membrane. If this circuit cuts the polarized membrane it must do so an even number of times and the sum of

all the potential discontinuities that it contains must be zero. *DEF* represents any circuit that passes through the depolarized membrane at the end of the fiber and crosses the polarized membrane an odd number of times. The sum of the potential discontinuities in this circuit must be $4\pi\phi$. If the depolarized portion of the membrane is now repolarized no current will flow in any circuit. It is a general principle that if in any circuit or in any network, containing any number of batteries, the addition of another battery reduces the currents flowing to zero, the currents in all circuits will be the same as they were originally if the polarity of the last battery is reversed and all others are removed.¹³ Whatever the extent of the medium in which the fiber is immersed, the electric field of the partially depolar-

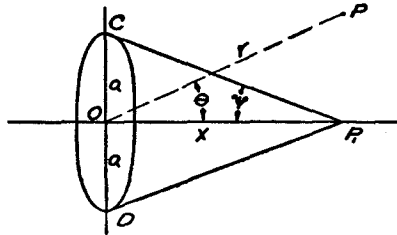

FIG. 13. *CD* is a disk of radius *a*, whose center is at *O*. *P*₁ is any point on the axis of this disk, *P* any point not on the axis.

ized fiber must, therefore, be equivalent to that of the circular disk of polarized membrane polarized in a sense opposite to that required to reduce the current in all circuits to zero.

The potential at any point in an infinite homogeneous medium in which a polarized disk is immersed is determined by the solid angle subtended by the disk at that point. In Fig. 13 the magnitude of the

¹³ It is, of course, required that these procedures shall not alter the resistances of the circuits involved. In applying this principle of substitution to the partially depolarized muscle fiber, it should be remembered that any peculiarities of resistance must not be changed. If the membrane, the interior of the cell, and the medium differ in conductivity the polarized disk that is substituted for the charges distributed over the partially depolarized fiber will not be immersed in a homogeneous medium; the resistance after substitution *must* be the same as before.

solid angle subtended by the disk CD at a point on its axis (P_1) is defined by the equation

$$\omega = 2\pi (1 - \cos \psi) \quad (14)$$

In order to define the magnitude of the solid angle subtended at a point not on the axis an infinite series is required.¹⁴ If the radius of the disk is small, that of a muscle fiber, the solid angle subtended by it at any relatively distant point P is, however, very nearly equal to $\frac{S \cos \theta}{r^2}$ where S is the area of the disk and r and θ have the significance indicated in Fig. 13. If the disk is polarized the potential at P will be defined approximately by the equation

$$V = \phi S \frac{\cos \theta}{r^2} \quad (15)$$

This expression is identical with that which defines the potential at any point due to a single source and a single sink lying very close together upon the axis of the disk and equidistant from its center. The strength of this doublet is proportional to the product of the area of the disk and the intensity to which it is polarized. The magnitude of the electric currents produced at a given instant by a partially depolarized muscle fiber should likewise be proportional to the product of its cross-sectional area and the intensity of its polarization.

Gradual Depolarization

In the foregoing discussion it has been assumed for the sake of simplicity that the activation of a muscle fiber is accompanied by complete and instantaneous depolarization of each successive portion

¹⁴ If the disk CD were polarized the potential at any point P (Fig. 13) would be exactly defined by the series

$$V = \phi S \frac{\cos \theta}{r^2} - \phi \pi \left[\frac{1.3}{4} \frac{a^4}{r^4} P_3(\cos \theta) - \frac{1.3.5}{4.6} \frac{a^6}{r^6} P_5(\cos \theta) \dots \text{etc.} \right]$$

in this expression S is this area of the disk and $P_m(\cos \theta)$ is the appropriate coefficient of Legendre. This series is convergent if the ratio of a to r is less than 1. It will be noted that equation (15) may be derived from this series by dropping all terms except the first.

of the fiber. So long as all portions of the fiber are depolarized to the same extent it will not matter whether depolarization is complete or incomplete. Obviously, instantaneous depolarization is impossible, and we must therefore attempt to determine to what extent the effects produced by gradual depolarization will differ from those that would occur if depolarization occurred instantaneously.

If the number of charges per unit surface in the resting fiber is μ the distribution of the charges may be considered equivalent to N distributions of density $\frac{\mu}{N}$; *i.e.*, we may conceive of the total charge

as made up of $\frac{\mu}{N}$ layers of infinitesimal thickness, each layer containing

$\frac{\mu}{N}$ charges per unit surface. Suppose that depolarization of the fiber begins at one end; that complete depolarization has taken place to the right of A in Fig. 14; and that between A and B partial depolarization has taken place, so that the number of charges per unit surface increases progressively from A to B where the intensity of polarization becomes that of the resting fiber. Let that portion of the cylindrical fiber which lies between A and B be divided into $N - 1$ zones by means of N thin laminae perpendicular to the axis of the cylinder. The first of these laminae will pass through A , the N th through B . Suppose that N is a very large number and consequently that the zones are so narrow that the number of charges per unit surface within any zone is constant; the number of charges per unit surface will then be $\frac{\mu}{N}$ over the first zone, $2\frac{\mu}{N}$ over the second zone, $3\frac{\mu}{N}$ over the third, and so forth, reaching a value of $\frac{\mu(N - 1)}{N}$ in zone $N - 1$. If

the circular disk cut out of each lamina by the curved surface of the cylinder is polarized to density $\frac{\mu}{N}$, the positive charges being toward the depolarized end of the muscle, the distribution will be equivalent to N completely closed surfaces over each of which the polarization density is $\frac{\mu}{N}$ and the potential at any point outside the cylinder due to this distribution will be zero. Consequently, the potential at any point

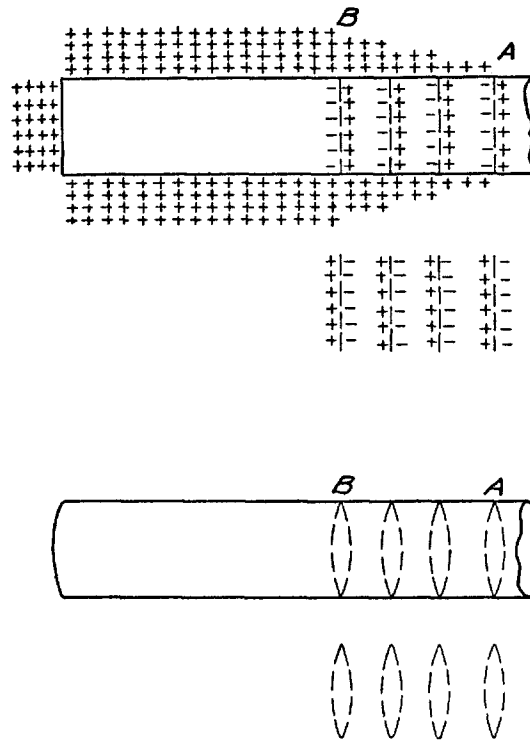

FIG. 14. The diagram represents a cylindrical cell surrounded by a membrane (indicated by a continuous line). This membrane is uniformly polarized to the left of *B* (to avoid confusion only the positive charges are indicated) and completely depolarized to the right of *A*. Between *B* and *A* the intensity of polarization declines by successive steps to zero. In order to determine the effect of this polarized membrane upon the potential of any point outside the cell we imagine a number of polarized disks (indicated by broken lines) located between *A* and *B*. Each disk is placed at a point where a drop in the intensity of polarization occurs and forms with the layer of sources and sinks (only the former are shown) that does not extend to the right of it a completely closed and uniformly polarized surface. The potential at any point outside the cell due to the polarized membrane and the polarized disks taken together will therefore be zero. Consequently the polarized membrane will have the same effect upon the potential at an outside point as would be produced by the disks if the polarity of their charges were reversed as indicated. In this sense the polarized disks may be substituted for the polarized membrane in computing the electric field outside (but not inside) the cell.

outside the cell due to the charges distributed over the partially depolarized muscle fiber will be the same as the potential at the same point due to the N polarized disks lying between A and B with the polarity of the charges reversed as indicated in Fig. 14. Since there are N disks distributed over the distance AB which we may call L , the mean number of disks per unit length within the interval AB is $\frac{N}{L}$. Providing that the number of disks per unit length is the same for all parts of AB , the potential at P due to all of the disks will be defined by the expression

$$V = \frac{\phi S}{L} \left(\frac{1}{PB} - \frac{1}{PA} \right) \quad (16)$$

Consequently, the potential at P , any point outside the cell, is equivalent to that produced by a single source at B and a single sink at A ; that is to say, a source at the point where the depolarization is just beginning and a sink at the point where it has just become complete. The potential of an electrode placed very close to the muscle fiber will reach its maximum positivity at the moment when depolarization of the subjacent membrane begins, and its maximum negativity at the moment when depolarization of the subjacent membrane is complete.

If the distance AB is small in comparison with the distance of P from the fiber the above equation becomes

$$V = \frac{\phi S}{L} \left(\frac{L \cos \theta}{r^2} \right) = \phi S \frac{\cos \theta}{r^2}$$

and if this equation is compared with equation (15) it will be seen that the potential of an electrode distant from the fiber will be the same as it would be if depolarization of each successive element of the fiber took place instantaneously.

In the above discussion it has been assumed that the rate of depolarization is constant; in other words, that after depolarization of any given portion of the membrane begins, it proceeds at a uniform rate until complete. It is very improbable, however, that depolarization takes place in that way. Suppose that it proceeds very slowly at first, then with increasing rapidity until its rate is maximal, and finally

with diminishing speed until it is complete. The mean number of polarized disks, or sources and sinks, per unit length within the interval AB will still be $\frac{N}{L}$; but the number of disks in any given subdivision ΔL of this interval will vary with the position of ΔL within the interval. If ΔL is near the beginning or end of the interval the number of sources and sinks will be small; if it is near the middle of the interval the number will be large. The distribution of sources and sinks will be similar to that shown in Fig. 15 in which each square represents a source and sink, or a polarized disk. In this curve the ordinate at any given point represents merely the number of sources and sinks per unit length of the interval AB at the corresponding point within the interval; all of the sources and sinks are supposed to lie upon the line AB . Each horizontal row of squares may be represented by a single source and a single sink as indicated in the figure. For the

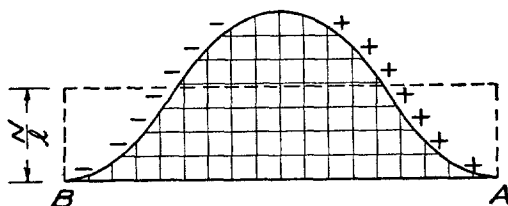

FIG. 15. At a given instant the membrane that surrounds a cylindrical cell is uniformly polarized to the right of A and completely depolarized to the left of B . Between A and B it is partially depolarized. The rate at which the intensity of polarization is changing at any point between A and B is proportional to the length of the ordinate that passes through that point. For the purpose of determining the potential at any point outside the cell we may substitute for the positive and negative charges that remain upon the polarized and partially depolarized portions of the membrane a certain distribution of charges obtained by placing within each element of the interval AB the number of polarized disks indicated by the ordinate of the curve passing through that element. These polarized disks, each of which is approximately equivalent to a source and sink very close together (a doublet) are indicated by small squares. They are proportional in number to the area under the curve. For these disks we may in turn substitute the sources and sinks indicated by appropriate signs, all of which are supposed to lie upon the line AB . If l represents the length of the line AB and N the total number of polarized disks, the mean number of disks per unit length of AB will be $\frac{N}{l}$ and the area under the curve will be equal to that of the rectangle indicated.

lowest row of squares the source will be at A and the sink at B . For the other rows the source and sink will be closer together and both will lie between A and B . Inspection of the figure shows that the concentration of sources will be greatest at the point where the rate of depolarization is increasing most rapidly, and that the greatest concentration of sinks will occur at the point where the rate of depolarization is decreasing most rapidly. We may therefore expect that if this distribution of sources and sinks passes along a muscle fiber with a uniform velocity, an electrode placed close to the fiber will display maximum positivity approximately at the time when the rate of depolarization of the membrane beneath it is increasing most rapidly, and maximum negativity at the time, approximately, when the rate of depolarization of the membrane beneath it is decreasing most rapidly.¹⁵ The distance between the peak of maximum positivity and the peak of maximum negativity in such curves as that shown in Fig. 2 A must depend upon the form of the curve that represents the rate of depolarization at a given point.

The total number of sources and sinks within the distribution is represented by the area under the curve (Fig. 15), which is equivalent to the area of the rectangle of which AB forms one side and $\frac{N}{L}$, the mean number of sources and sinks per unit length of AB , the other. At points distant from the muscle in comparison with the length AB the electrical effects will be the same whatever the distribution of sources and sinks within the interval AB . Consequently, it will be immaterial whether the rate of depolarization is constant or variable, or whether depolarization at a point takes place gradually or instantaneously.

Repolarization

When the period of activity comes to an end, and the muscle fiber is restored to the resting state, repolarization of the membrane is assumed to take place. If the order of repolarization is the same as the order of depolarization the electrical effects produced by it must

¹⁵ This conclusion holds only in case the curve that represents the rate of depolarization belongs to a certain class.

be opposite in polarity to those produced by depolarization. With this exception all of the statements made with respect to depolarization apply with equal force to repolarization. The form of the curve that represents the potential variations produced by the repolarization of a single muscle fiber at a point near the fiber will depend upon the distance AB , where A is the point at which repolarization is just beginning and B the point at which it has just become complete; upon the form of the curve that represents the rate of repolarization at any given point; and upon the velocity of the wave of repolarization along the muscle fiber. At points distant from the fiber in comparison with the length AB the potential at any instant will be the same as if repolarization at any given point took place instantaneously.¹⁶ It is clear that if the order of repolarization is the same as the order of depolarization the total electrical effect produced by the one process must be equal in magnitude but opposite in sign to that produced by the other. In other words, the total quantity of electricity flowing through any given circuit must be the same in both cases.

We should expect the curve shown in Fig. 2 A to be followed by a curve of similar form in which the positions of the positive and negative phases were reversed. This portion of the curve, however, is hidden by the occurrence of ventricular deflections. Although we have performed a few experiments in which the production of complete heart block prevented interference of this kind, we are not as yet in a position to offer a satisfactory analysis of the electrical effects produced at points upon the auricular surface by repolarization of the auricular muscle. It is obvious, however, that repolarization takes place very slowly in comparison with depolarization and that the former is modified by a great many factors that have little or no effect upon the latter. Consequently, the number of fibers or units producing electric forces simultaneously is much greater in the case of repolarization than in the case of depolarization and the order of the two processes is not necessarily the same.

¹⁶ This statement does not apply during the period when the recovery wave is developing or being extinguished; nor does the similar statement made with reference to depolarization apply when the excitation wave is developing or being extinguished.

Comments

In the preceding pages we have described briefly certain curves obtained by leading directly from the mammalian auricle, and have attempted to analyze these curves by applying the principles that govern the distribution of electric currents in volume conductors. Our analysis involves certain simplifying assumptions that are not strictly in accord with the facts. The equations and conclusions based upon these assumptions are, therefore, to be regarded as approximations only.

We have attempted to develop a mathematical theory that would explain the observations relating to the distribution of the action currents produced by excitable tissues immersed in or in contact with a large body of conducting material made by ourselves and by others. We have employed the language of the so called membrane theory and have founded the mathematical treatment of our problem upon its postulates. It should be pointed out, however, that the distribution of the electric currents under consideration must be essentially the same regardless of the manner of their origin.

Perhaps this statement should be amplified by a few words of explanation. From the mathematical standpoint an electromotive force existing at a boundary may be represented by a polarized surface. If there is a difference of potential between the interior and the exterior of a resting cell and this difference of potential decreases or disappears when the cell is activated, the electric field will be the same whatever the mechanisms involved may be.

Where the electromotive force does not arise at a single boundary, but within a transitional zone which may be considered an infinite succession of boundaries, each marking an infinitesimal physico-chemical change, the matter within this zone may be regarded as electrically polarized. The essential characteristic of the theory presented is that it defines the electric field about a muscle fiber undergoing activation as equivalent to that which would be produced by polarization of those portions of the fiber that are passing from the resting to the active state or *vice versa*. It is required that the effective electric forces shall be confined, or shall appear to be confined, within these regions; the mechanism of their production is immaterial. It is clear, so it seems to us, that this requirement must be met by

any hypothesis that seeks to explain the origin of the action current. The polarity of the electric forces associated with excitation and of those that accompany recovery is determined by the relative positions of the active and resting portions of the muscle fiber. This is a plain indication that no unbalanced electric forces exist except as a consequence of the presence of zones within which excitation or recovery is in progress. These are the only portions of the fiber, so it would seem, within which there is a gradient that can determine polarity. A muscle fiber in the resting state or in the same state of activity throughout its length can hardly produce an electric current when it is completely surrounded by a homogeneous medium. In either case the boundaries that define the different phases responsible for the heterogeneous character of the tissue are completely closed, and any electric forces that exist at these boundaries must be in equilibrium. There is nothing in the situation to distinguish one end of the fiber from the other; no unbalanced polarity that can become evident external to the tissue.

The membrane theory has the important advantage that it explains the current of action and the current of injury on the same basis. According to its postulates the effective electric forces responsible for the current that accompanies excitation do not actually arise within the transitional zones referred to, but only appear to do so because of the disturbance within these regions of a previously existing equilibrium.

It must be borne in mind that in writing the equations that define an electric field it has been assumed that the electric conductivity is uniform throughout all space, *i.e.*, that the medium, the membrane, and the interior of the cell have the same conductivity, and also that the conductivity of the membrane is not altered by depolarization. It is improbable that there is any tissue that meets these requirements, and these equations cannot be expected to be exact in a quantitative sense. In the case of cardiac muscle they appear to represent actual conditions with sufficient accuracy to be useful, and it seems probable that they will hold reasonably well for skeletal muscle and possibly nerve.

The equations mentioned are also based upon the assumption that the medium is infinite. The distribution of the action current will,

however, be the same in all essential particulars, if the excitable tissue is deeply embedded in any extensive medium.

SUMMARY

The action currents produced by heart muscle and other tissues immersed in or in contact with a large body of conducting material are distributed in accordance with the laws that govern the flow of electric currents in volume conductors.

The curve obtained when one electrode (the exploring electrode) is placed very close to and the other (the indifferent electrode) very far from the active tissue may be regarded as representing the potential variations of the exploring electrode alone; the potential of the indifferent electrode is by comparison nearly constant.

Curves obtained by this method of leading from the surface of the mammalian auricle indicate that the electrical effects produced by the passage of the excitation wave along a single muscle fiber are nearly the same as those that would occur if the crest of this wave were immediately preceded by a source and followed by a sink.

A study of the electric field of a polarized membrane immersed in a volume conductor shows that this conclusion may be derived on theoretical grounds from the membrane theory of Bernstein.

We wish to thank Dr. H. B. Williams and Dr. Kenneth Cole for a careful and critical reading of the first draft of this article with particular reference to the mathematical processes and the physical and physiological principles involved, and also for the valuable suggestions that they have given us.

REFERENCES

1. Bayliss, W. M., 1918, Principles of general physiology, London, Longmans, Green & Company, 2nd edition.
2. Bishop, G. H., and Gilson, A. S., 1929, Action potentials from skeletal muscle, *Am. J. Physiol.*, **89**, 135.
3. Canfield, R., 1927, On the electrical field surrounding doublets and its significance from the standpoint of Einthoven's equations, *Heart*, **14**, 102.
4. Craib, W. H., 1927, A study of the electrical field surrounding active heart muscle, *Heart*, **14**, 71.
5. Craib, W. H., 1928, A study of the electrical field surrounding skeletal muscle, *J. Physiol.*, **66**, 49.

6. Craib, W. H., 1930, The electrocardiogram, *Great Britain Med. Research Council, Special Rep. Series, No. 147*.
7. Donnan, F. G., 1924-25, The theory of membrane equilibria, *Chem. Rev.*, **1**, 73.
8. Einthoven, W., Fahr, G., and de Waart, A., 1913, Über die Richtung and die manifeste Grösse der Potentialschwankungen im menschlichen Herzen und über den Einfluss der Herzlage auf die Form des Elektrokardiograms, *Arch. ges. Physiol.*, **150**, 275.
9. Jeans, J. H., 1923, The mathematical theory of electricity and magnetism, Cambridge, Cambridge University Press, 4th edition.
10. Lewis, T., Meakins, J., and White, P. D., 1914, The excitatory process in the dog's heart. Part I. The auricles, *Phil. Tr. Roy. Soc., London, Series B*, **205**, 322.
11. Lewis, G. N., and Randall, M., 1923, Thermodynamics and the free energy of chemical substances, New York, McGraw-Hill Book Company.
12. Mason, M., and Weaver, W., 1929, The electromagnetic field, Chicago, The University of Chicago Press.
13. Nernst, W., 1908, Zur Theorie des Elektrischen Reizes, *Arch. ges. Physiol.*, **122**, 275.
14. Pierce, B. O., 1902, Elements of the theory of the Newtonian potential function, Boston, Ginn & Co., 3rd edition.
15. Pierce, B. O., 1910, A short table of integrals, Boston, Ginn & Co., 2nd edition.
16. Waller, A., 1889, On the electromotive changes connected with the beat of the mammalian heart, and of the human heart in particular, *Phil. Tr. Roy. Soc. London, Series B*, **180**, 169.
17. Wilson, F. N., 1930, The distribution of the potential differences produced by the heart beat within the body and at its surface, *Am. Heart J.*, **5**, 599.
18. Wilson, F. N., Wishart, S. W., and Herrmann, G. R., 1926, Factors influencing the distribution of potential differences, produced by the heart-beat at the surface of the body, *Proc. Soc. Exp. Biol. and Med.*, **23**, 276.