

ENERGY, QUANTA, AND VISION*

BY SELIG HECHT, SIMON SHLAER, AND MAURICE HENRI PIRENNE‡

(From the Laboratory of Biophysics, Columbia University, New York)

(Received for publication, March 30, 1942)

I

Threshold Energies for Vision

The minimum energy required to produce a visual effect achieves its significance by virtue of the quantum nature of light. Like all radiation, light is emitted and absorbed in discrete units or quanta, whose energy content is equal to its frequency ν multiplied by Planck's constant h . At the threshold of vision these quanta are used for the photodecomposition of visual purple, and in conformity with Einstein's equivalence law each absorbed quantum transforms one molecule of visual purple (Dartnall, Goodeve, and Lythgoe, 1938). Since even the earliest measurements show that only a small number of quanta is required for a threshold stimulus, it follows that only a small number of primary molecular transformations is enough to supply the initial impetus for a visual act. The precise number of these molecular changes becomes of obvious importance in understanding the visual receptor process, and it is this which has led us to the present investigation.

The first measurements of the energy at the visual threshold were made by Langley (1889) with the bolometer he invented for such purposes (Langley, 1881). He found the energy to be 3×10^{-9} ergs for light of 550 $m\mu$. Langley worked before the physiology of vision was understood, so that he used the wrong light and took none of the precautions now known to be necessary; even so, his results are too high only by a factor of 10.

In the fifty years since Langley there have been eleven efforts to redetermine the minimum energy for vision. We have carefully studied all these accounts and have done our best to evaluate the measurements. Unfortunately, many of them contain serious errors which invalidate them. Most of them involved no direct energy determinations; instead, the investigators relied on previously measured energy distributions in standard sources and made elaborate computations from them. Only a few can be considered as reliable.

After Langley, the earliest paper is by Grijns and Noyons (1905). Their data differ widely from all other measurements and cannot be accepted even

* A preliminary report of these measurements was published in *Science* (Hecht, Shlaer, and Pirenne, 1941), and presented to the Optical Society in October, 1941 (Hecht, 1942).

‡ Fellow of the Belgian American Educational Foundation.

though it is hard to discover their precise errors because the description is too obscure. Zwaardemaker (1905), in whose laboratory their measurements were made, reports some of his own rough determinations, which turn out to be near Langley's. Neither Grijns and Noyons nor Zwaardemaker actually measured the energies involved, but relied on Ångström's (1903) determinations of the energy distribution in the Hefner lamp.

The best of the early efforts is by von Kries and Eyster (1907); and though the results involve many calculations, they come very close to the most careful of modern measurements. Von Kries and Eyster made no direct energy determinations; they measured brightnesses, durations, and areas. The conversion of these factors into final energies requires skill and care in the evaluation of absorptions, reflections, lens factors, and the like, and it is gratifying to see the admirable way in which von Kries accomplished this task.

TABLE I
Minimum Energy for Vision

Wavelength	Energy	No. of quanta	Source
<i>mμ</i>	<i>ergs</i>		
505	$0.66-1.17 \times 10^{-10}$	17-30*	Chariton and Lea (1929)
507	$1.3-2.6 \times 10^{-10}$	34-68	von Kries and Eyster (1907)
530	$1.5-3.3 \times 10^{-10}$	40-90	Barnes and Czerny (1932)

* For inexperienced observers.

Computations from star magnitudes were made by Ives (1916) and by Russell (1917). However, neither they nor Reeves (1917) and Buisson (1917), who both reproduced star observations in the laboratory, employed the best physiological conditions for the measurements. Moreover, none of them took consideration of the different luminosity curves for rod vision and cone vision, and used the latter as standard in the computations.

Direct energy measurements were made by du Noüy (1921), but his work involves serious physical errors, and his results are too low by a factor of more than 100—so low indeed as to seem impossible.

The most recent determinations are by Chariton and Lea (1929), by Wentworth (1930), and by Barnes and Czerny (1932), all of whom agree in the order of magnitude of their results. Wentworth's exposures were too long to yield minimal values; otherwise her work is excellent. She measured the energies involved, which Barnes and Czerny also did, but not as directly.

From these twelve researches, we have chosen the three sets of measurements which are free from what can now be recognized as obvious error. These are given in Table I. Even though they differ by a factor of about 3, these data can be considered as roughly confirming one another. However,

since for our purposes a factor of 3 cannot be ignored, we undertook to make the measurements again, but under the best physical and physiological conditions.

II

Visual Conditions

The circumstances which will yield the maximum retinal sensibility have been adequately known for years. They involve dark adaptation, peripheral vision, small test fields, short exposures, and selected portions of the spectrum.

Complete dark adaptation means a stay of at least 30 minutes in the dark before measurements can be begun (Piper, 1903; Hecht, Haig, and Chase, 1937). After thorough dark adaptation the periphery of the retina is much more sensitive than its center. The greatest density of rod elements begins at about 18° out (Østerberg, 1935), and exploration shows that between 20° and 30° from the center there is a region of maximum sensibility to light (Wentworth, 1930). The variation within this region is not large, and for convenience we chose a retinal area situated 20° temporally on the horizontal axis.

In visual threshold measurements it has been established that the larger the test area, the smaller need the intensity be for its recognition (*cf.* summary by Wald, 1938 *a*). This reciprocal relation is exact only for small areas. Our preliminary experiments, as well as the work of other investigators, show a minimum for the product of area and intensity for fields of the order of 10 minutes diameter. We therefore chose a circular retinal area of 10 minutes diameter for the test field.

The energy required to pass over the visual threshold involves an approximately reciprocal relationship between intensity and time of exposure. For exposures shorter than 0.01 second, the reciprocal relation holds perfectly (Graham and Margaria, 1935). To be sure of falling within this most efficient range, our exposures were 0.001 second long.

Finally, from the measurements of the scotopic luminosity curve (Hecht and Williams, 1922), it is known that for dim vision the eye is most sensitive to a wavelength of $510\text{ m}\mu$, and this is the light which we used for making the measurements.

III

Apparatus and Calibrations

The physical arrangements may be seen in Fig. 1. The light source L is a ribbon filament lamp run on constant current obtained from storage cells and measured potentiometrically. By means of a lens, it is focussed on the slit of a double monochromator M_1M_2 and finally on the artificial pupil P . The subject, who sits in a dark cabinet in the dark room, has his head in a fixed position by keeping his teeth in a "bite" or hard impression of his upper jaw. He has his left eye next to the pupil P , and on looking at the red fixation point FP he sees the field lens FL . The light intensity of this

uniformly illuminated field is varied in large steps by the neutral filters F , and in a gradual way by the neutral wedge and balancer W . The size of the field is controlled by the diaphragms D . Its exposure is fixed by the shutter S , and is initiated by the subject.

For the record it is necessary to describe the apparatus and calibrations in detail. The double monochromator is made of two individual constant deviation monochromators, M_1 and M_2 , which are arranged for zero dispersion by means of the reversing prism RP . In this way, all the light passes through an equal thickness of glass, and assures a uniform brightness of the field lens FL . The exit slit of M_1 has been removed, and the entrance slit of M_2 serves as the middle slit of the combined double monochromator. The entrance and exit slits of the combination are kept at 1.2 mm., which corresponds to a band width of 10 $m\mu$ centered at 510 $m\mu$. The middle slit, before which the shutter is placed, is kept at 0.1 mm.

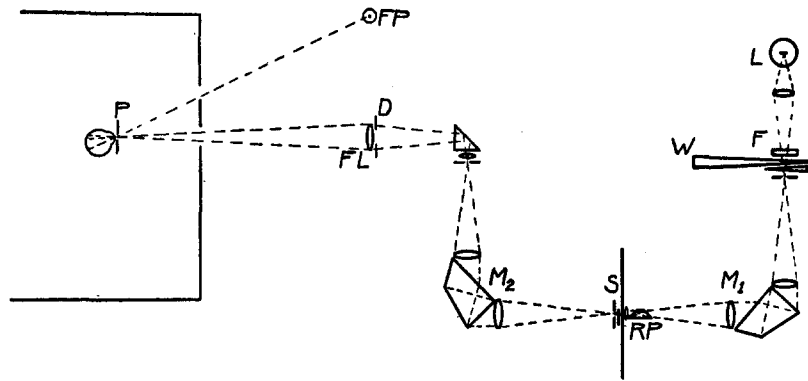

FIG. 1. Optical system for measuring minimum energies necessary for vision. The eye at the pupil P fixates the red point FP and observes the test field formed by the lens FL and the diaphragm D . The light for this field comes from the lamp L through the neutral filter F and wedge W , through the double monochromator M_1M_2 and is controlled by the shutter S .

The field lens FL magnifies the exit slit by a factor of 2, and thus yields an image of it 2.4 mm. wide and over 10 mm. high at the pupil P . The image is sufficient to cover uniformly not only the pupil P , but also the linear thermopile used for the energy calibration. The pupil mount at P and the field lens FL are connected by a carefully diaphragmed and blackened tube. The 2 mm. circular pupil P used for the visual measurements can be replaced by a slit 2 mm. wide and 10 mm. high behind which is the receiving surface of the thermopile for energy measurements.

S is a precision shutter made of two parts. One part is a thin circular aluminum disc with a small sector of 10.8° removed and properly balanced. It is run at 1800 R.P.M. by means of a synchronous motor, and therefore permits light to pass through the middle slit for 1/1000 second during each revolution. The other part is a polar relay shutter, which, by means of a phasing commutator on the shaft of the synchronous motor, is opened for only one passage of the rotating disc aperture whenever the subject releases a push button.

The essentials of the shutter are shown in diagrammatic detail in Fig. 2. On the same shaft with the disc there is mounted a commutator having a "live" sector, which together with the brush occupies somewhat less than 90° . Two brushes are arranged on this commutator 90° apart, and are so phased with the a.c. line voltage that one of these brushes receives only a positive impulse while the other receives only a negative impulse. These impulses control a polar relay PR_2 , which then actuates a pair of single pole, double throw micro switches, MS_1 and MS_2 . These are arranged with their springs in opposition in such a manner that the switches are in equilibrium

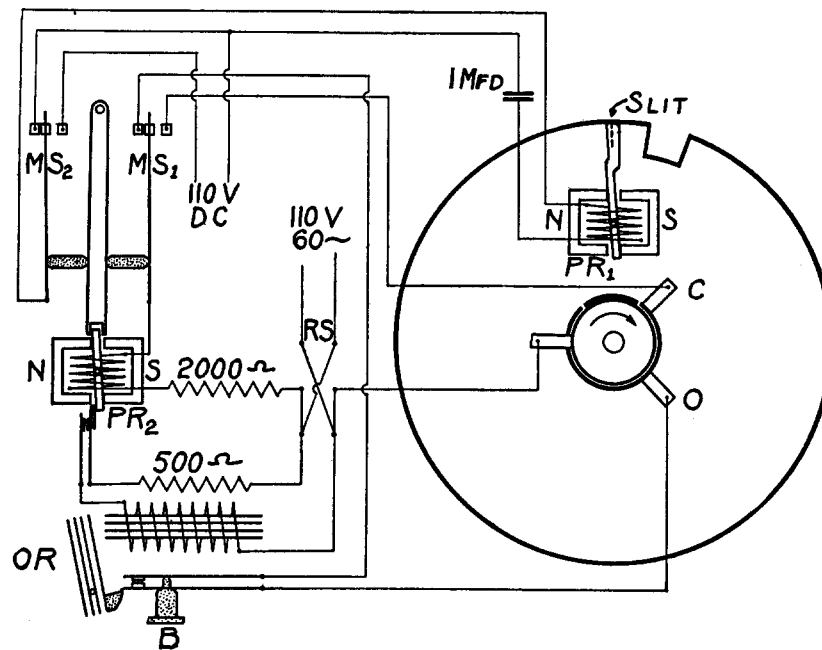

FIG. 2. Shutter for obtaining a single exposure of $1/1000$ second. The details are described in the text.

at either of their two positions, and require but a small force and movement to kick them over to their other positions. Micro switch MS_1 is in series with the winding of PR_2 , and in one position connects with the opening brush O and in the other position with closing brush C . The other micro switch, MS_2 , charges and discharges a $1 \mu\text{fd}$. condenser from the 110 volt, d.c. line through the polar relay PR_1 . These impulses in and out of the condenser actuate PR_1 whose armature movement then uncovers and covers the middle slit.

The operation is seen by following a single cycle of operation of circuit and shutter. Fig. 2 shows the apparatus during its rest or closed period. The 110 volt, 60 cycle power enters through a pole-reversing switch, RS , to the neutral brush on the commutator. The impulse through the closing brush C is blocked, since it enters an open

contact in MS_1 . The impulse going to the opening brush O is blocked at the secondary contacts of the overload relay OR , the push button of which, B , is controlled by the observer. When B is released so that contact is made, the next impulse which leaves the opening brush O goes through the left hand contact of MS_1 , through the winding of PR_2 , and through a 2,000 ohm resistance to the other side of the power line. This impulse through PR_2 is adequate to throw its armature to the other position, thus switching over both MS_1 and MS_2 , and closing the power circuit through the primary of the overload relay OR . The activation of OR closes its armature, whose movement opens the secondary contacts attached to it, thereby breaking the circuit from the opening brush O so that the cycle does not repeat itself. The switching of MS_2 to its right contact charges the 1 μ fd. condenser through PR_1 , which moves its armature and thereby exposes the slit. The switching of MS_1 to its right contact sets the circuit for the very next impulse through the closing brush C to PR_2 . This closing impulse comes exactly three half-cycles or $3/120$ second after the original opening impulse, and causes PR_2 to return to its original position. Now MS_2 discharges the 1 μ fd. condenser, which actuates PR_1 so that its armature moves to cover the slit and terminate the cycle.

The pole-reversing switch RS enables one to select the correct polarity for the operation of this circuit. It needs to be set only at the beginning of an experiment when the synchronous motor is first started.

PR_1 and PR_2 are old Baldwin speaker units in which all the spring tension restraint of the armature has been removed; they thus act as very fast polar relays. An oscillographic study of PR_2 , which is essentially unloaded, shows that the micro switches are thrown to the right contacts before the end of the half cycle which actuates it. However, PR_1 , due to the loading of the shutter vane attached to the armature, is not nearly so fast, but opens in less than $3/120$ second and closes in less than $4/120$ second, which are the limits required for its operation. MS_1 and MS_2 are a pair of micro switches, type Z_1 -BZ-R, selected for near equality of spring tension. They are mounted plunger to plunger with a loose bar between them. This bar has a fulcrum at one end, and a fork at the other. Inside the fork is located the armature of PR_2 . The fork width is so adjusted that it offers no resistance to the movement of the armature except at the very end of its motion when the impact of the armature is sufficient to kick over both micro switches.

It was necessary to calibrate the neutral filters, the wedge and balancer, the diaphragm openings, and the energy at the pupil P . The filters and the wedge and balancer were measured with our photoelectric spectrophotometer (Shlaer, 1938) at the same wavelength used in the experiments, and in an analogous optical position in front of the entrance slit of the first monochromator. We first used filters and wedges made of gelatin; later they were replaced with neutral glass. The smaller diaphragms were calibrated under the microscope with a filar micrometer by measuring several diameters for each opening; the larger ones were similarly measured with a comparator.

The energy density at the pupil P was measured with a Hilger linear thermopile and a Paschen galvanometer. The thermopile was first standardized against a standard carbon filament lamp of known energy radiation. To do this we used the tube holding the pupil and the field lens, first removing the field lens and substituting

the slit for the pupil, and fixing the thermopile immediately behind the slit. This assembly of tube, slit, and thermopile was then mounted on an optical bench so that the standard lamp was at the specified distance of 2 meters from the receiver of the thermopile. The thermopile and its end of the tube was then covered with a thermos flask and allowed to reach thermal equilibrium. Between the source and the opening of the tube was mounted a triple leafed shutter with about 20 cm. spacing between the leaves. The surfaces facing the thermopile were blackened while those facing the source were shiny. This shutter was used to open and close the radiation to the thermopile.

The thermopile was connected to a Paschen galvanometer, which is a moving magnet type of very high sensitivity (about 2×10^{-9} volts per mm. at a meter). In series with the thermopile and galvanometer was a resistance of about 0.1 ohm, across which known potentials could be inserted to counterbalance the potential generated by the thermopile, thus using the galvanometer as a null point instrument. The radiation was first permitted to fall on the thermopile, and the galvanometer brought back to zero by means of measured counter-potentials. The radiation was then occluded and the counter-potential switched off to check the zero of the galvanometer. In this way we could measure large potentials corresponding to galvanometer swings of several meters without actually using such scale distances. The thermopile was calibrated as potential *vs.* radiant energy density incident upon its receivers for three different energy densities which covered a range of about 3 to 1, and included the actual energy density delivered by the ribbon filament lamp and the monochromators.

For calibrating the energy density through the monochromators, the field lens was replaced in the tube and the tube placed in its correct position in the apparatus. Diaphragm *D* was removed, the middle slit of the monochromator was opened to 1.5 mm., and the wedge and balancers were removed. The energy was then measured with the same thermopile and the same electrical system. With the lamp current at 19 amperes, the energy density at the pupil *P* was 27.5 microwatts per square centimeter; with the current at 18 amperes, it was 18.3 microwatts per square centimeter. In the early visual determinations we used the lamp at 19 amperes; in the later determinations at 18 amperes.

In order to convert these measurements into values of the energy at the pupil during the visual determinations, it is necessary to reduce the measured energy density by factors corresponding (*a*) to the change of the middle slit from 1.5 to 0.1 mm., (*b*) to the change in aperture of the field lens from its largest opening of 25.9 mm. diameter to the sizes of the particular diaphragms used, and (*c*) to the insertion of the wedge and balancer. All these factors were known from previous separate measurements, but we calibrated them again in their places in the apparatus by means of a sensitive dry-disc photocell in place of the thermopile behind the thermopile slit. The results merely confirmed the previous calibrations. By applying these reduction factors for the wedge at its thinnest place, the middle slit at 0.1 mm., the 10 minute diaphragm at the field lens, and the 2 mm. pupil at *P*, we found that the energy density through the pupil is 3.4×10^{-4} ergs per second when the ribbon filament lamp is running at 18 amperes. The energy calibrations were run through twice several months apart and agreed almost perfectly.

IV

Visual Measurements

From the subject's point of view, an experiment involves the report of whether or not he has seen a flash of light after he has opened the shutter for an exposure. Fixation of the red point need not be continuous, a circumstance which avoids undue fatigue. The observer is told by the operator that conditions are set and that he should try a flash when he is ready. He fixates

TABLE II

Minimum Energy for Vision

Each datum is the result of many measurements during a single experimental period, and is the energy which can be seen with 60 per cent frequency. $\lambda = 510 \text{ m}\mu$; $h\nu = 3.84 \times 10^{-12}$ ergs.

Observer	Energy	No. of quanta	Observer	Energy	No. of quanta	
	<i>ergs</i> $\times 10^{10}$			<i>ergs</i> $\times 10^{10}$		
S. H.	4.83	126	C. D. H.	2.50	65	
	5.18	135		2.92	76	
	4.11	107		2.23	58	
	3.34	87		2.23	58	
	3.03	79	M. S.	3.31	81	
	4.72	123		4.30	112	
S. S.	5.68	148	S. R. F.	4.61	120	
	3.03	79		A. F. B.	3.19	83
	2.07	54			M. H. P.	3.03
	2.15	56	3.19	83		
	2.38	62	5.30	138		
	3.69	96				
	3.80	99				
3.99	104					

the red point, and at the moment which he considers propitious, he exposes the light to his eye. The operator changes the position of the wedge, or removes or introduces a filter until he is satisfied with the precision of the measurements.

In the early measurements we considered that the threshold had been reached when the observer saw a flash of light at a given intensity six times out of ten presentations. Later the measurements were made somewhat more elaborately. Each of a series of intensities was presented many times and the frequency of seeing the flash was determined for each. From the resulting plot of frequency against intensity we chose the threshold as that amount of light which could be seen with a frequency of 60 per cent.

During 1940 and 1941 we measured the threshold for seven subjects. With

four we made several determinations each, extending over a year and a half; one subject we measured on two occasions 3 months apart; and two we measured only once. For all these observers the minimum energy necessary for vision ranges between 2.1 and 5.7×10^{-10} ergs at the cornea. These small energies represent between 54 and 148 quanta of blue-green light. The results for the individual subjects are in Table II, and are given as energy and as the number of quanta required.

It is to be noticed that these values are of the same order of magnitude as those of von Kries and Eyster, and of Barnes and Czerny, but almost twice as large. Because of the fairly wide ranges, these previous measurements and our own overlap to some extent, and it is conceivable, though not probable, that their observers may actually have needed somewhat smaller energies than ours. Chariton and Lea's results, however, are much too small. Actually their value of $17 h\nu$ is an extrapolation to zero frequency of seeing; if we take as threshold a 60 per cent frequency, their data come more nearly to $25 h\nu$. This is still too small a value, and is probably in error, as will be apparent in later sections of our paper.

v

Reflections and Absorptions

The values in Table II, as well as those of previous investigators, are the energies incident at the cornea. Nevertheless the tacit supposition has generally been made that they represent the actual energies necessary to initiate a visual act. It is important to recognize that this assumption is incorrect. Before one can know how many quanta are required to start the visual process, one must apply at least three corrections to the measurements.

The first is reflection from the cornea. This is about 4 per cent and is obviously of not much importance. The second involves loss by the ocular media between the outer surface of the cornea and the retina. It has been common opinion that this loss is small. However, the measurements of Roggenbau and Wetthauer (1927) on cattle eyes, as well as the recent measurements of Ludvigh and McCarthy (1938) on human eyes, have shown that this loss is large. From the values of Ludvigh and McCarthy it appears that at $510 m\mu$ the ocular media transmit almost exactly 50 per cent of the light entering the cornea of a young person, and less of an older one.

The next correction is much more difficult to evaluate with precision and involves the percentage of the energy absorbed by the retinal elements themselves. Since visual purple is the photosensitive substance concerned in this particular act, light which is not absorbed by it is visually useless. One cannot assume that visual purple absorbs all the light incident on the retinal cells. The fraction which it does absorb must be found by experiment.

Koenig (1894) determined the absorption of the total amount of visual

purple which can be extracted from the human eye. If this amount of visual purple is spread evenly over the whole retina, his data show that it will absorb only 4 per cent of light of 510 $m\mu$. This is a small value. Nevertheless, it is about the same as the 4 per cent and the 13 per cent recently found by Wald (1938 *b*) with a similar method for the absorption of the visual purple of the rabbit and rat retinas respectively.

These figures are probably too low, first because it is unlikely that all of the visual purple in the eye has been extracted, and second, because visual purple is not evenly distributed over the retina. It is lacking in the fovea; and even in the periphery the density of the rods is known to vary in a definite way. However, these absorptions may be considered as lower limiting values.

VI

Visual Purple Absorption

We have estimated the absorption of visual purple in the retina in a completely independent manner by comparing the percentage absorption spectrum of different concentrations of visual purple with the scotopic (rod) luminosity curve of the eye measured at the retina. The comparison rests on the fact that the shape and width of the percentage absorption spectrum of a substance varies with its concentration, and that the luminosity curve must represent the percentage absorption curve of a particular concentration of visual purple in the retina.

Fig. 3 shows the absorption spectrum of frog's visual purple as determined by Chase and Haig (1938) in our laboratory, by Lythgoe (1937) in London, and by Wald (1938 *b*) at Harvard. The agreement of the data is obvious, and shows that the absorption spectrum of visual purple may be considered as well established. Table III gives the average of these three series of measurements computed so that the maximum density at 500 $m\mu$ has a value of 1.

From these data in Table III we may prepare a series of percentage absorption spectra for different concentrations of visual purple. Since we are not interested in the absolute concentration of visual purple, but rather in its absorption capacities, we can deal with the series of percentage absorption spectra entirely in terms of maximum absorption. It will be recalled that the photometric density d is related to the transmission I_t by the equation $d = \log(1/I_t)$, and since the absorption $I_a = 1 - I_t$, it is a simple computation to find the percentage absorption corresponding to any density value, or the reverse.

We have made such computations for a variety of visual purple densities, and Fig. 4 shows the resulting percentage absorption curves for the different maximal absorptions of visual purple. For comparisons among the curves in Fig. 4 the maxima have all been made equal to 1, but their actual values are

indicated in the figure. It is clear that the width of the curves increases as the concentration of visual purple increases.

The scotopic luminosity curve, as measured experimentally, records the reciprocal of the relative energy in different parts of the spectrum required for the production of a constant and very low brightness in the eye (Hecht and Williams, 1922). If this is to be compared with the absorption spectrum of

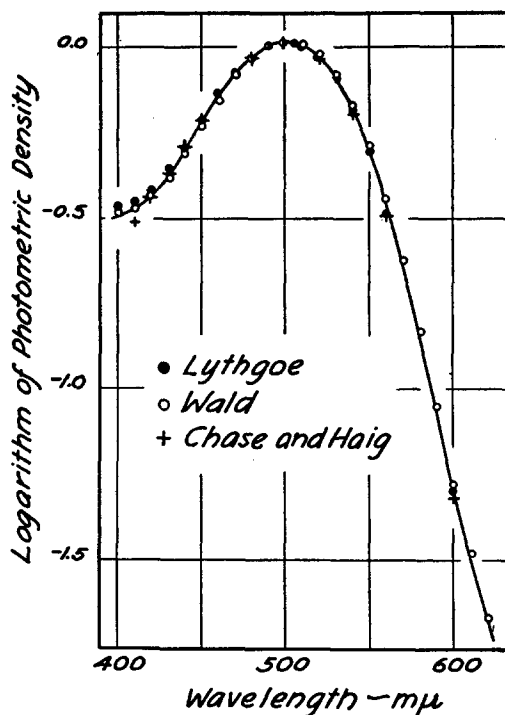

FIG. 3. Absorption spectrum of frog's visual purple. The data from the three sources have been made equal at 500 mμ.

visual purple, it must be converted into a quantum luminosity curve instead of an energy luminosity curve, because it is the number of quanta which determines the photochemical effectiveness of light and not just its energy content (Dartnall and Goodeve, 1937). Moreover, since our interest lies in retinal comparisons, the luminosity curve must be corrected for ocular media absorption in terms of the data of Ludvigh and McCarthy.

The scotopic luminosity data have been corrected in these two ways; the computed values are given in Table IV and shown as circles in Fig. 5. Included in the same figure are two percentage absorption spectra of visual purple; the

upper curve represents 20 per cent maximal absorption, while the lower curve is 5 per cent maximal absorption.

TABLE III
Absorption Spectrum of Visual Purple
Average of data from Chase and Haig (1938), Wald (1938 *b*), and Lythgoe (1937).

$\lambda - m\mu$	Density	$\lambda - m\mu$	Density	$\lambda - m\mu$	Density
400	0.306	480	0.900	560	0.321
410	0.317	490	0.967	570	0.207
420	0.353	500	1.000	580	0.131
430	0.408	510	0.973	590	0.0805
440	0.485	520	0.900	600	0.0473
450	0.581	530	0.780	610	0.0269
460	0.691	540	0.628	620	0.0150
470	0.811	550	0.465		

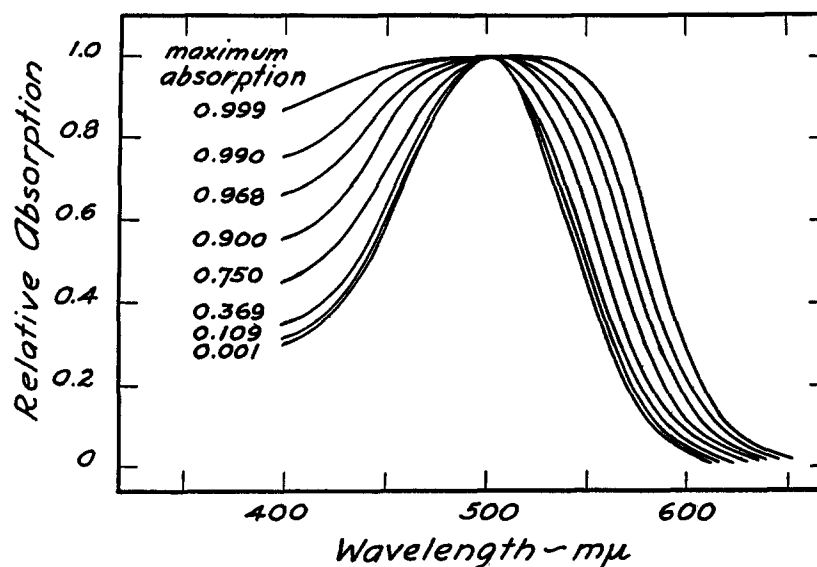

FIG. 4. Percentage absorption spectra of various concentrations of visual purple. For convenience in comparing the shapes of the curves, their maxima have all been equated to 1 and superimposed. The actual fraction absorbed at the maximum is shown for each curve. It is apparent that with increasing concentration the absorption curve steadily increases in width.

For comparing the luminosity and absorption data, it is well to confine our attention mostly to the long wave half of the luminosity curve because of the larger number of points involved. From the comparison it is apparent that the 5 per cent maximum absorption curve describes the points quite well, but

TABLE IV

Rod Luminosity Distribution in Spectrum

The original energy luminosity data of Hecht and Williams (1922) in column 2, when divided by the corresponding wavelengths in column 1, yield the quantum luminosity values in column 3 after being multiplied by a factor so that the maximum at 511 $m\mu$ equals 1. When these values in column 3 are divided by the ocular media transmission data in column 4 from Ludvigh and McCarthy (1938), they yield the spectral luminosity distribution at the retina given in column 5 after multiplication by a factor so that the maximum at 502 $m\mu$ is 1.

$\lambda - m\mu$	Energy luminosity at cornea	Quantum luminosity at cornea	Ocular transmission	Quantum luminosity at retina
412	0.0632	0.0779	0.116	0.336
455	0.399	0.447	0.410	0.545
486	0.834	0.874	0.472	0.926
496	0.939	0.964	0.490	0.984
507	0.993	0.998	0.506	0.986
518	0.973	0.957	0.519	0.921
529	0.911	0.877	0.540	0.812
540	0.788	0.743	0.559	0.665
550	0.556	0.515	0.566	0.455
582	0.178	0.155	0.596	0.131
613	0.0272	0.0226	0.625	0.0181
666	0.00181	0.00139	0.672	0.00104

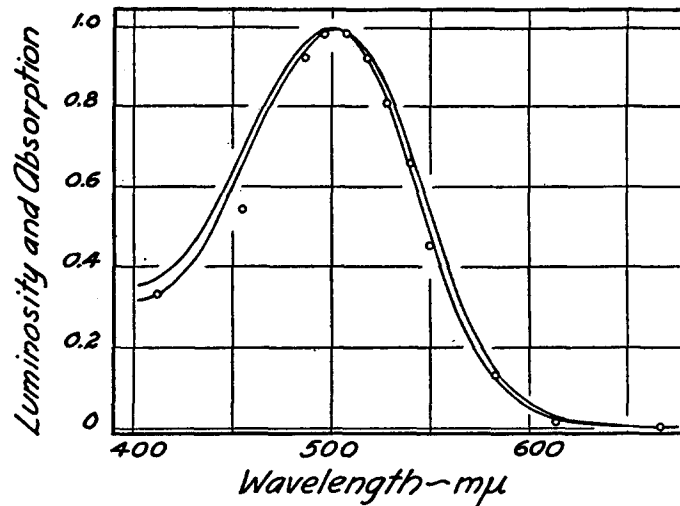

FIG. 5. Comparison of scotopic luminosity at the retina with visual purple absorption. The points are the data of Hecht and Williams corrected for quantum effectiveness and ocular media transmission. The curves are the percentage absorption spectra of visual purple; the upper curve represents 20 per cent maximal absorption, and the lower one 5 per cent maximal absorption. All curves have been made equal to 1 at the maximum, 500 $m\mu$, for ease in comparison.

that the 20 per cent curve is definitely excluded, because its absorption on both sides is just too high. The 10 per cent absorption curve, not shown in the figure, is perhaps slightly better than the 5 per cent one; it cuts through more points. In any case, both values are of the same order of magnitude as those found by Koenig and by Wald. However, to be quite safe, we may take 20 per cent as the upper limit for the absorption of 510 $m\mu$ by the visual purple in the human retina after complete dark adaptation.

VII

Energy Absorbed by the Rods

It is clear now why the 54 to 148 quanta required at the cornea cannot represent the energy actually employed in vision. About 4 per cent of this incident light is reflected by the cornea; almost precisely 50 per cent is absorbed by the lens and other ocular media; and of the rest, at least 80 per cent passes through the retina without being absorbed. If corrections are made for these factors, the range of 54 to 148 quanta at the cornea becomes as an upper limit 5 to 14 quanta absorbed by the visual purple of the retina.

Visual purple is in the terminal segments of the rods, and the 10 minute circular visual field contains about 500 rods (Østerberg, 1935). Since the number of absorbed quanta is so small, it is very unlikely that any one rod will take up more than one quantum. In fact, the simplest statistical considerations show that if 7 quanta are absorbed by 500 rods, there is only a 4 per cent probability that 2 quanta will be taken up by a single rod. We may therefore conclude that in order for us to see, it is necessary for only 1 quantum of light to be absorbed by each of 5 to 14 retinal rods.¹

It is very likely that the photodecomposition of visual purple in solution has a quantum efficiency of 1 (Dartnall, Goodeve, and Lythgoe, 1938). Our data then mean that 1 molecule of visual purple needs to be changed simultaneously in each of 5 to 14 rods, in order to produce a visual effect. This is indeed a small number of chemical events, but by virtue of its very smallness, its reality may be tested in an entirely independent manner.

VIII

Poisson Distributions

The energy calibration of the light gives merely the average number of quanta per flash. This is in the nature of the measurement, because the

¹ These data disprove the supposition made by Granit, Holmberg, and Zewi (1938) that most of the visual purple in the retina is inert as sensory substance, and that sensory impulses from the rods are "initiated by the bleaching of a thin surface film, which had to contain only an immeasurably small fraction of the total quantity present" (Granit, Munsterhjelm, and Zewi, 1939). Since the maximum visual purple concentration which the retina can achieve is able to absorb only 5 to 14 quanta at the threshold of vision, a very small fraction of the total visual purple would absorb much less than one quantum and would be ineffective for visual purposes.

thermopile records only the energy density, which is the number of quanta per second from a continuously incident light. Each flash, however, will not always deliver this average number. Sometimes the flash will yield fewer, sometimes more, quanta.

Since absorption of this group of quanta by the retina represents discrete and independent events which occur individually and collectively at random, the actual number of such retinal events which any given flash provides will vary according to a Poisson probability distribution (Fry, 1928). Let n be the number of quanta which it is necessary for the retina to absorb in order for us

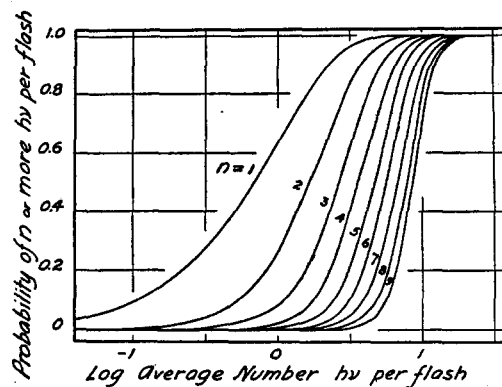

FIG. 6. Poisson probability distributions. For any average number of quanta ($h\nu$) per flash, the ordinates give the probabilities that the flash will deliver to the retina n or more quanta, depending on the value assumed for n .

to see a flash of light. Let a be the average number of quanta which any flash yields to the retina. Then the Poisson distribution states that

$$P_n = a^n / e^n n!$$

in which P_n is the probability that the flash will yield the necessary n quanta, and e is the base of natural logarithms. A special virtue of the Poisson distribution is that it has only one parameter, and is thus determined when the average number a is set. The values of P_n for various values of a and n are available in printed tables (e.g. Fry, 1928).

Since for us to see a flash of light the retina must absorb n quanta, we shall also see when the retina absorbs more than n quanta. From the published Poisson distributions, one can then compute the probability that n or more quanta will be delivered to the retina in a given flash when the average number of quanta delivered by that flash is known. The values computed in this way for different values of a and n are shown in Fig. 6.

There are two significant features of Fig. 6. One is that the shape of the distributions is fixed and different for every value of n . The curve becomes

steeper as n increases. It follows from this that if the probability distribution could be determined by experiment, its shape would automatically reveal the value of n corresponding to it.

Another and equally important feature of Fig. 6 is that the relationship is expressed in terms of the logarithm of the average number of quanta per flash. Therefore, for comparison with the distributions in Fig. 6, the experiments need not employ the absolute values of the average number of quanta delivered per flash, but merely their relative values.

The experiments may then be made quite simply. On many repetitions of a flash of given average energy content, the frequency with which the flash is seen will depend on the probability with which it yields n or more quanta to the retina. When this frequency is measured for each of several intensities, a distribution is secured whose shape, when plotted against the logarithm of the average energy content, should correspond to one of the probability distributions in Fig. 6, and should thus show what the value of n has been.

IX

Frequency of Seeing

We have made determinations of this kind. The experimenter varies the intensity of the light by placing the wedge in specific positions unknown to the observer. The observer then elicits the flash whenever he is ready, and merely reports whether he has seen it or not. The intensities are presented in a deliberately random sequence, each for a specific number of times, usually 50. The procedure is simplified for the operator by a series of accurately made stops against which the wedge may be rapidly set in predetermined positions. A complete series in which six intensities are used requires about $1\frac{1}{2}$ hours of continuous experimentation composed of two or three periods of intensive work.

The comfort of the observer is of great importance and this must be at a maximum. It is equally important that fixation should not be rigidly continuous because this is fatiguing. Above all, the observer must be on guard to record any subjective feelings of fatigue the moment they become apparent. The experiment is much facilitated by the fact that the observer controls the occurrence of the flash, and can set it off only when he is thoroughly fixated and ready for an observation.

The data for the three observers who engaged in this experiment are given in Table V. One experiment for each observer is plotted in Fig. 7. The points in the figure record the percentage frequency with which a flash of light is seen for flashes of average quantum content shown in the abscissas. Comparison with the curves in Fig. 6 shows that the measurements are best fitted by Poisson distributions in which n is 5, 6, and 7 quanta per flash. For the two other

experiments in Table IV, n is 7 and 8. No special statistical methods are necessary to determine which curve fits the data, since smaller and larger values of n are easily excluded by the simplest visual comparison.

TABLE V
Energy and Frequency of Seeing

Relation between the average number of quanta per flash at the cornea and the frequency with which the flash is seen. Each frequency represents 50 flashes, except for S. H. for whom there were 35 and 40 for the first and second series respectively.

S. H.		S. H.		S. S.		S. S.		M. H. P.	
No. of quanta	Frequency	No. of quanta	Frequency	No. of quanta	Frequency	No. of quanta	Frequency	No. of quanta	Frequency
	<i>per cent</i>		<i>per cent</i>		<i>per cent</i>		<i>per cent</i>		<i>per cent</i>
46.9	0.0	37.1	0.0	24.1	0.0	23.5	0.0	37.6	6.0
73.1	9.4	58.5	7.5	37.6	4.0	37.1	0.0	58.6	6.0
113.8	33.3	92.9	40.0	58.6	18.0	58.5	12.0	91.0	24.0
177.4	73.5	148.6	80.0	91.0	54.0	92.9	44.0	141.9	66.0
276.1	100.0	239.3	97.5	141.9	94.0	148.6	94.0	221.3	88.0
421.7	100.0	386.4	100.0	221.3	100.0	239.3	100.0	342.8	100.0

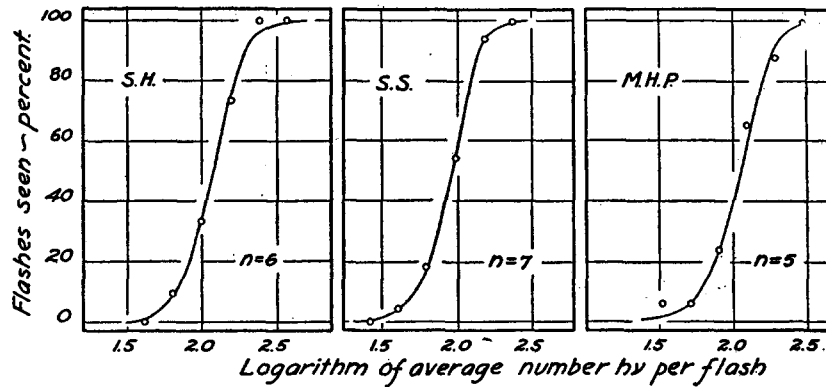

FIG. 7. Relation between the average energy content of a flash of light (in number of $h\nu$) and the frequency with which it is seen by three observers. Each point represents 50 flashes, except for S.H. where the number is 35. The curves are the Poisson distributions of Fig. 6 for n values of 5, 6, and 7.

From these measurements it is apparent that the number of critical events in the retina required to produce a visual effect lies between 5 and 8. These values are in such good agreement with the results determined by the straightforward physical measurements already described that we must consider them as the actual number of quanta absorbed by the retina.

X

Physical Fluctuation and Biological Variation

It is unimportant that the number of quanta delivered to the cornea is very much higher than the number finally involved in vision according to these measurements. This is because most of the light incident on the cornea is wasted and does not contribute to the initiation of a visual act. The amount falling on the cornea could be greatly increased by any arrangement in the eye which would act as a filter. Thus, the cornea and the lens might be pigmented, and this probably contributes to the fact that the oldest investigator (S.H.) actually requires the highest number of quanta incident on the cornea. Indeed, one might even put a filter immediately in front of the eye since the precise position of the filter in the optical system is immaterial. Nevertheless, the probability distributions would still remain the same, and by their shape would yield the magnitude of the number of events involved in the visual act.

It is necessary to amplify this point somewhat. Fluctuations are part of all physical systems, but they become significantly large only when the number of individual events, in the modern physical sense, is small. The general phenomenon is known as the shot-effect and has been studied extensively in electron emission, though it has wide application in the problem of measurements (Schottky, 1922; Barnes and Czerny, 1932). As a rough approximation, one may say that the range of variation is proportional to the square root of the number of individual events involved in the process.

In the optical system of our apparatus, the light from the ribbon filament lamp varies in intensity from moment to moment, but because the number of quanta emitted is enormous, the variation is almost too small to be measured. However, when the light intensity has been reduced first by the filters and wedge, then by the monochromators, then by the shutter, then by the ocular media, and finally by the retina itself, it has become so low that it represents only a few quanta per flash, and is therefore subject to great variation.

Barnes and Czerny (1932), and following them Brumberg and Vavilov (1933) realized that fluctuations must occur in the energy necessary for vision, and both groups of investigators looked for them. But they both missed the point of where the source of the fluctuations is and supposed it to be the energy deposited at the cornea. Brumberg and Vavilov even expected differences in the fluctuations for different wavelengths because of the greater energy required for seeing red light, for example, than blue-green light in conformity with the scotopic visibility curve of Fig. 5. However, the comparisons in Fig. 5 show that the differences in number of quanta required for vision in different parts of the spectrum record merely their relative absorption by visual purple. The number of absorbed quanta for an ultimate effect is the same regardless of wavelength and it is this number which sets the magnitude of the physical fluctuation encountered.

In deriving the curves of Fig. 6 for the quantitative statement of this physical fluctuation in terms of the Poisson probability distribution, we have made the single assumption that a constant number of quanta n must be absorbed by the retina in order for us to see a flash of light. Since it is conceivable, in view of the variability of an organism from moment to moment, that this value n is not constant, we have considered the consequences of assuming that the number n varies from time to time. The results show that biological variation is a factor of no great importance.

The situation may be best made clear by an example. Suppose that instead of n being constant, it varies between 4 and 8 quanta per visual act, and that the frequency with which 4, 5, 6, 7, and 8 quanta are necessary is distributed in terms of an ordinary probability distribution. The curves in Fig. 6 representing the frequency distributions for various values of n may then be weighted in this way and averaged. The average curve which is then secured is practically the same as the original Poisson distributions in Fig. 6, and may be fitted by the curves for $n = 4$ or 5.

Thus, when biological variation is imposed upon the physical variation, there is no change in the essential characteristics of the physical distribution. Instead, the value of n merely falls below the average of the biological distribution, and is never below the lowest value in the distribution. This tells us that when, as in Fig. 7, the measurements yield n values of 5, 6, or 7, these numbers represent lower limiting values for the physical number of quanta. In other words, the only effect which biological variation has on the physical variation is to decrease the slope of the curves in Fig. 7 and thus make the apparent number of quanta smaller than the real number.

These considerations serve for understanding the meaning of the fluctuations shown by an organism in its response to a stimulus. It has generally been assumed that a constant stimulus, when presented frequently, remains constant, and that the fluctuations in response are an expression of the variations undergone by the organism. Indeed, this is one of the tenets of psychological measurements, and an elaborate structure of psychometrics has grown up on it as a basis (*cf.* Guilford, 1936).

The present evaluation of our measurements shows, however, that at the threshold the emphasis has been in the wrong place. At the threshold where only a few quanta of energy are involved, it is the stimulus which is variable, and the very nature of this physical variability determines the variation encountered between response and stimulus. Moreover, even when biological variation is introduced, it is the physical variation which essentially dominates the relationship.

This is at the absolute threshold. One may wonder, however, whether a differential threshold at any level of intensity may also involve a small number of events which determines the differentiation, and which may therefore be

subject to a similar physical variation as at the absolute threshold itself. Only experiment can decide this.

The fact that for the absolute visual threshold the number of quanta is small makes one realize the limitation set on vision by the quantum structure of light. Obviously the amount of energy required to stimulate any eye must be large enough to supply at least one quantum to the photosensitive material. No eye need be so sensitive as this. But it is a tribute to the excellence of natural selection that our own eye comes so remarkably close to the lowest limit.

SUMMARY

1. Direct measurements of the minimum energy required for threshold vision under optimal physiological conditions yield values between 2.1 and 5.7×10^{-10} ergs at the cornea, which correspond to between 54 and 148 quanta of blue-green light.

2. These values are at the cornea. To yield physiologically significant data they must be corrected for corneal reflection, which is 4 per cent; for ocular media absorption, which is almost precisely 50 per cent; and for retinal transmission, which is at least 80 per cent. Retinal transmission is derived from previous direct measurements and from new comparisons between the percentage absorption spectrum of visual purple with the dim-vision luminosity function. With these three corrections, the range of 54 to 148 quanta at the cornea becomes as an upper limit 5 to 14 quanta actually absorbed by the retinal rods.

3. This small number of quanta, in comparison with the large number of rods (500) involved, precludes any significant two quantum absorptions per rod, and means that in order to produce a visual effect, one quantum must be absorbed by each of 5 to 14 rods in the retina.

4. Because this number of individual events is so small, it may be derived from an independent statistical study of the relation between the intensity of a light flash and the frequency with which it is seen. Such experiments give values of 5 to 8 for the number of critical events involved at the threshold of vision. Biological variation does not alter these numbers essentially, and the agreement between the values measured directly and those derived from statistical considerations is therefore significant.

5. The results clarify the nature of the fluctuations shown by an organism in response to a stimulus. The general assumption has been that the stimulus is constant and the organism variable. The present considerations show, however, that at the threshold it is the stimulus which is variable, and that the properties of its variation determine the fluctuations found between response and stimulus.

BIBLIOGRAPHY

Ångström, K., Energy in the visible spectrum of the Hefner standard, *Physic. Rev.*, 1903, **17**, 302.

- Barnes, R. B., and Czerny, M., Lässt sich ein Schroteffekt der Photonen mit dem Auge beobachten?, *Z. Physik.*, 1932, **79**, 436.
- Brumberg, E., and Vavilov, S., Visuelle Messungen der statistischen Photonenschwankungen, *Bull. Acad. Sc. U.R.S.S.*, 1933, 919.
- Buisson, H., The minimum radiation visually perceptible, *Astrophys. J.*, 1917, **46**, 296.
- Chariton, J., and Lea, C. A., Some experiments concerning the counting of scintillations produced by alpha particles. Part I, *Proc. Roy. Soc. London, Series A*, 1929, **122**, 304.
- Chase, A. M., and Haig, C., The absorption spectrum of visual purple, *J. Gen. Physiol.*, 1938, **21**, 411.
- Dartnall, H. J. A., and Goodeve, C. F., Scotopic luminosity curve and the absorption spectrum of visual purple, *Nature*, 1937, **139**, 409.
- Dartnall, H. J. A., Goodeve, C. F., and Lythgoe, R. J., The effect of temperature on the photochemical bleaching of visual purple solutions, *Proc. Roy. Soc. London, Series A*, 1938, **164**, 216.
- du Noüy, P. Lecomte, Energy and vision, *J. Gen. Physiol.*, 1921, **3**, 743.
- Fry, T. C., Probability and its engineering uses, New York, Van Nostrand, 1928, 476.
- Graham, C. H., and Margaria, R., Area and the intensity-time relation in the peripheral retina, *Am. J. Physiol.*, 1935, **113**, 299.
- Granit, R., Holmberg, T., and Zewi, M., On the mode of action of visual purple on the rod cell, *J. Physiol.*, 1938, **94**, 430.
- Granit, R., Munsterhjelm, A., and Zewi, M., The relation between concentration of visual purple and retinal sensitivity to light during dark adaptation, *J. Physiol.*, 1939, **96**, 31.
- Grijns, G., and Noyons, A. K., Ueber die absolute Empfindlichkeit des Auges für licht, *Arch. Anat. u. Physiol., Physiol. Abt.*, 1905, 25.
- Guilford, J. P., Psychometric methods, New York, McGraw-Hill, 1936.
- Hecht, S., The quantum relations of vision, *J. Opt. Soc. America*, 1942, **32**, 42.
- Hecht, S., Haig, C., and Chase, A. M., The influence of light adaptation on subsequent dark adaptation of the eye, *J. Gen. Physiol.*, 1937, **20**, 831.
- Hecht, S., Schlaer, S., and Pirenne, M. H., Energy at the threshold of vision, *Science*, 1941, **93**, 585.
- Hecht, S., and Williams, R. E., The visibility of monochromatic radiation and the absorption spectrum of visual purple, *J. Gen. Physiol.*, 1922, **5**, 1.
- Ives, H. E., The minimum radiation visually perceptible, *Astrophys. J.*, 1916, **44**, 124.
- Koenig, A., Ueber den menschlichen Sehpurpur und seine Bedeutung für das Sehen, *Sitzungsber. k. Akad. Wissensch.*, Berlin, 1894, 577.
- von Kries, J., and Eyster, J. A. E., Über die zur Erregung des Sehorgans erforderlichen Energiemengen, *Z. Sinnesphysiol.*, 1907, **41**, 394.
- Langley, S. P., The bolometer and radiant energy, *Proc. Am. Acad. Sc.*, 1881, **16**, 342.
- Langley, S. P., Energy and vision, *Phil. Mag.*, 1889, **27**, series 5, 1.
- Ludvigh, E., and McCarthy, E. F., Absorption of visible light by the refractive media of the human eye, *Arch. Ophth.*, Chicago, 1938, **20**, 37.
- Lythgoe, R. J., The absorption spectra of visual purple and of indicator yellow, *J. Physiol.*, 1937, **89**, 331.
- Østerberg, G., Topography of the layer of rods and cones in the human retina, *Acta Ophth., Copenhagen*, 1935, suppl. 6, 106 pp.

- Piper, H., Über Dunkeladaptation, *Z. Psychol. u. Physiol. Sinnesorgane*, 1903, **31**, 161.
- Reeves, P., The minimum radiation visually perceptible, *Astrophys. J.*, 1917, **46**, 167.
- Roggenbau, C., and Wetthauer, A., Über die Durchlässigkeit der brechenden Augenmedien für langwelliges Licht nach Untersuchungen am Rindsauge, *Klin. Monatsbl. Augenheilk.*, 1927, **79**, 456.
- Russell, H. N., The minimum radiation visually perceptible, *Astrophys. J.*, 1917, **45**, 60.
- Shottky, W., Zur Berechnung und Beurteilung des Schroteffektes, *Ann. Physik.*, 1922, **68**, 157.
- Shlaer, S., A photoelectric transmission spectrophotometer for the measurement of photosensitive solutions, *J. Opt. Soc. America*, 1938, **28**, 18.
- Wald, G., Area and visual threshold, *J. Gen. Physiol.*, 1938 *a*, **21**, 269.
- Wald, G., On rhodopsin in solution, *J. Gen. Physiol.*, 1938 *b*, **21**, 795.
- Wentworth, H. A., A quantitative study of achromatic and chromatic sensitivity from center to periphery of the visual field, *Psychological Monographs*, No. 183, Princeton, New Jersey, and Albany, New York, Psychological Review Co., 1930, **40**, 189 pp.
- Zwaardemaker, H., Die physiologisch wahrnehmbaren Energiewanderungen, *Ergebn. Physiol.*, 1905, **4**, 423.