

PROCESSES OF EXCITATION IN THE DENDRITES AND IN THE  
SOMA OF SINGLE ISOLATED SENSORY NERVE CELLS OF  
THE LOBSTER AND CRAYFISH\*

BY CARLOS EYZAGUIRRE† AND STEPHEN W. KUFFLER

(From *The Wilmer Institute, Johns Hopkins Hospital and University, Baltimore*)

(Received for publication, April 4, 1955)

INTRODUCTION

The stretch receptor organs in crustaceans anatomically described by Alexandrowicz (2, 3) and physiologically investigated by Wiersma, Furshpan, and Florey (40) provide a good preparation for the study of many neurophysiological problems. In general design and in some detailed mechanisms of action they resemble the vertebrate muscle spindle. A sensory neuron, with its cell body in the periphery, sends dendrites into the muscular elements of the receptor organ which also possesses motor and inhibitory innervation. The sensory terminals are excited by passive stretch of the receptor or by contractions within the "fast" or "slow" receptor muscles. The efferent neural control and other aspects of the mechanisms of regulation of sensory discharge in this preparation have already been described in detail (30).

This paper presents a study of excitation processes within the dendritic terminals of the sensory neuron, their transmission to the adjacent cell body and to the nerve axon. An analogous problem has already been successfully investigated by Katz (28, 29) in sensory terminals within muscle spindles of the frog and related studies were made by Gray and Sato (21) and Alvarez-Buylla and Ramírez de Arellano (4) in the Pacinian corpuscle of the cat. The wider question of the relationship between local events, set up in receptors by a stimulus, and the subsequent nerve impulses arising in sense organs has received much attention in recent years, especially in studies of the eye (20, 23, 36) and of the ear (see review, 13). The greatest advantage of the present preparation lies in its accessibility since all cellular components can be isolated and visually observed. Further, the state of excitability of the structures can be controlled and graded by utilizing the physiological mechanisms given by the stretch receptor nature of the preparation which provides a very sensitive transducer of mechanical into nervous events. In addition to the

\* Supported by a research grant from the National Institutes of Health, United States Public Health Service.

† Inter-American Fellow of the John Simon Guggenheim Memorial Foundation.

anatomical arrangements which allow a "setting" of the membrane potential level and of excitability, the sensory cell also possesses a direct inhibitory control. Inhibitory synapses are found on the dendritic processes and some of the physiological mechanisms at these junctions will be described in the third paper of this series (31).

It seems of special interest that the sensory nerve cells of Crustacea possess numerous anatomical features which bear a striking resemblance to many central nervous system cells of vertebrates. That they may also have many physiological features in common is strongly suggested by some analogous results of excitation spread in the motoneurons which have been studied with intracellular recording methods (10, 14). In this context it may also be noted that the present preparation provides a cell which can be poised delicately on the verge of activity, maintained in activity, accelerated or depressed—all through mechanisms within the dendrites, not necessarily involving axon-type conduction. A preliminary report of this work appeared some time ago (15).

It may be added at this stage that about 2 years ago when these studies were started this receptor cell was thought to be relatively simple. As will be seen from the subsequent papers, the simplicity of organization of the stretch receptor structures is only a relative one, and it is felt that many additional features of excitatory and inhibitory action have been missed.

#### *Methods*

The majority of experiments were done on the freshwater crayfish *Procambarus alleni* (Faxon). This species is very small, about 2 to 3 inches from tail to head. Some experiments were done on the larger crayfish (*Orconectes virilis* (Hagen)). During the summer months the lobster *Homarus americanus* of the Woods Hole region was used. The main advantage of the lobster, for physiological and other purposes, is its size. In addition to the stretch receptors located in the dorsal portion of each abdominal segment, studied in the last investigation (30), the thoracic receptors were also used. These offer a welcome diversity in anatomical arrangement, well described by Alexandrowicz (3). For instance the median receptor of the seventh segment of the lobster possesses a single sensory neuron which runs in isolation to the central portion of the receptor muscle, while the motor nerves insert elsewhere. In the lateral and medial receptor of the eighth segment the sensory and "accessory" nerves run combined and can be stimulated without exciting motor nerves. Further, while in the abdomen the receptor organs are paired and run side by side, generally with a connective tissue bridge around the region of entry of the nerve fibers, they are separated in the thorax and can be removed individually without more dissection than cutting of tissue strands which link them to the rest of the surrounding musculature. It should be pointed out, however, that the structures are relatively small, especially in *Procambarus* in which the muscular portions of the receptors may be only 15 to 25  $\mu$  thick in certain regions (Fig. 2 B). Therefore utmost care is necessary in handling the tissues. The N cells of Alexandrowicz (3), simple single nerve cells with long dendrites, have not yet been studied.

While the general arrangement of receptors in the lobster and crayfish is similar, some significant differences in innervation have been found by Florey and Florey (18). These authors, studying the crayfish abdominal receptors describe only one accessory fiber (now established to be inhibitory) supplying each sensory nerve cell. This appears to be in agreement with present physiological findings. Although no histological studies are available for the thoracic receptors of crayfish it seems reasonable to assume that they do not differ in their main features from abdominal receptors in respect to accessory innervation of the sensory cell. A schematic drawing of a non-specified sensory nerve cell and a receptor muscle segment in the crayfish is presented in Fig. 1 B. If additional small diameter fibers, supplying the sensory nerve cell exist, they were not detected physiologically. Functionally the lateral receptor of the eighth segment and the receptor element of the accessory muscle of Alexandrowicz gave rise to slowly adapting neurons and their muscular receptor elements were classed as slow, while the median receptors of the seventh and eighth segments have fast adapting sensory neurons and fast muscle strands (30). Most of the present experiments were performed on the second and third abdominal receptors and on the eighth thoracic receptors. Unless otherwise stated, all experiments refer to crayfish. The crayfish receptors survived well for a whole day at 20–23°C. when kept in Van Harreveld's solution (22), while the lobster receptors were studied in Cole's (12) solution. The pH of the solutions was about 7–7.4.

The general experimental set-up is shown in Fig. 1 A. The isolated structures were placed in a lucite dish, the central portions stretched over a small glass plate. The greatest clarity of observation of the nerve cells and axons was obtained when a darkfield and polarized light combination was used. Visualization of the cellular details, such as nucleus, capsule, and parts of the dendrites is necessary for accurate insertion of microelectrodes. Microscopic observation of the living receptors in crayfish reveals a striking difference from the lobster. In the crayfish the receptor muscle is not interrupted by an intercalated tendinous region around the receptor cells which was described by Alexandrowicz (2) in the lobster. Muscle structures thus surround the sensory terminals. This was demonstrated directly in many preparations in which muscle fibers surrounding the sensory terminals were impaled with intracellular leads (*cf.* also section B). These physiological findings confirm Florey and Florey's (18) histological results. The nerve axons were lifted into paraffin oil above the saline solution for stimulation and recording with extracellular electrodes. The external recording electrodes, connected to condenser-coupled amplifiers were usually fine 50  $\mu$  platinum-iridium wires, while for d. c. recording Ag–AgCl cotton thread electrodes were used. If suitably aged they were quite stable.

For intracellular recording micropipettes were filled with 3 M KCl. The external diameter of the tip was 0.5  $\mu$  or less measured with a water immersion objective and an over-all magnification of 1000. These electrodes had a d. c. resistance ranging from 10 to 80 megohms. Under standard recording conditions, using a 20 megohm resistance electrode, the time constant ( $T_c = \frac{1}{\rho}$ ) of the amplifier system was 100  $\mu$  sec. as tested by a square pulse through the microelectrode. This will slow the rising phase of a fast spike potential but would not considerably reduce the peak. The grid current of the cathode follower input tubes (RCA 5879) was  $5 \times 10^{-12}$  A or better,

and the input capacity was about  $2\mu\mu\text{fd}$ . without micropipettes. In the later experiments grid current was minimized, presumably to a value around  $10^{-13}$  A, by tube

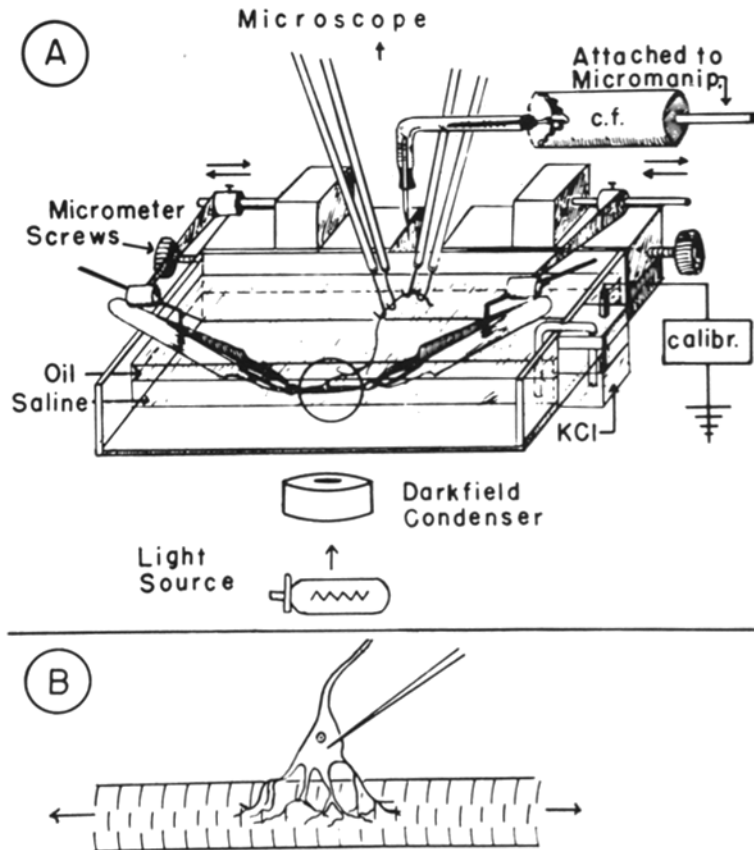

FIG. 1. A, view of experimental set-up. The receptor preparation (in circle) is near the saline-paraffin interface, its nerve lifted into oil and placed on stimulating-recording electrodes. Fine tipped forceps hold the ends of the receptor muscle and are attached through ball and socket joints to a micrometer screw-operated "stretcher." Cf. cathode follower.

B, schematic presentation of a nerve cell making contact with a receptor muscle strand, seen through the dissecting microscope. Capillary electrode in place.

selection and by adjusting the cathode bias. The Ringer solution which just covered the cell, held at the fluid-paraffin interface, served as an indifferent lead. It is thought that capillaries with a relatively long and gradual taper are best suited for many of the present experiments. Their flexibility may prevent breakage of tips and undue injury, although penetration of cells is less difficult with short and sharp tapered

electrodes. Thus, impaled cells could be stretched by a manually operated micrometer adjustment, both ends of the preparation being pulled simultaneously, with the nerve cell in the middle under microscopic observation. It was attempted to prevent excessive pull and movement in either direction by adjusting the stretching so as to keep the nerve cell centered in the visual field. During stimulation of the motor nerves rapid twitches or slow shortening occurred, pulling the impaled cell and the long thin shafted electrode along, as also occurs during intracellular recording of twitching muscle fibers. On the whole it was surprising that the intracellular lead did not get dislodged more frequently or injure the neuron appreciably, undoubtedly due to the strong connective tissue which surrounds the cells. A good check on the validity of many of the results obtained with intracellular leads was the fact that they could be reproduced with extracellular electrodes.

#### *Impalement of Cells*

A darkfield photomicrograph of an unstained single nerve cell from the lateral eighth thoracic receptor of a lobster is shown in Fig. 2 A. The outlines of the cell body include the surrounding connective tissue capsule. In all suitable preparations the cell borders are well seen and especially the nucleus provides a good target for guiding the tip of the microelectrode into a central portion of the cell. The dendritic processes are usually obscured by the connective tissue-muscle substance into which they insert. In some preparations, however, for instance in Fig. 2 A, the cell body does not lie quite close to the receptor muscle and the thicker portions of the dendrites can occasionally be followed for a varying distance (100 to 200  $\mu$  in the lobster, less in the crayfish) as they leave the cell body. Differences between various nerve cells have already been well described by Alexandrowicz (2, 3) and more recently by Florey and Florey (18).

Fig. 2 B illustrates a smaller cell from the eighth lateral thoracic receptor of the crayfish. It was taken in a fresh state, placed on a slide, covered with a thin cover-glass, and photographed with a phase contrast microscope. After a short period the cell generally deteriorates visibly, becoming more granular. The shape of the cell in Fig. 2 B is distorted, somewhat flattened out since phase photography is thereby greatly improved. Four groups of dendrites are partially seen. Analogous phase pictures of lobster nerve cells were generally not successful, presumably due to their greater thickness and due to the unavoidable loose superficial connective tissue strands which obscured the cells. The nerve axon approaching the cell from the right is presumably an inhibitory fiber which forms synapses on the dendrites (31). In Fig. 2 B stray connective tissue around the sensory axon and the cell body was blocked out on the print in order to increase contrast. Much detail and outline seen during inspection are lost in the photograph by focussing on one plane in a relatively thick preparation.

In some cells, particularly in crayfish, microelectrodes penetrated quite readily into the cell interior, using the usual criterion of sudden potential drop as the electrode was advanced. In other cells the surface was dimpled and obvious pressure was exerted in order to penetrate. Even so it was frequently impossible to impale some of the cells without electrode breakage and injury. It is thought that the reason for such failures lies in the unsuitable shape of some of the electrode tips, in differences

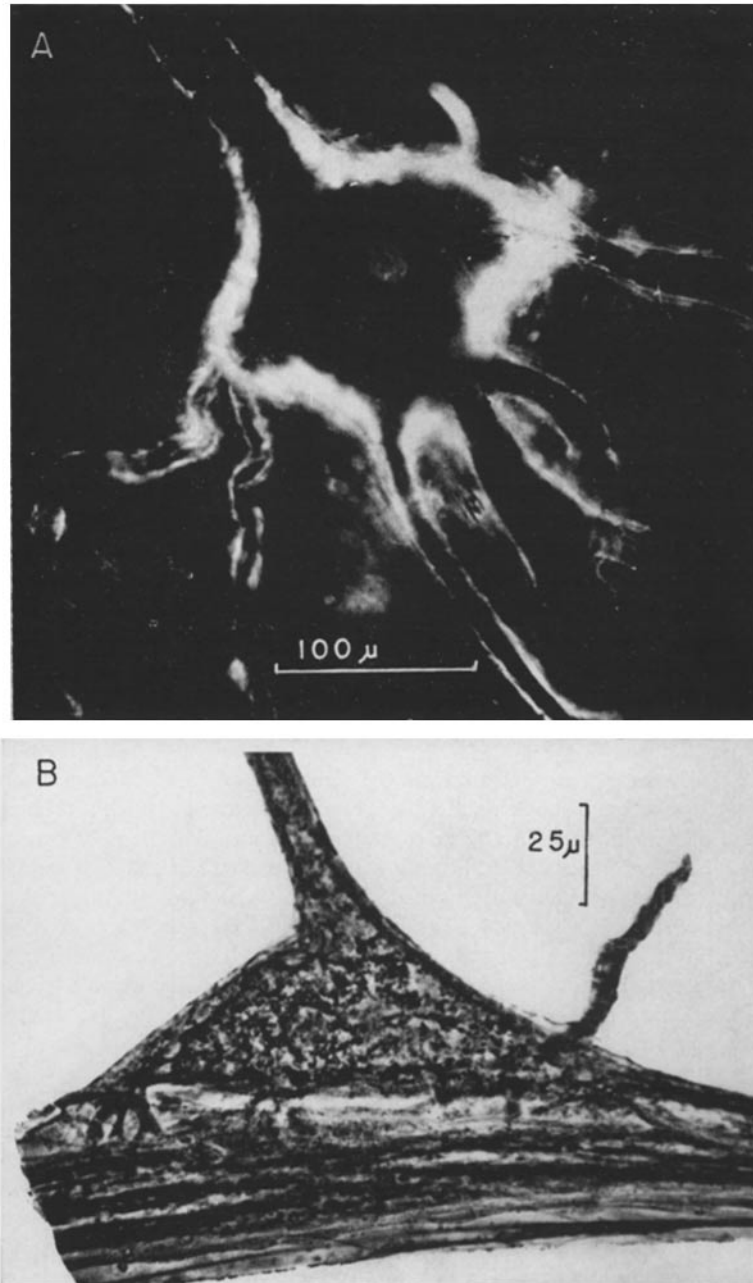

FIG. 2

of connective tissue covering of cells (especially in the lobster), and in the selection of particular regions of cells. Occasionally impalement seemed unsatisfactory as judged by low resting potentials and spike size. This, however, was frequently transient, cells recovering over a period of several minutes following penetration. Once suitably set up, nerve cells did not seem to deteriorate appreciably for several hours after successful penetration, maintaining their action and resting potential size.

*“Softening” of Connective Tissue.*—The difficulties of impaling cells, most frequent in the lobster, could be overcome by the use of various enzymes. The most successful were crystalline chymotrypsin or trypsin (Armour). They were made up in concentrations of 0.2 to 1.0 mg./cc. and applied to the tissues. After about 20 minutes' action at room temperature the tissues became “soft” and “sticky,” easily determined by slightly pulling on the connective tissues. While microelectrodes penetrated readily into cells under such conditions, other complications frequently arose. The muscle strands tore easily, slipping from the tendinous insertions on moderate stretch was frequent, and stretch deformation of the sensory terminals by extension was made difficult, apparently due to the effective absence of supporting structures around the terminals. Furthermore the cells tended to become slightly opaque, presumably a result of changes in surrounding connective tissue strands. Their function, however, was not impaired as judged by tests on the resting and action potentials. Whenever possible, the use of enzyme preparations was avoided. Chymotrypsin has been used successfully by Tobias and Bryant (39) on lobster axons.<sup>1</sup>

## RESULTS

### A. CHANGES IN THE NERVE CELL SOMA DURING STRETCH OF DENDRITIC PROCESSES

#### *Transmission from Dendrites to Soma; Subthreshold Graded Effects*

Recordings from afferent axons of stretch receptors have shown that some of the sensory neurons continue to discharge for the duration of stretch, while

<sup>1</sup>We are indebted to Dr. Julian M. Tobias for suggesting this enzyme and to Armour & Co. for supplying several enzyme preparations.

---

FIG. 2. A, view of an unstrained receptor cell of Alexandrowicz under darkfield illumination. Lateral receptor of the eighth thoracic segment in the lobster. Six large dendrites emerge from the cell body (nucleus a little off center to right) with their distal portions invisible, embedded in the tissue of the receptor muscle strand. The axon is seen on the opposite side from the dendrites.

B, phase contrast photomicrograph of an unstained fresh receptor cell in the eighth lateral thoracic receptor of a crayfish. Four groups of dendrites are seen to insert into the fine receptor muscle strand (striation not seen here). A nerve, presumably the inhibitory axon (see reference 31), approaches the cell from the right. Fine connective tissue strands surrounding the neuron and the receptor muscle have been blocked out photographically in order to obtain a white background and better contrast.

others adapt quickly (40). The functional differentiation of the two neuron types has proved of advantage in analyzing many processes of excitation spread. Before dealing with the specific neuron properties, some of the essential common attributes will be presented.

If one stretches a completely relaxed receptor muscle, the resting potential of 70 to 80 mv. of its impaled sensory nerve cell will be reduced. These changes and their time course were frequently measured directly by an intracellular electrode inserted into the cell soma. Similar results could be obtained if one recorded with one external electrode from the sensory axon where it emerged from the cell body, while the other electrode recorded further centrally along the course of the afferent fiber. This method was simple and avoided the injuries which can occur when impaled cells are stretched; it provided, however, only the time course of resting potential changes and did not measure directly the magnitude of the membrane potential fluctuations.

Fig. 3 A represents the subthreshold membrane potential change recorded with an intracellular lead in a slowly adapting nerve cell of the third abdominal segment. A completely slack receptor muscle was gradually extended without causing sensory discharges and held for 2.5 sec. before it was relaxed again to its original length. The membrane potential of 75 mv. was reduced by 6 to 7 mv. for the duration of stretch. The extent of depolarization was graded, dependent on the amount of stretch, and it also appeared to follow the time course of extension. The fine rapid irregularities in the slow potentials were due to vibration in the stretcher. These subthreshold changes were difficult to obtain in some of the slow cells which discharged propagated impulses quite readily even with minute stretch. Some preparations, in fact, fired "spontaneously." It is thought that the preparations in which subthreshold effects (Fig. 3 A) can be obtained are not "fatigued" or otherwise damaged, but rather are the more normal ones. In undissected receptors, left *in situ*, a certain amount of stretch could generally be applied (by bending the tail) without causing discharges. If conduction was blocked by 0.05 to 0.1 per cent novocaine the maintained depolarization alone, uncomplicated by impulses, was easily seen for the duration of light or strong stretch. Such changes are shown in Fig. 3 B recorded with extracellular electrodes (note calibration, smaller potential) using d. c. amplifiers. The latter results resemble those obtained by Katz (29) from sensory terminals of anesthetized muscle spindles.

The fast receptor cell needs greater stretch than the slowly adapting one before discharges are set up, and subthreshold phenomena could always be recorded. Graded depolarizations up to 15 to 22 mv., depending on the amount of stretch, are the rule. An example of a relatively weak stretch, while recording with intracellular leads, is given in Fig. 3 C. A decline in the depolarization level during the initial period of maintained stretch to a lower maintained value was always seen and appears to correspond to the "dynamic" and "static" phases of spindle potentials (29).



The available evidence shows that the dendrites of the nerve cell are primarily affected by stretch and the remainder of the cell becomes involved secondarily. This is already suggested by the anatomical arrangement (Figs. 1

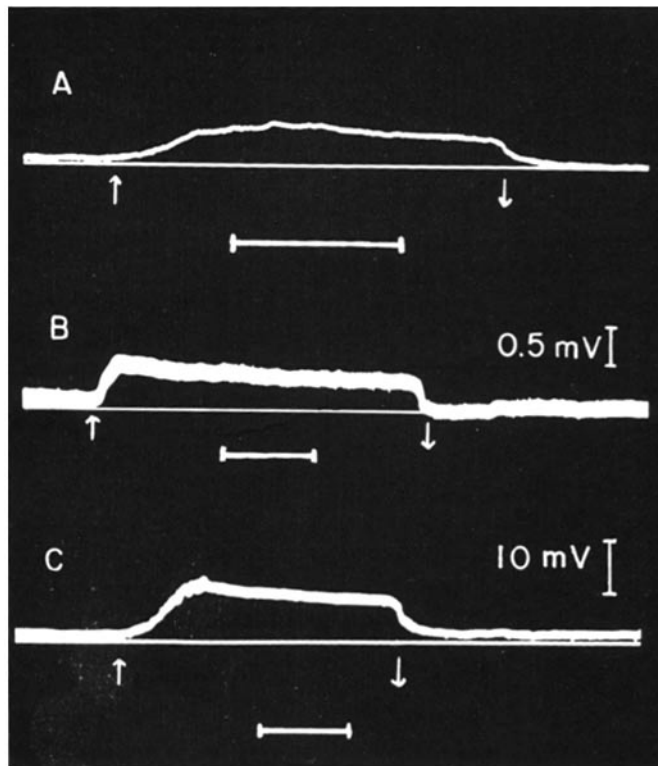

FIG. 3. Membrane potential changes during stretch in the absence of sensory discharges. A, intracellular record from the cell body of a slowly adapting cell in the third abdominal segment of the crayfish. Stretch and relaxation marked by arrows. Resting potential of 75 mv. reduced by 6 to 7 mv. for the duration of stretch. B, stretch applied to slow cell for almost 4 seconds during conduction block with 0.1 per cent novocaine. Extracellular recording. Note similarity to A (slower camera speed). C, impaled fast adapting cell, stretched for 3 sec. Potential calibration same for A and C. Time calibration 1 sec. in all records. Note the initial decline of the potentials during maintained stretch.

and 2) since only the terminal nerve filaments are intimately linked to the stretched muscle elements and therefore they are expected to be principally exposed to stretch deformation during extension. It is also possible, however, that the potential changes are set up by movement of the relatively larger cylindrical shafts of the dendrites between the region where they emerge from

the cell body and enter the receptor muscle. This is excluded since comparable resting potential changes do not occur if one moves an impaled nerve cell without appreciably stretching its receptor muscle strand. This is done best if the preparation floats at the fluid-oil interface and a firmly lodged microelectrode is raised and lowered or moved sideways, carrying the cell with it. In this test, with the membrane potential simultaneously recorded, no appreciable potential fluctuations need to occur. In other tests the cell body lying on a glass plate was actually deformed by pressing against it with a micromanipulator-controlled fine glass tip and, provided that no obvious injury was caused, the cell remained quiescent. Further, moderate stretch of the receptor axons in different directions, while visibly pulling, bending, or deforming the cell does not set up sensory discharges or appreciable depolarization, as recorded by leads on the axon near the cell body.

It is concluded from these experiments that the peripheral portions of dendrites embedded in the receptor muscle, are specifically sensitive to stretch which causes them to depolarize. At the same time it is realized that adequate pressure does depolarize neurons anywhere and can cause them to discharge. Although this line of evidence seems sufficient, particularly in view of analogous findings in the frog spindle sensory nerve fibers (29), additional strong evidence derives from inhibitory synaptic action which is confined to the terminal network (31). The primary depolarization of the terminals appears to be transmitted electrotonically to the nerve cell which follows the fluctuations impressed upon it from its processes. In fact, if one moves the active external lead away from the nerve cell soma, or inserts the microelectrode further centrally from the cell body, it can be shown that the changes caused by stretch also spread decrementally several millimeters centrally into the sensory axon. Such a finding is to be expected from numerous other studies on the nervous system dealing with electrotonic spread. The potential change within the terminal region will be called the "generator potential" in line with earlier suggestions by Granit (20) who used this term in studies of the electroretinogram, trying to localize the primary event set up by a stimulus and leading to nerve discharges. The generator potential in turn gives rise to the *secondary* electrotonically conducted potentials which are detected in the cell soma and further centrally. Stronger stretch thus appears to set up a larger generator potential, with the cell body following the change. Again, further evidence of the direct relationship between the generator and the secondary potentials (also called prepotentials, if they set up impulses) is derived from inhibitory action which is confined to the dendrites. Inhibitory impulses, by "turning off" the generator abolish or reduce the non-conducted potentials in the cell soma in the presence of stretch. The latter observation and detailed analysis of events in the dendrites (16, 31) exclude the assumption that the generator action may be secondary to stretch depolarization of the receptor muscle elements.

The experiments on subthreshold excitation of stretch receptor cells show that the generator potential within the dendrites and its secondary electrotonic potential in the adjoining cell soma persist for the duration of stretch. That these events within the dendrites are not propagated in all-or-none fashion is shown not only by their finely graded nature but also by their persistence when conduction is blocked by novocaine (Fig. 3 B). The receptor cells thus possess a mechanism which permits the dendrites to "set" and adjust the membrane potential, and thereby the excitability of the cell over a considerable range.

Since the subthreshold graded potentials are measured in the cell body and not at their site of origin, the actual amount of stretch depolarization in the dendritic terminals is not known. A spatial decrement along the dendrites has to be assumed, the extent being determined by the electrical characteristics of the cell body-dendrite system. One may tentatively assume that the space constant found in *Carcinus* axons by Hodgkin and Rushton (27) and Hodgkin (24) is similar to that of the present cells. If allowance is made for the smaller diameters of dendrites, an electrotonic potential may decay to about half in 0.5 mm. The subthreshold potentials recorded in the soma, but arising in the distal dendrite portions, may be reduced by 20 to 80 per cent. The values should vary with cell size and anatomical configuration and the tentative nature of the estimate must be emphasized.

#### *Site of Initiation of Conducted Impulses*

If the soma of a nerve cell is impaled while its receptor muscle is completely relaxed it generally has a resting potential of 70 to 80 mv., which shows no significant "spontaneous" fluctuations (above 1 mv.). By appropriate stretch the resting potential may be reduced to a new steady level. At a critical membrane depolarization, generally between 8 and 12 mv. in slowly adapting cells, a propagated all-or-none nerve impulse is set up. In fast cells the critical membrane potential for a conducted discharge is usually between 18 and 22 mv., but may be as high as 25 mv. The propagated impulse overshoots the zero membrane potential by about 20 mv. in uninjured fresh preparations. The repolarization phase brings the action potential back 5 to 10 mv. *below* the point at which the impulse arose. This is illustrated in Fig. 4 A where a slow cell was stretched and relaxed twice in succession, resulting in 1 and 5 impulses after an initial depolarization of about 12 mv. During the first stretch the tension on the preparation was actually slightly released after the impulse and the same was done in the second stretch after the fifth impulse, just cutting off the prepotential before it was able to start a further discharge (see below). Adequate steady stretch of a normal slowly adapting cell always caused a well maintained rhythmic discharge series following an initial transient acceleration. Each succeeding impulse in such a train is preceded by a new depolarization which reaches a critical level similar to the depolarization which sets off the first discharge of the series. A closer examination of these "prepotentials" and

their relationship to the propagated impulses can be made in Fig. 4 B at high amplification and faster sweep speed. A cell was stretched slightly above its firing level, each impulse triggering the oscilloscope sweep thus superimposing

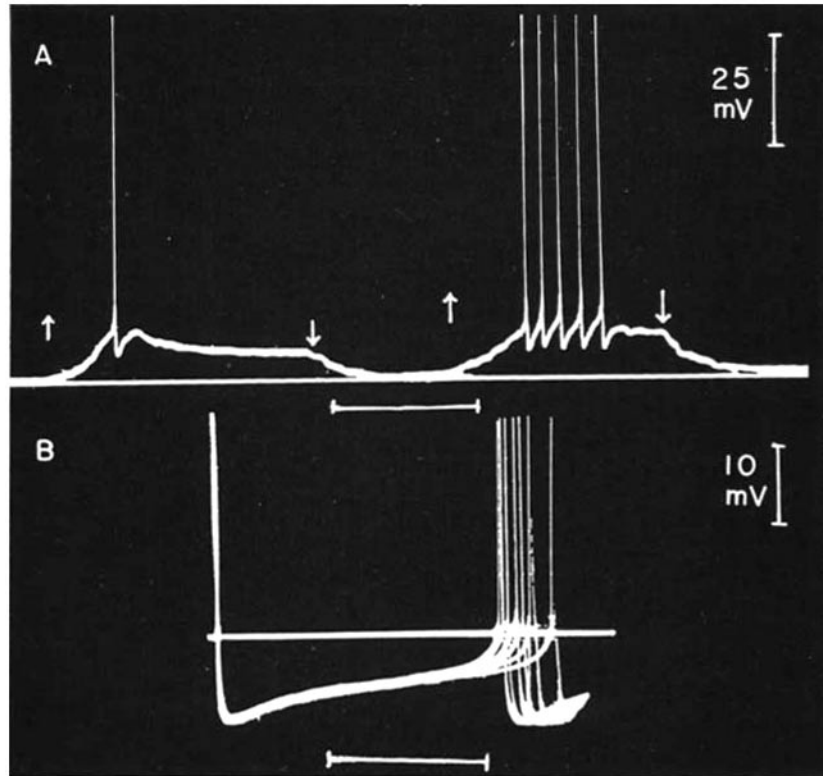

FIG. 4. Intracellular recording from a slow cell, eighth lateral thoracic receptor. A, receptor stretched and relaxed twice in succession. First stretch sets up one conducted soma impulse, while second stretch causes five discharges after an initial depolarization of 12 mv. Impulse peaks 80 mv. Time, 1 sec. B, slow cell discharging at about 5/sec., each sweep triggered by a sensory impulse, thereby superimposing the succeeding prepotentials. Higher amplification, only lower portions of impulses are seen. The difference between impulse intervals reflects fluctuations in frequency. Second beam set near firing level of cell. Time 0.1 sec. (see text).

a variable number of discharges together with their prepotentials. Only the lower portions of the impulses are seen; the second beam is set near the firing point. The differences between the intervals of impulses reflect the irregularity of discharge near threshold stretch which in this instance fluctuated around 5/sec. A highly regular sequence is seen at greater stretch (below, Fig. 6 B).

The observations of Fig. 4 apply also to fast adapting cells, except for the

higher membrane potential at which propagated impulses arise and the much more rapid adaptation of the discharge rate (see below). At first sight one may then conclude that the "firing level" of the two cell types differs by about 10 mv. This problem of cell threshold for conduction will be discussed here although much of the evidence will be presented later. The above conclusion of varying thresholds would be based on the assumption that the conducted impulses arise in the cell body near the recording electrode and that the prepotentials indicate the true critical impulse threshold for the soma of the fast and slow cells. As an alternative explanation one may assume that depolarization of the terminals, *i.e.* the generator potential, sets up in one or more dendrites all-or-none impulses which propagate through the cell body in which the capillary electrode is located. In the latter case the true threshold for conducted impulses could be obtained by recording from the dendrites. There the critical membrane potential for conducted impulses should be higher than is indicated in our records because the potential has diminished during the electrotonic spread to the recording electrode. An analogous problem has been seen and worked out clearly in single *Carcinus* fibers when recording activity arising at different distances from a stimulation cathode (24). Therefore, if conducted impulses arose in dendrites one would measure an apparently low firing level in the cell body. It is suspected that the differences in the thresholds which are recorded between fast and slow cells are due to the impulses starting at varying distances from the intracellular lead. These statements are mainly based on the following observations: (a) antidromic impulses which are blocked at the soma-axon boundary region can cause in the cell body a depolarization of about 20 mv. or more before they cause a full invasion of the cell (for details see reference 16, Figs. 5 and 6); (b) if the threshold of the cell soma was studied in the above manner it was similar in fast and slow cells and appeared to be around 20–25 mv. Apart from passing current through the cell by internal electrodes and measuring the threshold directly, the blocked antidromic impulse is likely to provide a better method for measuring the firing level than the stretch depolarization of Fig. 4.

Since the firing level in fast cells appears similar with stretch excitation and with the antidromic impulse block technique it is concluded that in fast cells the generator potential spreads to the cell body and initiates impulses either there or quite nearby around the confluence of the dendrites. The relatively short dendrite length in fast cells makes this view plausible apart from the likelihood that the progressively expanding surface of dendrites towards the cell body, reducing current density, favors current spread without setting up conducted impulses. In the slow cells, however, with their relatively long dendrites, the impulses are expected to arise at a distance from the cell body. Since the differences in cells and their intimate geometry are not sufficiently known one cannot draw more definite conclusions.

It is certainly expected, that conditions for impulse initiation vary greatly

in different cells. For instance, Florey and Florey (18) describe "dendrites" which may be rather long and may on occasions emerge from the axon and not from the cell soma. The N cells of Alexandrowicz (3), providing long dendrites, may usefully be explored. No uniform scheme for ascertaining the site of impulse initiation seems applicable at present. In the subsequent descriptions the term firing level or threshold will be used *descriptively*, as measured by the electrode in the cell body.

#### *Characteristics of Slowly Adapting Cells*

These neurons resemble in much detail the sensory nerves of the vertebrate muscle spindle and they show a remarkable tendency for sustained rhythmic discharge. It was shown above that the threshold for neuron discharge lies around a soma depolarization level of 8 to 12 mv., starting at a resting potential of 70 to 80 mv. in a relaxed cell. As will be discussed elsewhere in connection with the "positive afterpotential," there is always some degree of uncertainty about the "true" resting potential and the resting or relaxed state in slow cells. However, in individual cells the firing level remains constant (within about 2 mv.) over long periods and changes only when "fatigue" or damage intervenes (Fig. 8). The first result of a maintained stretch increment above threshold is an increase in the discharge frequency which is best measured during the static phase (29), a short period after increasing the stretch, when the impulse rates have become remarkably constant. The firing level at first remains unchanged and only the rate of rise of the prepotential is increased and thus the cell is excited at a similar threshold over a considerable range of stretch. For instance in Fig. 5 A an impaled slow cell gave five irregular discharges during the first 2.5 sec. of initial near threshold stretch (between first two arrows), but increased its rate up to 12 to 14/sec. when additional stretch was applied (at second arrow). The changes in prepotential slopes are apparent while the discharge thresholds are not appreciably changed as seen from the dotted line which is drawn in at 12 mv. below the "resting" potential.

In Fig. 5 B, stretching was gradually continued well beyond threshold between the first arrow and the straight line. As the discharge rate increases above 13 to 15/sec. to approximately 50/sec., the firing level clearly rises; *i.e.*, the critical depolarization at which the impulse takes off is higher at increased frequencies (note the transition from the thicker prepotential to the finer impulse trace). This remains so when the stretch is maintained at such high levels causing regular discharges at 30/sec. in the right hand section of Fig. 5 B. In the middle section of this illustration (dark gap) several seconds of steady discharge were omitted. During strong stretch the repolarization phase between individual impulses becomes less complete, resulting in a base line shift towards greater depolarization for the duration of stretch.

If such a preparation is relaxed, however, the original resting potential is restored after a transient hyperpolarization phase (see below, "off" effect).

The constancy of the firing level as indicated in Fig. 5 A during moderate stretch is more clearly seen in Fig. 6 A and 6 B at fast speeds and high amplification, when several exposures were superimposed, each sweep being triggered by a sensory discharge. In Fig. 6 A the stretch was near threshold and

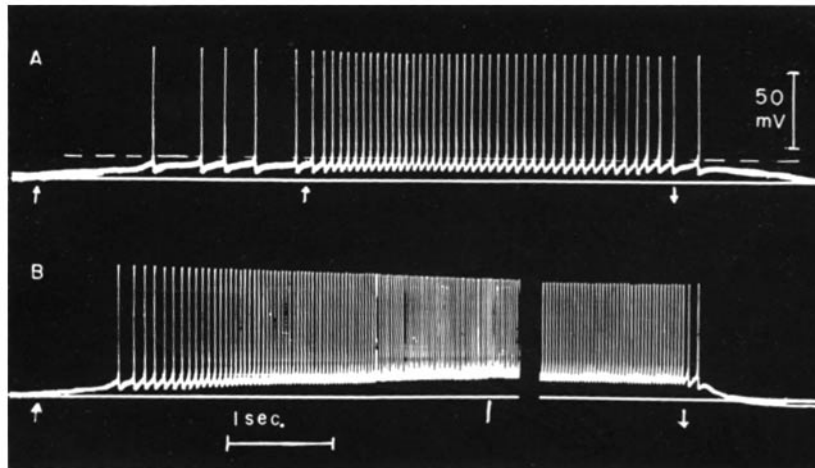

FIG. 5. A, slow cell impaled and stretched just above threshold, setting up five irregular discharges at a depolarization threshold of 12 mv. At second arrow additional stretch increased discharge rate to 12 to 14/sec. Firing level, marked by broken line remained almost constant, while rate of prepotential rise increased. B, same cell, stretch was gradually increased over 4 sec. between first arrow and straight line and then held constant. Note rise in firing level as frequency increases while spike height declines by several millivolts (see also Fig. 9). The discharge is regular (30/sec.) during maintained stretch. Several seconds of rhythmic discharge not shown (dark gap). Relaxation is followed by small transient phase of hyperpolarization (see Fig. 10).

the discharge rate about 5/sec. In Fig. 6 B at a higher steady stretch the regular discharge rate, as measured by the interval between the triggering and subsequent discharges, was 16/sec. There was no appreciable change in the inflection point between prepotential and the impulse, well seen from the relationship to the reference line which was the same in all the records of this illustration. A and B of Fig. 6 therefore compare well with the moving film record of Fig. 5 A taken at low amplification on the same cell. In Fig. 6 C a steady discharge at 40/sec. is shown. The firing level has risen 7 to 8 mv. above the reference line and the impulses do not repolarize to the same

value as at lower stretch. Again, a good comparison can be made with Fig. 5 B, taken at lower amplification. A tracing of selected records from the same slow cell is presented in Fig. 6 D, showing superimposed the changes in firing threshold, in the rate of rise of prepotentials, and in the recovery phase of

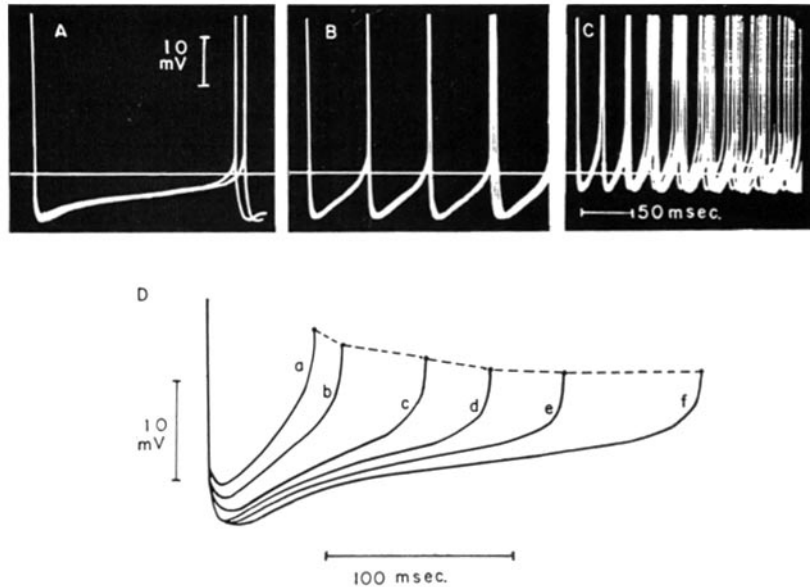

FIG. 6. Firing threshold at different levels of stretch. Slow cell impaled, resting potential near 70 mv., spike peaks about 80 mv. not seen at this high amplification. Sweeps triggered by sensory impulses. A, near threshold stretch, discharge frequency about 5/sec. B, greater steady stretch sets up more regularly maintained activity at 16/sec. Second beam same position in all records, several millivolts below firing level (point of inflection between prepotential and spikes). C, stretch further increased, discharge rate 40/sec. Note similar firing level in A and B, while in C it is about 7 mv. higher. D, tracing of selected records at six different levels of stretch. Dotted line connects the threshold values at which the cell discharges. Between *f* and *a* the discharge rate rises from 4/sec. to 20/sec., while the firing level increases by 4 mv. Note changes in rate of rise of prepotential slope. At higher tensions in C and in *Dc, b, a*, the impulse repolarization phase is less complete (see text).

impulses during different degrees of stretch. Discharge rates are about 4/sec. in Fig. 6 *Df* and 20/sec. in *Da*. The shift in the discharge threshold between these two frequencies was about 4 to 5 mv., the intermediate values are indicated by the dotted line. Such measurements were repeated many times and gave consistent results.

In interpreting these results it will be assumed that, just as in the sub-



threshold phenomena, stretch sets up in the slow cell terminals a generator potential which in turn spreads electrotonically and sets up impulses in the dendrites at a critical level of depolarization. It is the secondary electrotonic potential which is largely wiped out during the impulse (see below) and develops once more immediately after the spike. Accordingly, the prepotentials show a parallel behavior to the subthreshold potentials (Fig. 3) and to the potential which sets up the first impulse in a series. These potentials are all finely graded with stretch and apparently are an expression of the generator process within the fine dendritic branches. Since the soma threshold varies only little during weak receptor extension, it is the slope of the prepotential which determines the discharge frequency at such stretches, reaching the critical level at a varying rate. Over this range of stretch a direct relationship may be sought between the amount of stretch deformation (or receptor elongation) and the amount of generator potential. Excessive stretch presumably becomes less effective due to a threshold rise at high frequencies, limits being set by refractoriness and recovery processes and eventually a cut-off point is reached at a critical depolarization (Fig. 9).

#### *Activity in Fast Adapting Neurons*

If the receptor muscle of a fast adapting cell is stretched, similar membrane changes take place as in the slowly adapting neuron. The two obvious differences pointed out above are: (a) a greater extension is necessary for discharges to be set up, and (b) the discharges stop, generally within 1 minute, depending on the amount of stretch (*cf.* also reference 40). Fig. 7 shows several representative features of fast cell behavior during moderate stretch. In Fig. 7 A an impaled cell was slowly and progressively stretched for 2 sec., its resting potential of 70 mv. was reduced by more than 20 mv. when three impulses were set up. A second small additional stretch (arrow 2) which was then steadily maintained caused only six discharges which were followed by a gradual decline of the cell depolarization to about 7 mv. in Fig. 7 B (several seconds of the record were cut out between A and B). A small rapid stretch (arrow 3) applied to this extended but quiescent cell once more reduced the resting potential to a similar level as before, starting a longer train of impulses which again decreased in frequency and stopped when the depolarization fell below a critical level. At arrow 4 the preparation was completely relaxed. All the impulses reached a peak value of 80 mv. The dotted line drawn at 25 mv. depolarization marks the approximate firing level of the cell. All the normal slow cells which have been seen had a lower firing threshold. In Fig. 7 C, D. c. recording was done with one external electrode near a fast adapting cell, the other further centrally near the cut end of its sensory axon. The records are essentially similar to those obtained with intracellular leads, but the potentials are much smaller. Again, the decline of

depolarization during maintained stretch and the similarity of firing threshold during reextension are obvious.

It therefore appears that at least one factor contributing to fast adaptation is the relative inability of the cell to maintain a reduced potential level during prolonged stretch. It was found that in well functioning preparations the firing threshold stays reasonably constant. No accurate quantitative measurements were made, but the rate of rise of stretch which could be varied between 0.1 and 10 sec. did not appreciably affect (within several millivolts)

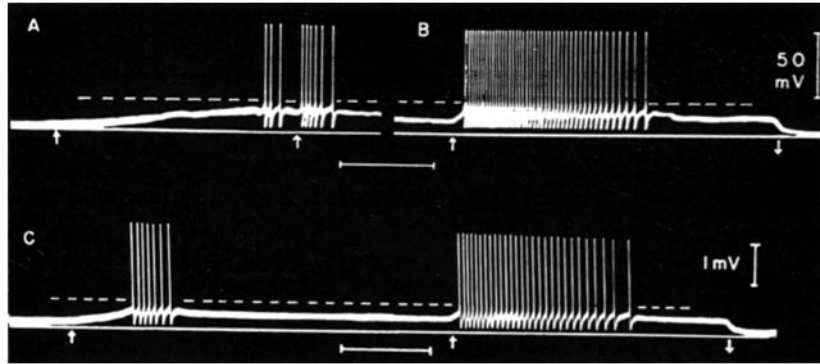

FIG. 7. A, adaptation of impaled fast cell in the eighth medial thoracic receptor during maintained stretch. Slow stretch for about 2 sec. sets up three impulses at a depolarization threshold near 22 mv. At second arrow additional stretch given and maintained for 4 to 5 seconds. As depolarization drops below 20 mv., discharges stop. Part of record cut out, signalled by gap. B, depolarization fell to 7 mv. when at the third arrow additional stretch was given and maintained. Once more the cell discharges at the previous membrane level. C, fast cell in second abdominal receptor. Extracellular recording, small monophasic potentials. Between arrows 1 and 2 steady stretch applied and further extension added and maintained between arrows 2 and 3. Dotted line drawn slightly above firing levels. Note in both cells the decline of the generator potential below threshold during steady stretch. Time, 1 sec.

the threshold for discharge in "good" preparations. When a cell was fatigued, defined for the present purpose as an inability to give discharge trains longer than a few seconds to a wide range of stretches, the more expected picture of adaptation was obtained. The threshold for discharge became much lower with faster than with slower stretches and a large steady depolarization above the initial firing level, could be maintained during stretch, without setting up afferent activity. In fact, the receptor could be overstretched to the breaking point at a slow rate without firing impulses. An example is shown in Fig. 8 obtained with external leads from a fatigued fast cell. In A four successive stretches to progressively higher levels set up bursts of impulses, each at a somewhat higher threshold than the preceding one (impulses off screen, also

note slow recording speed). In B the same phenomenon (five stretches) is more pronounced, while in Fig. 8 C the stretch was too gradual to set up

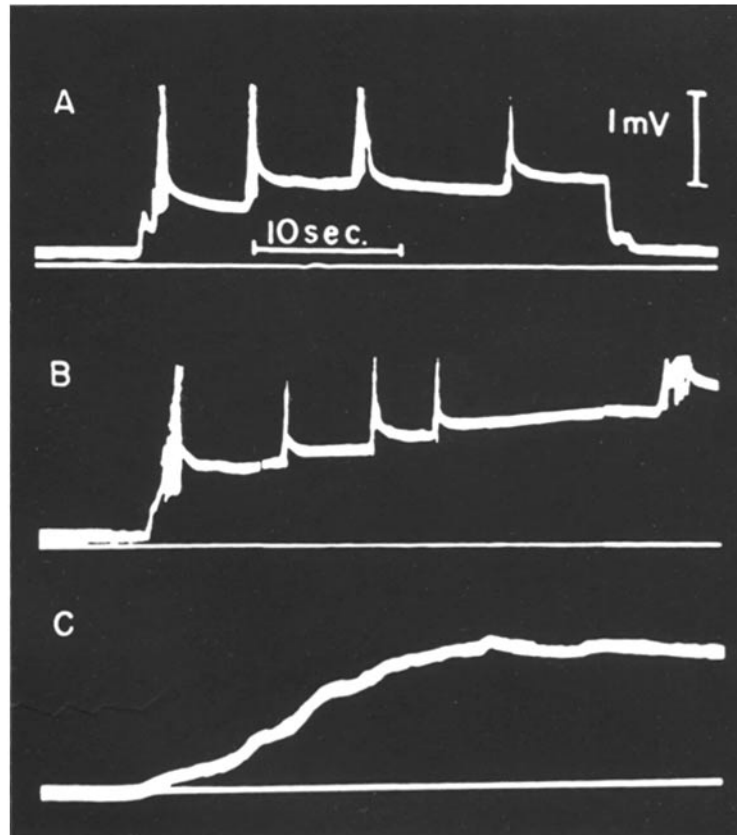

FIG. 8. Adaptation in a fatigued fast receptor cell from the second abdominal segment. Extracellular recordings, impulses made monophasic. A, receptor stretched rapidly to four progressively higher levels and then relaxed. Short bursts of discharges occur at increasing thresholds. Impulse peaks off screen. B, five stretches; threshold has doubled between stretch 1 and 5. C, gradual progressive extension fails to cause discharges, showing influence of rate of stretch.

discharges. These sequences were repeatable and were not obtained merely in rapidly deteriorating preparations.

#### *Overstretch*

This phenomenon was noted by Wiersma, Furshpan, and Florey (40) who found that stretch could be increased in slow receptors until all discharges stopped and activity returned as the preparation was relaxed. It seemed of

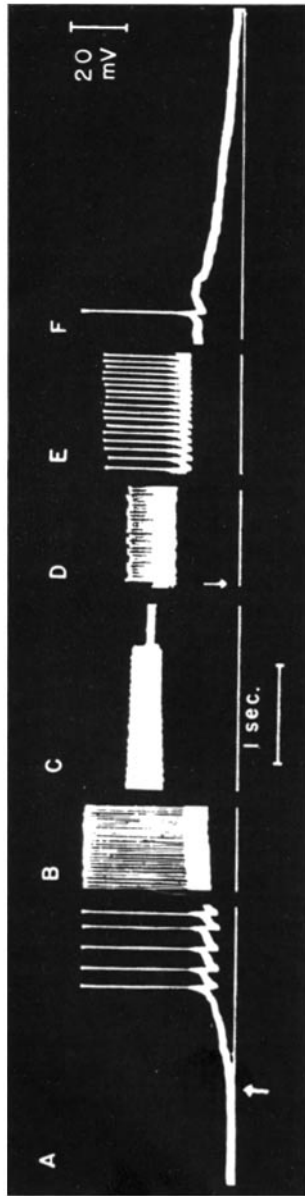

Fig. 9. Overstretch of impaled slow receptor cell in eighth thoracic segment. Continuous stretch progressing over 10 sec. presented in small sections. Between A and B frequency and firing level have increased, but spike peaks are little changed. In C the impulses decrease to about 10 mv. before complete block occurs at a depolarization level around 35 mv. Blocking stretch was maintained for 2 minutes. D, with slight relaxation (arrow) the membrane potential returns into the firing range. E, F, further samples of discharge during stages of relaxation.

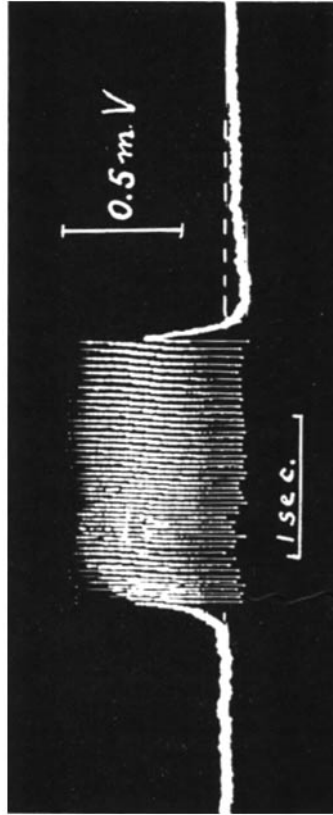

Fig. 10. Off effect in a slow abdominal receptor cell, extracellular d. c. recording. Relaxation is followed by hyperpolarization period (below dotted line), slowly returning to initial relaxed resting potential level. (See also Fig. 5 B.)

interest to follow changes of the cell's resting potential during such events. This is illustrated in Fig. 9 in which gradual progressive stretch was applied to a slow receptor cell. Only segments of the records taken on moving film are shown. In A and B merely frequency and firing level differ; the impulse height, however, declined progressively afterwards and the threshold rose during increasing stretch until the spikes became as low as 10 mv. and around a steady depolarization level of about 35 mv. sudden cessation of the high frequency discharge occurred as seen in Fig. 9 C. This blocking stretch was maintained for 2 minutes (gap after C), when a slight relaxation brought the cell back into the firing range (D). Further gradual relaxation (E and F), eventually restored the original spike peak height. The thresholds for discharge were, however, not similar during stretch and relaxation, apparently due to the long overstretch period. In F, for instance, the last impulse arose at a membrane potential depolarization of over 20 mv. The corresponding depolarization during increasing stretch in B set up sensory impulses at high frequencies. These changes in threshold and "excitability" were, however, reversible and the preparations recovered to a large extent in a few minutes. Thus, in the same cell one could repeatedly pass in and out of the zone of block at similar reduced resting potential levels.

Essentially similar observations can be made on the fast receptor cell. Once overstretched, however, activity may not reappear during slow relaxation. It was also interesting that the steady depolarization was much better maintained than during moderate stretches (Fig. 7).

The reversible block during "overstretch" resembles the well known cathodal block phenomena in nerve. Reduction and disappearance of the impulses may perhaps be related to a decreased sodium permeability during steady depolarization, described by Hodgkin and Huxley (26). The critical region of block is near the soma-axon boundary, as established when leading with one extracellular lead within 1 mm. of the cell and the other about 10 mm. more centrally. Near the critical extension stage some of the small impulses are recorded only by the electrode close to the cell. These apparently die out in the axon near the cell, while others grow up and leave the depolarized region and therefore reach the second electrode. If during that stage the sensory axon is excited antidromically, such impulses will also fail to invade the soma, thus localizing the block to the boundary region between axon and cell body. In addition it becomes clear that during overstretch all propagated activity between dendrites and soma must be absent (Fig 9 C).

During overstretch complicating factors may appear. Frequently the potential does not return to its original level for 0.5 to 1 minute, or the thresholds during subsequent small stretches are changed. It is felt that slippage or injury of the obviously much extended receptor strands may occur and the cell itself may be somewhat damaged. While of general interest, this phe-

nomenon may not be of great physiological importance in the intact animal although it may possibly provide a cut-off mechanism for discharges.

#### *Dynamic and Static Effects during Stretch*

Katz (29) discovered that there are two distinct phases in the potential change sequence during stretch, both arising in sensory terminals: (a) a dynamic phase, during the initial period of stretch and (b) a static phase, during which a lower discharge rate and smaller depolarization of sensory terminals are maintained. These observations also seem to be at the basis of the initial stretch discharge increments originally studied in detail by Matthews (34, 35). No specific study has been made of these phenomena during different controlled rates of stretch. Several experiments indicate, however, that events in the receptor nerve cells are similar to those in the sensory axons of frog spindles. Thus, the slow receptor neuron discharges at a higher rate during the development of stretch and for a short period afterwards, than at a static level. This higher discharge rate appears to be linked with resting potential changes which are markedly higher during and after the initial period of lengthening. The dynamic effect in the slow receptor cell seems, however, to be slower than the corresponding phenomenon in muscle spindles. It must be stated that no adequate checks relating to the actual amount of lengthening of the receptor muscle were made. Further, no estimate is available in respect to the elastic properties of the receptor muscle strands which frequently are quite thin ( $20 \mu$ ) making such procedures technically difficult. The general results do, however, indicate that an analogy to the muscle spindle observations of Katz (29) can be drawn.

#### *The Off Effect*

If the muscle tension in a cat or frog muscle is abruptly reduced to a new steady level, the spindle discharge ceases or falls below the base line rate which will be established at the new tension (34, 35). This off effect has been associated by Katz (29) with a transient positive potential of sensory endings and may be thought of as the converse of the dynamic effect during stretch. Such off effects have been seen in the crayfish and an incidental illustration was given in Fig. 5 B, when recording with intracellular leads. Fig. 10 shows a more striking hyperpolarization phase, obtained with external electrodes, when a stretched slow receptor was relaxed. The amount of positive overshoot depended on the relaxation rate and practically no off effect was seen if stretch was reduced gradually.

The following observations in slow receptors may point to at least one factor operating in the production of the off effect. In some slow cells the stretched receptor muscle was relaxed until the slow cell membrane potential could not be changed by further relaxation. Within a minute or less, however,

relaxation once more produced an increased resting potential, indicating that in the interval some pull had been put on the dendrites. Visual inspection leads one to suspect that relaxed slow muscle strands tend to take up slack and thereby renew some tension on the cell terminal regions. The time course of the cell membrane potential changes may therefore reflect contractile and plastic properties of the tissue surrounding the dendrites, or in series with them. Crushing of the receptor muscle elements did not abolish off effects, but that procedure still left intact the muscle structures around the dendrites. The question which remains unresolved in our experiments is the following: Does the off effect represent a genuine hyperpolarization beyond the resting potential or is it merely a transient return toward the completely relaxed state of the receptor cell?

#### B. CELL POTENTIALS DURING RECEPTOR MUSCLE CONTRACTION

Since stretch causes depolarization of the dendrites, potential changes detected in the soma may be used as good indicators of activity in receptor muscles. In fact, such registration seems to be the physiological function of the receptor cells, namely to serve as biological transducers, converting stretch deformation into nervous events. This built-in mechanoreceptor seems more accurate and sensitive than previous detectors used (30) which measured tension development (down to several milligrams) at the end of the receptor muscles, with many series-elastic elements interposed. In Fig. 11 A and B the intracellular electrode recorded from a relaxed fast adapting nerve cell (third abdominal segment of crayfish) during stimulation of the motor nerves. Several successive sweeps at 4/sec. were superimposed in A. During the relatively slow and transient changes of the resting potential up to 20 mv., lasting about 30 msec., minute contractions were seen through the microscope, but they were not adequate to fire the nerve cell. In Fig. 11 B with stimulation at 10/sec., however, the contractions increased after a few stimuli and reached the cell's threshold and thus the two sensory discharges of 78 mv. resulted. The first impulse in the records following the artefact was due to antidromic invasion of the cell soma, its axon being stimulated together with the motor innervation of the fast bundle. Low frequency antidromic stimulation as used here does not interfere with the cell's ability to detect mechanical changes since its recovery phase is rapid. The absence of after-positivity in a "relaxed" preparation should also be noted (see reference 16).

Fig. 11 C illustrates the acceleration produced in the slow cell discharge by two closely spaced stimuli (10 msec. interval at arrow) to the motor nerve of the slow receptor bundle. At this high amplification only the initial portion of the large impulses together with their prepotentials is seen. The effect is that of a relatively strong and rapid transient pull. Besides the acceleration of discharge rate from a maintained level of 5/sec. to well over 50/sec.

at the height of the effect, the firing level of the cell rises and during that period the repolarization phase between impulses is incomplete (compare with Figs. 5 and 6). As expected, and in contrast to the fast receptor cell,

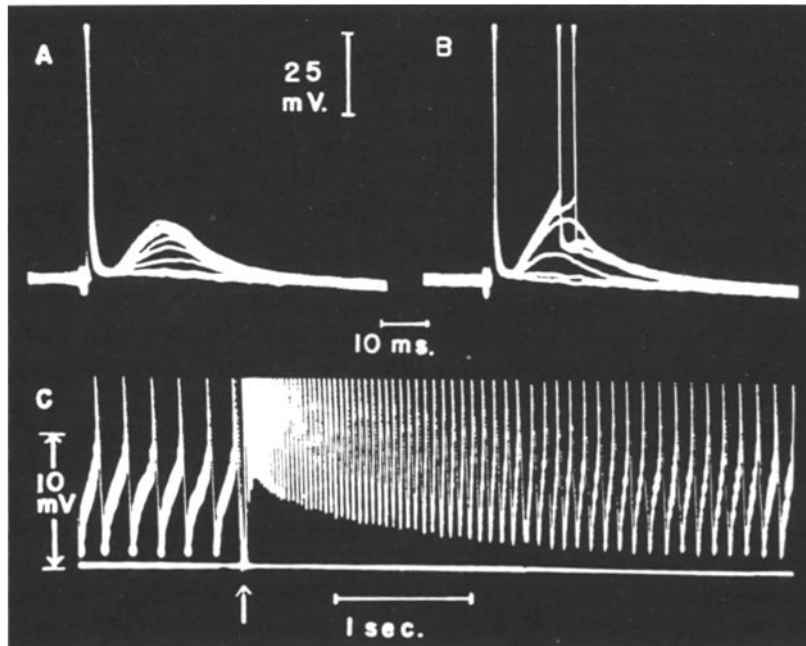

FIG. 11. Cell soma potentials during contraction of receptor muscle. A, intracellular lead from fast receptor cell in the third abdominal segment. Motor stimuli at 4/sec. to the relaxed fast receptor muscle. Successive sweeps superimposed. Minute twitch contractions, increasing during stimulation, cause transient membrane potential reductions, approximately reproducing the time course of tension change. Each stimulus also excites the sensory axon which sends an impulse antidromically into the cell body (first large deflection). B, stimulation rate at 10/sec. Contractions reach threshold for discharge of cell soma and near a 22 mv. depolarization level two impulses are set up. C, acceleration of maintained discharge of 5/sec. produced by two closely spaced motor stimuli (arrow) to the receptor muscle of the slowly adapting cell in the third abdominal segment. Contraction is relatively slow. Only the lower portions of the impulses can be seen at high amplification. Note resemblance of potential sequences to rapidly applied stretches.

the contraction is relatively slow, reflected in the prolonged afferent discharge acceleration (30). Such experiments as above can be done more conveniently with extracellular leads and are useful in determining, for instance, the fusion frequencies of fast receptor muscles. The sensitivity of this nerve cell system



for the detection of "subthreshold" effects was greatly augmented by increasing the initial tension, thus bringing the membrane potential nearer to the firing level. This again is a physiological mechanism which occurs when the tail of the crayfish is flexed. Thus, if a fast receptor is adequately stretched

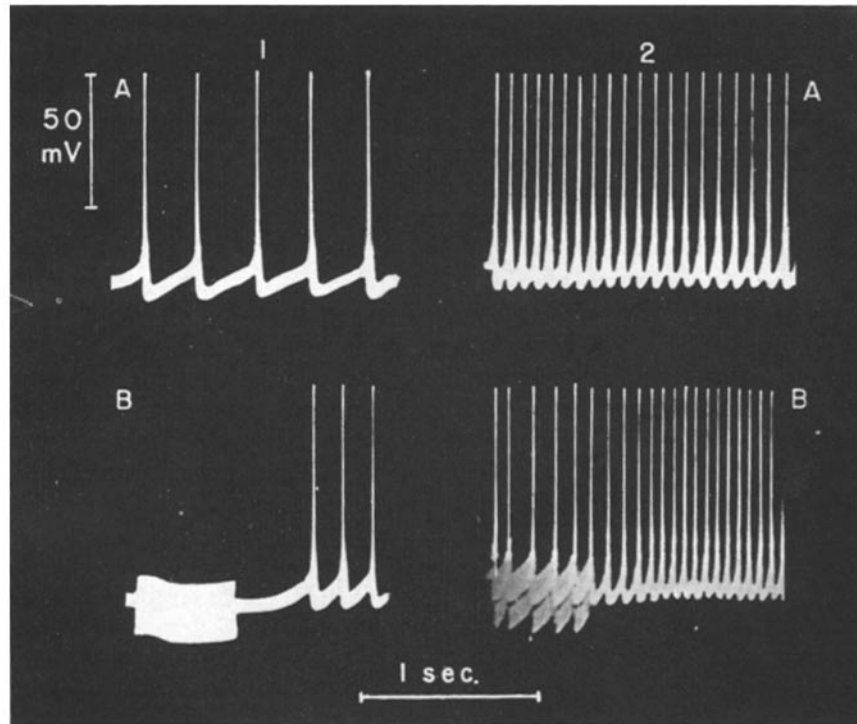

FIG. 12. Cessation of maintained discharge during receptor muscle contraction. 1 A, maintained discharge in slow cell during weak stretch. 1 B, burst of motor stimuli at 100/sec. to slow receptor muscle caused contraction confined to region around the contact area between sensory neuron and muscle elements. Discharge stops and resumes at higher rate during relaxation. 2 A, maintained discharge at greater stretch. 2 B, same stimuli as before reduce discharge rate transiently.

each motor impulse and the contraction which it causes could fire the cell at least once (30).

It should be pointed out that the subthreshold potential changes presumably do not reflect faithfully the time course and extent of tension changes in the receptor muscle. The dynamic phase is expected to exaggerate the small and rapid contractions and presumably distorts its time course. Furthermore, muscle fibers surround the receptor terminals in the crayfish, in con-

trast to the lobster, and no intercalated tendinous portion around the dendrites exists (Fig. 12). Similar contractions in various parts of the long receptor muscle may therefore produce varying results due to unequal transmission of pull to the sensory cells.

Fig. 12 illustrates one of the few preparations in which contraction of the receptor muscle caused slowing or cessation of discharge. Motor nerves of the slow receptor muscle of the second abdominal segment were excited repetitively, setting up slow contractions, largely confined to the middle portion of the receptor where the sensory neuron ends. The contraction was verified by microscopic observation. Motor stimulation at a low level of stretch (Fig. 12, 1 B) caused a transient cessation of the maintained discharge, while the same excitation at a higher initial tension (2 B) merely slowed the regular high impulse frequency (2 A). This behavior of the stretch receptor is analogous to the spindle discharge cessation during contraction of the muscles in which they are embedded. It is clearly a case of "unloading;" *i.e.*, stretch being taken off transiently during contraction (32, 35). Fig. 12 also looks similar to direct neural inhibition of the discharge (31), but that possibility was excluded here. A relatively simple way of causing the unloading effect by motor stimulation was to crush the receptor muscle strand on both sides of the nerve cell. The only remaining contracting area then was immediately under and around the dendrites.

#### DISCUSSION

The principal scheme of excitation presented here depicts a sensory axon with its peripheral cell body which extends dendrites into a fine receptor muscle strand. First of all some kind of definition of "soma" and "dendrite," as used here, seems necessary. Any strict separation of this soma-dendrite complex seems artificial, and in view of the anatomical variability of cells (2, 18), practically impossible. If, however, cells as shown in Fig. 2 are taken as prototypes one may name the portion containing the cell nucleus as soma (or cell body), while the branches spreading out from this center are the dendrites. Such a subdivision of a cell should not imply automatically that the structures have different properties. The relatively large dendritic branches are merely a continuation of the cell body and almost certainly possess similar characteristics. From the present experiments one may assume that the soma and the larger dendritic branches are not specifically sensitive to stretch deformation. The terminal arborization appears to be most intimately linked with the muscle-connective tissue of the receptor strands and this region should be the seat of the generator potential which results from stretch. The primary control thus resides in the distal portion of the dendrites which over a wide range regulate the membrane potential of the more central portions of the cell. Thereby the excitability level of the entire soma-dendrite complex

can be set. This subthreshold regulation is finely graded in the manner of electrotonic changes and, as pointed out before, one cannot assume that properly conducted impulses occur in the dendrites during such maintained light stretches. This also applies for all ranges of stretch if conduction is blocked by novocaine (Fig. 3 B). Stronger stretch and greater reduction of a normal cell's resting potential initiate conducted impulses which may start in the dendrites or in the cell soma.

The behavior of the generator potential and its fluctuations during rhythmic activity of the cell are less simple to analyze. The effects of the generator potential, *i.e.* the secondary electrotonic potentials in the cell soma and in the bigger dendrites, largely collapse during the first conducted impulse. Repolarization takes place to a value about 5 to 10 mv. below the firing level. Immediately afterwards a new prepotential is built up, leading to the subsequent conducted impulse. This new prepotential, dependent in a graded fashion on stretch, is again clearly due to the generator in the terminals (it can also be turned off by inhibition in the terminals). The quick reappearance of the generator action at the end of the soma spike and its incomplete disappearance will be taken as evidence that excitation spread in the dendritic terminals differs from axon conduction and that the generator potential persists to a varying degree during rhythmic activity (16). Thus, changes in the rate of the rhythmic discharge may be regarded as a frequency modulation expressing the intensity of the finely graded generator potential. The following sequence of events is suggested on the basis of current studies: Stretch deformation of dendritic terminal regions  $\rightarrow$  generator potential (persisting to a varying degree for the duration of stretch)  $\rightarrow$  electrotonic spread toward the cell body (prepotential, including 'local' potentials)  $\rightarrow$  dendrite-soma impulse  $\rightarrow$  axon impulse. In those cells in which conduction starts in the soma an impulse will spread not only into the axon but also back into the dendrites.

No good basis for the different behavior of rapidly and slowly adapting cells has been found. According to a widely held view on adaptation one would expect a rise of the membrane threshold for conducted impulses in fast cells during prolonged stretch. This is not supported by the present experiments (Fig. 7) in fresh preparations. It is rather the gradual decline of the generator potential which seems to account adequately for cessation of discharges during maintained stretch. Additional stretch thus restores the generator and sets up impulses near the original threshold level. This process of adding stretches, and thus keeping the fast cell discharging, cannot be carried too far because damage or overstretch results. No technique is available at present of stretching very gradually and smoothly so that a cell depolarization much above 20 mv. could be reached without discharging the cell. At present one may merely state that fast nerve cells are not able to

maintain a sustained generator potential above the firing level in contrast to slow cells. Another difference is the higher discharge threshold of fast cells and their inability to give low frequency discharges. The membrane threshold differences are presumably not real and can be explained if in the slow cells the impulses arise at greater distances from the recording electrode. A partial explanation of slow and fast cell differences in respect to adaptation may be sought in the different structural relationship between the fine dendrites and the tissues surrounding them. The slow cell processes are perhaps more intimately attached to the receptor strands, showing T-shaped terminal branches running alongside the muscle fibers, while the fast cell dendrites have shorter "bushy" endings (18). Possibly there occurs less slippage in slow cells between dendrites and their receptor muscle contact, accounting for the maintained depolarization at moderate stretches. From a few tests it appears that during overstretch both receptors maintain equally well their impressed potential which may fall only gradually over 3 to 5 minutes back into the firing range. It may need such strong stretches to effectively engage the fast cell dendrites. At weak stretches, therefore, the slow cell dendrites may be subject to greater deformation than the fast cell terminals. The visible and great difference in receptor muscle structure itself may be an additional factor contributing to differing discharge properties of fast cells. The slow muscle bundle within the body, with attachments intact, generally looks taut and probably takes up slack even when completely relaxed, thus tending to keep the cell nearer its firing range. The membrane potential of an apparently unstretched slow cell may therefore not be at its true resting level. This may, at least in part, account for the different firing levels of slow cells (8 to 13 mv.) as compared with fast cells (18 to 22 mv.). A fast receptor bundle, when relaxed, looks and remains coiled and slack. It also has less connective tissue covering and appears more transparent. For histological differences see Alexandrowicz (2) and for contractile differences Kuffler (30).

In addition to the "structural" differences there are likely to be more subtle ones and the varying sensitivity of deteriorating fast receptor cells to different rates of stretches (Fig. 8) may point to a physiological differentiation which has not been detected. An electric differentiation of the neurons by testing their reactions to applied currents has not been made and differences in time constants have not been explored (37).

The question of the nature of electromechanical conversion is raised once more in these studies. The terminal regions, the site of the generator potential and of the synaptic contacts, may merely undergo more intense deformation than is usually applied to axons or nerve cells. They may also possess a more specialized surface or molecular arrangement which permits them to respond so sensitively to their "adequate" stimulus, stretch deformation.

Pressure sensitivity as a general property of nerve cells, for instance ventral horn cells (1), has to be studied further. The degree of dendritic depolarization cannot be determined from the present study and presumably exceeds that of the soma.

Graded electrotonic processes and perhaps graded conduction over short distances (16) may play a role in other sense organs, for instance in the neural network of retinal layers in which distances and dendritic branchings are of a similar order as in the terminal portions of the present sensory cells. Graded potentials, dependent on light stimulus intensity, have been found in the primary receptor cells of *Limulus* (23) and of vertebrates (38), (Fitz-Hugh and Kuffler, unpublished data). Furthermore, the present results certainly bring to mind the numerous and widespread observations in the central nervous system, to mention only some of the studies on slow potential changes and their relationship to discharges in the spinal cord (6-8, 14, 33). The more recent observations on motor horn cells during constant current excitation, resemble the sensory cells "driven" by the generator potential (19). To what extent the present nerve cells can be regarded as a model for the incredibly diverse nervous system population remains problematical. The results make it perhaps more probable that other cells exist in the central nervous system which have their main control mechanisms located in the dendrites. For instance, the stretch receptor dendrites may be similar to the paradendritic synaptic regions described by Chang (11) in the cortex. These seem specialized for electrotonic conduction. At the same time the behavior of the receptor cells resembles in much detail that of some of the peripheral nerves or muscles which can be brought to rhythmic activity by constant currents (generator potentials) or drugs (17, 5, 9). The potential sequence of receptor cells under different degrees of stretch is almost parallel to that which occurs at the stimulating cathode in single axons in the crab with constant currents of different strengths (25). In both the level of depolarization with successive impulses remains remarkably constant and varies only little with discharge frequency if excitation is not strong (Figs. 5 and 6). This analogy further supports the view that the dendrites supply the sustained drive for the soma discharge. Essentially, the properties here described fit also the spindle afferent neuron as studied by Katz (29) but with some additional modifications introduced by the cell body near the terminal nerve filaments.

#### SUMMARY

The stretch receptor organs of Alexandrowicz in lobster and crayfish possess **sensory neurons** which have their cell bodies in the periphery. The cell bodies send dendrites into a fine nearby muscle strand and at the opposite pole they give rise to an axon running to the central nervous system. Mech-

anisms of excitation between dendrites, cell soma, and axon have been studied in completely isolated receptor structures with the cell components under visual observation. Two sensory neuron types were investigated, those which adapt rapidly to stretch, the fast cells, and those which adapt slowly, the slow cells.

1. Potentials recorded from the cell body of the neurons with intracellular leads gave resting potentials of 70 to 80 mv. and action potentials which in fresh preparations exceeded the resting potentials by about 10 to 20 mv. In some experiments chymotrypsin or trypsin was used to make cell impalement easier. They did not appreciably alter resting or action potentials.

2. It has been shown that normally excitation starts in the distal portion of dendrites which are depolarized by stretch deformation. The changed potential within the dendritic terminals can persist for the duration of stretch and is called the generator potential. Secondly, by electrotonic spread, the generator potential reduces the resting potential of the nearby cell soma. This excitation spread between dendrites and soma is seen best during subthreshold excitation by relatively small stretches of normal cells. It is also seen during the whole range of receptor stretch in neurons in which nerve conduction has been blocked by an anesthetic. The electrotonic changes in the cells are graded, reflecting the magnitude and rate of rise of stretch, and presumably the changing levels of the generator potential. Thus in the present neurons the resting potential and the excitability level of the cell soma can be set and controlled over a wide range by local events within the dendrites.

3. Whenever stretch reduces the resting membrane potential, measured in the relaxed state in the cell body, by 8 to 12 mv. in slow cells and by 17 to 22 mv. in fast cells, conducted impulses are initiated. It is thought that in slow cells conducted impulses are initiated in the dendrites while in fast cells they arise in the cell body or near to it. In fresh preparations the speed of stretch does not appreciably influence the membrane threshold for discharges, while during developing fatigue the firing level is higher when extension is gradual.

4. Some of the specific neuron characteristics are: Fast receptor cells have a relatively high threshold to stretch. During prolonged stretch the depolarization of the cell soma is not well maintained, presumably due to a decline in the generator potential, resulting in cessation of discharges in less than a minute. This appears to be the basis of the relatively rapid adaptation. A residual subthreshold depolarization can persist for many minutes of stretch. Slow cells which resemble the sensory fibers of vertebrate spindles are excited by weak stretch. Their discharge rate remains remarkably constant for long periods. It is concluded that, once threshold excitation is reached, the generator potential within slow cell dendrites is well maintained for the dura-

tion of stretch. Possible reasons for differences in discharge properties between fast and slow cells are discussed.

5. If stretch of receptor cells is gradually continued above threshold, the discharge frequency first increases over a considerable range without an appreciable change in the firing level for discharges. Beyond that range the membrane threshold for conducted responses of the cell soma rises, the impulses become smaller, and partial conduction in the soma-axon boundary region occurs. At a critical depolarization level which may be maintained for many minutes, all conduction ceases. These overstretch phenomena are reversible and resemble cathodal block.

6. The following general scheme of excitation is proposed: stretch deformation of dendritic terminals → generator potential → electrotonic spread toward the cell soma (prepotential) → dendrite-soma impulse → axon impulse.

7. Following release of stretch a transient hyperpolarization of slow receptor cells was seen. This off effect is influenced by the speed of relaxation.

8. Membrane potential changes recorded in the cell bodies serve as very sensitive detectors of activity within the receptor muscle bundles, indicating the extent and time course of contractile events.

We wish to thank Mr. Albert Goebel and Mr. Robert B. Bosler for their unfailing assistance.

#### REFERENCES

1. Alanis, J., and Matthews, B. H. C., The mechano-receptor properties of central neurons, *J. Physiol.*, 1952, **117**, 59 p.
2. Alexandrowicz, J. S., Muscle receptor organs in the abdomen of *Homarus vulgaris* and *Palinurus vulgaris*, *Quart. J. micr. Sc.*, 1951, **92**, 163.
3. Alexandrowicz, J. S., Receptor elements in the thoracic muscles of *Homarus vulgaris* and *Palinurus vulgaris*, *Quart. J. Micr. Sc.*, 1952, **93**, 315.
4. Alvarez-Buylla, R., and Ramírez de Arellano, J., Local responses in Pacinian corpuscles, *Am. J. Physiol.*, 1953, **172**, 237.
5. Arvanitaki, A., Les variations graduées de la polarisation des systemes excitables, Paris, Hermann et Cie., 1938.
6. Barron, D. H., and Matthews, B. H. C., The interpretation of potential changes in the spinal cord, *J. Physiol.*, 1938, **92**, 276.
7. Bernhard, C. G., The cord dorsum potentials in relation to peripheral source of afferent stimulation, *Cold Spring Harbor Symp. Quant. Biol.*, 1952, **12**, 221.
8. Bremer, F., Some Problems in Neurophysiology, London, The Athlone Press, 1953.
9. Brink, F., Jr., Bronk, D. W., and Larrabee, M. G., Chemical excitation of nerve, *Ann. New York Acad. Sc.*, 1946, **47**, 457.
10. Brock, L. G., Coombs, J. S., and Eccles, J. C., The recording of potentials from motoneurons with an intracellular electrode, *J. Physiol.*, 1952, **117**, 431.
11. Chang, H. T., Cortical neurons with particular reference to the apical dendrites, *Cold Spring Harbor Symp. Quant. Biol.*, 1952, **17**, 189.

12. Cole, W. H., A perfusing solution for the lobster (*Homarus*) heart and the effects of its constituent ions on the heart, *J. Gen. Physiol.*, 1941, **25**, 1.
13. Davis, H., Tasaki, I., and Goldstein, R., The peripheral origin of activity, with reference to the ear, *Cold Spring Harbor Symp. Quant. Biol.*, 1952, **17**, 143.
14. Eccles, J. C., The Neurophysiological Basis of Mind. The Principles of Neurophysiology, The Waynflete Lectures, Oxford at the Clarendon Press, 1953.
15. Eyzaguirre, C., and Kuffler, S. W., Excitation in nerve cells of the lobster stretch receptors, *Biol. Bull.*, 1954, **107**, 310.
16. Eyzaguirre, C., and Kuffler, S. W., Further study of soma, dendrite, and axon excitation in single neurons, *J. Gen. Physiol.*, 1955, **39**, 121.
17. Fessard, A. Propriétés rythmique de la matière vivante, II, Paris, Hermann et Cie., 1936.
18. Florey, E., and Florey, E., Microanatomy of the abdominal stretch receptors of the crayfish (*Astacus fluviatilis* L.), *J. Gen. Physiol.*, 1955, **39**, 69.
19. Fuortes, M. G. F., Direct current stimulation of motoneurones, *J. Physiol.*, 1954, **126**, 494.
20. Granit, R., Sensory Mechanisms of the Retina, London, Oxford University Press, 1947, 412 pp.
21. Gray, J. A. B., and Sato, M., Properties of the receptor potential in Pacinian corpuscles, *J. Physiol.*, 1953, **122**, 610.
22. Van Harreveld, A., A physiological solution for fresh water crustaceans, *Proc. Soc. Exp. Biol. and Med.*, 1936, **34**, 428.
23. Hartline, H. K., Wagner, H. G., and MacNichol, E. F., Jr., The peripheral origin of nervous activity in the visual system, *Cold Spring Harbor Symp. Quant. Biol.*, 1952, **17**, 125.
24. Hodgkin, A. L., The subthreshold potentials in a crustacean nerve fibre, *Proc. Roy Soc. London, Series B*, 1938, **126**, 87.
25. Hodgkin, A. L., The local electric changes associated with repetitive action in a non-medullated axon, *J. Physiol.*, 1948, **107**, 165.
26. Hodgkin, A. L., and Huxley, A. F., The dual effect of membrane potential on sodium conductance in the giant axon of *Loligo*, *J. Physiol.*, 1952, **116**, 497.
27. Hodgkin, A. L., and Rushton, W. A. H., The electrical constants of a crustacean nerve fibre, *Proc. Roy. Soc. London, Series B*, 1946, **133**, 444.
28. Katz, B., Action potentials from a sensory nerve ending, *J. Physiol.*, 1950, **111**, 248.
29. Katz, B., Depolarization of sensory terminals and the initiation of impulses in the muscle spindle, *J. Physiol.*, 1950, **111**, 261.
30. Kuffler, S. W., Mechanisms of activation and motor control of stretch receptors of lobster and crayfish, *J. Neurophysiol.*, 1954, **17**, 558.
31. Kuffler, S. W., and Eyzaguirre, C., Synaptic inhibition in an isolated nerve cell, *J. Gen. Physiol.*, 1955, **39**, 155.
32. Kuffler, S. W., Hunt, C. C., and Quilliam, J. P., Function of medullated small-nerve fibres in mammalian ventral roots: efferent muscle spindle innervation, *J. Neurophysiol.*, 1951, **14**, 29.
33. Lloyd, D. P. C., Electrical signs of impulse conduction in spinal motoneurons, *J. Gen. Physiol.*, 1951, **35**, 255.



34. Matthews, B. H. C., The response of a muscle spindle during active contraction of a muscle, *J. Physiol.*, 1931, **72**, 153.
35. Matthews, B. H. C., Nerve endings in mammalian muscle, *J. Physiol.*, 1933, **78**, 1.
36. Ottoson, D., and Svaetichin, G., Electrophysiological investigations of the frog retina, *Cold Spring Harbor Symp. Quant. Biol.*, 1952, **17**, 165.
37. Skoglund, C. R., The response to linearly increasing currents in mammalian motor and sensory nerves, *Acta Physiol. Scand.*, 1942, **4**, 7.
38. Svaetichin, G. The cone action potential, *Acta Physiol. Scand.*, 1953, **29**, 565.
39. Tobias, J. M., and Bryant, S. H., Lobster giant axone preparation: effect of certain enzymes on axone and on frog muscle, *Fed. Proc.*, 1954, **13**, 153.
40. Wiersma, C. A. G., Furshpan, E., and Florey, E., Physiological and pharmacological observations on muscle receptor organs of the crayfish, *Cambarus clarkii* Girard, *J. Exp. Biol.*, 1953, **30**, 136.