

DEMONSTRATION OF TWO STABLE POTENTIAL STATES IN THE
SQUID GIANT AXON UNDER TETRAETHYLAMMONIUM
CHLORIDE*

By ICHIJI TASAKI AND SUSUMU HAGIWARA‡

(From the Laboratory of Neurophysiology, National Institute of Neurological Diseases and Blindness, National Institutes of Health, Public Health Service, Department of Health, Education, and Welfare, Bethesda)

(Received for publication, February 5, 1957)

During the course of experiments designed to investigate the effects of various chemicals injected into squid giant axons (2), it was found that quaternary ammonium ions are capable of prolonging the duration of the action potential without affecting the properties of the resting membrane appreciably. A similar effect of quaternary ammonium ions upon the action potential of other excitable tissues has been reported by several investigators (8, 11, 18). Following a longitudinal injection of a proper amount of tetraethylammonium chloride (TEA) into the whole length of a giant axon, the configuration of the normal action potential undergoes a rapid change into a response with an initial peak followed by a long plateau. The response of the squid axon under TEA resembles in many respects the action potential of the cardiac muscle (28-30).

The present paper describes the results of an electrophysiological investigation of the mechanism of action potential production in the giant axon membrane under the influence of TEA. The main techniques employed are similar to those developed by Marmont (20), Cole (4), and Hodgkin *et al.* (16). Inserting long metal wire electrodes longitudinally into the axon, either the membrane potential or the membrane current was controlled and the changes in the membrane properties were examined under various experimental conditions. The results obtained are interpreted as supporting the view that there are two stable states in the membrane and that the process of initiation and abolition of the action potential (26) represents a transition of the membrane between these two stable states.

METHOD

1. *Dissection of Giant Axons.*—Giant axons were dissected out of the North Atlantic squid, *Loligo pealii*, available at the Marine Biological Laboratory in Woods

* The work presented in this article was carried out at the Marine Biological Laboratory, Woods Hole.

‡ On leave from the Department of Physiology, Tokyo Medical and Dental University, Tokyo.

Hole by the technique described by previous investigators (5, 16). The axon was carefully, though not extensively, cleaned under darkfield illumination by removing the major portion of the small nerve fibers with a pair of small scissors. The diameter of the axons used was usually between 0.55 and 0.35 mm.

2. *Longitudinal Injection of TEA.*—The axon was mounted horizontally across a glass plate 34 mm. wide and its tied ends were stretched beyond the edge of the plate. The tied ends were fixed to the lucite platform to which the glass plate was glued. With a pair of small scissors, two small incisions were made in the axon membrane, one at each edge of the glass plate. Through one of the holes made by the incision, the injection pipette of 70 to 100 μ in outside diameter was inserted along the axis of the axon. In the experiment of Fig. 3, the recording electrode was a glass pipette of approximately 60 μ inserted into the axon through the hole at the other edge of the glass plate. Injection was started when the tip of the injection pipette was near the end of the axon on the side opposite to the point of insertion. While the deeply stained solution of TEA was flowing out of the injection pipette at a uniform rate, the pipette was withdrawn at a uniform velocity. The details of the procedure of injection and precautions to be taken during this procedure will be discussed elsewhere (2). In the later experiments (Fig. 4 and others), an assembly of metal electrodes was introduced into the axon after the injection pipette had been withdrawn.

3. *Preparation of TEA Solution.*—In most of the experiments described in this paper, an isosmotic (0.55 M) solution of tetraethylammonium (TEA) chloride was prepared by diluting a commercially available drug, etamon (Parke, Davis & Company). The effect of this drug was exactly the same as that of the sample kindly supplied to us by Dr. Lorente de N6. The solution was stained with chlorphenol red and then its pH was adjusted to 6.6–6.7 by adding a trace of 0.5 M KOH solution.

The total amount of the TEA solution injected into an axon was between 0.6 and 1.2 mm³. Since the length of the injected portion of the axon was approximately 30 mm., the final concentration of TEA in the axoplasm was estimated to be between 40 and 60 mM. When a larger amount of the TEA solution was introduced into the axon, there was always an outflow of the stained TEA solution through the cut end of the axon.

4. *Recording of the Membrane Potentials.*—A glass pipette electrode of 60 to 100 μ in diameter filled with an isosmotic KCl solution was used to record both the resting and action potentials internally. A lightly chlorided silver wire of 100 μ in diameter, immersed in the fluid in the pipette, served to connect the pipette to the input of a cathode follower. A British tube, Z729, operated in triode connection, was used as a cathode follower. Its input capacity was of the order of 5×10^{-12} farad. A precaution was taken, therefore, not to use a recording electrode with a resistance exceeding a few megohms.

When recording of the resting membrane potential was not required, either a bare silver wire of 100 μ diameter or a nichrome-steel wire of 20 μ diameter was used to measure transient changes in the membrane potential. The reliability of the nichrome-steel wire electrode for this type of potential measurement has been demonstrated previously (27).

5. *Measurement of the Membrane Impedance during Activity.*—The time course of the change in the membrane impedance associated with an action potential was

determined with the arrangement schematically illustrated in Fig. 1. An alternating current Wheatstone bridge was constructed with two fixed resistors, r_1 and r_2 , a variable resistance ($0 \sim 0.2 \text{ M}\Omega$) with a parallel capacity (up to $200 \mu\text{mfd.}$), and with electrodes in and outside the axon membrane. The internal impedance electrode was made with an enamelled silver wire, the enamel of which was removed for a length of 10 mm. at the tip. The bare portion of the wire was inserted in the middle of an axon of 34 mm. length. The resistors in the ratio arms of the bridge, r_1 and r_2 , were 10

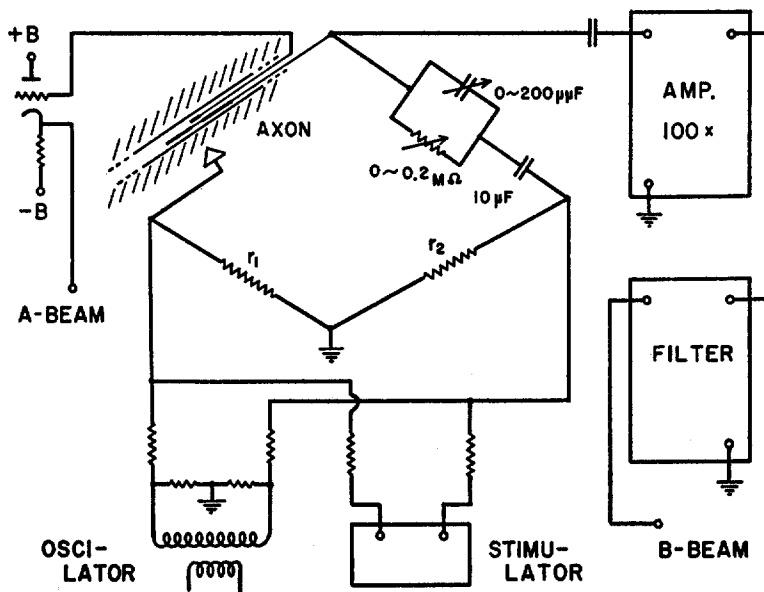

FIG. 1. Diagram illustrating the impedance bridge used to record the time course of the impedance loss during activity. The long impedance electrode was a metal wire with 10 mm. long exposed surface. The potential electrode had 1 mm. long exposed surface. Resistances r_1 and r_2 were 10 and 100 (or 200) ohms respectively. Further explanation in text.

and 100 ohms (or 10 and 200) respectively. The bridge A. c. was usually 20 kc./sec., in some cases 10 kc./sec., and was supplied by a beat-frequency oscillator (General Radio, type 1304-A). The A. c. voltage across r_1 was not allowed to exceed about 30 mv. peak-to-peak.

The bridge unbalance was amplified 100 times with a preamplifier (Tektronix, type 122) and then filtered by a variable electronic filter (Spencer-Kennedy Laboratory, Model 302) which was adjusted to pass a narrow band of frequencies around the bridge A. c. frequency. The output of the filter was led to one channel of a dual beam oscilloscope (DuMont, type 322). The ringing in the filter circuit following a short transient pulse decayed at a rate of approximately one-third per cycle at 20 kc./sec.

To record action potentials of the axon simultaneously with the membrane im-

pedance, an independent metal wire electrode ($20\ \mu$ steel wire) was inserted into the axon together with the impedance electrode. Direct metallic contact between the two internal electrodes was prevented by using enamel and De Khotinsky cement. The membrane potential was recorded at the middle of the bare portion of the impedance electrode. In later experiments, action potentials were recorded through the impedance electrode. Stimulating current pulses from a stimulus isolation unit (Grass Co., Model SIU-4A) were delivered to the axon through the impedance electrode.

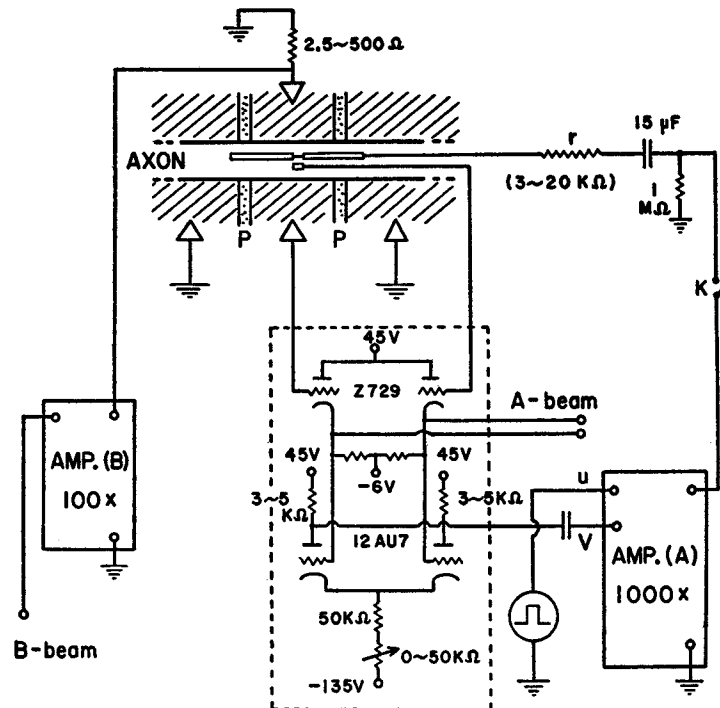

FIG. 2. Diagram showing the arrangement used for voltage clamp experiments. The thick portions of the electrodes indicate the exposed surfaces of the metal wire electrodes. The portion of the axon between the two partitions was approximately 9 mm. long. Further explanation in text.

Under these circumstances, the axon membrane is partly short-circuited by the variable resistance. Because of the blocking condenser ($10\ \mu\text{fd.}$) connected in series with the variable resistor and condenser, the distortion of the recorded action potential by the bridge was not very serious. A slightly disturbing artefact arising from this circuit was the complication caused by the stimulating current charging the variable condenser in the diagram. When the voltage pulse from the stimulus isolation unit comes to an end, the axon membrane is subjected to a short current flowing in the reversed direction. Because of this artefact, it was somewhat difficult to abolish the action potential with the arrangement of Fig. 1.

With this impedance bridge, a considerable difficulty was encountered when an attempt was made to determine the absolute values of the membrane capacity and resistance. At 20 kc./sec. the A. C. voltages at the two outputs of the oscillator were not exactly in opposite phase. There were stray capacities which prevented the bridge from operating under simple, ideal working conditions. Unless the frequency of the bridge A. C. was lowered below about 5 kc./sec., it was not possible to correctly determine the capacity and the resistance in the unknown arm from the readings in the known arms. In the present paper, therefore, the method of impedance measurements was used to obtain more or less qualitative information as to the conductance of the membrane during activity, the bridge unbalance being considered as a monotonic function of the membrane conductance. A simple calculation of the membrane impedance shows that the bridge unbalance should be proportional to the change in the membrane conductance except at or near the peak of activity.

6. *Voltage Clamp*.—The arrangement diagrammatically shown by Fig. 2 was employed to measure the membrane current necessary to “clamp” the membrane potential along a rectangular time course. A giant axon was mounted horizontally on a glass plate as in the other experiments. The glass plate used in this experiment was, however, provided with a pair of partitions (*P* in the figure) made with pieces of lucite plates and with a small amount of vaseline. An assembly of metal wire electrodes similar to that used in the impedance measurement was introduced into the axon as shown in the diagram.

A rectangular voltage pulse from a pulse generator (Tektronix, type 161) was led into one of the two inputs of a differential amplifier (Tektronix type 122) which had a flat response between 40 kc. and 0.1 c.p.s. The output of the amplifier (Amp. A in the figure) was connected to the long metal wire electrode in the axon through a key (*K*), a condenser (15 μ fd.), and a resistor (3 to 20 kilohms). The polarity relationship between the input and the output of the amplifier was such that when the potential at the input was rapidly raised (*i.e.* $u > 0$), there was a sudden flow of current from the electrode in the axon into the axoplasm. Such a sudden flow of an outward current should result in a sudden rise in the membrane potential which eventually transmitted to the second input of the differential amplifier (Amp. A). The cathode follower stage, indicated by a square box of a dotted line, was designed simply to transmit the potential difference across the axon membrane to the single-ended output of the stage. The principle of voltage clamping by this arrangement is as follows:—

In the steady state during which the potential (u) at the input of the differential amplifier (A) is maintained at a certain positive level, there is a continuous flow of an outward current through the axon membrane which maintains the membrane potential (V) approximately at the potential of the input of the amplifier (A). Denoting the voltage from the pulse generator by u , the gain of the differential amplifier (A) by n , the resistance between the output of the amplifier and the internal electrode by r , and the variation in the membrane potential by V , one finds that in the steady state the membrane current I is given by the expression

$$I = \frac{n(u - V) - V}{r}$$

(The gain of the cathode follower stage is assumed to be unity.) If the value of $(V + Ir)/n$ is negligibly small compared with V or u , therefore, V should be equal

to u . The current I varies with the membrane resistance R and with any change in the e. m. f. of the membrane. If one assumes for simplicity that the e. m. f. of the membrane stays constant during the period of voltage clamp, then $V = IR$. Introducing this relation into the above expression for I , one obtains the relation

$$I \left(R + \frac{R}{n} + \frac{r}{n} \right) = u.$$

Since n is 10^3 and r is about 5×10^8 ohms in the present experimental conditions, the term r/n in the parenthesis is equal to 5 ohms. As long as R (the resistance of the axon membrane between the two partitions) is far greater than 5 ohms, IR should be approximately equal to u no matter how R varies during the voltage clamp. For a portion of the axon of 8 to 9 mm. length, the resistance R of the membrane under TEA undergoes a transient reduction from the resting value of 15 to 20 kilohms down to 300 to 500 ohms when V is about 80 mv. (see section 4 under Results). The membrane potential V should, therefore, diverge from u by 1 to 2 per cent. Actually there is a rise in the e. m. f. of the membrane when R goes down; this situation tends to reduce the divergence considerably.

In a normal axon, *i.e.* in an axon without injection of TEA, the membrane resistance undergoes a greater reduction during activity. Consequently a small variation in the membrane potential was observed when an attempt was made to clamp the membrane at a potential slightly higher than the ordinary threshold level. A correction was made for this small potential variation by superposing a small double condenser pulse on the square pulse of u . By adjusting the size and the delay of this double condenser pulse, it was always possible to vary the membrane potential along a rectangular time course.

The membrane current required for clamping the potential was determined by recording the potential drop across a small resistor (2.5 to 500 ohms) connected between the sea water around the axon and ground. By choosing a proper value for this resistor, the potential drop across this resistor was restricted to a range not exceeding a few millivolts. The currents flowing through the internal current electrode near its ends did not enter into the record because of the two lateral electrodes grounding the lateral pools of sea water independently.

A precaution has to be taken with this circuit to prevent an oscillation in the amplifier. In practice a high-frequency oscillation was found to start only (*a*) when the resistance between the axon and the external electrodes was unduly raised by reducing the amount of sea water around the axon, or (*b*) when the electrical contact between the potential electrode and the axoplasm became poor. Another precaution to be taken is to adjust the d. c. output voltage of the differential amplifier (A) carefully to zero; otherwise there will be a transient change in the membrane potential when the contact K is closed. With this arrangement it is not possible to clamp the resting potential of the membrane at new artificial levels.

RESULTS

1. *Prolongation of the Action Potential by TEA.*—An internal recording electrode, a glass pipette in this series of experiments, was thrust down the

axis of a giant axon until the recording tip reached the point half-way between the two ends of the axon. Then, the injection pipette was introduced into the axon through a hole at the other end of the axon. The tip of the injection pipette was pushed beyond the recording electrode so that a considerable portion of the two pipettes overlapped in the axon. This procedure was not difficult when the diameter of the axon was around $500\ \mu$. Since both of the pipettes were slightly smaller than $100\ \mu$, it was possible to maneuver these pipettes in the middle of the axon without touching the membrane. Stimulating shocks were applied to the axon near one of the ends of the axon, usually on the side where the injection pipette was introduced.

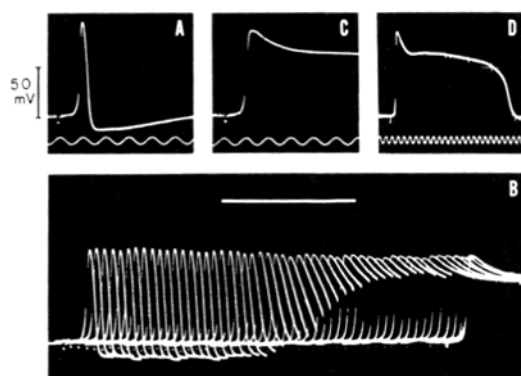

FIG. 3. Records showing changes in the time course of the action potential caused by intracellular injection of tetraethylammonium chloride. Record A, before injection. The white line in record B represents the time during which the injecting pipette was moved from one end of the axon to the other; shock interval, 1 sec. Records C and D, after injection. Time marker, 1 msec. 22°C .

Record A in Fig. 3 was obtained when the two pipettes were in the axon (but before the injection of TEA). The size and shape of this action potential are similar to those obtained by previous investigators (6, 12). Record B was taken with a continuously moving film, while the axon was being stimulated at a frequency of 1 shock per sec. The bar in this record indicates the period during which the TEA solution was injected into the axon. During this period the injection pipette was moved toward the point of insertion at a uniform velocity.

Within a few seconds after injection of the TEA solution into the space around the recording electrode, the duration of the response was found to start to prolong. As can be seen in the figure, TEA did not change the resting potential of the axon. A marked prolongation of the spike duration was often associated with a slight (5 to 10 per cent) reduction in the spike height. Records C and D are single-frame photographs taken after injection.

After rapid prolongation of the spike duration following an injection of TEA, the spike showed a slight tendency to a further prolongation. Then, a steady state was reached and the spike remained unchanged for more than several hours. The spike duration in the steady state depended upon the amount of TEA injected into the axon; a small amount of TEA brought about a small change in the response, and too large an amount reduced the spike height without producing a profound prolongation. In the following experiments, an injection of 0.6 to 1.2 mm.³ of isosmotic TEA solution into a 30 mm. length portion of an axon of 500 μ diameter was chosen as a standard procedure. This procedure altered the normal spike of about 0.7 msec. duration at room temperature (22°C.) into a response of 10 to 30 msec. duration.

Besides a marked increase of the total spike duration, TEA brought about a conspicuous change in the configuration of the response. Following a quick



FIG. 4. Effect of long test pulses of constant current upon the time course of the membrane potential. The pulses were applied through a long internal electrode and the membrane potential was recorded in the middle of the long internal electrode. In each record two sweeps are superposed.

fall in the membrane potential from the peak, the potential began to fall at an extremely small rate, forming a "plateau." This plateau was abruptly terminated by a "shoulder," the potential level of which varied considerably with the amount of TEA injected. There was, as a rule, an "undershoot" of potential following the end of the spike potential. Evidently, there is a striking similarity between the action potential of the squid giant axon under TEA and that of the cardiac muscle (7, 17, 28-30). When the squid axon under TEA was cooled down to 3°C., the spike duration was found to increase up to 500 msec. or more. Under such circumstances, a record of a squid action potential would be almost indistinguishable from that of a cardiac muscle (*e.g.* Fig. 8E in reference 29). It will be shown in the following sections that this similarity between the squid axon under TEA and the cardiac muscle is by no means superficial.

When the TEA solution was introduced in one-half of the whole length of the axon, it was possible to show, by moving the recording electrode along the axis of the axon, that the response has a normal duration in the normal region

and a tremendous duration in the injected region. Near the boundary between the normal and injected regions, a mixture of long and short responses was obtained. Such preparations often showed repetitive firing of responses, resulting probably from an interaction between prolonged and normal responses.

We have not examined the effect of TEA injected at one spot of an axon as in the experiments by Grundfest, Kao, and Altamirano (10). However, it appears to us certain that such a localized injection of TEA would not effectively prolong the spike duration, because, as we shall see in the following sections, the normal responses from the neighboring region would "abolish" the response from the injected region.

It is interesting to note that various mixtures of the TEA solution and sea water up to one to one ratio applied externally to the squid giant axon (for 1

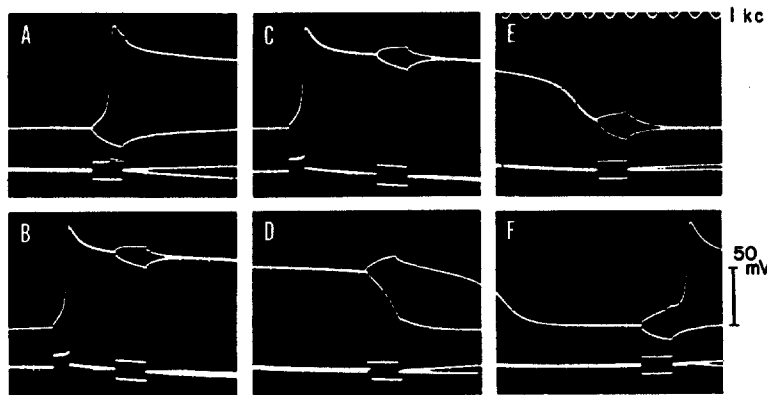

FIG. 5. Same as Fig. 4, except that the current pulses were shorter and stronger. The lower trace indicates the time course of the membrane current.

hour or more) did not bring about any appreciable change in the duration of the recorded action potential.

2. *Resistance of the Axon Membrane during Activity.*—The similarity between the response of the squid axon under TEA and that of the cardiac muscle became more impressive when the membrane resistance during activity was compared in the two systems. The resistance measurements on the squid axon membrane were made with two internal metal wire electrodes inserted into the axon as shown in Fig. 1. When the test pulse method was employed to estimate the membrane resistance, the long current electrode was connected to a pair of square pulse generators through two separate 1 megohm resistors. Recordings were made through the other metal wire electrode which had its exposed surface of 1 to 2 mm. long in the middle of the current electrode. A limitation of this method of measuring the membrane resistance was that the

intensity of test pulses has to be kept at a low level in order to avoid initiation or "abolition" of responses.

Fig. 4 shows an example of the records obtained by using subthreshold test pulses. The current pulses delivered during the plateau of the action potential (record C in the figure) brought about a potential variation which was nearly as large as (or slightly greater than) that observed a long period of time after the end of the action potential (record A). At the peak of the action potential, the potential variation caused by a current pulse of the same intensity was definitely smaller, indicating that the membrane resistance was very low at that moment.

This property of the membrane during activity is very similar to that of the vertebrate cardiac muscle (Fig. 16 in reference 29), and also to that of the crustacean muscle fiber treated with tetrabutylammonium ions (Fig. 13 in reference 8). In both of these muscle fibers, there was an apparent increase in the membrane resistance toward the end of the action potential. This has also been shown to occur in the squid axon under TEA.

Record D in Fig. 5 shows the effect of current pulses applied near the end of the action potential prolonged by TEA. The potential variation caused by the pulse of an outward current (shown by the upward deflection in the figure) has a size similar to that of the potential changes produced by inward current pulses in records A, C, E, and F. It is seen that the pulse of an inward current in record D brought about a disproportionately large potential variation. As has been pointed out by Fatt and Katz (8), this anomalous behavior of the membrane at the end of an action potential is an indication of a premature termination or abolition of the response and does not necessarily indicate a high membrane resistance at this moment. Similarly, the large effect caused by outward current pulses in records E and F is undoubtedly attributable to the tendency of the axon membrane to respond to the test pulse with a second action potential. The slightly smaller potential variation seen in record B is an indication of a smaller membrane resistance at this moment.

The results obtained by the impedance method (Fig. 1) are consistent with those described above. In Fig. 6, the records in the left column were taken from a normal; *i.e.*, non-injected, axon. The upper record was taken with the bridge balance for the impedance of the axon at rest. The lower record was obtained by adjusting the bridge in such a way that the best balance was observed at the peak of the action potential. The temporal relationship between the impedance loss and the membrane potential in these records is similar to that reported by Cole and Curtis (5).

The records in the middle column were taken from an axon into which the TEA solution had been injected. In spite of the tremendous difference in the falling phase of the action potential between the normal and the TEA-treated axons, the time course of the impedance loss during activity was not very

different in the two axons. The maximum impedance loss was less in the TEA-treated axon than in the normal. The quantitative aspect of this difference, however, was worked out by the method of voltage clamp (section 4) and not by the method of impedance measurement.

The records in the right-hand column in Fig. 6 were taken with a slower time base at a lower bridge frequency. Although the time resolution was re-

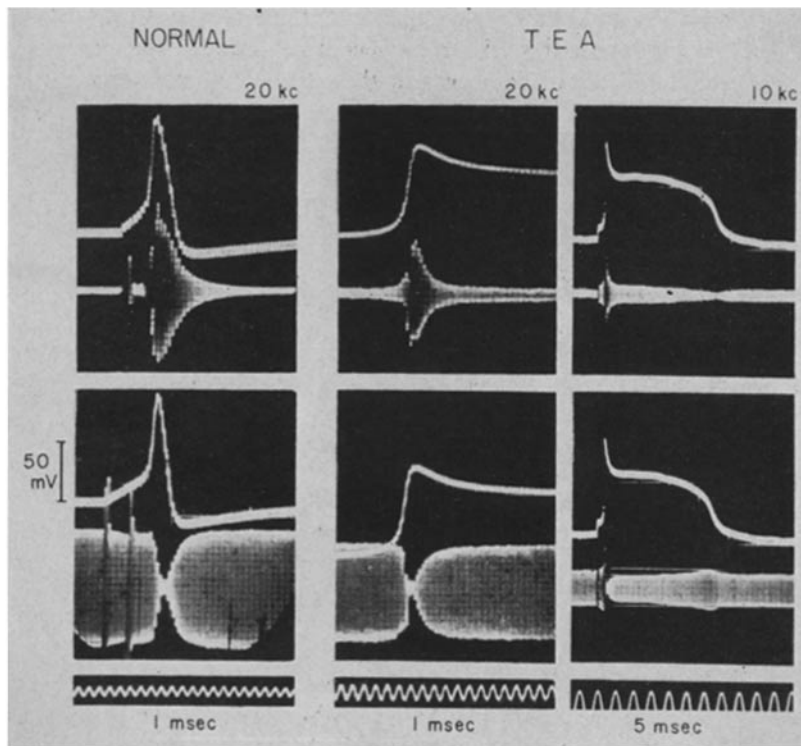

FIG. 6. Simultaneous recording of the action potential and the membrane impedance in a normal axon (left) and in the same axon treated with tetraethylammonium chloride (right).

duced by lowering the bridge frequency, the sensitivity of the bridge to slow impedance changes was greatly enhanced. In these records the unbalance at the peak of the action potential was so large in amplitude that it was not discernible. It is seen in these records that during the falling phase of the action potential there was a gradual return of the membrane impedance toward the normal. At about the shoulder of the action potential, the membrane impedance rose slightly above the resting value.

3. *Abolition of Action Potentials.*—The electrode arrangement used to demonstrate abolition of action potentials in the squid axon was the same as that for the experiments of Figs. 3 and 4. Through the long current electrode, a strong, short pulse of inward or outward current was applied to the membrane to produce a sudden change in the membrane potential during the course of an action potential. The duration of the pulse was about 0.2 msec. or less; its intensity was adjusted to produce a potential variation of 10 to 100 mv. A typical example of the results is presented in Fig. 7.

When a weak pulse of inward current was passed through the membrane in the falling phase of an action potential, the membrane potential went down

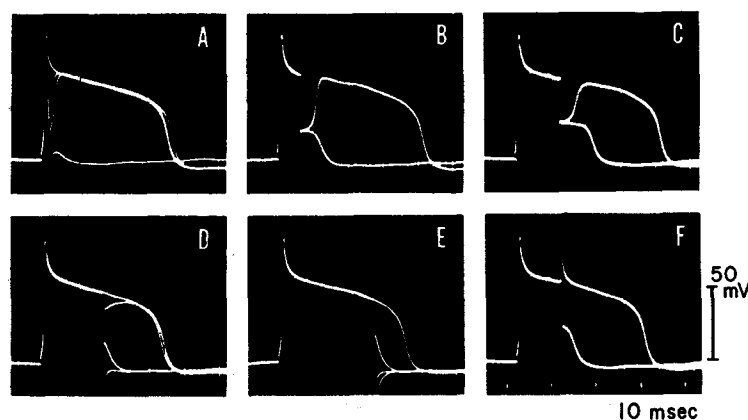

FIG. 7. Effect of short, strong current pulses applied during the course of action potential of a giant axon treated with tetraethylammonium chloride. Two to four sweeps were superposed on each record.

during the short period of current flow. Then, on termination of the pulse, the potential returned rapidly to the level which would have been attained if the pulse had not been delivered (records A and D). The amount of the potential change increased with the intensity of the current pulse. When the pulse intensity exceeded a certain value, the membrane potential did not rise after the end of the applied pulse, but instead it went down to a definite level which was independent of the applied shock. The premature termination, or abolition, of the action potential in the squid axon was found to be all-or-none, just as in the nodal membrane of the myelinated nerve fiber and in the cardiac muscle (26, 29).

When the pulse intensity was adjusted to the threshold for abolition, records as shown in Fig. 7 B and C were obtained. The membrane potential stayed at an approximately constant level for a variable length of time and then it went either up or down to reach one of the "two stable potential levels." This

variability in the time course of the membrane potential is analogous to that seen in initiating an action potential by a threshold stimulus. In record F the effect of a pulse of an outwardly directed current is shown together with that of an inward current of the same intensity.

It is interesting to note that the "threshold membrane potential" for abolition rises continuously during the course of activity. In the early phase of the action potential, the threshold potential was close to the ordinary threshold potential necessary for initiating an action potential (record A). As the membrane potential gradually fell, the threshold membrane potential for abolition rose continuously and approached the level of the "shoulder." With the abolishing pulse delivered near the shoulder as in record E, it was difficult to determine the threshold for abolition, because of the great liability to abolition

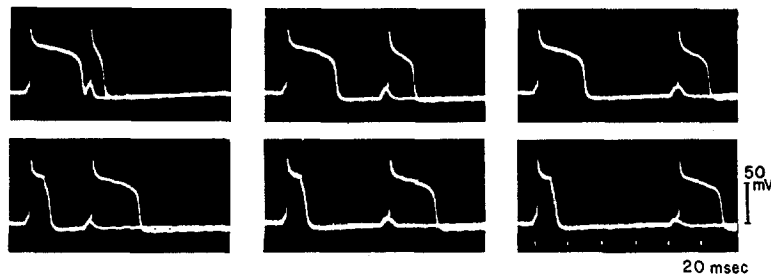

FIG. 8. Upper row, demonstration of refractoriness following a prolonged response of a squid giant axon treated with tetraethylammonium. The second, test shocks were adjusted to the threshold and two successive sweeps were superposed. Lower record, demonstration of absence of refractoriness after an abolished action potential of the same axon.

at this stage. These observations support the view that the natural termination of an action potential is the result of the impingement of the membrane potential upon the abolition threshold (26).

Another point of interest in Fig. 7 is the fact that there is an "undershoot" of variable sizes following abolition of an action potential. Following an unabolished action potential, the membrane potential stays at a level of 5 to 10 mv. below the level of the resting potential. When the action potential was abolished in its later phases (records D and E), it was found that the lower potential level which was attained by the membrane following abolition was close to that of the normal undershoot. As the abolishing pulse was delivered in the earlier phases, the lower stable potential level gradually approached the initial resting potential (records A and B). This finding indicates that the lower stable potential level (to which the membrane approaches following abolition) undergoes a progressive lowering during activity. At the

end of an unabolished action potential, when the membrane undergoes a natural transition from the upper stable state to the lower, this lower stable state is at the level of a full sized undershoot.

It has been shown in the nodal membrane that there is no absolute refractoriness following an abolished action potential (26). In Fig. 8 an example of the results of a corresponding observation in the squid axon is presented. The records in the upper row show the refractoriness following an unabolished action potential of a TEA-treated axon. As the interval between the two re-

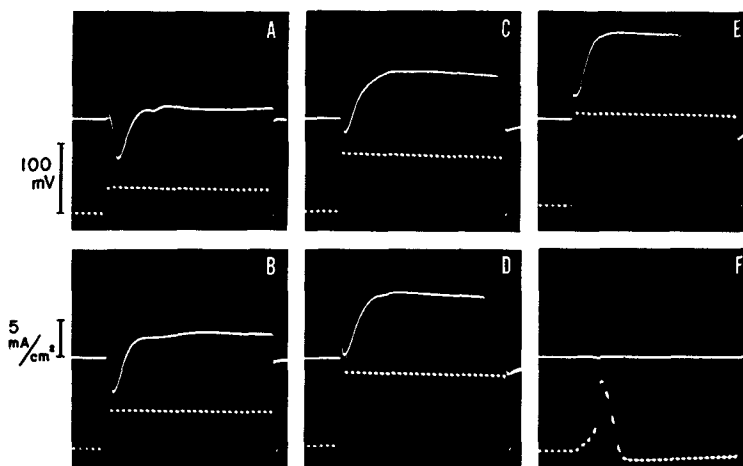

FIG. 9. Records of membrane current associated with rectangular depolarization of a normal giant axon taken with the arrangement of Fig. 2. The dotted lines in records A to E show the time courses of the membrane potential maintained by the method of voltage clamp. Record F was taken by passing a short pulse of outward current through the membrane and later keeping the membrane current at practically zero. Blanking, 0.1 msec. interval. The area of the axon membrane under investigation was approximately 0.11 cm². Temperature 22°C.

sponses decreased, the duration of the second response was greatly reduced. The spike amplitude was also reduced during the refractory period. When the first response was abolished in its early phase, all the signs of the refractoriness following the first response were almost completely wiped out.

4. *Voltage-Current Relation.*—Using the experimental arrangement shown diagrammatically in Fig. 2, it was possible to shift the membrane potential from its resting level quickly to a new constant level and to maintain this new level by an automatic adjustment of the membrane current. In order to compare the behavior of a TEA-treated axon with that of a normal axon, “voltage-clamp” experiments were done on normal as well as on TEA-treated axons. The records in Figs. 9 and 10 show the time courses of the membrane potential

(dotted lines) together with the membrane currents required to maintain these potential levels.

In these records, as well as in the previous ones, an *upward* deflection of the potential trace indicates *positivity* of the axoplasm potential. For the current traces an *upward* deflection corresponds to an *outward* current through the axon membrane. According to this convention, the behavior of a simple ohmic resistor is represented by the parallelism between the deflections of the two traces.

Our results obtained from normal axons, one example of which is presented in Fig. 9, are very similar to those reported by Hodgkin *et al.* (16). The large capacitative current that flows at the onset of a sudden depolarization is barely discernible only as a short break in the current trace. Hodgkin, Huxley, and Katz (p. 426 in reference 16) assume, without presenting supporting evidence, that the capacity of the membrane is connected in parallel with the batteries with series resistances (see Fig. 13A in Discussion) and consequently that the membrane current observed during the voltage clamp is purely ionic. Since we do not consider these authors' argument justifying their separation of this "ionic" current further into sodium and potassium currents as convincing (see Discussion), we describe our experimental results simply in terms of membrane currents and membrane potentials without referring to the physical nature of the potentials and currents.

When the current intensities at the peak of the inward (downward in the figure) surge of the membrane current are plotted against the changes in the membrane potential, it is found that there is a linear relationship between the voltage and the current in a wide range of membrane depolarization (from 50 up to 120 mv. or higher). This is consistent with the results obtained by Hodgkin and Huxley (p. 477 in reference 14). The membrane resistance determined from the slope of this linear relationship was, at 22°C., 7 to 10 ohms·cm.² (3 axons) and, at 11°C., 12 to 14 ohms·cm.² (2 axons). This value of the membrane resistance is considerably smaller than those reported by Hodgkin and Huxley (p. 465 in reference 13) who gave a figure of about 30 ohms for 1 cm.² of membrane.

The membrane potential at which the membrane current at the peak of the inward surge vanishes represents the effective E.M.F. of the membrane at this moment. This value coincides with the membrane potential at the peak of an action potential (compare records D and F in Fig. 9). The final, steady level of the membrane current during voltage clamp varies also linearly as the membrane potential (for membrane depolarization greater than about 40 mv.). This linearity gave a resistance of 9 to 12 ohms·cm.². and an apparent membrane E.M.F. of 20 to 30 mv. above the resting potential (22°C.). The resistance of the resting membrane measured by clamping the potential at small negative levels was between 2 and 3.5 kilohms·cm.²; the value given by Hodg-

kin *et al.* for the corresponding measurement is $2.3 \text{ kilohm}\cdot\text{cm}^2$ (p. 440 in reference 16).

The voltage-current relation of the membrane was strongly modified by injection of TEA. Fig. 10 (and also Fig. 12, left), shows the results obtained from axons of which the action potential had been prolonged by TEA. In these records certain features deserve emphasis. The membrane potential at which the peak of the initial surge of current vanishes coincides with the peak of the action potential elicited by a brief stimulating current; undoubtedly this property is common for both the normal and TEA-treated axons. The voltage-

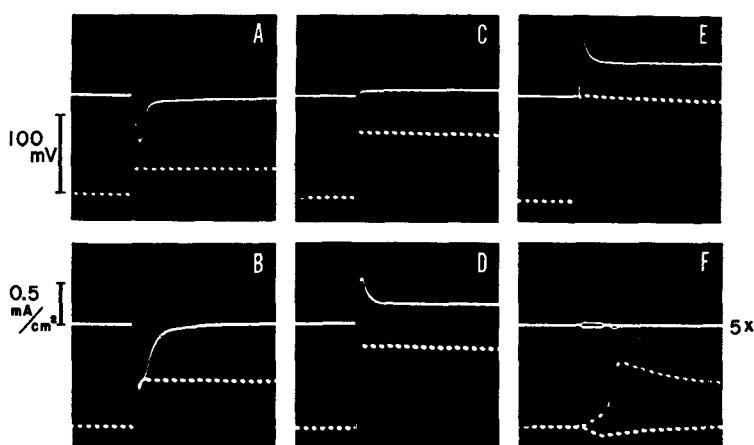

FIG. 10. Records of membrane current associated with rectangular depolarization of the membrane of a squid giant axon treated with tetraethylammonium. The dotted lines show the time courses of the potential difference between the internal and external recording electrodes. Record F shows the action potential of this axon together with the membrane current recorded at a higher recording sensitivity. Blanking, 0.5 msec. apart. The area of the axon membrane under investigation was approximately 0.12 cm^2 . Temperature 22°C .

current relationship at the peak of the initial surge was linear for depolarizations greater than about 50 mv. The membrane resistance determined by this linearity was 25 to 50 $\text{ohms}\cdot\text{cm}^2$ (6 axons at 22°C .); this finding is consistent with the fact that the maximum impedance loss during activity was smaller in the TEA-treated axons than in the normal.

Another conspicuous feature in the records of Fig. 10 is that the membrane current during the maintained membrane potential is extremely small compared with the case of Fig. 9 for a normal axon. This would not be surprising in view of the fact that the membrane resistance is almost normal during the plateau of an action potential (Fig. 4). When the axon membrane treated with

TEA is clamped at the level of the peak of the action potential as in record C in Fig. 10, the state of the membrane should be very similar to that of a membrane (without a voltage clamp) developing an action potential (record F); the difference would be that, under the conditions of voltage clamp, the membrane potential is maintained at the peak level with the aid of a continuous outward current. The small membrane current during the later phase of voltage clamp is therefore a direct consequence of the relatively high resistance during the plateau of the action potential. (The term "action potential" is used to represent the response of the membrane observed when the membrane current is nearly zero.)

No significant difference was observed between the resting membrane resistance of a TEA-treated axon and that of a normal axon.

5. Stable and Unstable States of the Membrane as Revealed by Voltage Clamp.—When the membrane potential of an axon treated with TEA is clamped at a level of 50 to 75 mv. above the resting potential, the membrane is traversed first by a strong inward current followed by a rapid decrease in the membrane current (Figs. 10B and 11). This amount of sudden depolarization is sufficient to induce a full sized "response" of the membrane as indicated by the appearance of a full sized E.M.F. in the membrane and a full sized reduction in the membrane resistance. Following the peak of this response, the effective membrane-E.M.F. gradually falls and the membrane resistance rapidly increases, resulting in a rapid decrease in the membrane current.

In the experiment of Fig. 11, the membrane potential was suddenly shifted to a second new level at the moment when the membrane current had reached zero at the end of the first step of the maintained membrane potential. This procedure is similar to that used previously by Hodgkin and Huxley (14). When the second voltage step was relatively small, as is the case in the left-hand diagram, the membrane current showed a sudden jump which was roughly proportional to the size of the second step. The membrane resistance estimated from the voltage-current relation at this moment gave a figure comparable to that of a resting membrane. The procedure of this experiment is evidently analogous to that for measuring the membrane resistance during activity (Fig. 4).

When the second voltage step was large enough to bring the membrane potential to a level slightly below the resting potential (right-hand diagram in Fig. 11), it was found that the membrane again showed a positive (slope) resistance of the same order of magnitude in this range of membrane potential. We call the membrane potential at which the current through the membrane with a positive (slope) resistance vanishes simply the effective membrane-E.M.F.. (In the theory of Hodgkin and Huxley (15), this is considered as a weighted average of the Na and K potentials.) It can be seen in the diagram that there is a stable level of the membrane-E.M.F. at about 10 mv. below the

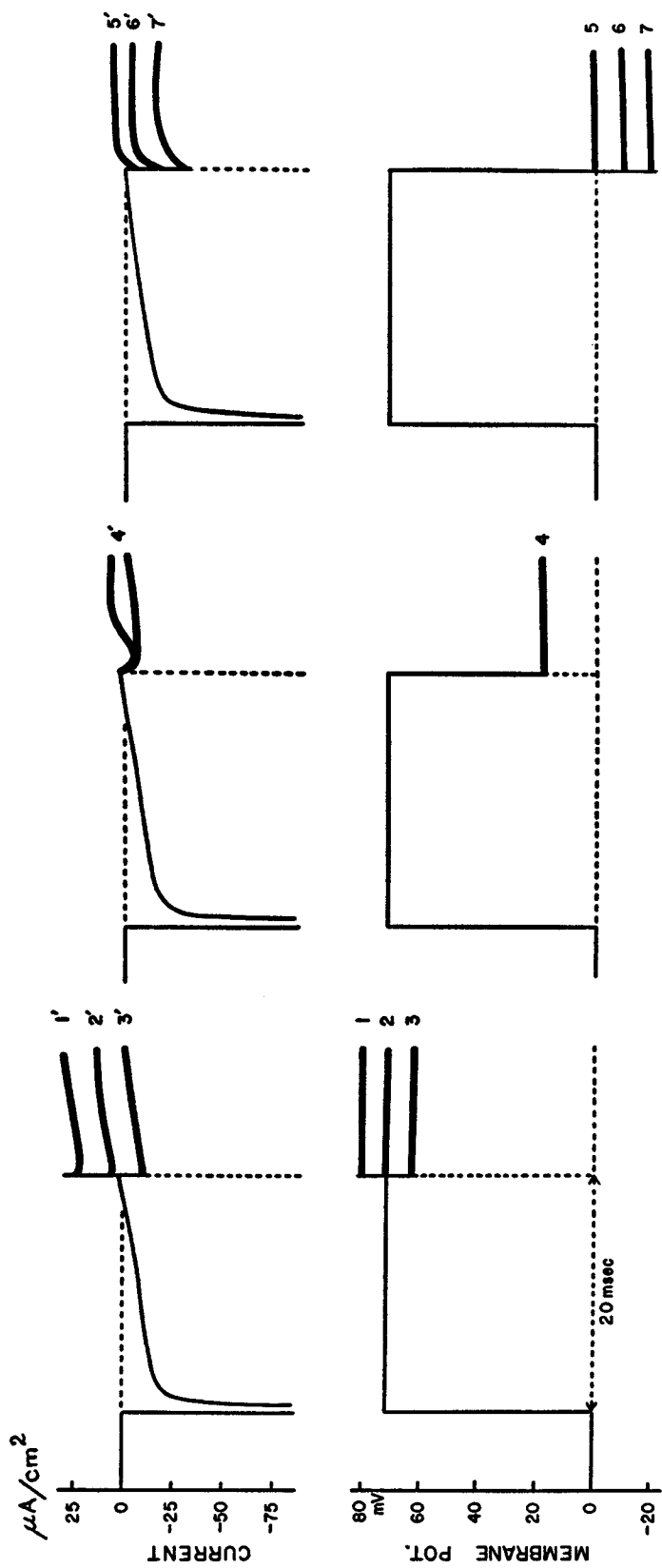

Fig. 11. Diagram showing the time courses of the membrane currents (top) associated with changes in the membrane potential shown at the bottom of the figure. In the two lateral diagrams, traces from three different photographic records were superposed; the corresponding numerals indicate the pairs of traces taken from the same records. In the middle diagram, two records taken at the same membrane potential were superposed. The area of the axon membrane was approximately 0.17 cm^2 . Temperature 22°C .

resting potential; this coincides roughly with the level of the undershoot in the experiment of Fig. 7D. This fact is not surprising since both in Fig. 11, right, and Fig. 7D, the actual experimental procedure is to shift the membrane potential from one level at which the current is zero to another level at which the current is also almost zero.

A state of the membrane described by a positive (slope) resistance and a definite effective membrane-E.M.F. is stable. When the membrane current is reduced to zero, the potential of such a membrane approaches the level of

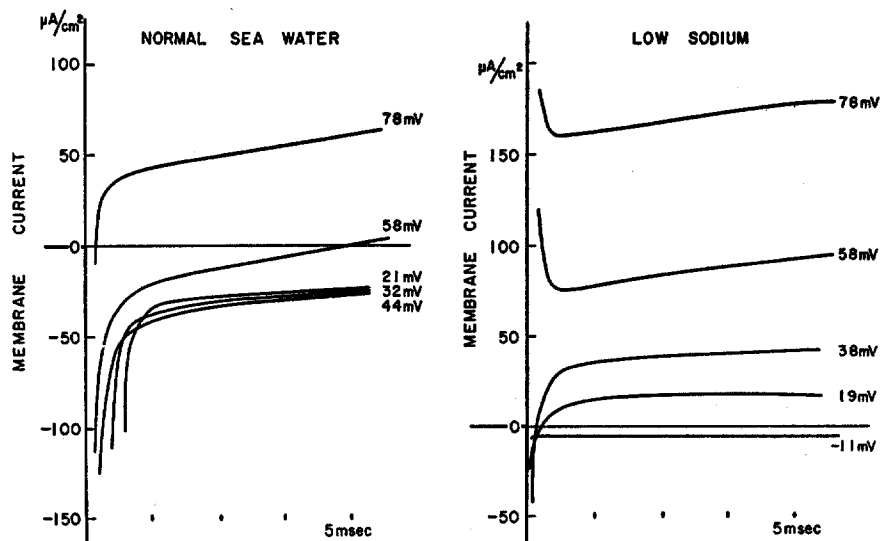

FIG. 12. Effect of replacing normal sea water around the axon with sodium-free sea water upon the voltage-current relation of an axon treated with tetraethylammonium. The sizes of membrane depolarization are given. (It is possible that there were some sodium ions remaining in the medium when the records reproduced in the right-hand diagram were taken.) The area of the axon membrane under investigation was approximately 0.19 cm^2 . Temperature, about 22°C .

the E.M.F. at the rate determined by the product of the membrane resistance and the membrane capacity.

It has been shown (Fig. 7) that, between the upper and lower stable states, there is an "unstable" state at which the membrane current may vanish for a short period of time but the membrane potential is extremely labile. The diagram in the middle of Fig. 11 shows the voltage clamp counterpart of the demonstration of this unstable state. When the second voltage step was at the level (4) in the diagram, the membrane current sometimes stayed at a negative (inward) level for more than 10 msec. and sometimes it shifted rapidly

to a positive level. At this level the behavior of the membrane current was entirely unpredictable under the voltage clamp conditions.

6. *Effect of Low Sodium in the Medium.*—The first conspicuous effect of replacing the sodium ions in the sea water with choline is a rapid decrease in spike amplitude and duration. This is another demonstration of the similarity between the action potentials of the cardiac muscle and of the squid axon under TEA; Draper and Weidmann (7) and Brady and Woodbury (3) have shown a similar effect of a low sodium medium upon the vertebrate heart. We have not investigated the quantitative relationship between the external sodium concentration and the spike amplitude.

In Fig. 12 a comparison is made of the voltage-current relations in a TEA-treated axon in normal sea water with those of the same axon in a low sodium sea water. After a series of records had been taken in normal sea water, the fluid around the axon was replaced with an artificial sea water in which the sodium ions were replaced with choline. The action potential induced by short current pulses became gradually smaller. When an apparent steady state had been reached, the voltage-current relationship was examined by the voltage clamp technique. After a period of 10 to 20 minutes in low sodium sea water, the fluid around the axon was replaced with normal sea water. The recovery of the spike amplitude and the duration was as a rule perfect.

The voltage-current relation observed in normal sea water (left diagram) is consistent with those in Fig. 10. When the sodium concentration in the medium was reduced (right diagram), the membrane potential at which the peak of the membrane current reversed shifted from the value of about 88 mv. in this case to about 45 mv. Except during the short initial phase, the membrane current flowed in the direction imposed by the applied voltage. It is seen in the diagram that increasingly stronger currents are needed to maintain the membrane potential at higher levels. There was a considerable amount of rectifying action in the membrane treated with TEA; but we received the impression that the rectifying action in such axons was less than that in axons without TEA.

DISCUSSION

Although we know at present nothing about mechanism of prolongation of the spike duration by TEA, the configuration of a prolonged action potential of the squid giant axon is very familiar to many physiologists. The similarity between this prolonged action potential and the normal response of the vertebrate cardiac muscle has been mentioned under Results. The similarity between the response of the crustacean muscle fiber under tetrabutylammonium (8) and the squid response under TEA has also been pointed out in connection with the time course of the membrane resistance during activity. The response of the frog (or toad) motor nerve fiber under such drugs as emetine, brucine, sinomenine, hypertonic NaCl solution (25), strychnine (21), or azide bears

also some resemblance to the prolonged squid response. The toad nerve fiber after prolonged tetanic stimulation develops action potentials strikingly similar to the prolonged squid responses (24). The action potential of a *Nitella* cell treated with guanidine (22) seems also to bear some resemblance to the action potentials described above.

We made an attempt to explain the mechanism of production of prolonged action potentials in the squid in terms of the sodium theory of Hodgkin and Huxley (15). The fact that the response of a squid axon under TEA is strongly reduced in size and duration by the reduction of sodium ion concentration in the medium is an indication of a high sodium requirement in this excitable membrane. In other words, the squid axon under TEA is, unlike the crustacean

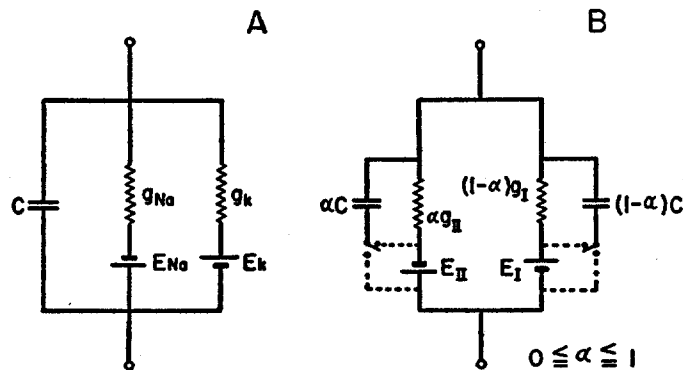

FIG. 13. A, circuit diagram proposed by Hodgkin and Huxley to represent the membrane of the squid giant axon. B, circuit diagram proposed to explain the anomalous behavior of the membrane (Figs. 5D, 6 right, 12 left, etc.) in terms of the "mixed state" of the membrane; the condition $\alpha = 0$ represents one of the two stable states, and $\alpha = 1$ represents the other stable state. Further detail in text.

muscle or *Nitella* cell mentioned above or some of the frog nerve fibers (18), not an exception to the classical form of the sodium hypothesis (Overton, 23). When an attempt was made to interpret the time course of the prolonged action potential in the squid axon in terms of the mathematically formulated, modern sodium theory (*cf.* Fig. 13A), however, a number of difficulties were encountered. We shall discuss some of these difficulties below.

1. If the prolonged action potential is produced by an increase in g_{Na} in the diagram of Fig. 13A, the membrane conductance has to be far higher than its value at rest all during the plateau of the action potential. Actually this is hardly the case. It is not possible to assume a decrease in g_K during activity, since a strong membrane depolarization (up to the level of the plateau) in a medium with low Na content produced marked increase in the membrane conductance (Fig. 12, right).
2. The observation of Fig. 11, middle, and other similar observations strongly

suggest that the time course of the membrane conductance cannot be uniquely determined by the membrane potential. This casts some doubt as to the validity of one of the basic assumptions of the sodium theory (15).

3. When the membrane potential starts to fall at the end of an action potential, there is a decrease in the membrane conductance below the resting level (Fig. 6, right). According to the sodium theory an increase in g_K is expected at this moment. The voltage clamp experiments (Figs. 10 and 11) do not supply any evidence that g_{Na} may start to fall at about this time.

4. In the experiment of Fig. 12, the difference in the membrane currents for the same amount of depolarization in normal and low Na sea water does not reduce to zero during the whole period of maintained depolarization. We tried to separate the membrane currents in this experiment into I_{Na} and I_K by using the equations

$$I = I_{Na} + I_K,$$

and

$$I' = kI_{Na} + I_K,$$

(p. 458 in reference 14), in which I and I' are the membrane current in normal sea water and in low Na sea water respectively, and k is a constant that varies with membrane depolarization but not with time. There was some ambiguity in the process of determining the value of k under the assumption that the $\partial I_k / \partial t$ is zero at the onset of depolarization; we found that the value of about -0.5 was reasonable for the curves for 58 mv. depolarization. Then, using the relations

$$I_{Na} = g_{Na}(V - E_{Na}),$$

$$kI_{Na} = g'_{Na}(V - E'_{Na}),$$

$$I_K = g_K(V - E_K),$$

the values of g_{Na} , g_K and g'_{Na} were calculated. As the constants in these equations we adopted the following figures: $E_K = -10$ mv., $E_l = 10$ mv., $E_{Na} = 90$ mv., and $E'_{Na} = 48$ mv., in which E_l is the membrane potential for the leakage current. The result of calculation is presented in Table I. In this table the value of k in the middle row is the one derived from the actual data. Taking account of a possible error in the determination of k and also trying to show the dependence of the results upon the value of k , the results for three different values of k are given in the table.

The results given in the table impose certain difficulties upon the theory. The values of g'_{Na} marked with asterisks are inconsistent with theory, for a reduction of the sodium in the medium by a factor of one-sixth or less should not increase the sodium conductance of the membrane. The calculated total membrane conductance g is too large to be reconcilable with the data of Fig. 11, left, or with the result of Fig. 4. It is desirable that these points be reinvestigated by other physiologists.

Under Results the experimental facts have been described in terms of the two stable states of the membrane. Each one of these two states is characterized by its effective membrane-E.M.F. and its resistance (or conductance). The term "stable" is used to describe the tendency of the membrane to settle

down in either one of these two states. Using the symbols I and II to distinguish the two states, we denote the effective membrane-E.M.F. and the conductances in these states by E_I , g_I , E_{II} , and g_{II} . When the membrane potential is slightly raised or lowered by a short current pulse from one of these two states, the rate of the potential change in the following stage, dV/dt , is negative when $(V - E_I)$ or $V - E_{II}$ is positive, and *vice versa*; this is the mathematical expression of the stability of the states.

During activity E's and g's undergo continuous relatively slow changes. In the earlier paper (26) these changes were ascribed to the effect of some metabolic product.

TABLE I

	I_{Na}	kI_{Na}	I_K	g_{Na}	g'_{Na}	g_K	g/g_0
$k = -0.3$	-75.7	22.7	67.8	2.37	1.75	1.00	10.7*
-0.5	-65.6	32.8	57.7	2.05	2.52*	0.85	9.3*
-0.8	-54.7	43.7	46.8	1.71	3.36*	0.69	7.8*

Calculation of "sodium" and "potassium" current, I_{Na} and I_k (in $\mu A/cm^2$), and sodium and potassium conductances, g_{Na} and g_K (in $m\Omega/cm^2$), for the data of Fig. 12 at $t = 20$ msec and $V = 58$ mv. In this case,

$$I = I_{Na} + I_K + I_1 = 0,$$

and

$$I' = kI_{Na} + I_K + I_1 = 98.4 A/cm^2.$$

The total conductance g represents the sum ($g_{Na} + g_K + g_I$) and g_0 is the observed conductance in the region $0 < V < -20$ mv.

Transitions between these two stable states are induced by changes in the membrane potential. If the change in the membrane potential is large and quick, the transition takes place in a very short time (see Fig. 7). If the membrane potential is suddenly brought to an intermediate level between E_I and E_{II} , a variability or an instability of the membrane (associated with threshold excitation or abolition) follows. The interpretation of this threshold phenomenon based on the "two stable state hypothesis" will be as follows:—

When the membrane is in an unstable, intermediate condition, some part of the membrane is in state I and the remaining part is in state II. Under such circumstances, there is a continuous flow of eddy currents between the spots or patches in state I and those in state II, since $E_I \approx E_{II}$. Let α denote the fraction of the area in state II in the membrane of 1 cm^2 . Then, the portion of $(1-\alpha)$ of the membrane of a unit area is in state I. The equivalent circuit to represent this "mixed state" will then be as shown by Fig. 13B. The uncertainty in

the positions of the condensers is represented by the dotted lines. At present we do not know whether the membrane capacity is connected in parallel with the membrane-E.M.F. as postulated in the sodium theory of whether it is in series as suggested by Lorente de N6 (p. 445 in reference 19).

In threshold excitation or abolition $dV/dt = 0$ when the net membrane current I is zero. Therefore,

$$I = (1 - \alpha) g_I (V - E_I) + \alpha g_{II} (V - E_{II})$$

(which is the sum of the current flowing through the portion of the membrane in state I and the current through the part in state II) is equal to zero. In threshold excitation of a normal axon, the membrane is represented by a mixture of the patches which are in the state of full excitation (state II) and the portion at rest (state I). When the eddy currents caused by these active patches bring the average (or observable) membrane potential, V , up to 10-15 mv., the condition mentioned above (*i.e.* $dV/dt = 0$ and $I = 0$) is attained. Introducing $I = 0$, $E_I = 0$, $V = 10$ mv., $E_{II} = 110$ mv. and $g_{II}/g_I = 300$ into the equation above, it is found that α is only about 0.003 or the active patches occupy only about 0.3 per cent of the surface. The increase in the total membrane conductance at this moment is equal approximately to αg_{II} , which should be about 10 per cent of the membrane conductance at rest, g_I . Our direct measurement of the change in the membrane impedance showed that this is the right order of magnitude, but more quantitative investigation is required to clarify this point.

Based on the concept of a "mixed state," it is possible to understand the anomalous behavior of the membrane near the end of a response (Figs. 5D, 6 right, 12 left). If one assumes the rapid falling phase of a prolonged action potential to represent a mixed state, the huge value of $\partial V/\partial I$ observed in this stage will be interpreted as indicating a great dependence of α upon V (g 's and E 's being nearly independent of V).

It is interesting to point out the similarity between the two diagrams in Fig. 13. In discussing initiation and abolition (or natural termination) of an action potential, the mathematical expressions describing the behavior of the membrane potential are very similar in the two cases. Diagram A in Fig. 13 is a special case of diagram B in which both E_I and E_{II} are kept constant. The fundamental difference between the sodium theory and the two stable state hypotheses is that in the latter hypothesis E_{Na} in the sodium theory has lost its original physical meaning and is modified during the course of activity to fit the observed data. The problem whether this modification is necessary or not can be settled when we can answer the question whether or not the theory can offer a reasonable explanation for the prolonged action potentials in the squid axon, the frog myelinated nerve fiber, the cardiac muscle, and also in the crustacean muscle fiber.

It is worth mentioning finally that in Lillie's iron wire nerve model a "response" is produced by transition of the iron surface between the active and passive states. In a personal communication, Dr. U. F. Franck told us that the phenomenon of "abolition" of response can be demonstrated in the nerve model and that there is a striking similarity between the results mentioned in this paper and some of his observations on the model. The electrochemical nature of excitation of passive iron wire has been worked out by many recent investigators (1, 9).

SUMMARY

1. Intracellular injection of tetraethylammonium chloride (TEA) into a giant axon of the squid prolongs the duration of the action potential without changing the resting potential (Fig. 3). The prolongation is sometimes 100-fold or more.

2. The action potential of a giant axon treated with TEA has an initial peak followed by a plateau (Fig. 3). The membrane resistance during the plateau is practically normal (Fig. 4). Near the end of the action potential, there is an apparent increase in the membrane resistance (Fig. 5D and Fig. 6, right).

3. The phenomenon of abolition of action potentials was demonstrated in the squid giant axon treated with TEA (Fig. 7). Following an action potential abolished in its early phase, there is no refractoriness (Fig. 8).

4. By the method of voltage clamp, the voltage-current relation was investigated on normal squid axons as well as on axons treated with TEA (Figs. 9 and 10).

5. The presence of stable states of the membrane was demonstrated by clamping the membrane potential with two voltage steps (Fig. 11). Experimental evidence was presented showing that, in an "unstable" state, the membrane conductance is not uniquely determined by the membrane potential.

6. The effect of low sodium water was investigated in the axon treated with TEA (Fig. 12).

7. The similarity between the action potential of a squid axon under TEA and that of the vertebrate cardiac muscle was stressed. The experimental results were interpreted as supporting the view that there are two stable states in the membrane. Initiation and abolition of an action potential were explained as transitions between the two states.

We wish to express our gratitude to Dr. U. F. Franck, Dr. A. M. Shanes, Dr. W. H. Freygang, and Dr. C. S. Spyropoulos for their advice and criticism. We are indebted to Dr. Lorente de N6 for supplying us with a sample of tetraethylammonium chloride solution.

REFERENCES

1. Bonhoeffer, K. F., Modelle der Nervenerregung, *Naturwissenschaften*, 1953, **40**, 301.
2. Brady, R. O., Tasaki, I., and Spyropoulos, C. S., data to be published.
3. Brady, A. J., and Woodbury, J. W., Repolarization of frog ventricular fibers in low sodium, *Fed. Proc.*, 1956, **15**, 23.
4. Cole, K. S., Dynamic electrical characteristics of the squid giant axon membrane, *Arch. sc. physiol.*, 1949, **3**, 253.
5. Cole, K. S., and Curtis, H. J., Electric impedance of the squid giant axon during activity, *J. Gen. Physiol.*, 1939, **22**, 649.
6. Curtis, H. J., and Cole, K. S., Membrane resting and action potentials from the giant squid axon, *J. Cell. and Comp. Physiol.*, 1942, **19**, 135.
7. Draper, M. H., and Weidmann, S., Cardiac resting and action potentials recorded with an intracellular electrode, *J. Physiol.*, 1951, **115**, 74.
8. Fatt, P., and Katz, B., The electrical properties of crustacean muscle fibers, *J. Physiol.*, 1953, **120**, 171.
9. Franck, U. F., Models for biological excitation processes, *Progr. Biophysics*, 1956, **6**, 171.
10. Grundfest, H., Kao, C. Y., and Altamirano, M., Bioelectric effects of ions micro-injected into the giant axon of *Loligo*, *J. Gen. Physiol.*, 1954, **38**, 245.
11. Hagiwara, S., and Watanabe, A., The effect of tetraethylammonium chloride on the muscle membrane examined with an intracellular microelectrode, *J. Physiol.*, 1955, **129**, 513.
12. Hodgkin, A. L., and Huxley, A. F., Action potentials recorded from inside a nerve fiber, *Nature*, 1939, **144**, 710.
13. Hodgkin, A. L., and Huxley, A. F., Current carried by sodium and potassium ions through the membrane of the giant axon of *Loligo*, *J. Physiol.*, 1952, **116**, 449.
14. Hodgkin, A. L., and Huxley, A. F., The components of membrane conductance in the giant axon of *Loligo*, *J. Physiol.*, 1952, **116**, 473.
15. Hodgkin, A. L., and Huxley, A. F., A quantitative description of membrane current and its application to conduction and excitation in nerve, *J. Physiol.*, 1952, **117**, 500.
16. Hodgkin, A. L., Huxley, A. F., and Katz, B., Measurement of current-voltage relations in the membrane of the giant axon of *Loligo*, *J. Physiol.*, 1952, **116**, 424.
17. Hoffman, B. F., and Suckling, E. E., Cellular potentials of intact mammalian hearts, *Am. J. Physiol.*, 1952, **170**, 357.
18. Lorente de N6, R., On the effect of certain quaternary ammonium ions upon frog nerve, *J. Cell. and Comp. Physiol.*, 1949, **33**, suppl., 1.
19. Lorente de N6, R., A study of nerve physiology, Part I, *Studies from The Rockefeller Institute for Medical Research*, 1947, **131**.
20. Marmont, G., Studies on the axon membrane, *J. Cell. and Comp. Physiol.*, 1949, **34**, 351.
21. Maruhashi, J., Otani, T., Takahashi, H., and Yamada, M., On the effect of

- strychnine upon the myelinated nerve fibers of toads, *Japan. J. Physiol.*, 1956, **6**, 175.
22. Osterhout, W. J. V., Increased irritability in *Nitella* due to guanidine, *J. Gen. Physiol.*, 1942-43, **26**, 65.
 23. Overton, E., Beiträge zur allgemeinen Muskel- und Nervenphysiologie, *Arch. ges. Physiol.*, 1902, **92**, 346.
 24. Spyropoulos, C. S., Changes in the duration of the electric response of single nerve fibers following repetitive stimulation, *J. Gen. Physiol.*, 1956, **40**, 19.
 25. Tasaki, I., Nervous Transmission, Springfield, Illinois, Charles C. Thomas, 1953.
 26. Tasaki, I., Initiation and abolition of the action potential of a single node of Ranvier, *J. Gen. Physiol.*, 1956, **39**, 377.
 27. Tasaki, I., Davis, H., and Legouix, J. P., The space-time pattern of the cochlear microphonics (guinea pig), as recorded by differential electrodes, *J. Acoustical Soc. America*, 1952, **24**, 502.
 28. Trautwein, W., and Zink, K., Über Membran- und Aktionspotentiale einzelner Myokardfasern des Kalt- und Warmblüterherzens, *Arch. ges. Physiol.*, 1952, **256**, 68.
 29. Weidmann, S., Electrophysiologie der Herzmuskelfaser, Bern and Stuttgart, Hans Huber, 1956.
 30. Woodbury, J. W., Hecht, H. H., and Christopherson, A. R., Membrane resting and action potentials of single cardiac muscle fibers of the frog ventricle, *Am. J. Physiol.*, 1951, **164**, 307.

Note Added to Proof.—Recently del Castillo and Suckling (*Fed. Proc.*, 1957, **16**, 29) also expressed the view that the size of a subthreshold response is determined by the number of active patches or spots in the membrane.