

Noncatalytic Role of the FKBP52 Peptidyl-Prolyl Isomerase Domain in the Regulation of Steroid Hormone Signaling[∇]

Daniel L. Riggs,¹ Marc B. Cox,^{1†} Heather L. Tardif,¹ Martin Hessling,²
Johannes Buchner,² and David F. Smith^{1*}

Mayo Clinic Arizona, Scottsdale, Arizona 85259,¹ and Institut für Organische Chemie und Biochemie,
Technische Universität München, 85747 Garching, Germany²

Received 4 June 2007/Returned for modification 9 July 2007/Accepted 1 October 2007

Hormone-dependent transactivation by several of the steroid hormone receptors is potentiated by the Hsp90-associated cochaperone FKBP52, although not by the closely related FKBP51. Here we analyze the mechanisms of potentiation and the functional differences between FKBP51 and FKBP52. While both have peptidyl-prolyl isomerase activity, this is not required for potentiation, as mutations abolishing isomerase activity did not affect potentiation. Genetic selection in *Saccharomyces cerevisiae* for gain of potentiation activity in a library of randomly mutated FKBP51 genes identified a single residue at position 119 in the N-terminal FK1 domain as being a critical difference between these two proteins. In both the yeast model and mammalian cells, the FKBP51 mutation L119P, which is located in a hairpin loop overhanging the catalytic pocket and introduces the proline found in FKBP52, conferred significant potentiation activity, whereas the converse P119L mutation in FKBP52 decreased potentiation. A second residue in this loop, A116, also influences potentiation levels; in fact, the FKBP51-A116V L119P double mutant potentiated hormone signaling as well as wild-type FKBP52 did. These results suggest that the FK1 domain, and in particular the loop overhanging the catalytic pocket, is critically involved in receptor interactions and receptor activity.

Multiple cellular factors influence hormone-dependent activation of steroid receptors and cellular responses to hormone exposure. Our interest has focused on molecular chaperones that assemble with steroid receptors and alter receptor activity. More than a dozen chaperone and cochaperone proteins have been identified in steroid receptor complexes (23, 28); some chaperones are restricted to different stages of receptor assembly, and others compete for common assembly sites in the receptor complex. In vitro studies have identified five chaperones that are minimally necessary for efficient maturation and maintenance of the ability of the receptor to bind hormone (9, 11, 17). These are the major heat shock proteins Hsp40, Hsp70, and Hsp90 plus the cochaperone Hop, which can act as an adaptor by simultaneously binding both Hsp70 and Hsp90 (3, 30), and the cochaperone p23, which stabilizes the association of Hsp90 with receptor (15, 16). Of the multiple other cochaperones observed in receptor complexes, some have unknown functions, although others are involved in the proteolytic stability of the receptor and yet others have been shown to modulate the receptor response to hormone. Most notable of the latter are two Hsp90 cochaperones in the FK506 binding protein (FKBP) family of peptidyl-prolyl isomerase (PPIase) that have been shown to alter hormonal potency (5, 24, 25). FKBP51 was identified as a cellular factor contributing to glucocorticoid resistance in cells from New World primates

(24) by inhibiting glucocorticoid receptor (GR) response to hormone (8). In contrast, FKBP52 was found to enhance GR response to hormone (25) and to similarly enhance the receptors for androgens (AR) (4) and progesterone (PR) (31). The physiological importance of FKBP52 actions is highlighted in mouse gene knockout models. Male mice lacking the gene *Fkbp4* that encodes FKBP52 display several developmental defects in reproductive tissues consistent with androgen resistance (4, 38), and female knockout mice are infertile due to failure of embryo implantation in a maternal uterus that is resistant to progesterone (31, 32, 37).

The molecular mechanism by which either FKBP51 or FKBP52 alters receptor function has not been clearly defined. Both proteins consist of three functional domains (reviewed in reference 28): a C-terminal tetratricopeptide repeat (TPR) domain that contains the Hsp90 binding site, an N-terminal PPIase domain characteristic of FKBP family members, and an interceding FKBP-related domain that lacks PPIase activity. Three-dimensional crystallographic structures (27, 35) suggest very similar conformations within domains, although domain-domain orientations may differ somewhat between the two proteins. FKBP52 and FKBP51 share approximately 70% amino acid sequence similarity—greater within individual functional domains—and have similar enzymatic properties (21).

In a series of experiments utilizing a *Saccharomyces cerevisiae* model to study FKBP function and steroid signaling (25), FKBP51 did not on its own inhibit GR function in the absence of FKBP52; however, FKBP51 reduced the enhancement of GR function mediated by FKBP52. Additional studies in mammalian cells are consistent with an ability of FKBP51 to antagonize the actions of FKBP52 (5, 31, 34). FKBP52-dependent enhancement of receptor function requires binding of FKBP52

* Corresponding author. Mailing address: S. C. Johnson Research Building, Mayo Clinic Arizona, 13400 E. Shea Blvd., Scottsdale, AZ 85259. Phone: (480) 301-6595. Fax: (480) 301-9162. E-mail: smith.david26@mayo.edu.

† Present address: Border Biomedical Research Center, University of Texas at El Paso, El Paso, TX 79902.

[∇] Published ahead of print on 15 October 2007.

to Hsp90 and is targeted to the receptor ligand binding domain (25), which is the site for direct binding of Hsp90 in receptor heterocomplexes. FKBP51 and FKBP52 compete for a common binding site on Hsp90, and FKBP binding to Hsp90 can occur independently of the receptor (20). However, FKBP51 is recovered preferentially in some receptor complexes (1), and its association is sensitive to hormone binding (6, 29), suggesting that FKBP51 somehow detects the nature of the receptor that is associated with Hsp90.

Observations that FKBP52, but not FKBP51, binds to the microtubular motor protein dynein have been made (6, 26, 34), and a model has been proposed in which FKBP52 assists in directing GR to the nucleus subsequent to hormone binding (reviewed in reference 22). Based on the highly dynamic interaction of FKBP cochaperones with receptor complexes at physiological temperatures (20) and a recent observation that FKBP52 directly binds tubulin and inhibits microtubule assembly (2), there are several issues that remain to be resolved in the receptor transport model. Moreover, the transport model would appear to be less relevant to AR or PR, whose subcellular distributions differ from GR but whose enhancement by FKBP52 is similar (4, 31). Finally, genetic approaches in the yeast model clearly dissociate dynein dependence from FKBP52-mediated enhancement of receptor function (25). Nonetheless, FKBP52 interaction with microtubule components might be physiologically relevant to mammalian sperm flagellar function, although in an AR-independent manner (13).

Does the PPIase activity of FKBP52 play a role in receptor enhancement, perhaps by altering receptor conformation and function through isomerization of receptor prolines? Despite the fact that FKBP51 and FKBP52 have similar enzymatic activities toward model peptide substrates (21), which would seem at odds with their distinct effects on receptor activity, three lines of experimental evidence support a role for FKBP52 PPIase (25). First, deletion of the PPIase domain eliminates FKBP52's ability to enhance receptor function. Next, the drug FK506, which binds the PPIase active site and inhibits enzymatic activity, inhibits FKBP52-dependent potentiation of receptor function in yeast. Third, a double point mutation in the PPIase domain that is known to reduce PPIase activity also inhibits FKBP52-dependent potentiation. That the PPIase domain is important seems clear. On the other hand, two considerations potentially limit the certitude of current evidence supporting the need for enzymatic activity. First, FK506 is a relatively large molecule and a significant portion of the drug is excluded from the PPIase pocket (33); this excluded portion could sterically hinder interactions involving the PPIase domain independent of enzymatic activity. Second, an independent mutagenic study (12) of a related FKBP family member showed that several point mutations of enzymatically critical residues within the PPIase pocket failed to disrupt binding of the FKBP to its partner, whereas a double mutation at the corresponding residues targeted in FKBP52 did disrupt binding. Therefore, further analysis of the FKBP52 PPIase role in receptor enhancement is warranted.

To complement approaches employing directed mutagenesis of FKBP52 to disrupt function, we randomly mutagenized FKBP51 in hopes of generating gain-of-function mutants that would convert FKBP51 from an inhibitor to an activator of receptor. The characterization of such mutants could provide

alternative evidence of the mechanism by which FKBP52 acts and help to understand the relevant sequence differences that distinguish the opposing actions of FKBP52 and FKBP51.

MATERIALS AND METHODS

Yeast hormone induction assays, methods, plasmids, and strains. The yeast hormone induction assay protocol, *Saccharomyces cerevisiae* strain W303a, and the plasmids (pUC Δ ss-26X [reporter], pG/N795 [GR expression], and FKBP51, FKBP52 and FKBP51/52 chimera expression plasmids) have been previously described (25). Human AR and the mutant AR-P723S were cloned, respectively, into p424GPD and p424TEF (19). Mutations were introduced by site-directed mutagenesis (QuikChange II XL; Stratagene, San Diego, CA) into the wild-type human FKBP51 or FKBP52 gene cloned into p423GPD. Potentiation by these mutant FKBP5s was measured in strain W303a transformed with the pUC Δ ss-26X reporter plasmid and a GR or AR expression plasmid. Dihydrotestosterone (DHT) (15 nM) was used in the AR hormone induction assays, and deoxycorticosterone (DOC) (10 nM) was used in the GR assays.

Selection for FKBP51 potentiation mutants and analysis. The mutant FKBP51 library was made using error-prone PCR (GeneMorphII; Stratagene, CA) using the manufacturer's recommended conditions for high-frequency mutagenesis (5 ng target DNA per reaction). The template used was p425GPD-hFKBP51, and the primer binding sites were approximately 100 bases outside of the gene borders. The PCR product (400 ng, purified by agarose gel electrophoresis) and p424GPD vector (200 ng, linearized with EcoRI and SalI) were cotransformed into the selection strain YNK435 (*MATa ura3-52 lys2-801 ade2-101 trp1- Δ 63 his3- Δ 200 leu2- Δ 1 pdr5::GT3Z his3::GT3H*; gift of Natasha Kralli, Scripps Institute) containing the plasmid p425TEF-AR-P723S. FKBP51 potentiation mutants were selected on plates containing synthetic complete medium lacking tryptophan, leucine, and histidine (SC-WLH) supplemented with 10 nM DHT and 5 mM 3-amino-1,2,4-triazole. The concentrations of each were adjusted to maximize the growth differential between YNK435 strains expressing either FKBP51 or FKBP52. The colonies appearing after about 1 week of incubation at 30°C were purified on SC-WL plates. The mutant phenotype (potentiation of hormone signaling) was confirmed by assaying hormone-dependent expression of the β -galactosidase reporter in the selection strain. Isolates that showed increases in both hormone-dependent growth and β -galactosidase expression were confirmed by transferring the mutated FKBP51 gene into a clean genetic background. This was done by extracting the mutant FKBP51 gene using PCR amplification (LA *Taq* polymerase; Takara Shiga, Japan) from yeast lysates (Whole Cell Yeast PCR kit; MP Biochemicals, Irvine, CA). The same promoter/terminator primer pair used to construct the original mutant FKBP51 library was used in this PCR. The PCR product, purified by agarose gel electrophoresis, was cotransformed with the p424GPD vector (linearized with EcoRI and SalI) into strain W303a expressing AR-P723S and containing a plasmid-encoded hormone-responsive β -galactosidase gene (pUC Δ ss-26X). Transformants were assayed for potentiation of hormone signaling as described above. Those mutated FKBP51 genes that retained the potentiation properties in this clean genetic background were then sequenced, and interesting mutations were put in individually and in combination into the FKBP51 gene by site-directed mutagenesis.

Hormone-induced gene expression in mouse cells. Immortalized mouse embryonic fibroblasts (MEF) derived from FKBP52 knockout mice (31) were cultured in 5% CO₂ in minimum essential medium (Eagle) with Earle's balanced salts supplemented with 10% charcoal-stripped fetal bovine serum. Cells were cultured in 12-well plates until they were 80% confluent, and then they were transfected using Lipofectamine 2000 (Invitrogen, Carlsbad, CA) according to the manufacturer's instructions. The transfection mix contained the following (per well): 25 ng of a constitutive β -galactosidase-expressing plasmid (for transfection normalization); 200 ng of the pCI-neo plasmid (Promega, Madison, WI) expressing human AR; 300 ng of pCI-neo expressing FKBP51, -52, or variants; and 500 ng of a plasmid expressing firefly luciferase reporter driven by the androgen-dependent probasin promoter. Twenty-four hours after transfection, the growth medium was replaced with medium containing 30 pM DHT. Approximately 16 h later, the cells were lysed in 200 μ l M-PER mammalian protein extraction reagent (Pierce, Rockford, IL) as recommended by the manufacturer. Luciferase expression was assayed by adding 100 μ l of cell lysate to 100 μ l of luciferase assay reagent (Promega, Madison, WI). β -Galactosidase expression was assayed by adding 10 μ l of lysate to 100 μ l of Gal Screen reagent (Tropix, Bedford, MA). The 96-well plates were incubated at room temperature until maximum luminescence developed (about 5 min for the luciferase assay and 2 h for the β -galactosidase assay), and then the luminescence was measured. The

normalized level of reporter expression (luciferase RLU/ β -galactosidase RLU [RLU is relative light units]) reported is the average (\pm standard deviation [SD]) of at least three separate samples.

Hormone binding measurements in mouse cells. The 52KO MEF cell line was grown and transfected as described above in the hormone induction assay. Cells were seeded in six-well plates and cotransfected with the following constitutive expression plasmids: AR plasmid or empty vector (1 μ g DNA/well), an FKBP plasmid expressing either wild-type or mutant FKBP (0.5 μ g/well), and β -galactosidase plasmid (25 ng/well) for transfection control. Three replicate wells at each hormone concentration contained AR plasmid, and one well at each hormone concentration contained empty vector to determine nonspecific hormone binding. After 2 days, medium was removed and replaced with fresh medium containing [3 H]DHT (110 Ci/mmol; NEN, Waltham, MA) at final concentrations from 0 to 10 nM DHT. After 90 min, medium was removed, cells were washed twice in phosphate-buffered saline, and cells were lysed with a commercial lysis reagent (M-PER; Pierce, Rockford, IL). β -Galactosidase activity was measured in an aliquot of each cell lysate, and radioactivity in the remaining lysate was measured by liquid scintillation counting. Radioactive counts were normalized to the corresponding β -galactosidase activity in each sample. Specific hormone binding at each concentration of DHT was determined by subtracting radioactivity in the nonspecific sample (empty vector) from each of the three replicates containing AR and averaging the resulting values. The maximum specific binding density and dissociation constant (K_D) were calculated using Prism software (GraphPad Software, San Diego, CA).

Western immunoblots. To confirm equivalent expression of each FKBP form, Western immunoblots were performed on extracts from cells used in the induction assays. Yeast extracts were prepared either with glass beads as previously described (25) or with Y-PER yeast protein extraction reagent (Pierce, Rockford, IL) as recommended by the manufacturer. Mammalian cell lysates were prepared with M-PER as described above. The following mouse monoclonal antibodies were used: anti-FKBP51 FF1 (epitope in FK1 domain), Hi51b (epitope in TPR domain), and anti-FKBP52 Hi52d (epitope in FK1 domain). To confirm sample loading, antibody against L3 ribosomal protein (yeast lysates) and antibody against glyceraldehyde-3-phosphate dehydrogenase (GAPDH) (mammalian cell extracts) were used.

Protease-coupled PPIase assay. Proteins were expressed in the *Escherichia coli* strain BL21. Protein purification and PPIase assays were performed as described earlier (21). PPIase assays were performed using a protease-coupled assay. In brief, various concentrations of the purified PPIase were combined with the synthetic peptide substrate *N*-succinyl-Ala-Ile-Pro-Phe-*p*-nitroanilide (50 μ M final concentration) in 40 mM HEPES, pH 7.5, supplemented with 1 mg/ml chymotrypsin. The fraction of peptide containing a *cis*-proline peptide bond is cleaved by protease in a slow reaction that allows determination of the rate of proline isomerization and catalytic efficiency.

RESULTS

Role of PPIase activity in potentiation of hormone signaling.

In our initial characterization of potentiation by FKBP52 (25), we presented evidence that supported a role for PPIase activity in receptor potentiation. FK506, which binds in the PPIase pocket, inhibited potentiation. Likewise, a double point mutation of FKBP52 involving amino acids Phe-67 and Asp-68 (FD67DV) inhibited both PPIase activity and receptor potentiation. We thus suggested that an X-Pro peptide bond in the receptor was isomerized by FKBP52 to enhance hormonal signaling. However, there are reports that FK506 can inhibit FKBP function not only by inhibiting PPIase activity but also by sterically blocking productive contacts with a binding partner (12). Additionally, mutation of Phe-67 and Asp-68, which are highly conserved among PPIases in the FKBP family, could potentially alter PPIase domain conformation and surface interaction with a nonsubstrate partner.

To further examine the role of FKBP52 PPIase in potentiation, we have now tested the effects of additional point mutations in conserved residues that are generally important for enzymatic activity (Fig. 1). Unlike residues Phe-67 and Asp-68, which are positioned around the mouth of the PPIase pocket,

amino acids Tyr-57, Trp-90, and Phe-130 are located within the hydrophobic PPIase pocket (Fig. 1A). As seen with corresponding mutations in other FKBP family members (reviewed in reference 10), we confirmed that individual mutation of these amino acids greatly impairs PPIase activity (Fig. 1B). To determine the effects of mutation on receptor potentiation, we first used a yeast model (Fig. 1C). Yeast strains were stably transformed with three plasmids: one expressing the steroid hormone receptor, a second containing a β -galactosidase reporter gene transcribed from a hormone-inducible promoter, and a third expressing wild-type or mutant FKBP. As we previously reported (25), the FD67DV double mutation abolishes FKBP52-dependent potentiation of GR (Fig. 1C, left panel) and partially reduces AR potentiation (Fig. 1C, right panel). In contrast, the Y57A, F67Y, W90L, and F130Y mutations have no effect on FKBP52 potentiation of either GR or AR signaling. None of the mutations significantly altered the steady-state levels of expressed proteins as measured by Western blot analysis of yeast extracts.

To confirm these results in a more relevant mammalian model, we examined mutants in a mouse embryonic fibroblast cell line derived from FKBP52 knockout mice (31). This immortalized 52KO MEF cell line was transiently transfected with four plasmids: an AR expression plasmid, a plasmid containing a firefly luciferase gene transcribed from the AR-responsive probasin promoter, a constitutive β -galactosidase-expressing plasmid (for normalizing transfection efficiency), and a plasmid expressing FKBP. The level of hormone-induced reporter expression was measured in the presence of various FKBP variants (Fig. 1D). As in the yeast model, FKBP51 had a minimal effect on signaling, while FKBP52 stimulated AR transactivation of the reporter gene more than fivefold. The three PPIase-deficient mutants—F67Y, W90L, and F130Y—all potentiated AR transactivation. These results establish that PPIase activity per se is not required for potentiation. By analogy to other well-characterized FKBP5s, perhaps FK506 sterically interferes with recognition of an FKBP52 binding partner; similarly, the FD67DV double mutant, in which surface residues along the lip of the PPIase pocket are altered, might fail to interact with a binding partner.

Genetic selection for FKBP51 gain-of-potentiation mutations. A possible explanation for the functional differences between the FKBP5s is that FKBP51 lacks one or more residues present in FKBP52 that are critical for productive interaction with a binding partner. Here we have used yeast genetics to identify such residues by selecting for gain-of-function mutations in FKBP51 that enable it to potentiate hormone signaling in a manner similar to that of FKBP52.

In the yeast strain used for this selection (YNK435; see Materials and Methods for details), the *HIS3* gene, which is required for histidine biosynthesis, is transcribed from a weak promoter having an adjacent upstream hormone response element (Fig. 2). To inhibit growth due to leaky expression of the *HIS3* construct in the absence of hormone, the His3p inhibitor 3-amino-1,2,4-triazole was added to the growth medium. In strain derivatives stably expressing AR, growth in medium lacking histidine was dependent upon the ligand dihydrotestosterone, and growth dramatically increased when FKBP52 was coexpressed. To further enhance this conditional, hormone-dependent growth, our selection strain expresses AR

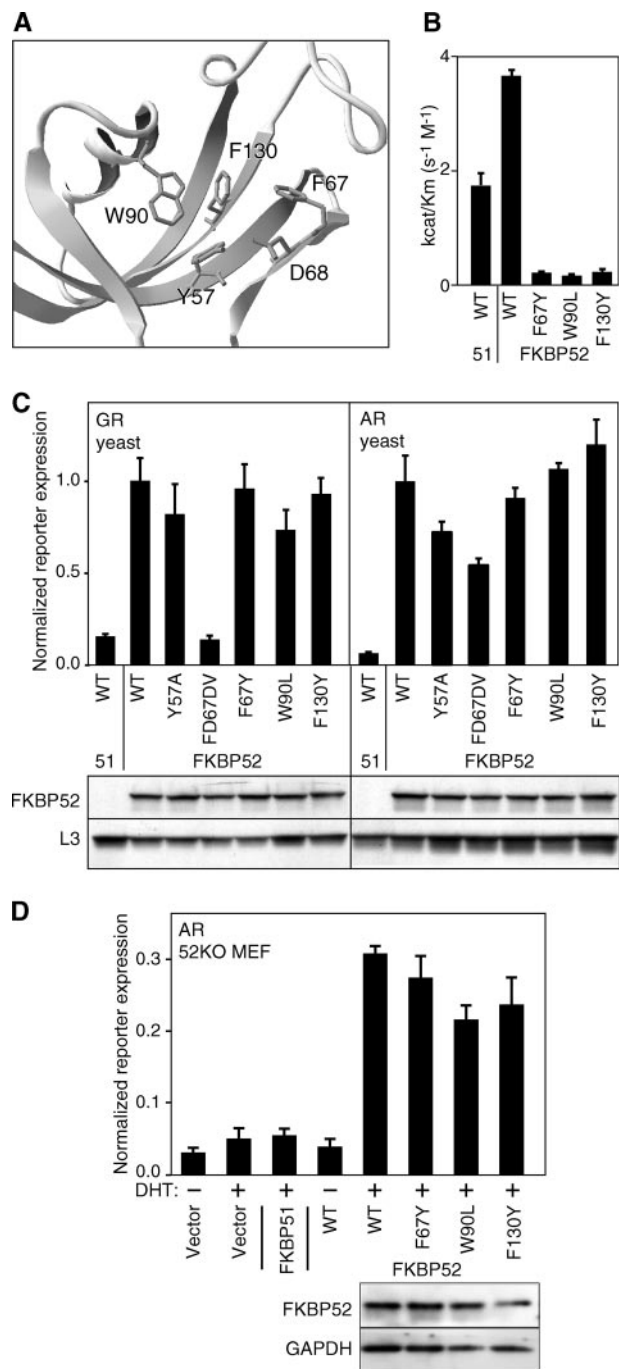

FIG. 1. PPIase activity is not required for potentiation by FKBP52. (A) As derived from an X-ray crystallographic structure of FKBP52 (35), the portion of the FK1 domain that highlights amino acids targeted by site-directed mutagenesis is depicted. For reference, this view is looking down into the PPIase pocket; the overhanging loop discussed later is in the upper right corner. (B) PPIase activity was determined for wild-type (WT) FKBP51 (51), FKBP52, and three FKBP52 point mutants using the protease-coupled assay described in Materials and Methods. The data are averages (plus SDs [error bars]) of four independent experiments. (C) Yeast strains were transformed with a hormone receptor expression plasmid, a reporter plasmid, and plasmids expressing the indicated FKBP52 variant. Reporter gene expression was induced by the addition of DOC (GR) or DHT (AR), and the differential rate of reporter gene induction was measured over a 40-min time interval starting 75 min postinduction (details in reference 25). The level of reporter expression

with the P723S point mutation, originally identified in an individual with complete androgen insensitivity syndrome (7), which is hyperdependent on FKBP52 for hormone-induced activity (4). In medium supplemented with DHT, little growth was observed in yeast strains expressing FKBP51, while strains expressing FKBP52 displayed robust growth (Fig. 2A).

To generate FKBP51 gain-of-function mutants that support DHT-dependent yeast growth, we reasoned that multiple mutations in FKBP51 might be necessary, so random mutagenesis was done under conditions expected to produce three to five mutations per PCR product (Fig. 2B). Cells transformed with the mutant FKBP51 libraries were plated on the selective growth medium and incubated until distinct colonies appeared. As an independent marker for AR activity, the selection strain also contains a second plasmid carrying a hormone-responsive β -galactosidase reporter gene; thus, the FKBP51 mutant phenotype was independently confirmed and quantified by measuring DHT-induced β -galactosidase activity. To confirm that mutations in FKBP51 (rather than inadvertent genomic mutations) caused the mutant phenotype, the mutant FKBP51 gene was transferred into a different yeast strain containing a different hormone-inducible β -galactosidase reporter and AR-P723S. If hormone response was enhanced by the mutant FKBP51, the mutant gene was rescued by colony PCR and sequenced.

We isolated numerous independently derived mutants with the expectation that key mutations would repeatedly arise. A total of 25 gain-of-function mutants were isolated from eight independent libraries; of these, 11 had mutations in one of three residues located within a 6-amino-acid stretch in the FK1 domain: A116V/T, L119P, and S124P (Fig. 3). With the exception of one A116T mutation, each was isolated multiple times from independent libraries. The three residues at positions 116, 119, and 124 are all located in a loop that extends over the PPIase pocket (Fig. 4B and C). The amino acid sequences of FKBP51 and FKBP52 diverge only at positions 119 and 124 in this loop (Fig. 4D, arrows). Interestingly, the selected FKBP51 mutations at position 119 or 124 all introduced proline residues, as found in FKBP52 and other FKBP family members.

Characterization of the mutants. To confirm the roles of amino acids in positions 119 and 124, corresponding point mutations were made in wild-type FKBP51, and converse mutations were generated in FKBP52. Initially, the FKBP mu-

was normalized to signaling levels of the strains expressing wild-type (WT) FKBP52. In all of the yeast induction assays, each bar is the average expression rate (plus SD [error bar]) of three independent cultures of a representative transformant. To confirm protein levels, extracts prepared from these strains were analyzed by Western analysis for expression of exogenous FKBP52 and, as a loading control, endogenous ribosomal subunit L3. 51, FKBP51. (D) 52KO MEF cells were cotransfected with plasmids encoding AR, a hormone-responsive luciferase reporter gene, the indicated FKBP, and β -galactosidase for transfection normalization. After treatment with either vehicle (-) or DHT (+) for 24 h, cell lysates were prepared and assayed for luciferase and β -galactosidase activities. Each bar represents the average reporter expression (luciferase activity/ β -galactosidase activity) (plus SD [error bar]) of three replicates. Cell extracts were further analyzed by Western blotting for expression of exogenous FKBP52 and, as a loading control, endogenous GAPDH.

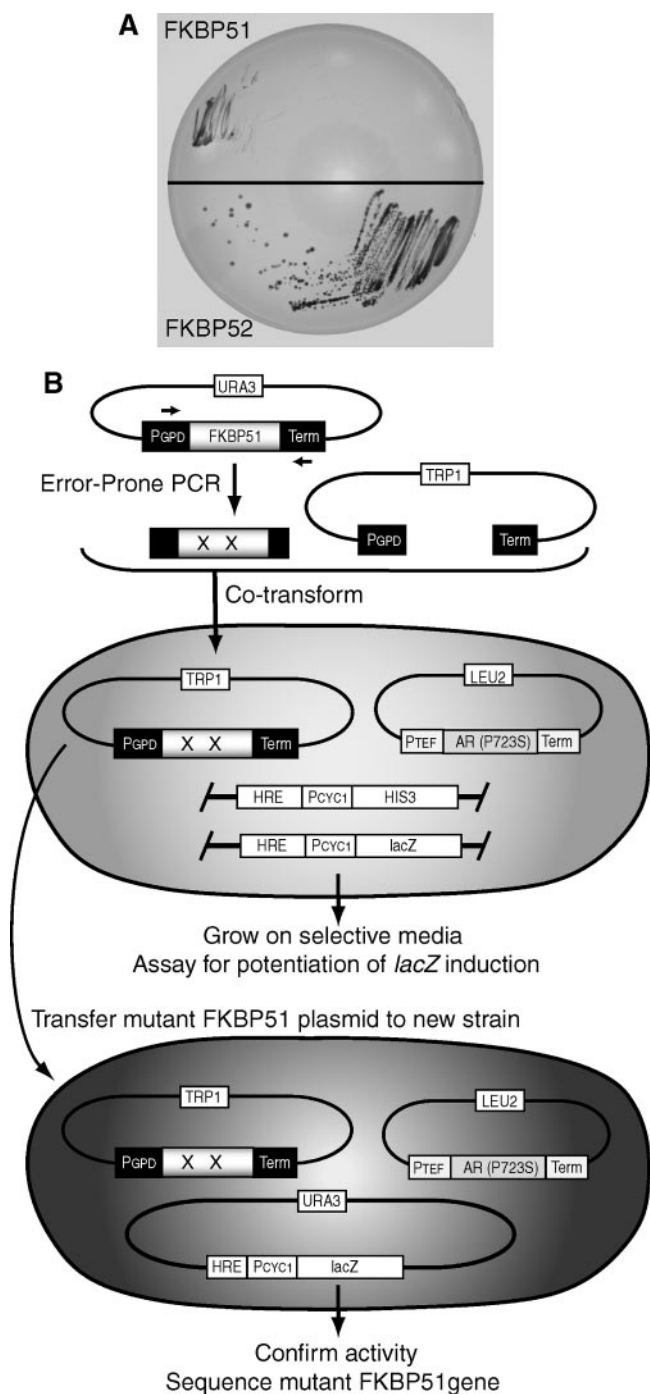

FIG. 2. Selection scheme for FKBP51 potentiation mutants. (A) Yeast strains containing a hormone-inducible *HIS3* gene and expressing AR plus either FKBP51 or FKBP52 were grown on selection medium containing a growth-limiting concentration of DHT, as described in Materials and Methods. Yeast grows well only in the presence of FKBP52, which potentiates AR activity. (B) Libraries of random FKBP51 mutants were independently generated by error-prone PCR using primers (horizontal arrows) binding upstream in the vector yeast GAPDH promoter (PGPD) or downstream in the transcriptional terminator (Term). Mutant libraries were cotransformed with a gapped, linearized vector such that homologous recombination between the common promoter and terminator regions on these fragments (about 100 nucleotides each) reconstitutes a *TRP1*-marked FKBP51 expression plasmid. The parental strain harbors a *LEU2*-marked AR-P723S expression plasmid and integrated *HIS3*

and *lacZ* reporter genes driven by hormone-responsive promoter element (HRE). Transformants were plated on selective medium supplemented with 3-amino-1,2,4-triazole and DHT. To confirm that growth was dependent on mutant FKBP51, colony PCR was used to synthesize the FKBP51 gene from yeast lysate, and the PCR product was cotransformed with a gapped vector (as in the initial strain construction) into an independent parental strain expressing AR-P723S and containing a *lacZ* reporter plasmid. From secondary strains exhibiting the gain-of-function phenotype, the FKBP51 gene was sequenced to identify relevant mutations.

tants were analyzed for potentiation in yeast expressing either wild-type GR or AR (Fig. 5A). In this model system, the residue at position 119 is critical for potentiation: the L119P mutation in FKBP51 enabled it to potentiate signaling three- to fivefold, while the converse P119L mutation in FKBP52 decreased signaling to about half the level of wild-type FKBP52. Importantly, the effects of FKBP mutants on receptor activity seen in the yeast model are replicated in mammalian cells. In 52KO MEF cells expressing wild-type AR (Fig. 5B), reporter gene expression was stimulated 15-fold in the presence of FKBP52 compared to basal expression in the presence of wild-type FKBP51; potentiation activity was gained by the mutant FKBP51-L119P and diminished in the converse mutant FKBP52-P119L. As seen in previous studies, FKBP forms accumulated to similar levels and did not affect the steady-state level of receptor protein (Fig. 5B, Western immunostained panels). A similar analysis was performed with GR in 52KO MEF cells (results not shown), but GR differs from AR in that FKBP51 actively represses GR function in mammalian cells (5, 8, 34). Nonetheless, mutant FKBP5s had intermediate effects on GR activity between the attenuation observed with FKBP51 and the potentiation observed with FKBP52.

The mutations at residue 124, whether alone or in combination with mutations at residue 119, had little effect on GR or wild-type AR activity in both yeast and MEF cells (Fig. 5A and B). Although the mutation at position 124 does not alter hormone signaling by wild-type receptors, we found that the FKBP51-S124P mutation does enhance signaling by the hyperresponsive AR-P723S (data not shown), which could explain its isolation by genetic selection in yeast expressing AR-P723S. Consistent with the lack of correlation between PPIase activity and potentiation, the combined L119P S124P mutation actually reduces PPIase activity approximately 40% (data not shown) while enhancing receptor activity four- to fivefold over wild-type FKBP51. None of the FKBP mutations significantly alters the level of FKBP protein or coexpressed receptor protein as judged by Western immunostaining of MEF lysates (Fig. 5B).

Previous reports have shown that the presence of FKBP51 or FKBP52 in steroid receptor complexes can alter receptor hormone binding affinity (5, 8, 25, 31). An FKBP52-mediated increase in receptor hormone binding affinity can explain, at least in part, potentiation of hormone-dependent gene transactivation. In Fig. 5C, we present hormone binding curves generated from intact 52KO MEF cells coexpressing AR and one of the wild-type or mutant FKBP forms. AR hormone binding affinity was increased approximately fivefold in cells expressing exogenous FKBP52 ($K_D = 1.7 \pm 0.2$ nM) compared to cells expressing

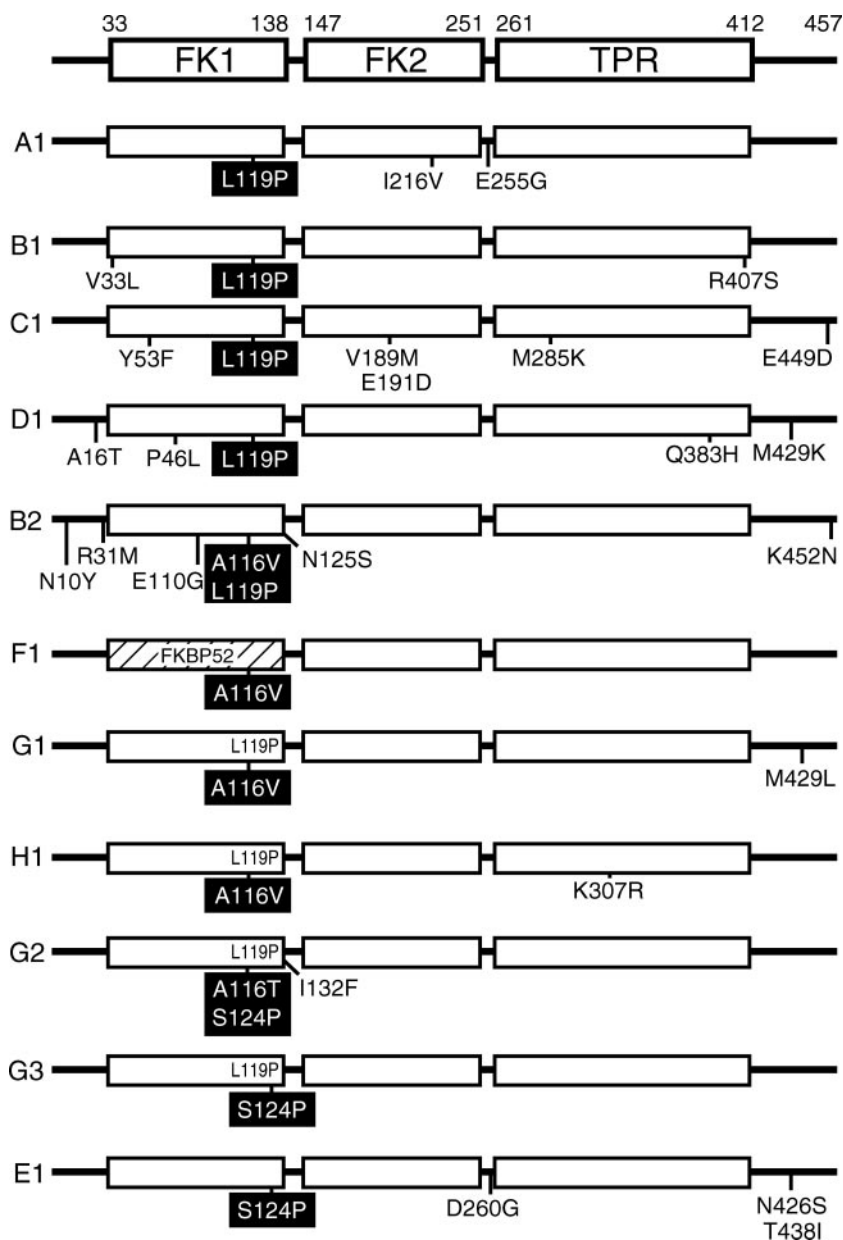

FIG. 3. FKBP51 potentiating mutants isolated in the selection. The top diagram represents the domain arrangement of FKBP51 in a linear manner with amino acid numbering at the domain boundaries. Isolated mutants are aligned below. Each mutant is identified by the library from which it was isolated (libraries A to H) and an isolate number. The libraries were produced using one of three different plasmid templates in error-prone PCR: the wild-type FKBP51 gene (libraries A to E), the FKBP51 (L119P) gene (libraries G and H), or a chimeric gene containing FKBP52-FK1 attached to FKBP51-FK2 and -TPR domains (library F). Mutations of particular interest are shown in black boxes.

FKBP51 ($K_D = 9.3 \pm 0.8$ nM). FKBP51-L119P increased AR hormone binding affinity ($K_D = 3.7 \pm 0.9$ nM) compared to wild-type FKBP51, and FKBP52-P119L modestly decreased affinity ($K_D = 2.2 \pm 0.4$ nM) compared to wild-type FKBP52; both changes correlate well with the effects of mutant proteins on AR-dependent gene activation (Fig. 5B). The calculated maximum specific binding density values in all cases were statistically equivalent, which is consistent with equivalent AR protein levels in various MEF extracts (Fig. 5B).

Both FKBP5s have alanine in position 116. In yeast and MEF cells, the A116V mutation in wild-type FKBP51 only modestly

increased AR signaling (Fig. 6). This level of potentiation is insufficient to be readily detected in our genetic screen. On the other hand, A116V in combination with L119P displays receptor potentiation fully equivalent to FKBP52. The A116V mutation was selected when either the template used for random mutagenesis already contained P119 (Fig. 3, mutants F1, G1, H1, and G2), or the A116V and L119P mutations were simultaneously introduced (mutant B2). A116V mutation of FKBP52 does not significantly increase its ability to potentiate AR, suggesting that FKBP52 is already optimized for this function.

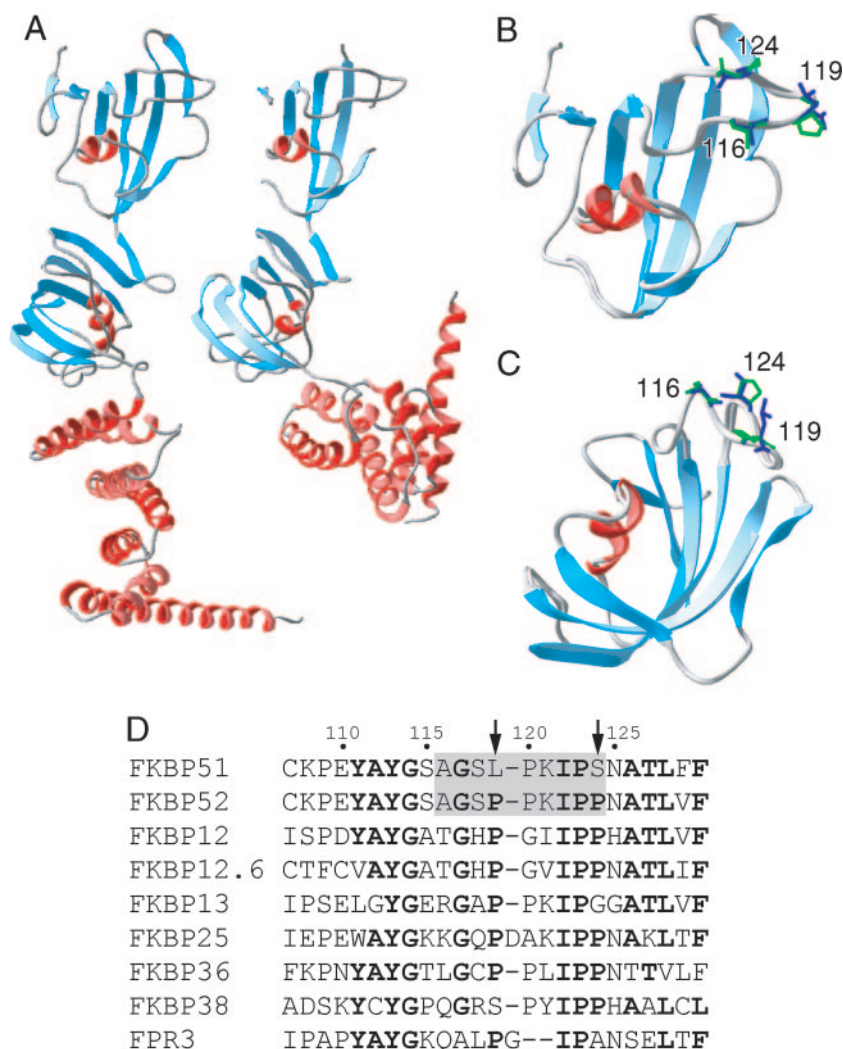

FIG. 4. Locations of the FKBP51 A116V, S119P, and S124P mutations in the proline-rich loop. (A) Crystal structures of FKBP51 (left) and FKBP52 (right) are aligned; the respective FK1 domains are located at the top of either structure. (B and C) In an overlay of FK1 domains, amino acids at positions 116, 119, and 124 are highlighted in green (FKBP52) or dark blue (FKBP51). All three amino acid positions are within a loop overhanging the PPIase pocket. (D) Segments of amino acid sequences from various FKBP family members are aligned. Amino acids in boldface type are conserved in most of the FKBP family members. Amino acids within the overhanging loop of FKBP51 and FKBP52 are indicated by the shaded box. Note that the only differences between FKBP51 and FKBP52 within the loop region are at positions 119 and 124 (arrows). Gaps introduced to maximize alignment are indicated by dashes.

Mapping other relevant differences between FKBP51 and FKBP52. These results indicate that P119 of FKBP52 plays a critical role in the ability to potentiate GR or AR signaling; however, an L119P mutation does not fully convey to FKBP51 the level of receptor potentiation observed with FKBP52. This raises questions about other amino acid differences that relate to receptor potentiation ability. Since genetic selection for FKBP51 gain-of-function mutants did not clearly identify relevant amino acid differences other than those in the FK1 loop, we used a domain swap approach to map protein regions that influence potentiation (Fig. 7). We first constructed a series of chimeras between FK1 and the FK2-TPR domains, as diagrammed at the top of Fig. 7A. One set of chimeras contained the wild-type FK1 domain (WT), and the other set contained an FK1 with the indicated point mutation. In yeast, the FK1 domain appears to be the sole difference with respect to po-

tentiation of AR (Fig. 7A, left panel). A chimera containing the FKBP52 FK1 domain and FKBP51 FK2-TPR domains (WT-52/51, bar 5) resulted in levels of potentiation equivalent to that observed with intact FKBP52 (bar 7), and the converse chimera containing FKBP51 FK1 and FKBP52 FK2-TPR (WT-51/52, bar 3) showed no potentiation, similar to intact FKBP51 (bar 1). In contrast to yeast results, residues outside the FK1 domain are required for full potentiation in 52KO MEF cells (Fig. 7A, right panel). The 51/52-WT (bar 3) and 52/51-WT chimeras (bar 5) both had intermediate levels of potentiation between FKBP51 and FKBP52.

We next examined chimeras containing an L119P or P119L mutation to determine whether the amino acid at position 119 exclusively confers the functional difference between FK1 domains. In both yeast and MEF cell systems, introducing the L119P mutation into the FKBP51/52 chimera (L119P-51/52,

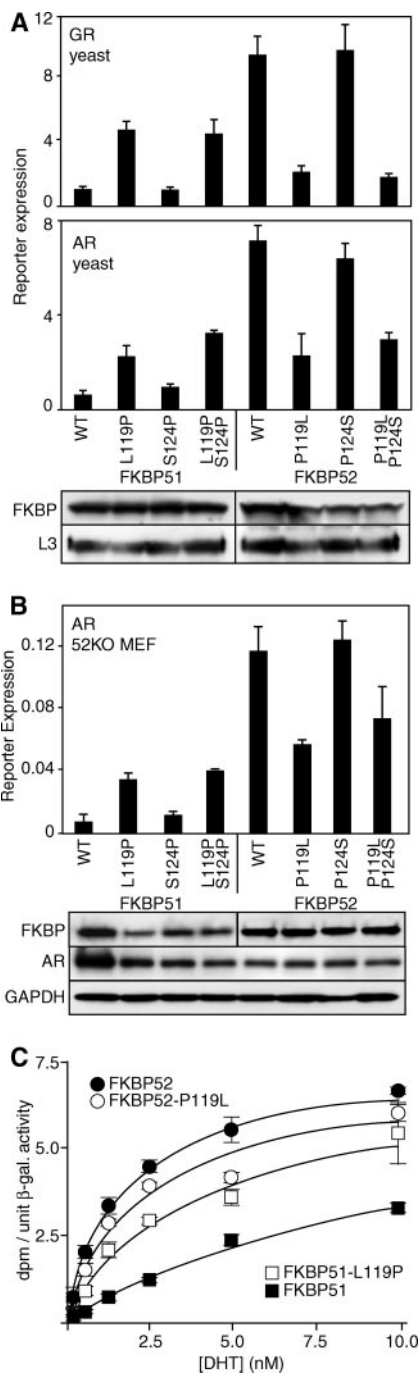

FIG. 5. Functional analysis of amino acids at positions 119 and 124. (A) Hormone-dependent reporter gene activity was measured in yeast strains expressing wild-type GR (top) or AR (bottom) plus the indicated FKBP. Protein expression levels were monitored by Western immunostaining for the introduced FKBP and the endogenous ribosomal subunit L3. WT, wild type. (B) FKBP activities were similarly measured in transfected 52KO MEF cells expressing wild-type AR and a hormone-dependent luciferase reporter. Protein expression levels were monitored by Western immunostaining for the introduced FKBP, AR, and endogenous GAPDH. (C) Hormone binding by AR was measured in intact 52KO MEF cells cotransfected with plasmids expressing the indicated FKBP form, β-galactosidase as a transfection control, and either AR (total hormone binding) or empty vector (nonspecific binding). Intact cells were incubated with [³H]DHT at the concentrations shown and extracted into aliquots for liquid scintillation counting or measurement of β-galactosi-

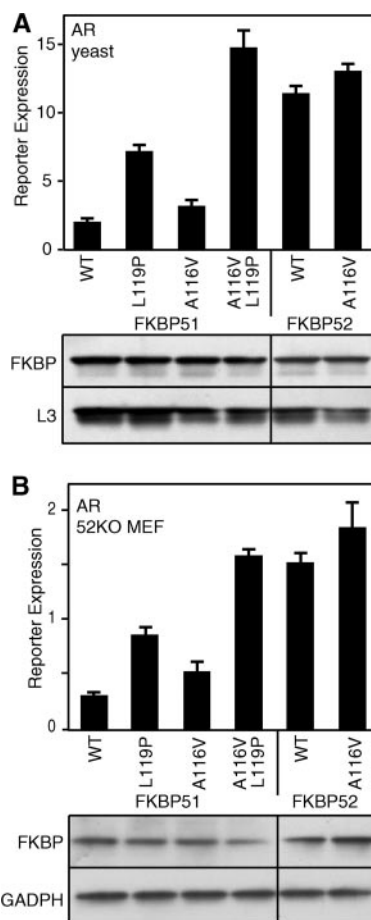

FIG. 6. Functional analysis of FKBP A116V mutations. AR signaling and FKBP expression was assayed in yeast (A) or in 52KO MEF (B) background. WT, wild type.

bar 4 in either panel of Fig. 4A) brought potentiation up to wild-type FKBP52 levels. The converse chimera P119L-52/51 (bar 6 in both panels) largely abolished potentiation in both systems. Activity differences in chimeric proteins cannot be attributed to differences in FKBP protein levels in yeast or MEF (Fig. 7A, lower panels). These results indicate that the FK1 domain—and more particularly the amino acid at position 119—is critical for potentiation and largely distinguishes FKBP52 and FKBP51 activities measured in these cellular assays.

As noted above (Fig. 7A, right panel), sequences outside the FK1 domain appear to contribute to potentiation in 52KO MEF cells. Additional chimeras were generated to map these extraneous features to either the FK2 or TPR domain (Fig. 7B). The chimera containing the FK1 and FK2 domains of FKBP52 and the TPR of FKBP51 (52/52/51, bar 4) has activity approximately equal to that of intact FKBP52, suggesting that

dase activity. Bound radioactivity (dpm – decays per minute) was normalized to β-galactosidase (β-gal.) activity in each sample. Each data point represents the average specifically bound dpm (total dpm – nonspecific dpm) for three replicate samples.

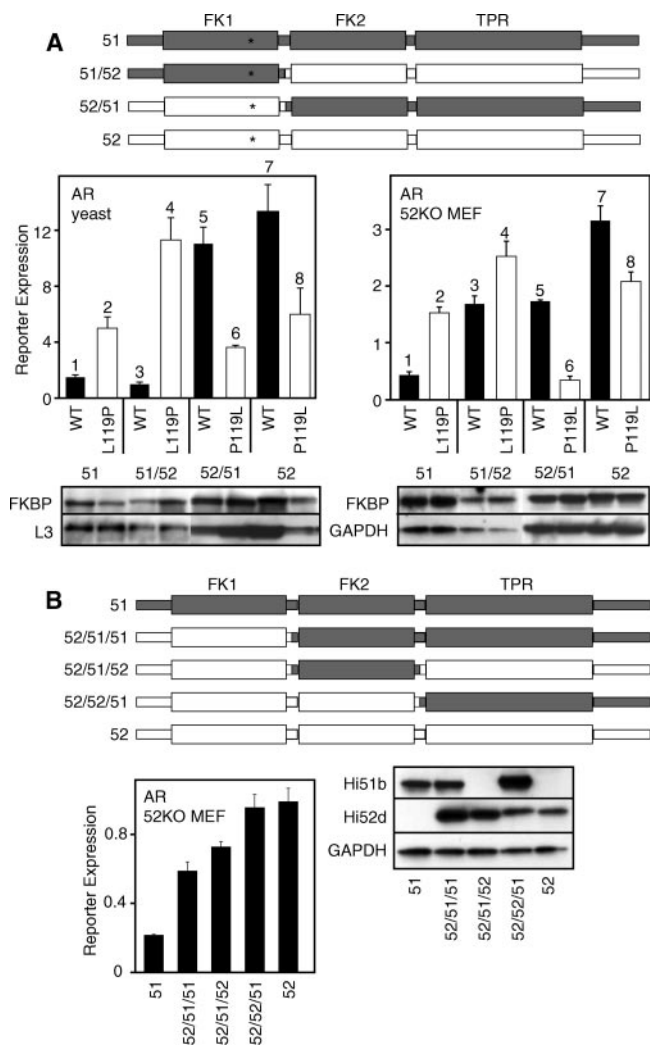

FIG. 7. Functional analysis of FKBP chimeras. (A) As diagrammed at the top of the figure, chimeric proteins were generated by exchanging FK1 domains between FKBP51 (51) (shaded) and FKBP52 (52) (white). One set of chimeras contained converse point mutations at position 119 (indicated by asterisk in diagram), and another set lacked the mutation. The activities and expression levels of the FKBP constructs were assayed in yeast (left-hand panels) or in 52KO MEF (right-hand panels) containing wild-type AR and an appropriate hormone-dependent reporter. Each pair of bars shows reporter activity in the presence of FKBP lacking a mutation at 119 (WT; black bars) or containing the indicated point mutation (L119P or P119L; white bars). (B) A similar analysis was performed using chimeras involving swaps among the FK2 and TPR domains, as indicated by the diagram at the top of the panel. The activities and expression levels of FKBP constructs were assayed in 52KO MEF expressing wild-type AR and a hormone-dependent luciferase reporter. Chimeras were detected in cell extracts by Western immunostaining with monoclonal antibodies specific for either the FKBP51 TPR domain (Hi51b) or FKBP52 FK1 domain (Hi52d).

the FK domain region of FKBP52 is sufficient for full potentiation and that TPR domain differences are not functionally relevant to potentiation. On the other hand, the chimera combining the FK1 and TPR domains of FKBP52 with the FK2 domain of FKBP51 (52/51/52, bar 3) has somewhat greater activity than the chimera containing only the FK1 domain of

FKBP52 (52/51/51, bar 2), so unique interactions between FK2 and TPR domains, as suggested by FKBP52 and FKBP51 crystal structures, might influence FK1-mediated potentiation. Activity differences in chimeric proteins cannot be attributed to different levels of protein expression (Fig. 7B, lower right panel).

DISCUSSION

FKBP52 can potentiate hormone-dependent transcriptional activity of steroid receptors. Whereas the physiological importance of FKBP52 function in mammalian male and female reproductive development has been demonstrated, the mechanistic basis for receptor potentiation is poorly understood. It is necessary for FKBP52 to bind Hsp90 as a means to assemble with receptor complexes, and the N-terminal PPIase domain of FKBP52, termed FK1, is necessary. Previous findings were that FK506, which binds the PPIase pocket, and combined mutagenesis of two amino acids in FK1 abrogate receptor potentiation by FKBP52 (25). FK506 is known to inhibit PPIase activity, leading to our prior conclusion that PPIase activity is likely important for receptor potentiation. Here, however, we show through directed mutagenesis of additional amino acids critical for PPIase activity that enzymatic activity of FK1 is not required for receptor potentiation (Fig. 1). Nonetheless, we provide additional evidence for the critical importance of FK1 for potentiation of receptor activity.

FKBP51, which despite its many similarities to FKBP52 does not potentiate receptor activity, was randomly mutated, and a yeast genetic screen was devised to identify FKBP51 mutants that gain potentiation activity (Fig. 2). The major class of gain-of-function mutations identified by the genetic screen (summarized in Fig. 3) localized to a surface loop of FK1 that overhangs the PPIase active site (Fig. 4). Strikingly, interconversion of a single amino acid within this loop—Pro119 in FKBP52 and Leu119 in FKBP51—can largely confer potentiation activity to FKBP51 or ablate potentiation by FKBP52 in either the yeast model or in mouse cells (Fig. 5 and 6). A second loop mutation at nearby position 124 (S124P) was identified in the yeast screen as conferring some potentiation activity to FKBP51, but this activity was evident only vis-à-vis the AR-P723S point mutant, not with wild-type AR or GR (Fig. 5). Further implicating the loop as important for potentiation activity, two point mutations of amino acid 116 (A116V or A116T) were isolated that elevated potentiation by the gain-of-function FKBP51 L119P mutant to the level normally observed with wild-type FKBP52 (Fig. 6). Since FKBP51 and FKBP52 both naturally contain alanine in loop position 116, we tested whether an FKBP52-A116V mutation would have potentiation activity exceeding that of wild-type FKBP52 (Fig. 6); as only a small increase in potentiation was observed, we conclude that FKBP52 potentiation activity is already optimal.

The FKBP51 gain-of-function mutant results highlight the importance of the PPIase loop, in particular amino acid position 119, in FKBP-dependent potentiation of AR and GR activities. FKBP51-L119P activity can be optimized by combining with a novel mutation at position 116 or combining the mutant FK1-L119P domain with the FK2 and TPR domains of FKBP52 (Fig. 7), demonstrating that FKBP52-unique se-

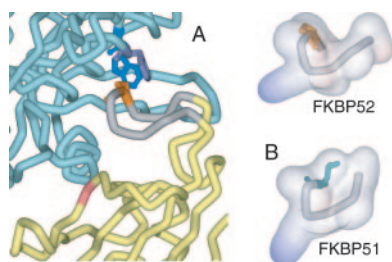

FIG. 8. FK loop interactions. (A) The region of interaction between FKBP12 (yellow chain) and the cytoplasmic domain of the TGF- β receptor (cyan chain) is depicted from a solved cocrystallographic structure (Protein Data Bank entry 1B6C; 14). The loop overhanging the PPIase pocket of FKBP12 (gray segment) contains P88 (orange side chain), which corresponds to P119 of FKBP52. Also highlighted in FKBP12 is D37 (red segment), which corresponds to D68 in FKBP52. Highlighted in the TGF- β receptor are F243 (purple side chain) and W242 (dark blue side chain) that interact with P88 of FKBP12. (B) Space-filling depictions are shown for the FK1 overhanging loop of FKBP52 containing P119 (orange side chain) and of FKBP51 containing L119 (blue-green side chain).

quences outside the FK1 domain—probably in FK2—normally contribute to potentiation capacity.

PPIase loop interactions. To gain some insight into the nature of potential interactions by FKBP52 FK1, we refer to observations of protein-protein interactions involving single-domain FKBP PPIases. Several FKBP-protein interactions have been shown to be independent of PPIase enzymatic activity yet still involve residues in or near the PPIase active pocket. FKBP12 and FKBP13 form FK506-dependent complexes with calcineurin (18), which inhibits calcineurin activity and forms the basis for FK506-mediated immunosuppression. Calcineurin binding involves an exposed region of FK506 and FKBP residues outside the PPIase pocket. Furthermore, FKBP12 and FKBP12.6 interactions with ryanodine receptor (36) and FKBP12 binding to the transforming growth factor β (TGF- β) receptor (14) do not require PPIase activity, yet in each of these cases FK506 inhibits protein interaction.

The cocrystallographic structure of FKBP12 in complex with the TGF- β receptor (Fig. 8A) illustrates features that could be analogous to FKBP52 interactions with the steroid receptor. FKBP12 (yellow chain) binds the C-terminal domain of the TGF- β receptor (blue chain) through FKBP loop amino acids (gray region) as well as FKBP residues surrounding the PPIase pocket. Note that FKBP12 aspartic acid 37 (red), which corresponds to D68 in the FK1 domain of FKBP52, lies along the PPIase pocket and participates in interactions with the TGF- β receptor. By analogy, alteration of this amino acid and the adjacent phenylalanine in the FD67DV mutant of FKBP52, aside from impairing enzymatic activity, might disrupt FK1 interactions with the receptor and explain why we observe loss of GR potentiation (25) (Fig. 1C). In the loop region, mutation of FKBP12 amino acids 89 and 90 (equivalent to positions 120 and 121 in FKBP52, as shown in Fig. 4D) was shown to disrupt binding of FKBP12 to the TGF- β receptor. Tryptophan and phenylalanine side chains from the TGF- β receptor (Fig. 8A, blue and purple) are seen to interact with FKBP12-P88 (orange), which corresponds to FKBP52-P119. The phenylalanine side chain (purple) actually projects into a hydrophobic notch formed along the top of the loop.

A close comparison of the corresponding loops in FKBP52 and FKBP51 (Fig. 8B) reveals a striking structural difference due to the respective amino acids at position 119. Similar to P88 in the loop of FKBP12, P119 of FKBP52 projects outward to form a notch along the exposed loop surface (Fig. 8B, top). In contrast, L119 in FKBP51 projects inward, occluding the notch (Fig. 8B, bottom). It is reasonable to speculate that FKBP52, in a manner analogous to FKBP12 and TGF- β receptor interaction, forms a functionally important contact via the FK1 hydrophobic notch with another component in the steroid receptor complex. FKBP51 would lack this contact due to the altered loop conformation imposed by substitution of leucine for proline at position 119.

Mechanism for FKBP52-mediated potentiation of steroid receptor activity. We propose that the FKBP52 FK1 domain, via the notch formed by P119 in the overhanging loop, forms a specific contact with the receptor ligand binding domain (LBD) in the context of Hsp90 heterocomplexes and that this contact potentiates receptor response to hormone. Several lines of evidence factor into this model. First, although FKBP52 binds Hsp90 directly and this binding is required for potentiation, we do not believe the relevant FK1 contact for potentiation is with Hsp90 itself. The reason is that FKBP52 selectively potentiates the activities of AR, GR, and PR without altering the activity of estrogen receptor (25, 31) or mineralocorticoid receptor (unpublished observations). An FKBP52-induced change in Hsp90 function would seem likely to affect all Hsp90-bound steroid receptors in a similar manner. Furthermore, we have previously shown with chimeric steroid receptors (25) that FKBP52-dependent potentiation localizes to the receptor LBD. The purpose, we presume, of Hsp90 binding by FKBP52 is to properly localize and orient the FK1 domain for productive interaction with the receptor LBD. We have been unable to detect direct interaction between FKBP52 and steroid receptor in the absence of Hsp90, but others have reported such an interaction (26). FK1 interaction with the LBD is likely weak except as mediated by Hsp90.

Related to the roles of Hsp90 binding and FK1 interactions, we considered whether FKBP12, which shares a proline equivalent to P119 in the overhanging loop and other structural similarities to FKBP52-FK1, might functionally substitute for FK1. FKBP12, like FKBP52 that lacks Hsp90 binding, does not potentiate receptor activity, perhaps because FKBP12 is not recruited to the receptor complex through an association with Hsp90. To test this possibility, we generated a chimeric protein in which FKBP12 was situated in frame with FK2 and TPR domains of FKBP52, but the chimera failed to potentiate receptor activity in yeast assays (results not shown). FKBP12 shares only 50% amino acid identity with FKBP52-FK1, so there likely are distinct amino acids in FKBP52-FK1 that participate in productive interactions with the receptor.

How does FK1 interaction with the LBD enhance receptor sensitivity to hormone? FKBP52 is known to increase the hormone binding affinity of GR (5, 25) and PR (31), and in Fig. 5C we demonstrate a similar FKBP52-mediated increase in AR hormone binding affinity. There is a fivefold increase in AR affinity for DHT in the presence of FKBP52 compared to FKBP51. Furthermore, the gain-of-function mutant FKBP51-L119P stimulates a two- to threefold increase in DHT binding

affinity compared to wild-type FKBP51; this increase in hormone binding affinity corresponds well with FKBP51-L119P-mediated potentiation of reporter gene expression in AR transactivation assays (Fig. 5B). Since PPIase is not critical for receptor potentiation (Fig. 1), proline isomerization of the receptor LBD is unlikely to account for an increase in hormone binding affinity. As an alternative, perhaps FK1 interaction stabilizes a dynamic LBD conformational state that otherwise is transiently favorable for hormone binding. Unfortunately, little is precisely known about the LBD conformational state(s) of steroid receptors prior to hormone binding. Another possibility we have considered entails alternative orientations by which the LBD might interact with Hsp90. Currently, there is no direct evidence that Hsp90 binds to any particular client in more than one manner, but such a possibility would not be surprising if one considers the vast array of structurally distinct client proteins—steroid receptors, serine/threonine kinases, tyrosine kinases, etc.—that are bound by Hsp90. Given the diversity of structures recognized by Hsp90, we propose that any single client, e.g., the androgen receptor, might be bound by Hsp90 in either of two, or perhaps more, orientations. If Hsp90-associated FKBP52 forms a secondary contact with the receptor LBD, this contact may select an orientation that is more favorable for hormone binding.

Implications. If the FK1 domain of FKBP52 directly contacts the receptor LBD, we anticipate that the LBD site of interaction would be unique and specific to receptors responsive to FKBP52. We are currently pursuing directed genetic approaches with the AR LBD to help with identification of this putative interaction site. One would predict that receptor mutations in or near this FK1 interaction site could occlude FK1 interaction and potentiation, thus generating a receptor that is constitutively nonresponsive to FKBP52. Alternatively, receptor mutation could favor an LBD conformation or orientation vis-à-vis Hsp90 that mimics FKBP52-induced potentiation and thus produces a receptor that constitutively responds to hormone in a potentiated manner. Our identification of an FKBP51 gain-of-function point mutant underscores the opportunity for spontaneous FKBP mutation to influence hormonal responsiveness of tissues. For example, a single base change generating an L119P mutation of FKBP51, whose expression is highly induced by androgens, progestins, or glucocorticoids (reviewed in reference 28), could produce positive feedback that renders tissues hyperresponsive to hormone. Likewise, an inactivating mutation of FKBP52 could constrain tissue responsiveness to a limiting amount of hormone.

In summary, here we have shown that a single amino acid residue at position 119 within the PPIase loop plays a significant role in determining the functional consequence of FKBP5 in steroid receptor complexes. Since the PPIase loop is often involved in protein interactions by FKBP family members, proline 119 in FKBP52 appears to specify a contact site that is functionally critical for steroid receptor interaction and potentiation. FKBP51 fails to potentiate receptor activity largely due to the presence of leucine at position 119. The identification of this critical residue is an important step toward understanding the mechanism of FKBP52-mediated potentiation of steroid signaling.

ACKNOWLEDGMENTS

This work was supported by NIH grant R01 DK48218 (D.F.S.), NIH grant F32 DK068983 (M.B.C.), funds from the Mayo Foundation (D.F.S.), and DFG SFB594 (J.B.).

We thank Natasha Kralli for yeast strains and advice.

REFERENCES

- Barent, R. L., S. C. Nair, D. C. Carr, Y. Ruan, R. A. Rimerman, J. Fulton, Y. Zhang, and D. F. Smith. 1998. Analysis of FKBP51/FKBP52 chimeras and mutants for Hsp90 binding and association with progesterone receptor complexes. *Mol. Endocrinol.* **12**:342–354.
- Chambraud, B., H. Belabes, V. Fontaine-Lenoir, A. Fellous, and E. E. Baulieu. 2007. The immunophilin FKBP52 specifically binds to tubulin and prevents microtubule formation. *FASEB J.* **21**:2787–2797.
- Chen, S., and D. F. Smith. 1998. Hop as an adaptor in the heat shock protein 70 (Hsp70) and Hsp90 chaperone machinery. *J. Biol. Chem.* **273**:35194–35200.
- Cheung-Flynn, J., V. Prapapanich, M. B. Cox, D. L. Riggs, C. Suarez-Quian, and D. F. Smith. 2005. Physiological role for the cochaperone FKBP52 in androgen receptor signaling. *Mol. Endocrinol.* **19**:1654–1666.
- Davies, T. H., Y. M. Ning, and E. R. Sanchez. 2005. Differential control of glucocorticoid receptor hormone-binding function by tetratricopeptide repeat (TPR) proteins and the immunosuppressive ligand FK506. *Biochemistry* **44**:2030–2038.
- Davies, T. H., Y. M. Ning, and E. R. Sanchez. 2002. A new first step in activation of steroid receptors: hormone-induced switching of FKBP51 and FKBP52 immunophilins. *J. Biol. Chem.* **277**:4597–4600.
- Deeb, A., C. Mason, Y. S. Lee, and I. A. Hughes. 2005. Correlation between genotype, phenotype and sex of rearing in 111 patients with partial androgen insensitivity syndrome. *Clin. Endocrinol.* **63**:56–62.
- Denny, W. B., D. L. Valentine, P. D. Reynolds, D. F. Smith, and J. G. Scammell. 2000. Squirrel monkey immunophilin FKBP51 is a potent inhibitor of glucocorticoid receptor binding. *Endocrinology* **141**:4107–4113.
- Dittmar, K. D., K. A. Hutchison, J. K. Owens-Grillo, and W. B. Pratt. 1996. Reconstitution of the steroid receptor · hsp90 heterocomplex assembly system of rabbit reticulocyte lysate. *J. Biol. Chem.* **271**:12833–12839.
- Fanghanel, J., and G. Fischer. 2004. Insights into the catalytic mechanism of peptidyl prolyl cis/trans isomerases. *Front Biosci.* **9**:3453–3478.
- Hernandez, M. P., A. Chadli, and D. O. Toft. 2002. HSP40 binding is the first step in the HSP90 chaperoning pathway for the progesterone receptor. *J. Biol. Chem.* **277**:11873–11881.
- Hochwagen, A., W. H. Tham, G. A. Brar, and A. Amon. 2005. The FK506 binding protein Fpr3 counteracts protein phosphatase 1 to maintain meiotic recombination checkpoint activity. *Cell* **122**:861–873.
- Hong, J., S. T. Kim, S. Tranguch, D. F. Smith, and S. K. Dey. 2007. Deficiency of co-chaperone immunophilin FKBP52 compromises sperm fertilizing capacity. *Reproduction* **133**:395–403.
- Huse, M., Y. G. Chen, J. Massague, and J. Kuriyan. 1999. Crystal structure of the cytoplasmic domain of the type I TGF beta receptor in complex with FKBP12. *Cell* **96**:425–436.
- Hutchison, K. A., L. F. Stancato, J. K. Owens-Grillo, J. L. Johnson, P. Krishna, D. O. Toft, and W. B. Pratt. 1995. The 23-kDa acidic protein in reticulocyte lysate is the weakly bound component of the hsp foldosome that is required for assembly of the glucocorticoid receptor into a functional heterocomplex with hsp90. *J. Biol. Chem.* **270**:18841–18847.
- Johnson, J., T. Beito, C. Krco, and D. O. Toft. 1994. Characterization of a novel 23-kilodalton protein of inactive progesterone receptor complexes. *Mol. Cell. Biol.* **14**:1956–1963.
- Kosano, H., B. Stensgard, M. C. Charlesworth, N. McMahon, and D. O. Toft. 1998. The assembly of progesterone receptor-hsp90 complexes using purified proteins. *J. Biol. Chem.* **273**:32973–32979.
- Liu, J., J. D. Farmer, Jr., W. S. Lane, J. Friedman, I. Weissman, and S. L. Schreiber. 1991. Calcineurin is a common target of cyclophilin-cyclosporin A and FKBP-FK506 complexes. *Cell* **66**:807–815.
- Mumberg, D., R. Muller, and M. Funk. 1995. Yeast vectors for the controlled expression of heterologous proteins in different genetic backgrounds. *Gene* **156**:119–122.
- Nair, S. C., R. A. Rimerman, E. J. Toran, S. Chen, V. Prapapanich, R. N. Butts, and D. F. Smith. 1997. Molecular cloning of human FKBP51 and comparisons of immunophilin interactions with Hsp90 and progesterone receptor. *Mol. Cell. Biol.* **17**:594–603.
- Pirkki, F., and J. Buchner. 2001. Functional analysis of the Hsp90-associated human peptidyl prolyl cis/trans isomerases FKBP51, FKBP52 and Cyp40. *J. Mol. Biol.* **308**:795–806.
- Pratt, W. B., M. D. Galigniana, J. M. Harrell, and D. B. DeFranco. 2004. Role of hsp90 and the hsp90-binding immunophilins in signalling protein movement. *Cell Signal.* **16**:857–872.
- Pratt, W. B., and D. O. Toft. 2003. Regulation of signaling protein function and trafficking by the hsp90/hsp70-based chaperone machinery. *Exp. Biol. Med.* **228**:111–133.
- Reynolds, P. D., Y. Ruan, D. F. Smith, and J. G. Scammell. 1999. Glucocor-

- ticoid resistance in the squirrel monkey is associated with overexpression of the immunophilin FKBP51. *J. Clin. Endocrinol. Metab.* **84**:663–669.
25. **Riggs, D. L., P. J. Roberts, S. C. Chirillo, J. Cheung-Flynn, V. Prapapanich, T. Ratajczak, R. Gaber, D. Picard, and D. F. Smith.** 2003. The Hsp90-binding peptidylprolyl isomerase FKBP52 potentiates glucocorticoid signaling in vivo. *EMBO J.* **22**:1158–1167.
 26. **Silverstein, A. M., M. D. Galigniana, K. C. Kanelakis, C. Radanyi, J. M. Renoir, and W. B. Pratt.** 1999. Different regions of the immunophilin FKBP52 determine its association with the glucocorticoid receptor, hsp90, and cytoplasmic dynein. *J. Biol. Chem.* **274**:36980–36986.
 27. **Sinars, C. R., J. Cheung-Flynn, R. A. Rimerman, J. G. Scammell, D. F. Smith, and J. Clardy.** 2003. Structure of the large FK506-binding protein FKBP51, an Hsp90-binding protein and a component of steroid receptor complexes. *Proc. Natl. Acad. Sci. USA* **100**:868–873.
 28. **Smith, D. F.** 2004. Tetratricopeptide repeat cochaperones in steroid receptor complexes. *Cell Stress Chap.* **9**:109–121.
 29. **Smith, D. F., B. A. Baggenstoss, T. N. Marion, and R. A. Rimerman.** 1993. Two FKBP-related proteins are associated with progesterone receptor complexes. *J. Biol. Chem.* **268**:18365–18371.
 30. **Smith, D. F., W. P. Sullivan, T. N. Marion, K. Zaitso, B. Madden, D. J. McCormick, and D. O. Toft.** 1993. Identification of a 60-kilodalton stress-related protein, p60, which interacts with hsp90 and hsp70. *Mol. Cell. Biol.* **13**:869–876.
 31. **Tranguch, S., J. Cheung-Flynn, T. Daikoku, V. Prapapanich, M. B. Cox, H. Xie, H. Wang, S. K. Das, D. F. Smith, and S. K. Dey.** 2005. Cochaperone immunophilin FKBP52 is critical to uterine receptivity for embryo implantation. *Proc. Natl. Acad. Sci. USA* **102**:14326–14331.
 32. **Tranguch, S., H. Wang, T. Daikoku, H. Xie, D. F. Smith, and S. K. Dey.** 2007. FKBP52 deficiency-conferred uterine progesterone resistance is genetic background and pregnancy stage specific. *J. Clin. Investig.* **117**:1824–1834.
 33. **Van Duyn, G. D., R. F. Standaert, P. A. Karplus, S. L. Schreiber, and J. Clardy.** 1991. Atomic structure of FKBP-FK506, an immunophilin-immunosuppressant complex. *Science* **252**:839–842.
 34. **Wochnik, G. M., J. Ruegg, G. A. Abel, U. Schmidt, F. Holsboer, and T. Rein.** 2005. FK506-binding proteins 51 and 52 differentially regulate dynein interaction and nuclear translocation of the glucocorticoid receptor in mammalian cells. *J. Biol. Chem.* **280**:4609–4616.
 35. **Wu, B., P. Li, Y. Liu, Z. Lou, Y. Ding, C. Shu, S. Ye, M. Bartlam, B. Shen, and Z. Rao.** 2004. 3D structure of human FK506-binding protein 52: implications for the assembly of the glucocorticoid receptor/Hsp90/immunophilin heterocomplex. *Proc. Natl. Acad. Sci. USA* **101**:8348–8353.
 36. **Xin, H. B., K. Rogers, Y. Qi, T. Kanematsu, and S. Fleischer.** 1999. Three amino acid residues determine selective binding of FK506-binding protein 12.6 to the cardiac ryanodine receptor. *J. Biol. Chem.* **274**:15315–15319.
 37. **Yang, Z., I. M. Wolf, H. Chen, S. Periyasamy, Z. Chen, W. Yong, S. Shi, W. Zhao, J. Xu, A. Srivastava, E. R. Sanchez, and W. Shou.** 2006. FK506-binding protein 52 is essential to uterine reproductive physiology controlled by the progesterone receptor a isoform. *Mol. Endocrinol.* **20**:2682–2694.
 38. **Yong, W., Z. Yang, S. Periyasamy, H. Chen, S. Yucel, W. Li, L. Y. Lin, I. M. Wolf, M. J. Cohn, L. S. Baskin, E. R. Sanchez, and W. Shou.** 2007. Essential role for co-chaperone Fkbp52 but not Fkbp51 in androgen receptor-mediated signaling and physiology. *J. Biol. Chem.* **282**:5026–5036.