

THE REFRACTORY STATE OF THE GENERATOR AND
PROPAGATED POTENTIALS IN A
PACINIAN CORPUSCLE

BY WERNER R. LOEWENSTEIN* AND RAFAEL ALTAMIRANO-ORREGO

(From the Institute of Physiology, University of Chile, Santiago)

(Received for publication, September 9, 1957)

ABSTRACT

A propagated potential produced in the Pacinian corpuscle in response to mechanical stimuli leaves a refractory state of 7 to 10 msec. duration. The refractory state is presumably produced at the first intracorporecular node of Ranvier. The recovery of receptor excitability for producing an all-or-none response to mechanical stimulation follows the same time course as that of the electrically excited axon. Upon progressive reduction of stimulus interval (mechanical), the propagated potential falls progressively to 75 per cent of its resting magnitude and becomes finally blocked within the corpuscle. A non-propagated all-or-none potential, presumably corresponding to activity of the first node, is then detected. The critical firing level for all-or-none potentials increases progressively during the relative refractory period of the all-or-none potential, as the stimulus interval is shortened. Thus generator potentials up to 85 per cent of a propagated potential can be produced in absence of all-or-none activity. Generator potentials show: gradual over-all increase in amplitude and rate of rise as a function of stimulus strength; constant latency; and spontaneous fluctuations in amplitude. A generator potential leaves a refractory state (presumably at the non-myelinated ending) so that the amplitude of a second generator response which falls on its refractory trail is directly related to the time elapsed after the first generator response and inversely to its amplitude. The generator potential develops independently of any refractory state left by a preceding all-or-none potential.

INTRODUCTION

Deformation of mechano-receptive sense organs gives rise to non-propagated generator potentials which in turn eventually set up propagated impulses. Absence of propagated potentials would seem a desirable condition for studying the properties of the generator potential. Generator potentials can be studied in isolation by applying subthreshold stimuli to the sense organ. This may be a satisfactory procedure when the receptor cell is big enough to allow the use of intracellular leads. In this case relatively large transmembrane po-

* Present address: Department of Physiology, Columbia University, College of Physicians and Surgeons, New York.

tentials can be recorded. However, in smaller cells in which generator potentials are led off with extracellular electrodes there is considerable loss of the voltage generated across the receptor membrane. In the case of a capsulated sense organ, such as the Pacinian corpuscle, the loss is particularly great. Thus, generator potentials obtained by subthreshold stimulation of the receptor are generally too small for adequate analysis. Relatively large generator potentials have been obtained in receptors by abolishing the propagated potential with procaine, or lowering of extracellular Na concentration (Katz, 1950; Gray and Sato, 1953; Eyzaguirre and Kuffler, 1955). For experiments described in the present and subsequent paper, it was desirable to record generator potentials in Pacinian corpuscles without resorting to the aid of drugs or environmental ionic changes. Taking advantage of the differences in refractoriness of the generator and propagated events, in the present work, generator potentials unaccompanied by propagated potentials were obtained during the refractory period of the propagated impulse. The minimal height of generator potential for setting up a propagated impulse in the corpuscle was found to increase during the refractory period of the latter. Generator potentials of amplitudes up to 85 per cent of the propagated potential could thus be produced during the refractory state of the propagated response. With so convenient an object for analysis, the properties of the processes of impulse generation during refractoriness were studied.

Preliminary accounts of the experiments have been published (Loewenstein and Altamirano-Orrego, 1957, 1958).

Methods

Pieces of the cat's mesentery, containing preferently one single Pacinian corpuscle and its nerve, were excised and pinned to a glass plate for dissection under epi- or transillumination. The upper serosa was slit open to free the upper side of the corpuscle, leaving enough connective tissue to maintain the corpuscle attached to the lower serosa. A stretch of nerve was dissected and freed up to its point of emergence of the corpuscle. The preparation was then set up on a black lucite plate (*P*) and mounted in a bath made of two lucite blocks (*B*₁ and *B*₂) (Fig. 1). The fringes of the patch of mesentery were stretched by, and pressed between the blocks screwed rigidly together. The corpuscle became thus immobilized. The bath contained a phase of mineral oil and another one of oxygenated Krebs' solution (Krebs and Henseleit, 1932) of following composition: NaCl, 115 mM; KCl, 4.60 mM; CaCl₂, 2.46 mM; MgSO₄, 1.15 mM; NaHCO₃, 24.1 mM; KH₂PO₄, 1.15 mM; glucose, 10 mM. In earlier experiments a Ringer's solution was employed, but it soon became apparent that the corpuscle behaved more stably and could be kept alive longer in a Krebs' solution containing O₂ and glucose. In this way, one could work without difficulties over 8 or more hours with an isolated corpuscle. The Krebs' solution was equilibrated with a mixture of O₂ (95 per cent) and CO₂ (5 per cent) bubbling through the solution in channel *T*₃ at low pressure. The latter provided also the energy for circulating the

fluid through the bath. The passage of the gas mixture through T_3 siphoned fluid from T_1 and lifted it up to the chimney A where it would fall to the main compartment (K) through pipe T_2 . Bursting of gas bubbles ensued in the chimney (A) which provided an effective baffle against disturbances which otherwise would reach the corpuscle's chamber (K). The Krebs' fluid was maintained at constant level as it circulated below the essentially stationary oil in K ; it thus served as a stable "ground" electrode. The solution was completely replaced at frequent intervals during each experiment by means of a syringe adapted to the chimney.

Mechanical stimulation of the corpuscle was provided by deflections of an electrically driven piezoelectric crystal. The principle of the method is similar to the

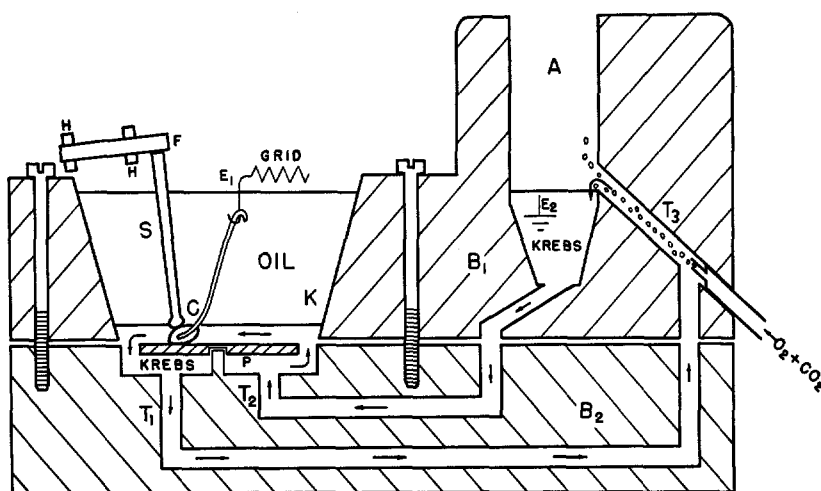

FIG. 1. Diagram of set up. C , corpuscle; S , glass stylus of piezoelectric crystal (F). B_1 , B_2 , bipartite lucite bath with oxygenated Krebs' solution circulating through pipes T_1 , T_2 below the stagnant mineral oil of main compartment K .

one introduced by Gray and Malcolm (1950). Two rectangular pieces (F), each 6 mm. wide, 20 mm. long, were cut out of a Rochelle salt crystal. They were pressed firmly between two pairs of parallel hard rubber strips (H), as shown in Fig. 1, inside a bakelite box. The electric axis was so oriented that a voltage applied across the crystals produced torsion of their free fringe. This movement was transmitted to the corpuscle (C) by means of a hard glass stylus (S). The deflections were followed photoelectrically. At rest, the stylus was positioned in a light beam thrown onto a photocell; one edge of its roughly rectangular shadow, thrown onto the photocell, coincided with the edge of a sharply rectangular illuminated surface on the photocell. The displacement of the stylus could thus be determined directly as a function of potential difference of the photocell. Absolute calibration of the system in linear units was accomplished by direct measurement of stylus displacements with a Leitz filar micrometer under high magnification. Over an ample range of voltage, deflections were a linear function of voltage. Displacements of 0 to 45 μ were available for

finely graded stimulation of the sense organ by application of 0 to 50 volts across the crystal. Unless stated otherwise, the crystal was driven by electrical square pulses of 0.2 msec. duration. When the stylus was in air, a single pulse would cause the system to oscillate for as long as 14 msec. However, with the stylus in its normal position, namely in oil and in contact with the corpuscle, the system became effectively damped so that a single electrical pulse of 0.2 msec. caused, after a latency of 0.2 msec., a single displacement of a total duration of 1 msec. (Fig. 2). Frequencies up to *ca.* 1000/sec. were followed with fidelity by the stimulator device. Frequencies from 1000 to 3500/sec. were still followed but "relaxation" was no longer complete.

The afferent activity of the receptor was lead off between a platinum electrode (E_1 , Fig. 1) and the Krebs-oil interface which served as movable ground electrode.

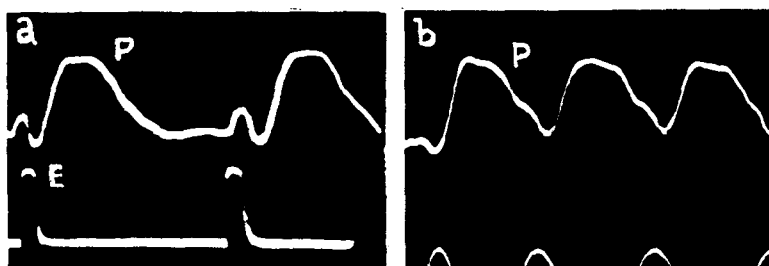

FIG. 2. Samples of photoelectric records of displacements of the stimulating stylus. Rectangular electric pulses (E) of 0.2 msec. duration are applied to the piezoelectric crystal at intervals of *a*, 2 msec. and *b*, 1 msec. The resulting deflections of the stylus are followed photoelectrically (P). The "artefact," intentionally increased in record *a*, has been reduced in *b*. Calibration, 1000 cycles per sec.

For recording of generator and propagated potentials of the corpuscle, the interface was made to coincide with the nerve's emergence from the corpuscle. When records of the propagated events of the axon were desired, the interface was raised to contact a more central portion of the nerve; the peripheral part of the nerve thus submerged in the Krebs' fluid acted as a shunt. The electric activity was fed through a condenser-coupled amplifier of either 100 or 700 msec. time constant into a double beam oscilloscope.

The experiments were done at room temperature, ranging between 19 and 26°C.

RESULTS

Refractoriness of the All-or-Nothing Potential

When two mechanical stimuli of threshold strength are successively delivered to the corpuscle, at an interval longer than 10 msec., each stimulus causes the receptor to respond with a potential which propagates centripetally along its axon. The first propagated response leaves a refractory state behind, so that the threshold for setting up a second propagated potential is raised (Gray and Malcolm, 1950; Álvarez-Buylla and de Arellano, 1953) when the interval

between stimuli is shortened from 7 to 10 to 1.8 to 3 msec. (relative refractory period) (Fig. 3). With further reduction of interval beyond 1.8 to 3 msec., a second propagated potential can no longer be produced at any strength (absolute refractory period). In the wake of the relative refractory period, before the threshold value of the undisturbed corpuscle is reached, there is, in

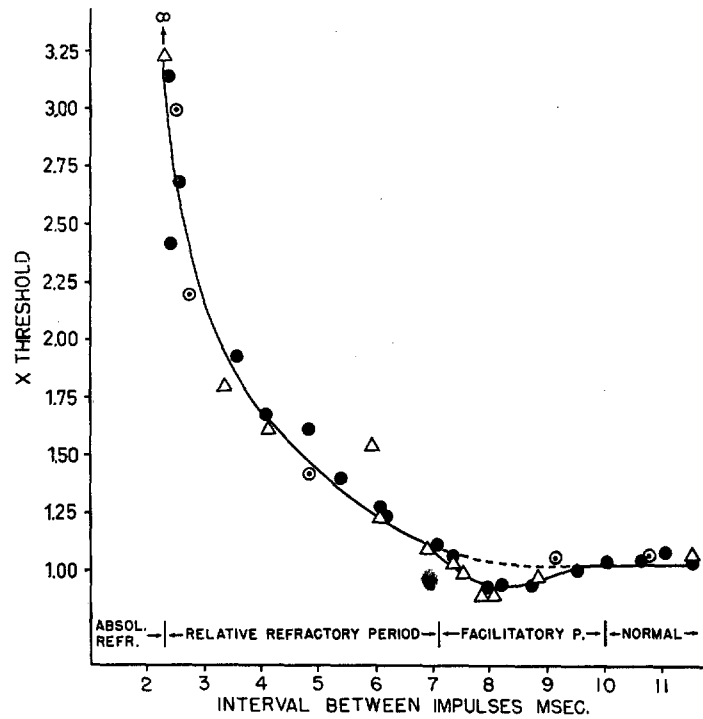

FIG. 3. Recovery of excitability of the receptor and of its axon for setting up a propagated impulse after a preceding propagated impulse. A suprathreshold conditioning stimulus is followed at varying delay by a test stimulus. The minimal strength of test stimulus is expressed in multiples of the normal threshold at rest. Δ and \bullet , mechanical stimulation of the corpuscle. \circ , electrical stimulation of the axon.

most cases, a phase of increased excitability (facilitatory period). The facilitatory period is only found following a propagated potential, and never after a subthreshold stimulus. In a few experiments, excitability curves obtained by mechanical stimulation of the corpuscle during refractoriness, were compared with those gained by electrical stimulation with two successive shocks applied at varying intervals to the axon at some distance from the corpuscle. The resulting excitability curves were practically equal (Fig. 3). It would appear, therefore, that the changes in excitability of the propagated event, occurring

during the relative refractory period, are determined by general properties of the axon rather than by special qualities of the receptor ending. We are not certain whether this also holds true for the facilitatory period.

During the relative refractory period left behind by an all-or-nothing potential, the amplitude of a second all-or-nothing potential declines, as the stimulus interval is made shorter. Fig. 4 illustrates for a typical example the reduction of the all-or-nothing potential in response to the second of a pair of mechanical stimuli. The active recording lead was placed near the point where the axon emerges out of the corpuscle; the central portion of the axon was

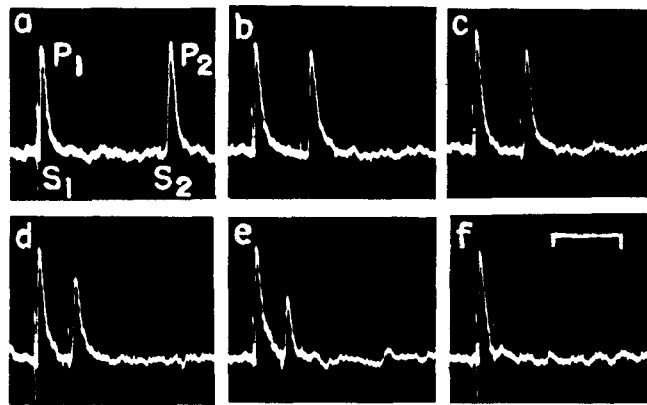

FIG. 4. Changes in amplitude of the all-or-none potential during the relative refractory period. Two mechanical stimuli (S_1 , S_2) are applied in succession to the corpuscle. Stimulus interval decreases from *a* to *f*. S_1 , suprathreshold; S_2 , just threshold for each delay. S_2 falls during *f*, absolute refractory period; *b* to *f*, relative refractory period and *a*, end of relative refractory period. Time, 10 msec.

crushed. Under these conditions the all-or-nothing activity corresponds to the first or second intracorpuseular node of Ranvier. One or two nodes do regularly occur within mesenteric corpuscles (Quilliam and Sato, 1955). The second potential (P_2) is then found to decrease progressively to 55 to 40 per cent of its original resting magnitude, as the interval between the two responses is reduced towards the absolute refractory period, and then falls abruptly to naught. Notwithstanding its reduction in size during the relative refractory period, P_2 behaves in an all-or-nothing manner with respect to a range of mechanical stimuli at any given interval (Fig. 5). An action potential reduced to 55 to 40 per cent of its resting value is very likely below the threshold for saltatory transmission during the early stages of the relative refractory period. It would seem, therefore, that, as the interval approaches the refractory period, the all-or-nothing activity recorded under the stated conditions, corresponds to

the first intracorpuseular node of Ranvier (see subsequent paper). Again, the diminution in amplitude of the all-or-none potential appears to be a general characteristic of the refractory axon rather than a particularity of the receptor: the decrement of P_2 follows practically the same course whether obtained by mechanical stimulation of the corpuscle or by electrical stimulation of distant portions of its axon, as recorded in the latter instance with leads placed at *ca.* 3 mm. from stimulating cathode (Fig. 6). The reduction of P_2 is comparable in magnitude and course to that of the action current of a refractory node of Ranvier of frog nerves (Tasaki, 1953). In a few experiments

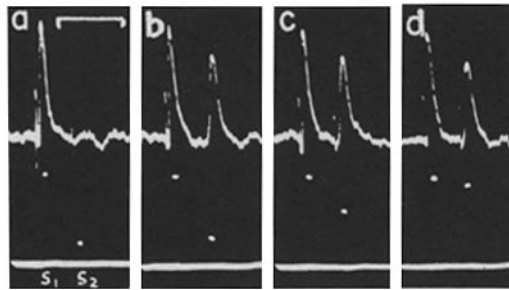

FIG. 5. All-or-none behaviour of the unrecovered explosive propagated potential. Two successive mechanical stimuli (S_1 , S_2), are applied at constant interval. S_1 of constant suprathreshold strength. S_2 increases from subthreshold (*a*) to 3.2 times threshold value (*d*). *b*, S_2 at threshold. Note that in spite of diminished responsiveness during relative refractory period, the second propagated potential is all-or-none with respect to stimulus strength at a given stimulus interval. Height of dots above lower beam indicates relative values of stimuli. Time: 10 msec.

the corpuscle was stimulated mechanically and the recording electrodes were placed on the axon at a distance of more than 15 mm. from the corpuscle. Quilliam and Sato (1955) give 285μ as average internodal distance for the afferent nerve fibre of mesenteric Pacinian corpuscles. Consequently the impulse must have travelled over more than 50 nodes. Even under these circumstances the propagated potential was found to decrement to 75 per cent of its normal resting value during the relative refractory period, before it abruptly vanished when the absolute refractory period was reached. The reduction of the propagated action potential during refractoriness in crustacean (Hodgkin, 1939) and mammalian nerve fibres (Gasser and Grundfest, 1936) is of the same order of magnitude.

The interval between propagated potentials was used for measurements of time in the present paragraphs. In view of the variations in latency of the propagated event in response to threshold stimuli, it seemed a more satisfactory parameter than the interval between stimuli (*c.f.* Rosenblueth, Alanis,

and Mandoki, 1949). The time values in the subsequent paragraphs are, however, conveniently expressed by the stimulus interval. The latter is always identical with the interval between the corresponding generator responses.

Refractoriness of the Generator Potential

When a mechanical stimulus is applied during the relative refractory period left behind by a preceding propagated response, it may fail to produce a

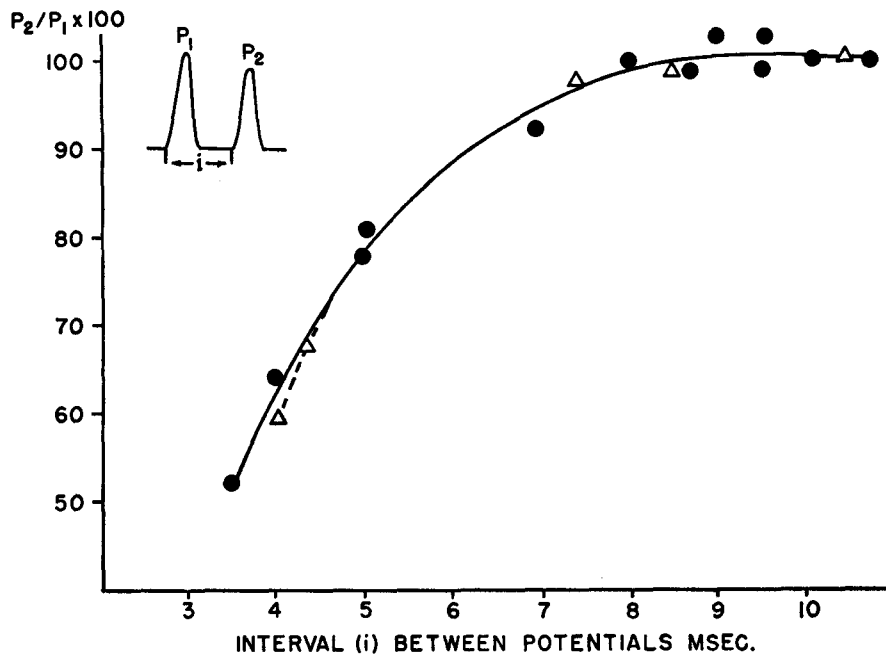

FIG. 6. Recovery of all-or-nothing responsiveness of the receptor and of its axon. Two suprathreshold stimuli are successively applied causing all-or-nothing responses P_1 and P_2 . Relative height of P_2 is plotted against interval between potentials. ●, values from mechanical stimulation of corpuscle; Δ, from electrical stimulation of its axon.

propagated potential and succeed only in setting up a local event. By appropriate choice of stimulus strength and by shortening progressively the stimulus interval, a notch appears when the potential is recorded at the point of axon emergence from the corpuscle (Fig. 7). This notch becomes deeper as the stimulus interval becomes reduced, separating clearly two constituents of the potential. The one which appears last (P) is present whenever a propagated potential can be detected on the axon far away from the corpuscle (Fig. 7 a , a') and vanishes when the propagated potential can no longer be detected with distant leads (b , b'). P may, therefore, be regarded as the intracorporeal

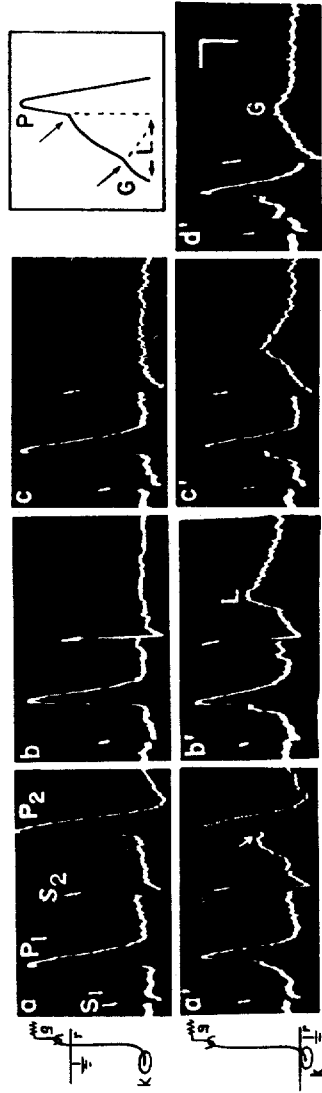

FIG. 7. Separation of local and propagated events during refractoriness. Two successive suprathreshold stimuli are applied to the corpuscle. The first (S_1) produces a propagated response (P_1); the second (S_2) of 2.3 times threshold strength produces either both a local (L) and a propagated response (P_2) (a') or, as the stimulus interval becomes shorter, only a local response (b' to d'). Delay between stimuli is reduced from left to right. a' , b' , c' , d' , recording earth lead at emergence of axon from corpuscle, for recording of local potentials. a , b , c , series done with same stimulus parameters as respectively a' , b' , c' , but with ground lead at some distance from corpuscle for recording exclusively of propagated events. Horizontal bar subtends 1 msec.; vertical bar, 50 μV .

counterpart of the all-or-nothing potential which propagates along the axon, with all its properties described in the preceding section. With further reduction of stimulus interval, P finally dies away. Then, a non-propagated potential (L) is left as the only response to mechanical stimulation (c, c'). This local potential reveals a non-propagated all-or-none- and a graded component. When low stimulus intensities are employed, L is mainly composed of the all-or-none

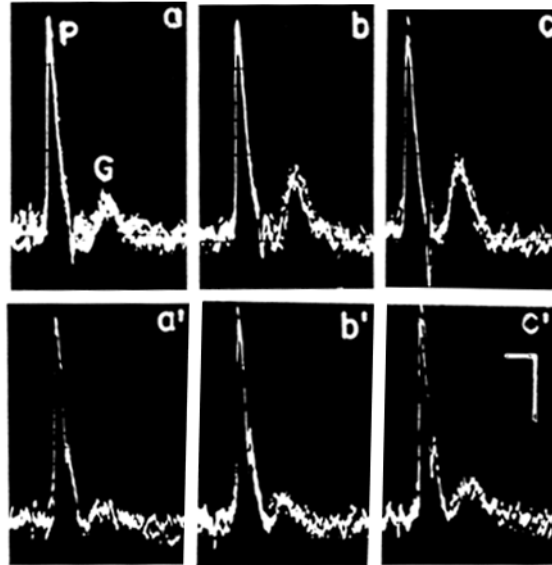

FIG. 8. Effect of stimulus strength and interval on generator potential. Of a pair of successive mechanical stimuli, the first is held at constant suprathreshold strength producing a propagated impulse (P). The second (S_2), falling within the refractory period of P produces a generator potential (G). Two or more successive oscilloscope sweeps have been superimposed. S_2 increases from a to b . Series a, b, c , obtained with stimulus delay of 2 msec. Series a', b', c' , obtained with same stimulus strengths as respectively a, b, c , but delay reduced to 1.5 msec. Calibration: horizontal, 1.5 msec.; vertical, $50 \mu\text{V}$.

component. Its all-or-nothing behaviour can then be shown over a certain range of stimulus strength. It presumably corresponds to activity of the first intracorpuseular node of Ranvier which becomes blocked at the second still refractory node (see subsequent paper). The non-propagated all-or-nothing potential will be referred to in this and subsequent papers as the *abortive T spike*. Further reduction in stimulus interval finally abolishes the all-or-none component, and leaves the graded constituent (G) alone (Fig. 7 d'). The three constituents which are revealed by critical block happening during refractoriness may be compared with the phases recently described by Diamond, Gray, and Sato (1956) by anodal polarization of the corpuscle. Without prejudging

the nature of events, attention should be called also to the striking similarity between the behaviour of the refractory Pacinian corpuscle and that of refractory end-plates (Kuffler, 1942) and motoneurons (Frank and Fourtes, 1955; Coombs, Eccles, and Fatt, 1955 *b*; Frank, K., personal communication).

To analyse the properties of component *G*, we studied it in isolation by rendering the axon refractory to all-or-none activity by a preceding propagated

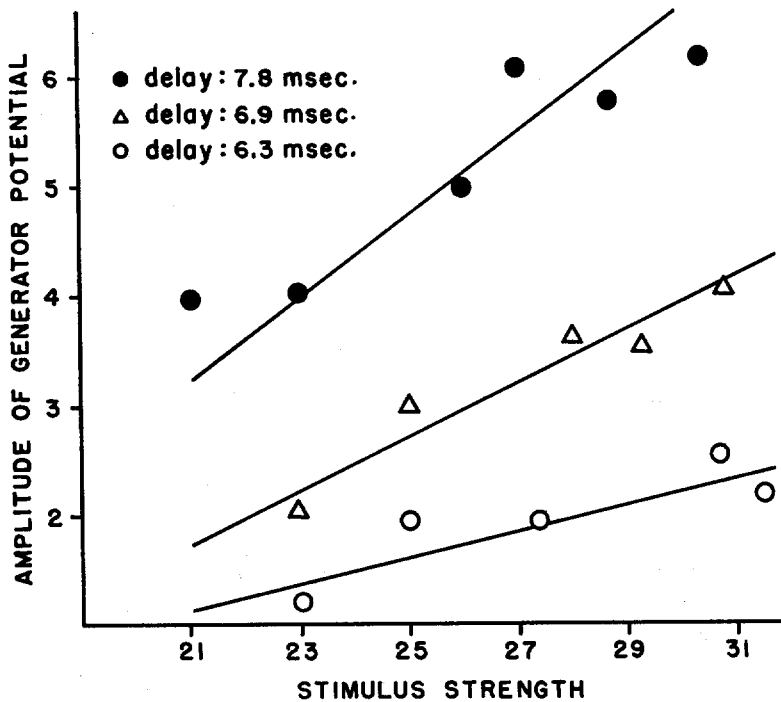

FIG. 9. Generator potential as a function of stimulus strength. The generator potential is produced during refractoriness for the propagated potential by the second of a pair of mechanical stimuli as in preceding figure. Its amplitude obtained at three different stimulus intervals is plotted against stimulus strength.

impulse. Within certain limits of stimulus strength, the graded component is approximately a linear function of stimulus intensity (Figs. 8 and 9). At high ranges of strength, the potential usually attains a ceiling, even if the stimulus magnitude continues to be augmented. However, since we have no method to estimate quantitatively the actual stimulus which deforms the receptor ending, and rely instead on measurement of linear deformation of the corpuscle's capsule, we are unable to decide whether the flattening of the potential curve is a neural effect or due to physical properties of the corpuscle. Besides the increase in size, there is an increased rate of rise of the potential when the stimulus strength is augmented within certain limits. Unlike the propagated poten-

tial, which presents fluctuations and an over-all shortening in latency when the stimulus is increased near threshold, the latency of the graded component is unaffected by changes in stimulus strength. In line with the terminology introduced for photoreceptors by Granit (1947), and now extensively in use for other electrogenic structures, the component will be referred to as generator potential. It would appear that, in general, the term generator potential is well defined by the above qualities, namely gradation of size and rate of rise as a function of stimulus strength, and constancy of latent period. For these and some of the other properties described below, the generator potential here studied, is presumably equivalent to the local response in corpuscles produced by subthreshold stimulation (Álvarez-Buylla and de Arellano, 1953; Gray and Sato, 1953), and to the *receptor potential* obtained by abolishing the propagated potential with procaine or low Na concentrations of the extracellular fluid (Gray and Sato, 1953).

Time Factor of Refractoriness.—Although of a different time course and, because of its graded character, of different nature than the refractoriness of the propagated event, the generator potential also leaves a refractory condition. The degree of refractoriness is determined by two factors, namely, the time elapsed after the occurrence of the generator event and the amplitude of the same. The former can be shown by letting a generator potential follow after a propagated response at varying intervals. Progressive reduction in stimulus interval causes a progressive decrease in amplitude of the generator potential (Figs. 8 and 9). Conversely, in order to produce a generator potential of a given amplitude, the stimulus strength has to be increased as the interval becomes shorter. A similar effect has been shown in the anesthetized corpuscle (Gray and Sato, 1953). For the purpose of showing more directly that the time factor of refractoriness depends on the generator event and not on the propagated potential, experiments were done in which the generator potential under study was made to follow another generator potential. Except for a few exceptional cases, the maximal amplitude of the generator potential which could be detected with external leads in response to subthreshold mechanical stimulation, is too small for adequate analysis. But, if the generator potential is produced by a strong mechanical stimulus, falling early during the refractory period left behind by a preceding propagated event, it is found to reach potentials as high as 85 per cent of the amplitude of a normal propagated potential. Thus uncomplicated by the response of all-or-none events, good material for analysis is available. By delivering three successive mechanical stimuli of suitable strength and sequence to the corpuscle, one can produce patterns, as shown in Fig. 10 *b*, in which two generator potentials (G_2 , G_3) follow a propagated event (P_1). Progressive reduction of interval between the two generator responses is then found to be accompanied by a progressive reduction in size of

G_3 . Unlike the behaviour of the refractory all-or-none potential which after a progressive decrement to a minimum of 40 per cent of its normal amplitude falls abruptly to zero, the generator potential seems to decrease progressively towards zero as the interval is progressively shortened.

Size Factor of Refractoriness.—A variation of the foregoing experiment, illustrated in Fig. 10, reveals the size of the generator event, as the other factor of refractoriness. Of a constant sequence of three mechanical stimuli, the first (S_1) and third (S_3) are held at constant strength, while the second (S_2) is increased by steps (Fig. 10 *a* to *d*). In *a*, with the generator potential (G_2) in response to S_2 at its lowest, the third stimulus (S_3) creates a generator response

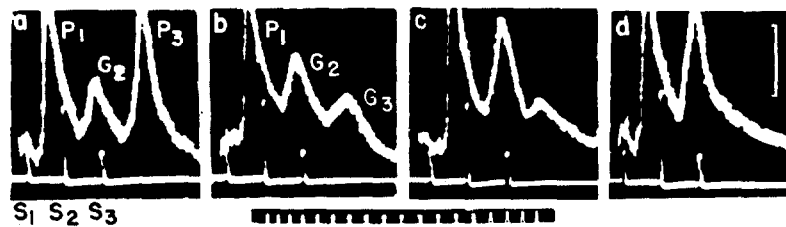

FIG. 10. Size of generator potential determined by the magnitude of a preceding generator potential. Three successive mechanical stimuli S_1 , S_2 , S_3 , are delivered to the corpuscle producing respectively propagated potentials P_1 and generator potentials G_2 , G_3 . Stimulus strengths of S_1 and S_3 are constant. S_2 increases from *a* to *d* producing an increasing G_2 . Note that with G_2 at its lowest (*a*) the third response is a propagated potential P_3 . Thereafter the third response becomes a progressively reduced generator potential (*b* to *d*). Calibration: 1 msec.; 25 μ V.

(G_3) of sufficient height to fire a propagated potential (P_3). A small increase in G_2 , determines a reduction in G_3 which then fails to reach firing level (*b*). With augmentation of G_2 , G_3 becomes still further reduced (Fig. 10 *c* to *d*). This confirms Gray and Sato's (1953) finding in the anesthetized corpuscle. To prevent G_3 from reaching firing level, and, hence, to be able to examine G_3 in terms of a wide range of G_2 , the intervals between stimuli had to be reduced. G_2 became then partially concealed by the first propagated potential, and could no longer be measured. G_3 was plotted therefore against the strength of the second stimulus (S_2), which, as shown before, is in turn a function of G_2 (Fig. 11).

The above experiments show that the magnitude of a generator potential, falling on the refractory trail of a preceding one, is inversely related to the latter's size. If the conditioning generator potential is a maximal response, a subsequent generator event may no longer be detected with external leads over 1 to 2 msec. at any stimulus strength. This condition has then the appearance of an absolute refractory period like that of the propagated all-or-nothing event.

It may be thought that the size and time factors of refractoriness are not

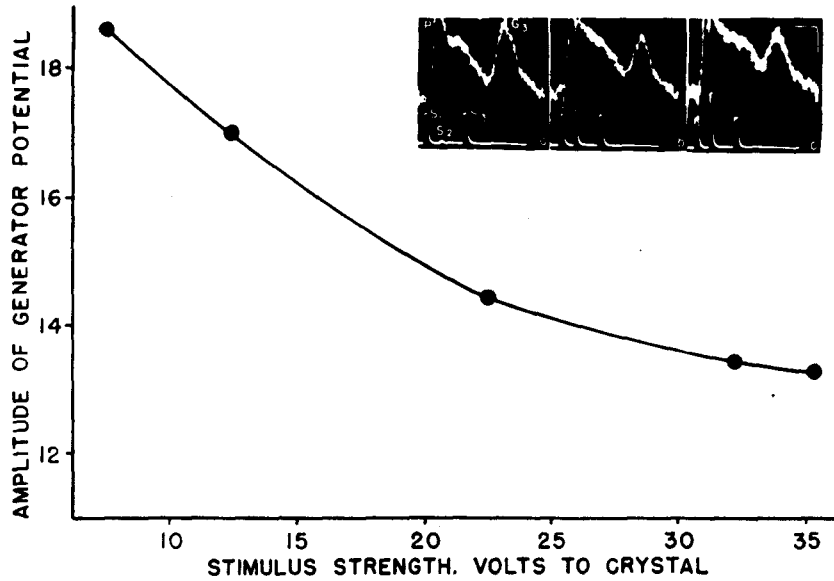

FIG. 11. Generator potential as a function of strength of a preceding stimulus during refractoriness. Three mechanical stimuli S_1 , S_2 , S_3 , are applied producing respectively propagated potential P , and generator potentials G_2 and G_3 (as in Fig. 10). Stimulus strength of S_1 and S_3 constant. The amplitude of G_3 is plotted against the varying strength of S_2 . Calibration of *inset*: 1 msec. $25 \mu\text{V}$.

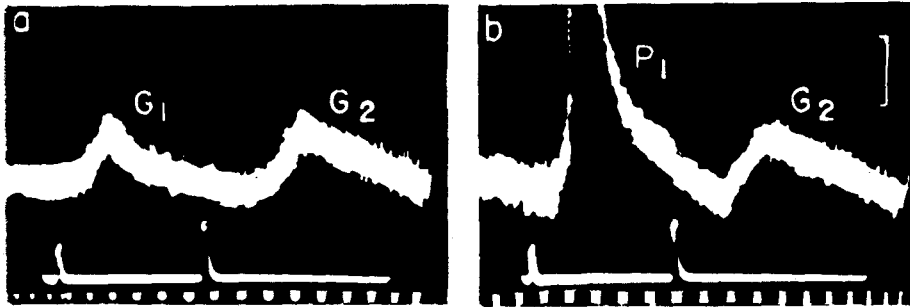

FIG. 12. Independence of refractoriness between generator and propagated potentials. Pairs of mechanical stimuli are applied to the corpuscle. The first stimulus is critically at threshold producing either *a*, a generator potential (G_1) or *b*, a propagated potential (P_1). The second stimulus follows the first at a constant delay of 6 msec. Note that the resulting generator response (G_2) is of same amplitude whether the preceding event is a generator or a several times greater propagated potential. With a generator potential of equivalent amplitude to P_1 , G_2 would have become erased. Calibration, 1 msec. between dots; $25 \mu\text{V}$.

truly of neural origin but determined by mechanical properties of the corpuscle. If the corpuscle's capsular enclosure were to behave so that on recoiling to rest position it lags with a certain delay behind the off-deflection of the stimulating stylus, a condition resembling a refractory state could be produced. However, in the following paper (Loewenstein, 1958) experiments will be described in which sequences of alternating propagated and generator potentials are produced by stimulating the corpuscle repetitively with equal mechanical stimuli at intervals of say $\frac{1}{2}$ relative refractory period. This would be improbable were only mechanical factors responsible for refractoriness. Moreover, the time factor as well as the size factor of the generator potential's

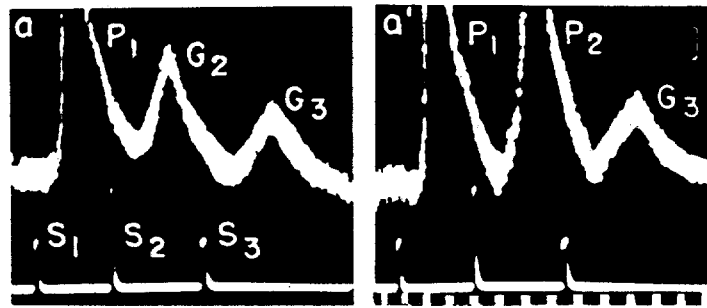

FIG. 13. Refractoriness of generator potential unrelated to refractoriness of the propagated all-or-none event. Second stimulus S_2 is applied during the refractory period left behind by previous propagated potential P_1 . S_2 is held at constant strength in each series satisfying critically threshold conditions, thus producing a generator potential (G_2) or a propagated potential (P_2). Note that G_3 stays unaltered whatever the nature of the preceding response may be, although P_2 is *ca.* 3 times greater than S_2 . Calibration: 1 msec; 25 μ V.

refractoriness were recently shown in remnants of Pacinian corpuscles in which practically all of its capsular structure was dissected off (Loewenstein and Rathkamp, 1958). If mechanical events were responsible for refractoriness, one would expect the time and size factor to decrease as the capsule is progressively peeled off and finally to vanish upon complete removal of the capsule. On the contrary, no significant changes in the time and size factors were observed after depriving the receptor of its capsule. We may conclude therefore, that the generator potential's refractory state is of neural origin.

Independence of Refractoriness between Generator and Propagated Processes

The refractory state which a propagated potential leaves behind has no influence on the generator event. For example, a pair of constant mechanical stimuli (S_1 , S_2) is delivered to the corpuscle (Fig. 12). S_1 is just critically of threshold strength, so that out of a number of stimulations, some will cause

generator potentials (G_1) while others will produce propagated potentials (P_1). The amplitude of the second generator potential (G_2) remains the same, whether the preceding event is a generator potential, or a several times greater propagated potential. With a generator potential of an amplitude equivalent to P_1 , G_2 of the cited example would have become erased. Similar results were obtained by triple stimulation. This method has the advantage over the former of providing measurable generator potentials in all corpuscles. Furthermore it allows the testing of generator potential refractoriness over a wider range of stimulus strength and interval. In Fig. 13 an example is given. Of three constant mechanical stimuli, S_2 is just critically threshold. Generator response G_3 is practically of the same amplitude whether preceded by a generator event G_2 or by a several times larger propagated potential P_2 . With a generator potential (G_2) of an amplitude equivalent to P_2 , G_3 would have become erased. Normally the generator potentials present small fluctuations. Statistical analysis of the aforementioned results seemed therefore advisable, in case the propagated event exerted a small influence on the succeeding generator potential. Three series of 40 stimulations, like those of Fig. 13, were examined statistically. None showed a significant variation of G_3 .

A hump is often seen at the end of an action current recorded near the nerve ending (Fig. 14). It may be due to persistence of the generator potential at the terminal. This in turn may mean that the generator potential is not erased by the all-or-nothing potential as appears to be the case at the curarized motor end-plate. It may be interpreted as giving a further indication of independence between the sites of origin of generator and propagated events. On the other hand, it might merely mean that the mechano-electric transducer effect outlasts the spike, which would be analogous to the prolonged transmitter action at an anti-esterase-treated end-plate (Eccles, Katz, and Kuffler, 1942; Fatt and Katz, 1951).

Spontaneous Fluctuations of Generator Potential

With single stimuli of constant strength, the generator potentials fluctuate around an average value. The fluctuations in amplitude were usually less than 10 per cent. They increased as the absolute refractory period was approached. The photoelectric method employed was of high enough a resolution to eliminate individual variations in deflections of the stimulator device as causes of the generator fluctuations. It seems likely that the fluctuations are spontaneous phenomena of nervous origin. However, variations of mechanical factors within the corpuscle, which may be directly related to the stimulation of the receptor terminal, such as intracorpuseular pressure changes, cannot be discarded as possible causes of the fluctuations in generator potential.

Firing Height of Generator Potential during Refractoriness

The minimal amplitude of generator potential (firing height) at which firing of propagated potentials occurs is fairly constant. The Pacinian corpuscle

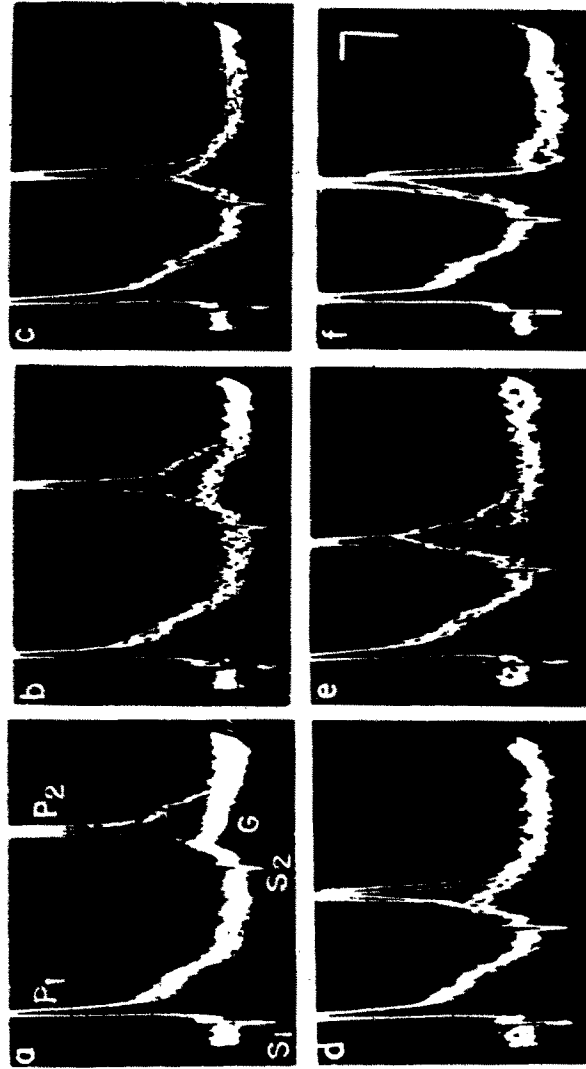

FIG. 14. Changes in firing height during recovery from refractoriness. Two successive mechanical stimuli are delivered to the corpuscle at decreasing delay from *a* to *f*. First stimulus S_1 , of constant suprathreshold strength throughout all series, produces a propagated potential (P_1). Second stimulus (S_2) is increased from *a* to *f* so as to satisfy critically the threshold conditions for each stimulus delay, causing a generator potential (G) or, out of a number of stimuli, a propagated impulse (P_2). Each frame shows the superimposed responses to several successive pairs of stimuli. Calibration of abscissa: 1 msec.; ordinates: 50 μV .

thus behaves like other excitable structures such as crustacean axons (Hodgkin, 1939; Hodgkin, Huxley, and Katz, 1952), frog axons (Tasaki, 1956) motor end-plates (Fatt and Katz, 1951; Nastuk, 1953), cardiac pacemaker fibres (Weidmann, 1951), spinal nerve cells (Coombs, Eccles, and Fatt, 1955 *a*; Araki and Otani, 1955; Frank and Fourtes, 1956), electroplaques (Keynes and Martins-Ferreira, 1953; Altamirano, Coates, and Grundfest, 1954) crustacean stretch receptor nerve cells (Eyzaguirre and Kuffler, 1955). Measurements of the transmembrane potential at the site of origin of the generator

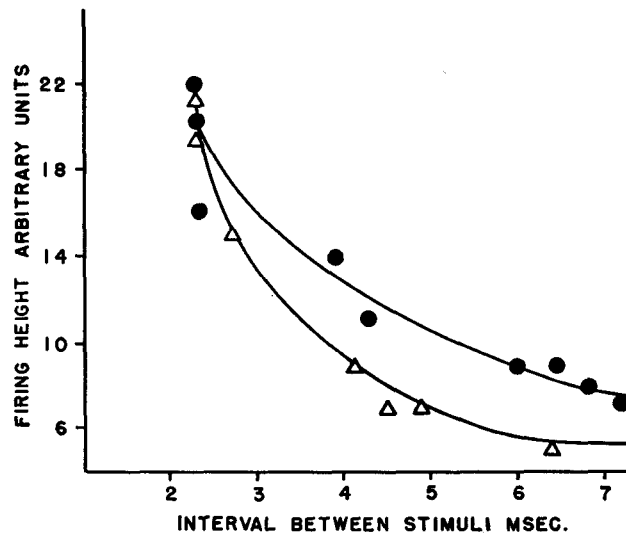

FIG. 15. Firing height as a function of stimulus delay during refractoriness. The firing height, namely the minimal generator potential at which a propagated potential would start off, is plotted against the interval between two successive mechanical stimuli. ● and △, data from two different corpuscles. Fig. 14 gives an example of the procedure used.

events were not done in the present experiments. The generator potentials obtained under the present conditions may, however, be regarded as good index of the absolute changes in membrane potential. The term firing height employed here and in subsequent papers describes therefore an index of depolarization starting from an unknown base of membrane potential. It provides an index of the critical level of transmembrane potential at which firing occurs only as long as the generator potential starts from a constant base of membrane potential. For a given interval between two successive mechanical stimuli, the corpuscle's firing height is fairly constant. By reduction of interval, and superimposing several responses to threshold stimuli on the same oscilloscope sweep, the firing height is shown to rise as the stimulus interval is shortened (Figs. 14 and 15). Near absolute refractoriness the firing height was seen to rise to 85

per cent of the amplitude of a normal propagated potential. Thus, when the absolute refractory period was approached, it was often difficult to distinguish between a generator-, abortive *T*-, or propagated response. The following criteria were then employed for classifying the studied response as a generator potential: its graded increase in size and rate of rise with increasing stimulus strength; its non-propagation, as tested by a pair of leads placed on the axon at some distance from the corpuscle; and its gradual reduction in size following a gradual increase of the preceding stimulus.

The increase in firing height, together with the reduction in amplitude of the refractory generator potential appear to be the determinants of threshold rise during the corpuscle's relative refractory period. By establishing the relation between interval and magnitude of generator potential, on one hand, and that between interval and firing level, on the other, it is possible to predict threshold at any interval. Likewise, the sense organ's behaviour under repetitive stimulation described in the following paper may be derived herefrom.

Discussion of the present results will be combined with that of the subsequent paper.

We take pleasure in thanking Professor B. Katz, University College, London, for reading the manuscript. One of us (W. R. L.) is indebted to Dr. R. Álvarez-Buylla for demonstrating the technique for isolation of Pacinian corpuscles. We are indebted to Dr. Mario Altamirano for discussion, to Mr. A. Toutin-Olliver for continuous technical assistance, and to Mr. G. Prieto for providing the Rochelle salt crystals. The work was aided by a grant from The Rockefeller Foundation.

REFERENCES

- Álvarez-Buylla, R., and de Arellano, J. R., 1953, Local responses in Pacinian corpuscles, *Am. J. Physiol.*, **172**, 237.
- Altamirano, M., Coates, C. W., and Grundfest, H., 1954, Mechanism of direct and neural excitability in electroplaques of electric eel, *J. Gen. Physiol.*, **38**, 319.
- Araki, T., and Otani, T., 1955, Response of single motoneurons to direct stimulation in toad's spinal cord, *J. Neurophysiol.*, **18**, 472.
- Coombs, J. S., Eccles, J. C., and Fatt, P., 1955 *a*, The electrical properties of the motoneurone membrane, *J. Physiol.*, **130**, 291.
- Coombs, J. S., Eccles, J. C., and Fatt, P., 1955 *b*, Excitatory synaptic action in motoneurons, *J. Physiol.*, **130**, 374.
- Diamond, J., Gray, J. A. B., and Sato, M., 1956, The site of initiation of impulses in Pacinian corpuscles, *J. Physiol.*, **133**, 54.
- Eccles, J. C., Katz, B., and Kuffler, S. W., 1942, Effect of eserine on neuromuscular transmission, *J. Neurophysiol.*, **5**, 211.
- Eyzaguirre, C., and Kuffler, S. W., 1955, Processes of excitation in the dendrites and in the soma of single isolated sensory nerve cells of the lobster and crayfish, *J. Gen. Physiol.*, **39**, 87.
- Fatt, P., and Katz, B., 1951, An analysis of the endplate potential recorded with an intracellular electrode, *J. Physiol.*, **115**, 320.

- Frank, K., and Fourtes, M. G. F., 1955, Potentials from the spinal cord with micro-electrodes, *J. Physiol.*, **130**, 625.
- Frank, K., and Fourtes, M. G. F., 1956, Stimulation of spinal motoneurons with intracellular electrodes, *J. Physiol.*, **134**, 451.
- Gasser, H. S., and Grundfest, H., 1936, Action and excitability in mammalian A fibers, *Am. J. Physiol.*, **117**, 113.
- Granit, R., 1947, *Sensory Mechanisms of the Retina*, London, Oxford University Press.
- Gray, J. A. B., and Malcolm, J. L., 1950, The initiation of nerve impulses by mesenteric Pacinian corpuscles, *Proc. Roy. Soc., Series B*, **137**, 96.
- Gray, J. A. B., and Sato, M., 1953, Properties of the receptor potential in Pacinian corpuscles, *J. Physiol.*, **122**, 610.
- Hodgkin, A. L., 1939, The subthreshold potentials in a crustacean nerve fibre, *Proc. Roy. Soc., Series B*, **126**, 87.
- Hodgkin, A. L., Huxley, A. F., and Katz, B., 1952, Measurement of current voltage relations in the membrane of the giant axon of *Loligo*, *J. Physiol.*, **116**, 424.
- Katz, B., 1950, Depolarization of sensory terminals and the initiation of impulses in the muscle spindle, *J. Physiol.*, **111**, 261.
- Keynes, R. D., and Martins-Ferreira, H., 1953, Membrane potentials in the electroplates of the electric eel, *J. Physiol.*, **119**, 315.
- Kuffler, S. W., 1942, Responses during refractory period at myoneural junction in isolated nerve-muscle fibre preparation, *J. Neurophysiol.*, **5**, 199.
- Krebs, H. A., and Henseleit, K., 1932, Untersuchungen über Harnstoffbildung im Tierkörper, *Z. Physiol. Chem. (Hoppe-Seyler's)*, **210**, 33.
- Loewenstein, W. R., 1958, Generator processes of repetitive activity in a Pacinian corpuscle, *J. Gen. Physiol.*, **41**, 825.
- Loewenstein, W. R., and Altamirano-Orrego, R., 1957, Processes of generation and propagation during refractoriness in an isolated Pacinian corpuscle, *Proc. 1st Congress of Asociación Latino Americana de Ciencias Fisiológicas, Punta del Este, Uruguay*, 115.
- Loewenstein, W. R., and Altamirano-Orrego, R., 1958, Generation and propagation of impulses during refractoriness in a Pacinian corpuscle, *Nature*, **181**, 124.
- Loewenstein, W. R., and Rathkamp, R., 1958, Localization of generator structures of electric activity in a Pacinian corpuscle, *Science*, **127**, 341.
- Nastuk, W. L., 1953, The electrical activity of the muscle cell membrane at the neuromuscular junction, *J. Cell and Comp. Physiol.*, **42**, 249.
- Quilliam, T. A., and Sato, M., 1955, The distribution of myelin on nerve fibres from Pacinian corpuscles, *J. Physiol.*, **129**, 167.
- Rosenblueth, A., Alanis, J., and Mandoki, J., 1949, The functional refractory period of axons, *J. Cell. and Comp. Physiol.*, **33**, 405.
- Tasaki, I., 1953, *Nervous Transmission*, Springfield, Illinois, Charles C. Thomas.
- Tasaki, I., 1956, Initiation and abolition of the action potential of a single node of Ranvier, *J. Gen. Physiol.*, **39**, 377.
- Weidmann, S., 1951, Effect of current flow on the membrane potential of cardiac muscle, *J. Physiol.*, **115**, 227.