

THE ECOLOGY OF THE BED-BUG, *CIMEX*
LECTULARIUS L., IN BRITAIN

REPORT ON RESEARCH, 1935-40

BY C. G. JOHNSON, B.Sc., PH.D.

*From the Department of Entomology, London School of Hygiene
and Tropical Medicine*

(With 39 Figures in the Text)

| CONTENTS | | PAGE |
|---|--|------|
| I. An analysis and consideration of some important factors affecting bed-bug populations | | 347 |
| 1. Introduction | | 347 |
| 2. The temperature of the environment | | 349 |
| 3. The development from egg to adult | | 353 |
| A. Foreword | | 353 |
| B. The rate of development | | 353 |
| (a) The incubation period of the egg | | 353 |
| Time of laying | | 353 |
| Constant temperatures and humidities | | 354 |
| Some alternating temperatures | | 355 |
| (b) The periods from feeding to moulting of the nymphs | | 356 |
| (c) The periods from moulting to feeding of the nymphs | | 357 |
| (d) The periods between feeding and oviposition in the adult | | 359 |
| (e) Conclusions and the rate of development of a free-living population | | 360 |
| C. The influence of environment on the proportions of normal eggs which develop and hatch | | 363 |
| (a) Factors affecting the developmental-hatching threshold | | 363 |
| Definitions | | 363 |
| Alternating temperature | | 363 |
| Atmospheric humidity | | 363 |
| (b) The effect of the temperature during embryonic development on the hatching threshold | | 364 |
| (c) Constant temperatures and humidities: above the developmental-hatching threshold | | 366 |
| (d) The effect of temperature and humidity during incubation | | 366 |
| (e) The effect of the temperature at oviposition | | 368 |
| (f) Survival at temperatures below the developmental-hatching threshold | | 368 |
| The effect of age | | 368 |
| The effect of temperature | | 369 |
| The effect of humidity | | 371 |
| The temperature of oviposition | | 372 |
| Results of other workers | | 372 |
| D. The proportions of nymphs which moult after feeding | | 373 |
| (a) The effect of the temperature of incubation | | 373 |
| (b) The effect of the temperature during the prefeeding period | | 373 |
| E. Mortality during development | | 374 |
| 4. The egg production of adults | | 375 |
| A. Egg production from a single blood-meal | | 375 |
| (a) The weight of the unfed female and of the blood-meal | | 375 |
| Bugs fed to repletion | | 375 |
| Partial feeds | | 379 |

| | PAGE |
|---|------|
| (b) The effect of temperature and atmospheric humidity | 379 |
| Temperature | 379 |
| Humidity | 381 |
| (c) The blood of different hosts | 382 |
| B. Egg production in the laboratory with repeated opportunities to feed: when males and females cohabit | 383 |
| (a) The effect of different intervals between meals | 383 |
| (b) The effects of temperature and atmospheric humidity | 385 |
| Conditions of this experiment | 385 |
| C. Egg production and mating | 387 |
| (a) Fertile and infertile eggs | 387 |
| (b) Repeatedly fed, mated females in the absence of males | 388 |
| (c) The sojourn of mated females below the threshold temperature for egg production and the effect on subsequent oviposition | 391 |
| (d) The willingness and opportunity to mate | 392 |
| Mating at low temperatures | 392 |
| Mating at 23° C. (73.4° F.) | 392 |
| D. The effects of inbreeding on egg production and fertility | 395 |
| E. The fertility of females from wild populations | 397 |
| Consideration of the data | 398 |
| 5. The survival of fed and starved adults in the laboratory and in free-living populations and the survival of starved nymphs | 401 |
| A. Foreword | 401 |
| B. Mortality in cultures: adults which mate freely and feed regularly | 402 |
| C. Survival of fasting nymphs and adults | 406 |
| (a) Survival of fasting adults | 406 |
| Virginity and survival | 406 |
| (b) Survival of fasting nymphs | 406 |
| (c) Some maximal times of survival including records of other workers | 413 |
| D. Mortality of adults in free-living populations | 413 |
| E. Lethal temperatures | 418 |
| (a) High temperatures | 418 |
| The egg—Nymphs (first instar)—Adults | 418 |
| (b) Low temperatures | 418 |
| The egg—Nymphs and adults | 418 |
| 6. The composition of wild populations of bed-bugs | 419 |
| 7. Alternative hosts for <i>Cimex lectularius</i> | 421 |
| 8. The behaviour of bed-bugs | 423 |
| A. Foreword | 423 |
| B. Factors associated with the initiation of activity in a population | 424 |
| (a) Methods | 424 |
| (b) Bugs about on walls, floor and ceiling and those caught in traps, in relation to temperature | 426 |
| Host absent | 426 |
| Host present | 427 |
| The threshold for movement | 429 |
| (c) Activity in relation to light | 429 |
| (d) The frequency of movement and of feeding of bugs in a free-living population | 431 |
| C. Orientation to stimuli | 432 |
| II. Deductions on the state of populations throughout the year | 433 |
| Acknowledgements | 452 |
| References | 452 |
| Appendix A. On technique | 454 |
| Appendix B. On future research | 459 |

I. AN ANALYSIS AND CONSIDERATION OF SOME IMPORTANT FACTORS AFFECTING BED-BUG POPULATIONS

1. INTRODUCTION

IN 1934 a committee on the eradication of bed-bugs appointed by the Minister of Health issued its report (*Report on the Bed-bug, 1934*) in which recommendations for research into the biology of *Cimex lectularius* L. were made. The committee was struck by the lack of precise information on certain aspects of the bionomics and habits of the insect and suggested work along the following lines:

The effect of food supply and starvation at different seasons and at different stages of development.

The periods of survival of bed-bugs and their eggs under different conditions.

The extent to which bed-bugs can subsist on the blood of birds, bats, mice, etc., when deprived of human blood.

The position and types of harbourages most favoured by bed-bugs under different conditions.

The distance which bed-bugs will travel, the factors (warmth, smell, etc.) which attract them, and whether they habitually return to the same harbourage.

It might be possible to work on each of these sections separately and with the minimum of reference to each other. Yet the problems they present are interrelated; moreover, as with any other insect pest data are required on populations rather than on individuals, for it is knowledge of the conditions which allow the insect to exist in inconvenient numbers which is fundamental to successful control. The orientation of the present work has, therefore, been towards this wider view of bed-bug biology with an attempt to make a comprehensive picture of the life of this insect in its collective aspect. The work recommended by the committee has thus been pursued; but it has become incorporated into the general picture.

The factors which influence the growth and decline of bed-bug populations are exceedingly numerous and they interact in a complex way. It is necessary to know what these factors are and which are the most important. They may be studied, one by one, under strictly controlled laboratory conditions and some assessment made of the extent to which they may operate or become master factors in nature. Such an analysis is rigid, but in its course ideas and hypotheses of probable events in nature become crystallized; and it is then necessary to test them by more naturalistic experiments in which some factors, though not controlled, are known and measurable. Later, results from laboratory and naturalistic experiments may be correlated with actual occurrences in the field. Such a scheme of work is summarized in Fig. 1.

The order in which these three types of work will be undertaken depends on the inclination of the investigator and on the state of knowledge at the

time; but for a comprehensive view of the insect's 'collective biology' there must be a fusion of all three lines of approach. This is the aim of modern insect ecology, but work has not moved far along this desirable path except in the cases of a few insects. Therefore it is important to the subject of ecology, as well as for specific problems of *Cimex*, that this attitude should be maintained.

The work described in this report has proceeded from laboratory studies towards naturalistic experiments and field work. The laboratory analysis of the various factors is described in Part I, where the more important data are

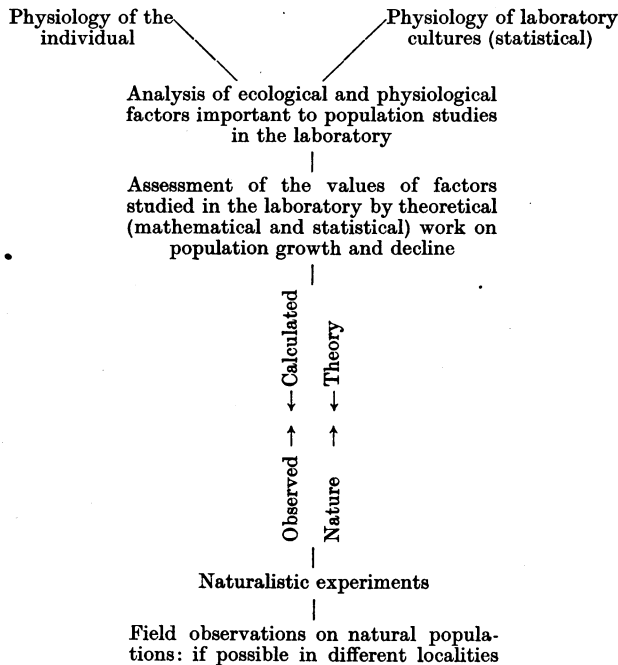

Fig. 1. Scheme for research.

tabulated and may be used for specific questions of detail; results of other workers are incorporated where relevant. I have made no attempt to discuss anatomical or the more intimate physiological aspects of the bed-bug. The report, moreover, is concerned with *C. lectularius* L., and the biology of *C. hemipterus* Fabr., the tropical bed-bug, is not considered.

In Part II an attempt has been made to construct a theoretical plan of bed-bug life; but this should be regarded as no more than a deductive step towards a synthesis of the interacting factors. Its firmness as a foundation for a more complete understanding of bed-bug ecology can be judged only in the light of more naturalistic experiments and more field work. Part II aims to epitomize the ecology of *C. lectularius* as known at present; it is perhaps best read immediately after the section on environmental temperatures. References to Part I may then be made incidentally.

When the complexities of the collective biology of *Cimex* are appreciated it is obvious that clear-cut population theories are improbable. Environmental conditions and the constitution of the insects themselves may vary from place to place. Yet the bed-bug has a comparatively simple life, for it has no known parasites and apparently no important enemies apart from man, whose acts are unpredictable and cataclysmic. The utmost that can be expected at the moment is a very rough estimate of possible events within a population if environmental and constitutional factors are known and if serious interference from man is absent.

The most obviously important factors which affect populations of *Cimex lectularius* may be listed as internal and external factors: both categories are inseparably associated in nature:

| External factors | ←-----→ | Internal factors |
|--|---------|--|
| Temperature | | Development |
| Atmospheric humidity | | Reproduction |
| Radiation | | |
| Structure, colour and smell of the habitat | | Longevity and mortality |
| | | Feeding |
| Man | | Constitution of the population and of its individual members |
| Other hosts | | |
| Location of hosts | | |

Temperature has been fundamental to all the work, and it occupies such an important place that the temperature of the environment is best discussed immediately and in a separate section.

2. THE TEMPERATURE OF THE ENVIRONMENT

The fluctuation of the environmental temperature is probably the most important single factor influencing the state of bed-bug populations in nature. For, in common with all other insects, bed-bugs closely assume the temperature of their surroundings and their rates of reproduction and mortality are affected accordingly.

It was necessary, therefore, to know the environmental temperatures and their fluctuations before suitable experiments could be planned and their results correlated with conditions inside houses. It was soon found that a thorough survey of the temperatures inside British houses throughout the whole year was lacking; this had to be made. Thermographs and thermometers were kept in a variety of rooms in London for 12 consecutive months

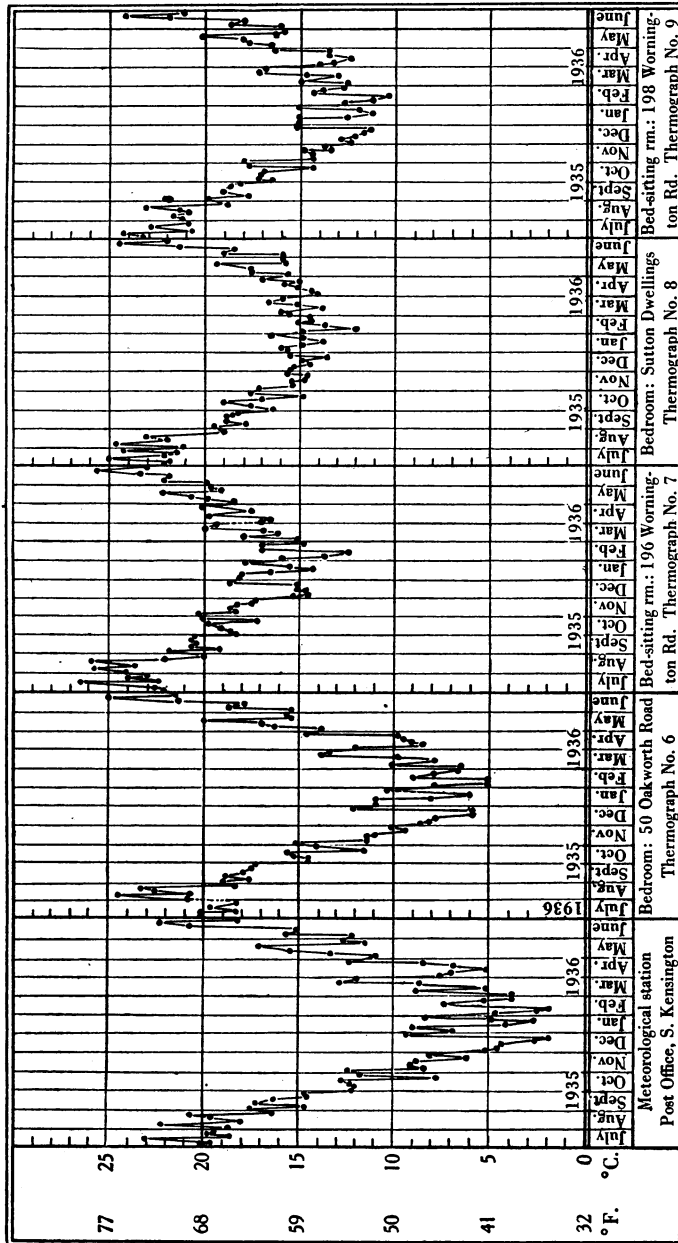

Fig. 2. Temperatures in rooms of various houses in Kensington for 1935-6, expressed as means for 5-day periods.

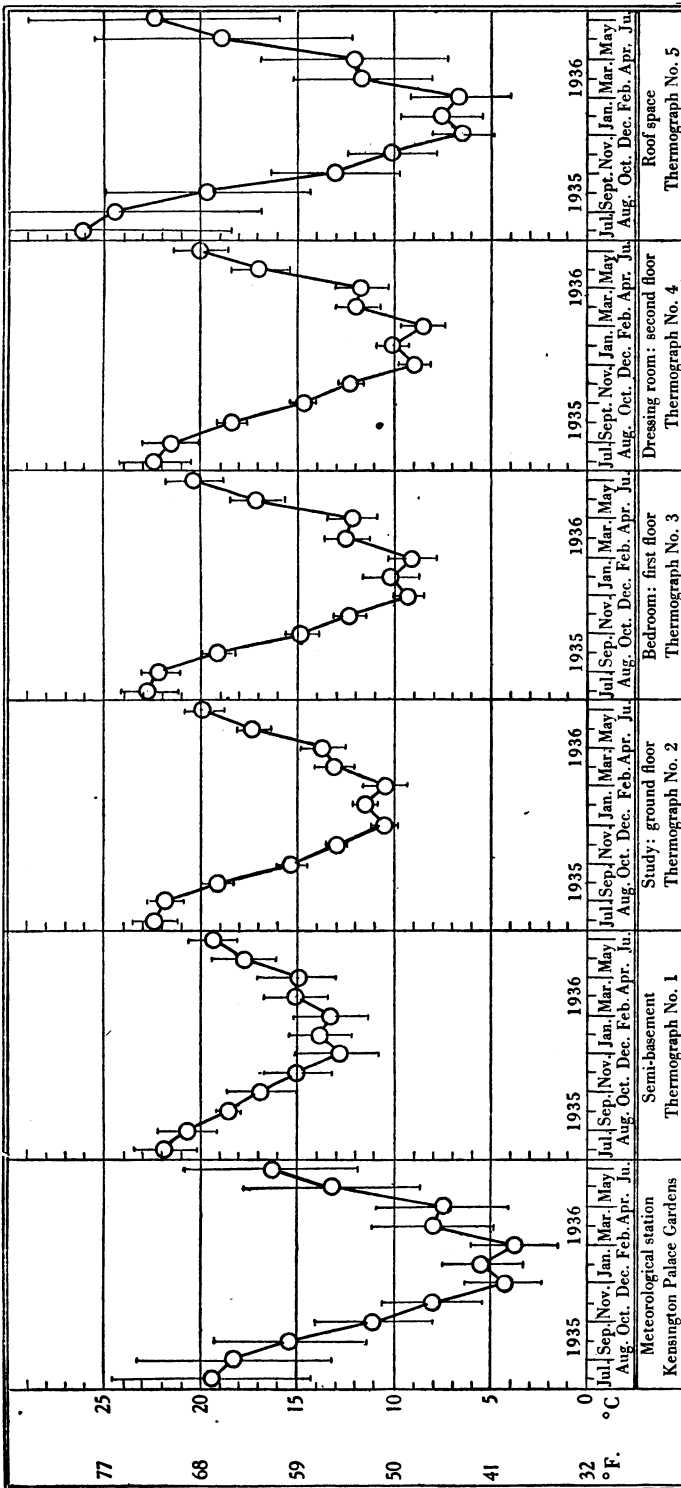
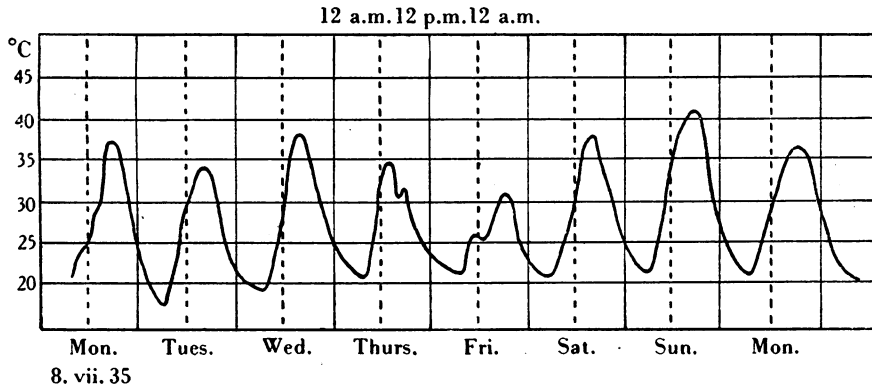

Fig. 3. Mean monthly temperatures and mean minimum and maximum monthly temperatures in the rooms of 54 Palace Gardens Terrace for 1935-6. Circles indicate mean monthly temperatures. Vertical lines through circles indicate mean maximum and mean minimum monthly temperatures.

(1935-6); the procedure and results have been summarized in detail elsewhere (Johnson, 1938). These records are the background for bed-bug biology.

The temperatures in the more concealed places where bugs rest (behind window frames and in bedsteads, etc.) are, no doubt, slightly different from those of the air in the room space as measured by thermographs: these microclimates have, as yet, received little attention, though records which I have made indicate that the differences may not be more than 2° C. between the room space and structures on the walls. Landsberg (1938) has recorded temperatures within the bed itself, but at present these data have no place in bed-bug ecology. Thermograph records, however, provide a good basis for the investigation of microclimatic conditions, and they are also a general guide to the planning and interpretation of laboratory work on the physiology and ecology of the insect. Where resting places are more exposed thermograph records are possibly quite an accurate guide to the temperature around the bugs. Figs. 2-4 summarize some of the results obtained.



8. vii. 35

Fig. 4. Reconstruction of thermograph chart of second week in July 1935 for roof space at 54 Palace Gardens Terrace.

The significance of this survey of house temperatures is realized when we consider that, in the past, experiments on *C. lectularius* have been made either at very high constant temperatures (27-40° C. = 80.6-104.0° F.) (Janisch, 1933, 1935) which are never maintained for more than an hour or two in British houses, or at lower ones of 22-27° C. (71.6-80.6° F.) (Kemper, 1936; Hase, 1917, 1930) corresponding to British summer conditions within rooms. The important range between 23 and 0° C. (73.4 and 32° F.) has been almost entirely neglected; and a glance at the temperature charts (Figs. 2-4) shows that this is almost the whole range in which bed-bugs live in Britain. Experiments have, therefore, been planned to cover this entire range, and our picture is drawn largely within its limits. Throughout the report, it will be necessary to have these temperature charts at hand for the real significance of the discussions to be appreciated.

3. THE DEVELOPMENT FROM EGG TO ADULT

A. Foreword

The speed and success with which bugs attain sexual maturity are very important factors in estimating the reproductive potentialities of the population, since they govern the rate and completeness with which succeeding generations are produced.

Besides the egg, there are five nymphal instars in *Cimex* and the last of these moults into the adult. Each nymph must take a meal of blood before it is able to moult into the next stage; one meal, if above a certain size, will cause a nymph to moult provided the temperature is favourable. (For weights of meals see Jones, 1930; Titschack, 1930; Johnson, 1937.) But several small meals, each insufficient to cause a moult, will prolong an instar (Kemper, 1931). Before the female adult will lay eggs she must copulate and usually must feed. Thus six (rarely five) full meals are sufficient for the bug to attain maturity after it has hatched.

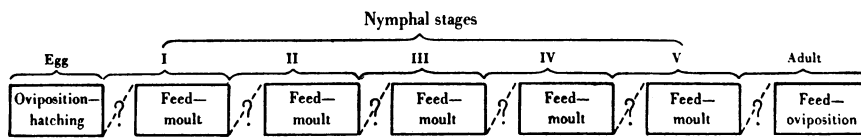

Fig. 5. Plan of life history of *C. lectularius*. Periods between oviposition and hatching, feeding and moulting, or feeding and oviposition can be precisely defined if temperature is known. Periods between moulting and feeding are subject to considerable variation.

It is easy to determine the periods from feeding to moulting in the laboratory. But the periods from moulting to feeding depend on a variety of factors which in nature cause the bugs to take it upon themselves to search for the food which is necessary for further development. These periods are less easy to predict than the periods from feed to moult. Development is shown diagrammatically in Fig. 5: let us consider each phase separately.

B. The rate of development

(a) The incubation period of the egg.

Time of laying. Before dealing with the effects of climate on the incubation period of *Cimex* eggs it is convenient to discuss another factor which must be eliminated before the precise effects of temperature and humidity are considered.

Hase (1917) noticed that eggs dissected from female bugs frequently contained embryos in an advanced stage of development: for, as Cragg (1915, 1920) showed, eggs are fertilized in the follicles. Hase suggested that variation in the duration of the egg stage was partly due to eggs being in different stages of development when laid, and his data showed that eggs dissected from a female took longer to reach the hatching time than those laid normally.

My own results (Table 1) support Hase's explanation. If starved female bed-bugs are fed and then kept at 23° C. they start to lay eggs on the 5th or 6th day after the blood-meal and will continue to oviposit for a period of 8–10 days without another feed. The later the eggs are laid under these conditions the shorter is the period spent in the egg, and although the differences in duration from day to day are slight (about 2·3 %) they are often statistically significant and show the same trend. The variation in time from oviposition to hatching is very considerable with individual eggs; the longest and shortest

Table 1. *Mean duration in days from oviposition to hatching of C. lectularius eggs laid at daily intervals after females were fed once. Females kept for oviposition at 23° C. (73·4° F.), 90 % R.H.*

| Interval blood-meal to oviposition days | Eggs incubated at | | | |
|--|---|----------------|---|----------------|
| | 23° C., 90 % R.H. | | 14° C., 90 % R.H. | |
| | Mean time oviposition to hatching days | No. hatched | Mean time oviposition to hatching days | No. hatched |
| 5 | 9·52 | 33 | 44·55 | 29 |
| 6 | 9·13 | 115 | 43·32 | 77 |
| 7 | 8·82 | 163 | 41·78 | 98 |
| 8 | 8·67 | 205 | 40·64 | 70 |
| 9 | 8·60 | 150 | 39·05 | 58 |
| 10 | 8·11 | 99 | 36·40 | 30 |
| 11 | 8·28 | 40 | 36·32 | 25 |
| 12 | 7·90 | 39 | 37·32 | 25 |
| 13 | 7·58 | 26 | — | — |
| 14 | 5·75 | 12 | — | — |

Table 2. *The duration of the egg stage for C. lectularius eggs. Data for various humidities pooled at each temperature*

| ° C. | ° F. | Mean duration days |
|------|------|-----------------------|
| 35 | 95·0 | 4·56 |
| 34 | 93·2 | 4·50 |
| 30 | 86·0 | 4·83 |
| 27·5 | 81·5 | 5·94 |
| 23 | 73·4 | 9·12 |
| 17·8 | 64·0 | 20·89 |
| 16·1 | 61·0 | 28·92 |
| 14 | 57·2 | 40·66 |
| 13 | 55·4 | 48·67 |

observed times from oviposition to hatching were 3 and 14 days at 23° C. and 22 and 52 days at 14° C. (For further details see Johnson, 1940*a*.)

Constant temperatures and humidities. Periods from oviposition to hatching of *C. lectularius* eggs kept at constant temperatures are given in Table 2. All eggs in these experiments were laid at 23° C. (73·4° F.) and placed at the experimental temperatures within the first 24 hr. from oviposition. Under these conditions no eggs hatched at 37° C. (98·6° F.) or at temperatures below 13° C. (55·4° F.). The times for development shown in Table 2 are not considered to have serious errors due to the factors discussed in the preceding section,

since the stock females which laid the eggs were fed twice weekly, thus ensuring a uniform oviposition rate, with all eggs spending the same time in the female.

Recent work (Johnson, 1940*a*) confirms the observations of Mellanby (1935) and of Geisthardt (1937) that a wide range of humidity is without effect on the duration of the egg stage.

To study the relation of temperature and rate of development the developmental times for different humidities have been pooled at each temperature (Table 2 and Fig. 6). Geisthardt records a slight retardation in duration of the

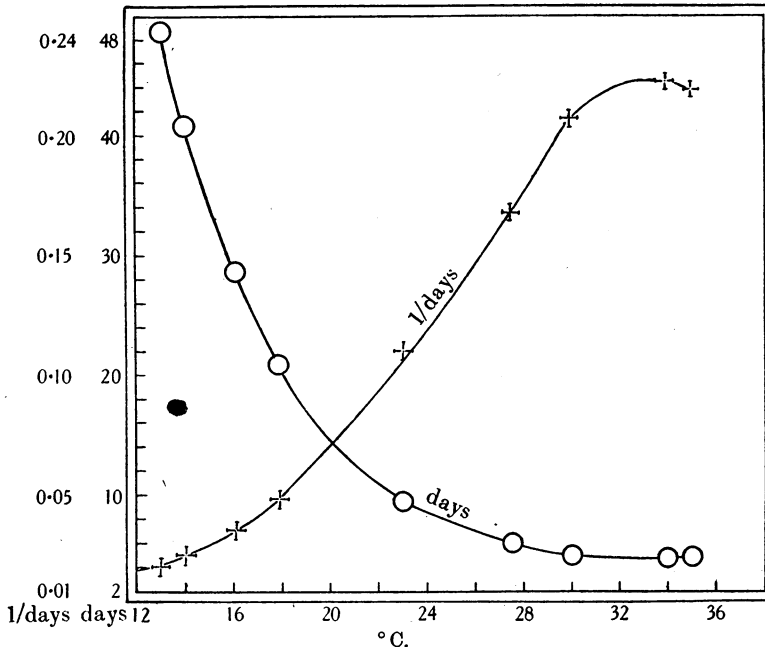

Fig. 6. The mean duration of the period from oviposition to hatching of *C. lectularius* eggs at constant temperatures and the reciprocals of these values plotted against temperature. Data in Table 2. O = duration; + = reciprocal.

egg stage at 35° C. as compared with eggs at 33° C. I have found no significant retardation at these temperatures: unfortunately, it is not possible to test the significance of Geisthardt's values, and even so, the difference may be due to eggs having been laid at different times after the blood-meal.

Some alternating temperatures. In nature constant temperatures are rarely maintained for many hours and room temperatures fluctuate daily over 3–6° C. How is this likely to affect the developmental times?

Only two experiments have, however, been made with alternating temperatures: 90% relative humidity was used at all temperatures. They are discussed in detail elsewhere (Johnson, 1940*a*) and will only be summarized here.

(1) Eggs were placed alternately at 23 and 13.1° C. for 24 hr. at each temperature until the maximum number had hatched. The transfer from one temperature to the other was abrupt, not gradual.

(2) A similar experiment was made with alternating temperatures of 27.8 and 17.5° C.

The results of the experiments are:

| | Mean duration days | Mean duration at | |
|--|--------------------|------------------|-----------|
| | | High temp. | Low temp. |
| (1) 23 \rightleftharpoons 13.1° C. | 14.12 | 7.49 | 6.63 |
| Control at 17.9° C. | 21.69 | — | — |
| (2) 27.8 \rightleftharpoons 17.5° C. | 8.45 | 4.66 | 3.79 |
| Expected at 22.7° C. | 9.70 | — | — |

There is thus a decrease in the time from oviposition to hatching when the temperature alternates between the limits used, compared with the time taken to hatch at a constant temperature midway between the alternating temperatures. But a daily fluctuation of $\pm 2.5^\circ$ C. is more usual in English houses than a fluctuation of $\pm 5.0^\circ$ C. We might therefore expect a slight shortening of about 10–15% of the developmental time for eggs in nature compared with the time taken if room temperatures were constant at a certain value instead of fluctuating about it.

Table 3. *Complete development at constant temperatures from hatching to adult (in days). (Egg stage and prefeeding periods omitted.) Mean time = feed to moult. Rabbit and man as hosts*

| Instar | ... | | I | | II | | III | | IV | | V | | Total time days | | | | |
|--------|------|-----------------------------|----------------|--------------|----------------|--------------|----------------|--------------|----------------|--------------|----------------|--------------|-----------------|-------|------|----|--------|
| | ° C. | ° F. | Mean time days | No. moult-ed | Mean time days | No. moult-ed | Mean time days | No. moult-ed | Mean time days | No. moult-ed | Mean time days | No. moult-ed | | | | | |
| 34.5 | 94.1 | 2.08 | 0.49 | 57 | 2.18 | 0.50 | 56 | 3.12 | 0.49 | 21 | 3.40 | 0.30 | 10 | 4.50 | 0.0 | 2 | 15.28 |
| 28 | 82.4 | 2.70 | 0.42 | 58 | 2.50 | 0.15 | 46 | 2.50 | 0.16 | 39 | 2.71 | 0.41 | 38 | 3.66 | 0.36 | 37 | 14.07 |
| 25 | 77.0 | 4.65 | 0.49 | 53 | 4.24 | 0.53 | 46 | 4.32 | 0.43 | 45 | 4.32 | 0.39 | 45 | 6.43 | 0.39 | 45 | 23.96 |
| 23 | 73.4 | 5.18 | 0.49 | 152 | 5.34 | 0.77 | 128 | 5.28 | 0.89 | 111 | 5.35 | 0.72 | 78 | 7.81 | 0.52 | 70 | 28.96 |
| 18 | 64.4 | 11.21 | 1.20 | 174 | 12.04 | 1.93 | 145 | 13.13 | 3.36 | 127 | 13.19 | 1.36 | 114 | 16.01 | 3.05 | 83 | 65.58 |
| 15 | 59.0 | 21.05 | 2.57 | 75 | 24.22 | 3.55 | 83 | 24.49 | 1.92 | 72 | 22.91 | 2.87 | 81 | 26.19 | 2.26 | 78 | 118.86 |
| 13.7 | 56.7 | 25.5 | — | 2 | | | | | | | | | | | | | |
| 13.0 | 55.4 | First instars fail to moult | | | | | | | | | | | | | | | |

(b) *The periods from feeding to moulting of the nymphs.*

After a full blood-meal has been ingested the time required until moulting depends on the temperature of the environment, the amount of blood ingested above the minimum required for moulting, the particular instar, individual variations of the insects themselves, and perhaps also on the amount of activity subsequent to feeding: for the more active insect will utilize a greater proportion of blood to supply energy for movement and less will remain for growth. Individual variations in the insects and minor variations in the size of the meal will make a 'scatter' of moulting times about any mean value even when the temperature is constant. Very many experiments which I have made confirm Rivnay's work (1932a) and show that atmospheric humidity has no effect on the period from feeding to moulting.

In the laboratory it is easy to feed bugs once to repletion and to obtain the mean and extreme periods for each instar at various constant temperatures. Such results are summarized in Table 3. In nature, however, room tem-

peratures fluctuate normally over a range of 3–6° C. and, as with the egg, this should lead to a slight shortening of the developmental times: this is likely to be of little significance in the general picture compared with other factors which may influence the rate at which maturity is attained (see subsections (c) and (d)).

(c) *The periods from moulting to feeding of the nymphs.*

We know very little about the factors which cause bugs to search for food, and the chances of finding it will depend a great deal on such local conditions as the position of the host in relation to the harbourages where the bugs rest and its distance from them. Physical factors such as temperature, humidity, radiation, and perhaps scent, undoubtedly play a part in initiating the search, but we cannot say to what precise extent. Some of these factors are more

Table 4. *First instars hatched, and kept till fed and also after feeding at 25° C. 75% R.H. Placed on rabbit, in tubes, at 25° C. in darkness for 20 min.*

| Period from hatching till feeding in hours (prefeeding period) | No. of bugs offered food | % which moulted |
|--|--------------------------|-----------------|
| 0–13 | 20 | 35 |
| 13–24 | 20 | 80 |
| 24–37 | 20 | 80 |
| 37–49 | 20 | 95 |

Table 5. *Proportion of bugs which moult at 23° C. after a prefeeding period at 23° C. Fed on man at 23° C. for 20 min. in darkness*

| Instar | No. of bugs offered blood | Prefeeding period days | % moult |
|--------|---------------------------|------------------------|---------|
| I | 1423 | 2–3 | 85.2 |
| II | 671 | 1–2 | 95.8 |
| III | 422 | 1–2 | 96.2 |
| IV | 399 | 2–3 | 62.1 |
| V | 112 | 2–4 | 90.2 |

fully discussed in a later section (§ 8) but here we may say that below about 9° C. (48.2° F.) bugs do not move about spontaneously: at the lowest temperatures at which they do move some will probably also feed if an opportunity is presented: but first instars appear to be particularly susceptible to the effects of moderately low temperatures, and I have rarely been able to induce them to feed after they had spent a week or more at 13–15° C.

In the laboratory we can, however, find the minimum time which must elapse after moulting before bugs are able to feed. Tables 4 and 5 give such data for insects kept at 25 and 23° C. respectively after moulting.

It is clear that for some time after hatching (and also after moulting) the majority of bugs are unwilling to feed if given the opportunity. This period at 25° C. lasts for less than 24 hr. At 23° C. it is found that the minimum time for 90–100% of the insects to feed is between 24 and 48 hr. (Table 5). At lower temperatures this prefeeding period must be lengthened considerably for suc-

cessful feeding to occur (Table 6). The minimum periods have not been ascertained for these lower temperatures, but they seem to be about 6 days at 15° C. and 4 days at 18° C. Let us consider Table 6 in which the immature stages were subjected to prefeeding periods at 15, 18 and 23° C. (except first instars which were all kept at 23° C.). In this experiment bugs which, experience tells, had taken sufficient blood to moult at 23° C. were counted. It is possible, therefore, to get a high percentage of insects to gorge with blood even if kept previously at 15° C. (below which most activities practically cease), provided the prefeeding period is sufficiently long. This probably does not apply to first instars which can seldom be induced to feed if they have been kept for a few days at 15° C. beforehand.

Table 6. *Proportions of bugs which gorged to repletion after prefeeding periods spent at 15, 18 and 23° C. (59.0, 64.4 and 73.4° F.) and 90% R.H. Bugs fed on rabbit in darkness at 23° C. All first instars spent prefeeding period at 23° C. Numbers in brackets are numbers of bugs offered blood*

| Prefeeding conditions ... | 15° C. | 18° C. | 23° C. |
|---------------------------|---------------|---------------|---------------|
| | 6-18 days | 5-10 days | 3-6 days |
| Instars | % gorged | | |
| I | — | 96.6 (263) | 100 (100) |
| II | 84.5 (58) | 94.7 (170) | 85 (100) |
| III | 87.2 (78) | 93.0 (142) | 83 (100) |
| IV | 79.4 (63) | 97.5 (122) | 92 (100) |
| V | 84.1 (69) | 95.6 (114) | 94.6 (93) |
| Means and totals | 84.0 (268) | 95.6 (811) | 90.9 (493) |
| (S.E.) ² | 5.03 | 0.52 | 1.68 |

It is doubtless a far cry from such laboratory experiments where bugs are offered food to the happenings in nature where bugs seek it for themselves. And these results must be used with due care. They do, however, fix a time after which it is possible to say that bugs will feed.

I have noticed that if tubes of bugs which were kept at even rather a low temperature (15-18° C.) were placed on the warm ear of a rabbit, the insects tended to congregate at the opposite end of the tube. It seems that the temperature preference is such as to compel them to move *down* the temperature gradient and therefore away from the rabbit's ear. Exactly how far such a reaction would operate in nature when the bug is free to seek food at any time and not offered blood at certain times only is not known.

In view of this qualification, and because the data presented have not been gathered specifically with this problem in view, conclusions can only be most tentative. The problem as a whole is one on which future work should be done systematically, particularly with regard and in relation to the general be-

haviour of the insect. For this reason, the statements which exist in the literature on the rate of development (reviewed by Titschack, 1930) are of little use, since they either omit to state the environmental conditions or make no mention of the length of the prefeeding periods.

(d) *The periods between feeding and oviposition in the adult.*

Virgin female bed-bugs lay no eggs before copulation, and they usually do not mate unless they have fed recently (see p. 381). The time after moulting

Table 7. *Mean number of days from feeding to production of first egg*

| Temp. after mating ° C. | Mean time after feeding till first eggs days | s.d. | No. of ♀ individuals observed |
|----------------------------|---|------|-------------------------------|
| 28 | 2.69 | 0.73 | 16 |
| 25 | 2.94 | 0.50 | 7 |
| 23 | 5.38 | 0.86 | 38 |
| 18 | 9-12 | — | 2 |
| 15 | 23.69 | 4.37 | 32 |

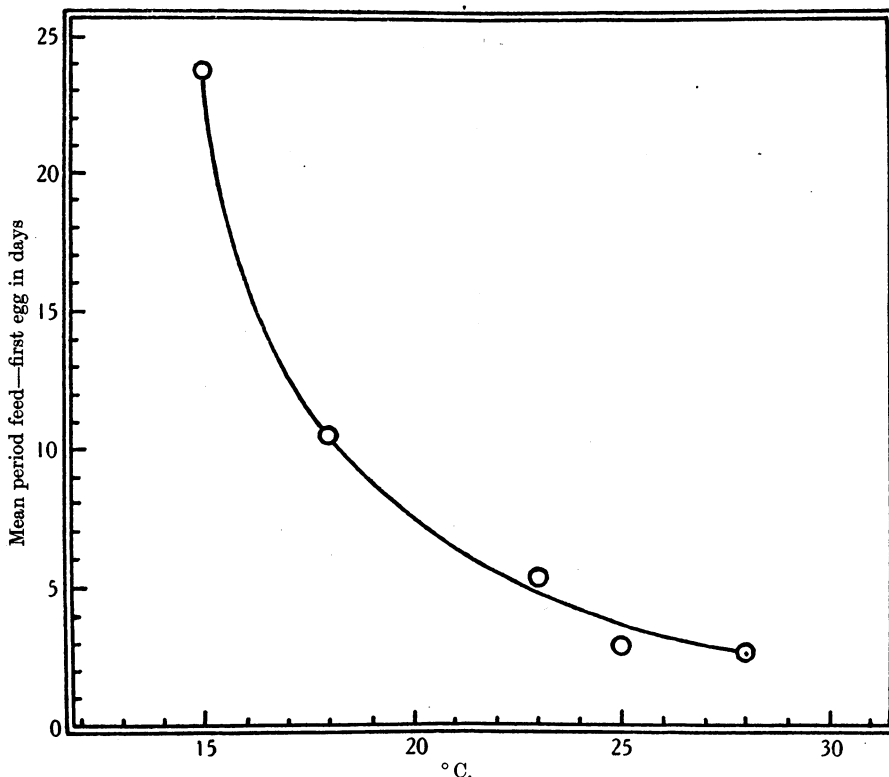

Fig. 7. Mean duration of the period from first feed of adult to laying of first egg. Males and females fed and paired at the same time. Data in Table 7.

from the fifth instar at which mating occurs will depend on the chances of the opposite sexes meeting, but if, as in the laboratory, this can occur within

24 hr. after feeding, we can discover the period between feeding and oviposition if the temperature is known.

In Table 7 and Fig. 7 are results with bugs kept, one of each sex together, in 2 × 1 in. tubes. Both insects (virgins) were fed together and allowed to remain at 23° C. (73·4° F.) for 24 hr., when the males were removed.

(e) *Conclusions and the rate of development of a free-living population.*

It is now possible to form some idea of the average rate at which development may occur under natural conditions at temperatures above 18° C. and if a host can easily be found by the bugs at regular intervals. Below 18° C. other factors operate and make prediction impossible at present (see § 3 D).

Above 18° C. however, if the lengths of the prefeeding periods are fixed arbitrarily, a table and figure can be constructed on the basis of constant-temperature experiments (Table 8 and Fig. 8).

Table 8. *Total period from oviposition to oviposition. Prefeeding periods arbitrarily fixed from data in § 3 B (c)*

| ° C. | ° F. | Duration of egg stage days | Sum of periods from feed-moult for five nymphal instars days | Period from feed to first egg in adult days | Sum of prefeeding periods days | Total days |
|------|------|----------------------------|--|---|--------------------------------|------------|
| 28 | 82·4 | 5·5 | 14 | 2·7 | 12 | 34·2 |
| 25 | 77·0 | 7·1 | 24 | 2·9 | 12 | 46·0 |
| 23 | 73·4 | 9·2 | 29 | 5·4 | 18 | 61·6 |
| 18 | 64·4 | 20·2 | 66 | 9-12 | 30 | 125·2 |
| 15 | 59·0 | 34·0 | 119 | 23·7 | 60 | 236·7 |

It is interesting to compare these deduced times with observations on free-living populations.

Some records of free-living populations on mice are helpful in estimating the approximate times spent between feeds and moults if the bugs are left to choose their feeding times. The methods used are described in detail in Appendix A: cages were inspected once a week, and except where stated as being at room temperature, were kept in incubators in a constant-temperature room. The results appear in Table 9; where adult mice were used the times taken for development agree very closely with those calculated from laboratory experiments (Table 8), even if no prefeeding period is allowed for in making the estimate. In fact at 18° C. the observed time of the free-living bugs to reach the third nymphal stage was shorter than was to be expected, probably due to the fact that the air in a small cage containing a mouse is 2-3° C. higher than the incubator temperature.

It is evident that but a short time—up to 2 days at most—is allowed to elapse between each instar before the bugs take a feed. It is striking, too, that most of the bugs in the population feed within a short time of each other (see Mellanby, 1939*b*, for similar regularity).

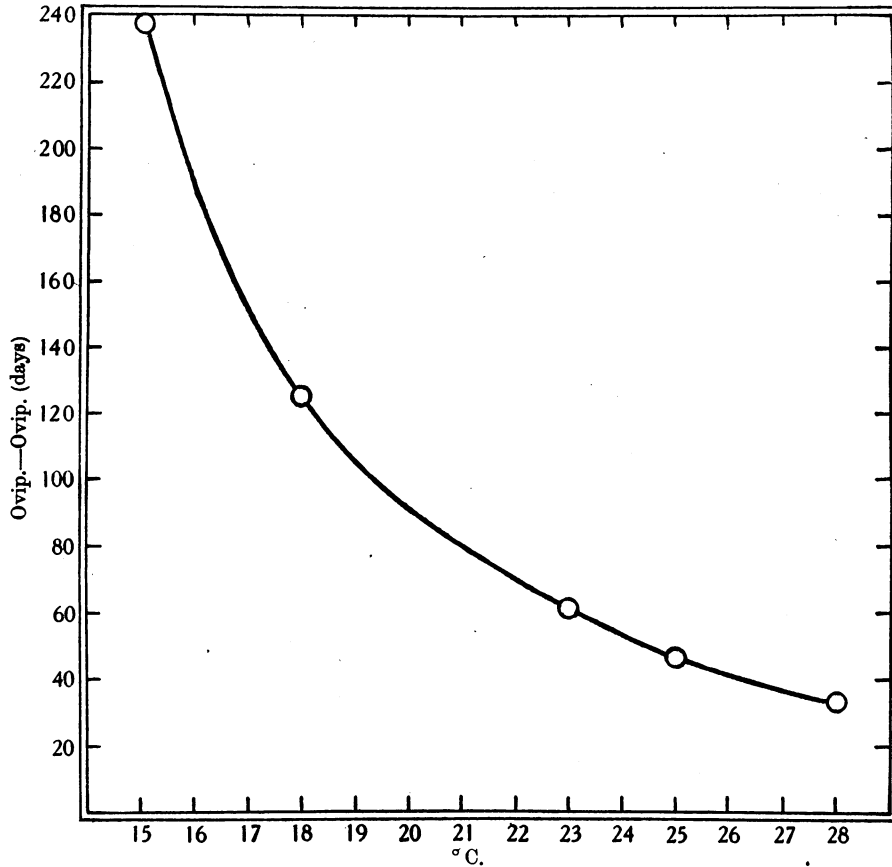

Fig. 8. Mean period from oviposition to oviposition: prefeeding periods arbitrarily fixed. Data in Table 8.

Table 9. Duration of development of *C. lectularius* on a free-living host (mouse) at 23° C. Mouse placed in cage overnight except for Saturdays and Sundays. Cages inspected once a week. All mice were adults except asterisked experiment in which a baby mouse was used. For number of bugs used, see Tables 50 and 51

| Temp. ° C. | Bugs introduced | Stage of development reached | Time days | Approx. expected time (without prefeeding periods) days |
|------------|---|------------------------------|-----------|---|
| 23 | 1st instar (unfed) | 4th instar (fed) | 14-21 | 19 Experiments |
| | | 5th instar (unfed) | 14-21 | 21 repeated |
| | | 5th instar (fed) | 21-28 | 25 three times with same results |
| 23 | 1st instar (unfed) | 1st adult | 21-28 | 29 |
| | | 1st adult | 21-28 | 29 |
| | | 1st adult | 28-36 | 29 |
| | | Eggs from adult | 42-49 | 34 |
| *23 | 1st instar (unfed) | 4th instar (unfed) | 21-28 | 16 |
| | | 5th instar (unfed) | 35-43 | 21 |
| | | Adults | 45-53 | 29 |
| 18 | 1st instar (unfed) | 3rd instar (unfed) | 14-21 | 23 |
| 15 | Experiments failed since mouse ate all bugs before they developed into the next stage | | | |
| Room temp. | 1st instar (unfed) | 5th instar | 42-49 | (Jan.-March) |
| " | Adults | F ₁ adults | 53-60 | (March-April) |

Admittedly a small cage with a mouse confines bugs closely to the host, and as their difficulty of finding it is reduced to a minimum, little time can be wasted in a fruitless search. Also the stimulus due to the presence of a host (if it exists, see Fig. 30) may be very great.

With a baby mouse these factors are not so favourable, and we see that the observed times are longer than the expected ones. This condition is perhaps more nearly comparable to the situation of a man in an ordinary sized room.

Thus we can conclude that if left to themselves at summer temperatures and perhaps at spring and early autumn ones too, bugs may attempt to find food within a day or two after moulting. The fact that they live at a constant temperature in the above experiments and are not subjected to the stimulus of rising temperatures or the depressing effect of falling ones (see p. 427) appears to

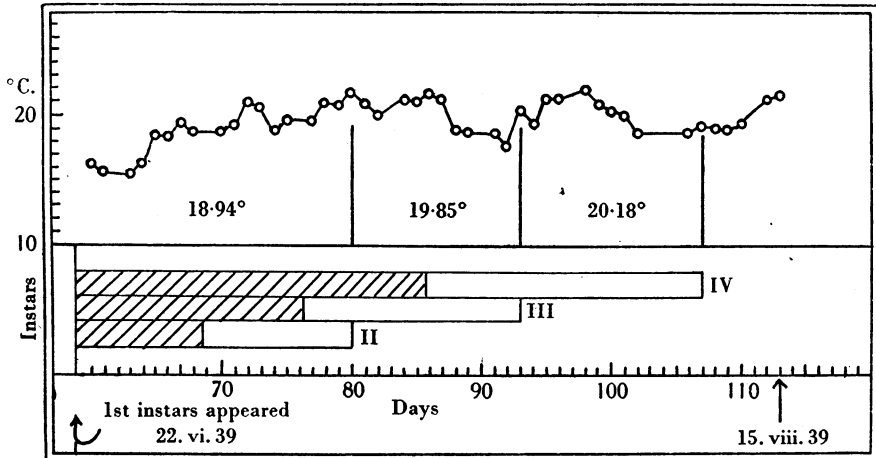



Fig. 9. Temperatures (above) in the experimental hut from June to August 1939: below, dates at which one would expect successive instars (II, III, IV) to appear, and dates of observed occurrence.  expected;  observed.

be favourable to their feeding activities. Of course too close a comparison of a room and a mouse cage cannot be entertained—except in a room where bugs are resting very close to the host, e.g. in a bedstead.

In a small room development may be slow in spite of a relatively high temperature if the host is not quickly found: this is shown by experiments in an experimental hut (see description of hut in Appendix A) in which a chicken was placed each night. The experiment was run from 22 June to 15 August. The appearance of second and subsequent instars was always later than would have been expected, had development depended only on temperature. For instance, only one fourth instar was present in the hut at a date when first-generation adults should have been numerous had development proceeded at an average rate for the temperature at the time as judged by laboratory experiments (Fig. 9).

The reason for such slow development was undoubtedly the failure of bugs

to find the host, for bugs were well dispersed over all the walls of the hut, and most of the first instars produced wandered extensively.

Thus although laboratory experiments are a good guide to the maximum possibilities for rate of development the actual process in nature will depend very greatly on the chances with which the bugs encounter the host.

C. *The influence of environment on the proportions of normal eggs which develop and hatch*

(a) *Factors affecting the developmental-hatching threshold.*

Definitions. The term 'threshold' is used in the sense of Shelford (1929), who writes: 'The threshold of development is that intensity or amount of any factor immediately above which development begins to be perceptible in amount.'

With the egg of *C. lectularius* the lowest constant temperature at which complete development, from oviposition to the conclusion of the hatching process, will occur is 13° C. (55.4° F.). This cannot rightly be called the developmental threshold, however, according to Shelford's definition, since a slight amount of development may occur below 13° C. although the embryo fails to hatch (Johnson, 1940*a*). Neither is 13° C. the hatching threshold, for if eggs are incubated till just before eclosion they will hatch at 8° C. (46.4° F.).

Table 10. *Hatching of C. lectularius eggs laid at 23° C. and then placed at a constant temperature of 13 ± 0.1° C. and various humidities*

| % R.H. | No. eggs used | No. eggs hatched | No. died hatching | Control from same egg batches at 23° C., 90% R.H. | | |
|--------|---------------|------------------|-------------------|---|-------------|-----------|
| | | | | No. used | No. hatched | % hatched |
| 99-100 | 100 | 0 | 0 | 31 | 29 | 93.5 |
| 90 | 100 | 1 | 1 | 79 | 76 | 96.2 |
| 75 | 226 | 1 | 11 | 119 | 114 | 95.8 |
| 13 | 160 | 0 | 0 | 110 | 105 | 95.5 |

I have proposed therefore to call the constant temperature of 13° C. the *developmental-hatching threshold* as distinct from the *hatching threshold* and the *developmental threshold*.

Alternating temperature. It seemed possible, in view of the acceleration in development associated with alternating temperatures, that eggs might be induced to hatch at a slightly lower mean temperature than 13° C. if fluctuations in temperature occurred. An experiment with fifty eggs at 90% R.H. was therefore made with a temperature with a slow mean daily fluctuation of ± 2.2° C. about a mean of 11.5° C. This range was chosen on account of its similarity to the temperature fluctuations likely to be found in rooms in English houses. None of the eggs hatched, however, although the experiment was continued for 80 days. It seems, therefore, that the mean temperatures are probably a good guide to the possibility of hatching in nature.

Atmospheric humidity. Table 10 indicates the effect of humidity at the developmental-hatching threshold.

Although the numbers hatched are very small, there is an indication that the humidity has a slight effect. The range 75–90 % is the most favourable to hatching among those investigated: this is reflected more particularly in the number which died during the hatching process than in those which emerged successfully. Embryos which die while hatching usually manage to emerge from the chorion but are unable to withdraw the hind-legs from the embryonic cuticle.

(b) *The effect of the temperature during embryonic development on the hatching threshold.*

It was pointed out in a previous section that if eggs are incubated until nearly ready to hatch, they can be placed at temperatures well below 13° C. (the developmental-hatching threshold) and they will hatch successfully. I have called the lowest temperature at which the hatching process itself occurs the hatching threshold.

It is very difficult to determine the exact hatching threshold accurately. For in the first place no sharp break occurs between the last stages of development and the commencement of hatching: and it is difficult to estimate when batches of eggs are in exactly the same condition if comparative experiments are to be made. Even if an arbitrary point in the later stages of development is selected, it is difficult to procure two egg batches both developed exactly to this point. The procedure in my experiments was as follows:

Eggs were obtained at 23° C. and 90 % R.H. and were incubated until 20–30 % of the original number had hatched. The remaining unhatched eggs were then placed at low temperatures and the hatching recorded every few days. It was thought that the hatching threshold might be affected by the temperature at which eggs had been incubated till the arbitrary point had been reached, and the experiments were, therefore, made with the primary incubation at 15, 18 and 23° C.

Eggs laid at 23° C., 90 % R.H., over a period of 4 days by a stock of females were split up into three batches; these were placed respectively at 23, 18 and 15° C. and at 90 % R.H. Controls from each batch were kept at 18° C., 90 % R.H. An attempt was made to remove eggs to the low temperatures when the same percentage had hatched in each batch at the three above temperatures, but this proved very difficult. For when hatching is once started, a few minutes or half an hour may result in an extra 10 % hatch above that desired. This fact, however, indicates that a considerable proportion of the eggs in the different batches are in a very similar stage of development, even if the exact proportion hatched in each batch is not the same.

The experiments summarized in Table 11 are beset with difficulties; these are fully discussed elsewhere (Johnson, 1940*a*).

The lowest threshold for hatching yet found with the eggs of *C. lectularius* is 8° C. (46.4° F.). At this temperature the two experiments with the preliminary incubation of 15° C. show very similar percentage hatches; there is,

however, a much higher percentage hatch from 18° C. (31.3 % compared with 12.8 and 11.4 %) and the differences are statistically significant although the numbers hatched are small. No eggs which had been previously incubated at 23° C. hatched at 8° C. Thus both 15 and 18° C. appear to be more favourable temperatures than 23° C. for preliminary incubation of eggs before they hatch at 8° C.

Consider now the incubation at 9° C. Eggs from 18° C. have a higher percentage hatch than eggs from either 23 or 15° C., and the differences are always statistically significant. Moreover, preliminary incubation at 23 and at 15° C. produces similar hatches—17.4 and 4.3 % and 3.1 and 17.0 % for 23 and 15° C. in the first and second experiments respectively: the former percentages are significantly different, the latter are not. It appears, therefore, that at this temperature there is little to choose between eggs incubated at 23 and 15° C. in their ability to hatch at 9° C., but those from 18° C. are much more successful.

Table 11. *The effect of the temperature during embryonic development on the hatching threshold. Eggs laid at 23° C., 90 % R.H., and incubated till some had hatched at 23, 18 and 15° C., then placed at approximately 10, 9 and 8° C. For further details see Johnson (1940a)*

| Exp. | Temp. of preliminary incubation ° C. | % hatched after preliminary incubation | No. remaining put at each low temperature | % hatch of remainder corrected for mortality in control Approx. temp. of incubation, ° C. | | |
|------|--------------------------------------|--|---|--|------|------|
| | | | | 10 | 9 | 8 |
| 1 | 23 | 18.2 | 47 | 49.3 | 17.4 | 0 |
| | 18 | 20.8 | 56 | 70.3 | 52.1 | 31.3 |
| | 15 | 32.7 | 48 | 47.0 | 4.3 | 12.8 |
| 2 | 23 | 28.8 | 52 | 43.8 | 3.1 | 0 |
| | 15 | 25.5 | 30 | 45.5 | 17.0 | 11.4 |

With the incubations at 10° C. there is again no evidence that preliminary incubation at 23 and at 15° C. affect subsequent hatching. In fact, the proportions hatched are remarkably close and with no statistically significant differences. But, as with the exposure to 8 and 9° C. eggs first incubated at 18° C. hatch more successfully at 10° C. than those first incubated at 23 or 15° C., and the differences are statistically significant.

Thus there appears to be a slight adaptation of the hatching process to low temperatures: 18° C. appears to be a more favourable temperature than 23° C., and possibly also more favourable than 15° C. for subsequent hatching of the eggs at temperatures near the hatching threshold. It may be possible to demonstrate that the hatching threshold is below 8° C., particularly if a more favourable temperature than 18° C. can be found for preliminary incubation and if larger numbers of eggs are procured which are nearer to eclosion when placed at the threshold temperature.

(c) *Constant temperatures and humidities: above the developmental-hatching threshold.*

If a stock of bed-bugs is kept at 23° C. with males and females in approximately equal numbers so as to ensure a constantly high proportion of fertilized females, then there is usually a slight mortality in the eggs which are laid, even if kept at optimal temperatures, quite apart from unfertilized (or 'taub' eggs of German authors) which appear when the numbers of sperms are exhausted. The cause of this mortality is unknown, for the eggs have a normal appearance and usually undergo some development. In nature another cause for egg mortality might be the sealing of the caps of the eggs by faeces from nymphs and adults. This is likely to occur where a harbourage is considerably crowded with bugs.

Table 12. *Percentage hatch of C. lectularius eggs at various constant temperatures and humidities above the developmental-hatching threshold. All eggs laid at 23° C., 90% R.H. Percentage hatch not corrected for control mortality. (See Fig. 10)*

| ° C. | ° F. | % R.H. | Actual % hatch | No. of eggs used | S.E. % | Controls 23° C., 90% R.H. |
|------|------|--------|----------------|------------------|--------|----------------------------------|
| 13.1 | 55.5 | 99-100 | 0 | 100 | — | From same batches over 90% hatch |
| | | 90 | 1.0 | 100 | 1.00 | |
| | | 75 | 0.4 | 226 | 0.42 | |
| | | 13 | 0 | 60 | — | |
| | | 7 | 0 | 100 | — | |
| 14.0 | 57.2 | 90 | 58.9 | 699 | 1.86 | „ |
| 15.0 | 59.0 | 7 | 67.1 | 70 | 5.62 | 88.3% hatch |
| 16.0 | 60.8 | 90 | 91.0 | 100 | 2.86 | Over 90% hatch |
| | | 75 | 89.5 | 200 | 2.17 | |
| | | 7 | 80.5 | 200 | 2.80 | |
| 18.0 | 64.4 | 90 | 89.0 | 181 | 2.33 | — |
| | | 75 | 86.0 | 100 | 3.47 | |
| | | 7 | 77.0 | 100 | 4.21 | |
| 23.0 | 73.4 | 99-100 | 87.9 | 99 | 3.28 | — |
| | | 90 | 93.1 | 1786 | 0.60 | |
| | | 75 | 97.0 | 99 | 1.71 | |
| | | 7 | 90.9 | 275 | 1.73 | |
| 28.0 | 82.4 | 99-100 | 96.0 | 100 | 1.96 | — |
| | | 75 | 90.0 | 100 | 3.00 | |
| | | 7 | 93.0 | 100 | 2.55 | |
| 30.0 | 86.0 | 99-100 | 85.8 | 148 | 2.87 | — |
| | | 75 | 91.3 | 309 | 1.60 | |
| | | 7 | 90.0 | 50 | 4.24 | |
| 34.0 | 93.2 | 90 | 86.0 | 100 | 3.47 | — |
| | | 7 | 74.0 | 100 | 4.39 | |
| 34.5 | 94.1 | 99-100 | 63.2 | 114 | 4.52 | Over 90% hatch |
| | | 75 | 87.8 | 115 | 3.05 | |
| | | 7 | 70.2 | 67 | 5.59 | |
| 35.5 | 95.9 | 75 | 90.0 | 50 | 4.24 | „ |
| | | 7 | 32.0 | 50 | 6.60 | |
| 37.0 | 98.6 | Low | 0 | 100 | — | „ |

(d) *The effect of temperature and humidity during incubation.*

Consider, in Table 12 and Fig. 10, the eggs which were laid at 23° C. and incubated at various temperatures: all these eggs appeared normal 24 hr.

after oviposition. As the temperature rises above 13° C. the optimum range is approached very quickly and it extends from about 16° C. (60·8° F.) to beyond 30° C. (86·0° F.). At temperatures above 30° C. mortality sets in very quickly when the humidity is low till at 37° C. no eggs hatch. At the higher humidities of 75–90 % R.H. the optimum range of temperature is wider, particularly at the high temperatures, and extends to about 34–35° C.

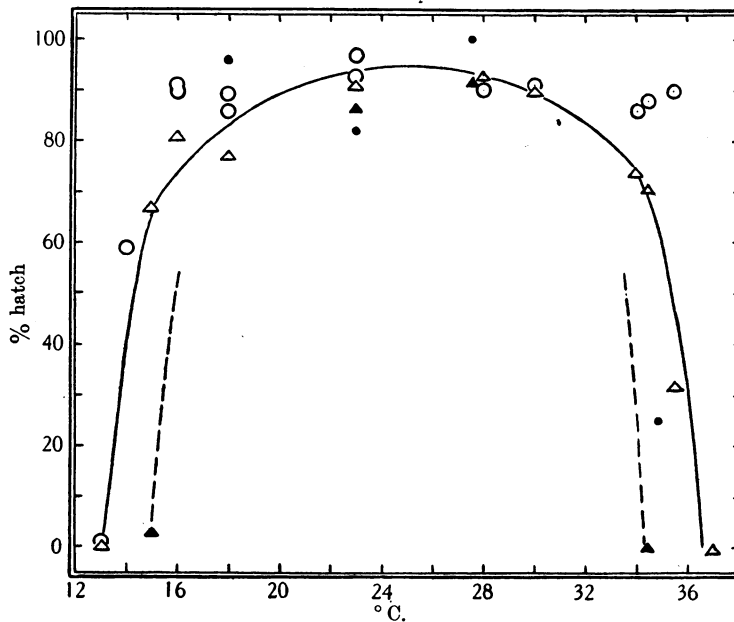

Fig. 10. Percentage hatch of *C. lectularius* eggs laid at 23 and 15° C. and then incubated at various constant temperatures and humidities. Lines drawn by hand through the points for the low humidities. Data in Tables 12 and 13, but batches incubated at 100% R.H. are omitted from the figure. ○ laid at 23° C.; 75–90% R.H. during incubation. Δ laid at 23° C.; 7% R.H. during incubation. • laid at 15° C.; 90–95% R.H. during incubation. ▲ laid at 15° C.; 7% R.H. during incubation.

Humidity appears to have a very slight but noticeable effect on mortality within the greater part of the optimum range of temperatures: very low humidities are there slightly less favourable, either to the development or to the hatching of eggs, than at 90% R.H. Relative humidities of 99–100% appear to be rather less favourable than those of 90%, at least towards the higher temperatures.

These results do not agree precisely with Mellanby's statement (1935) 'that below 30° C. the eggs hatched in as great numbers whatever the humidity', but they agree largely with the results of Geisthardt who states 70% R.H. to be an optimal humidity from 16·4 to 34·4° C. He claims 100% R.H. to be optimal between 19·5 and 30·5° C. however, but gives no data. The effects of humidity are most noticeable at the high temperatures outside the optimal range.

(e) The effect of the temperature at oviposition.

The results of experiments made to test whether the temperature at which eggs are allowed to develop and to be laid affects the proportions which subsequently hatch have been discussed in another publication (Johnson, 1940*a*). They may be briefly summarized here (Table 13 and Fig. 10).

Eggs laid at 15° C. will show almost a total mortality if incubated at 15° C., while many of those laid at 23° C. will hatch at 15° C. At the upper temperature limit for development with hatching the same effect is seen. In the intermediate zone between approximately 18 and 27.5° C. the eggs hatch with equal success, whether they are laid at 15 or 23° C.

These results apply only to the low relative humidity of 7%. At a higher humidity the upper and lower limits for eggs laid at 15° C. may approximate to the limits for those laid at 23° C.

There thus appears to be no adaptation to relatively low temperatures: at least as far as a comparison of 15 and 23° C. is concerned.

Table 13. *The effect of the temperature of oviposition on the percentage hatch of C. lectularius eggs at various constant temperatures above the developmental-hatching threshold. Eggs laid at 15 and 23° C.*

| Oviposition temp. | | 15° C. | | | 23° C. | | | Sig. test |
|------------------------|--------|---------|----------|--------|---------|----------|--------|-----------|
| During incubation ° C. | % R.H. | % hatch | No. used | S.E. % | % hatch | No. used | S.E. % | |
| 15 | 7 | 2.9 | 35 | 2.84 | 67.1 | 70 | 5.62 | Sig. |
| 23 | 7 | 86.4 | 44 | 5.17 | 88.3 | 60 | 4.15 | Not sig. |
| 34.4 | 7 | 0 | 35 | — | 70.2 | 67 | 5.59 | Sig. |

(f) Survival at temperatures below the developmental-hatching threshold.

In unheated rooms in England the winter temperatures are usually well below 13° C., the developmental-hatching threshold, for several months at a time (Figs. 2; 3), although temperatures below 0° C. (32.0° F.) are not often sustained for many hours. It is important, therefore, for practical purposes, to know how long eggs in various stages of development and which have been laid at different temperatures can remain alive and capable of hatching. Knowledge of the mortality among eggs after varying periods of exposure to such subthreshold temperatures is relevant also in studies of bed-bug populations. These problems have received detailed attention in a separate paper (Johnson, 1940*a*): the results are briefly summarized here.

The effect of age. Since embryos may be in different stages of development when eggs are laid, it is necessary to know if such differences are likely to affect the results of exposure experiments. Observations have, therefore, been made on the effects of exposures to a temperature of 7.7° C. on eggs in different stages of development.

Batches of eggs were incubated at 23° C. (the temperature at which they were laid) and 90% R.H. for periods from within 24 hr. up to 7 days after oviposition, and they were then placed at 7.7° C. and 90% R.H. After various

periods they were extracted and incubated at 23° C., 90% R.H., until the maximum number had hatched.

There appears to be little difference in susceptibility to the low temperature with eggs kept at 23° C. until the fourth day after oviposition. The median exposures for death are not significantly different between eggs with 1, 2 and 4 days' preliminary incubation.

The median exposure for death, i.e. the calculated exposure for 50% mortality, is significantly shorter with the seven than with the six days' preliminary incubation, and significantly shorter in both of these than in eggs up to 4 days old before exposure (Table 14).

Table 14. *The age of C. lectularius eggs and their resistance to low temperatures. The exposure of C. lectularius eggs of different ages to 7.7° C., 90% R.H., necessary to cause 50% mortality. This exposure has been calculated from the best fitting line from the experimental data*

| Days of preliminary incubation at 23° C. | Exposure in days to 7.7° C. for 50% mortality | Variance |
|--|---|----------|
| 2 | 30.5 | 0.68 |
| 4 | 29.1 | 2.51 |
| 4 | 32.3 | 1.26 |
| 6 | 25.6 | 0.48 |
| 7 | 23.4 | 0.43 |

Thus the longer the eggs are kept at 23° C. after the fourth day, the more quickly they die when subjected to 7.7° C. This may be due to the advanced condition of the embryo or to an acclimatization effect associated with the longer exposure to 23° C. These results do not agree with those of Geisthardt. He kept eggs at 27° C. till they were nearly ready to hatch and then subjected them to a temperature of 0–2° C. for 7 days. 92% of the eggs hatched compared with 15% of eggs exposed to 0–2° C. when they were only 24 hr. old. Geisthardt gives no details of the experiment, however, and did not use a control for the young eggs. Omori (1938) found that the percentage hatch on exposure to 0° C. for 14 days is higher with young than with old eggs, but the reverse was true for 7-day exposures. Definite conclusions for the general behaviour of eggs of different ages to low temperatures cannot, however, be drawn from the experiments of Geisthardt and Omori, since neither of these workers found the time required for a median or mean exposure for death. Variations in the scatter of mortalities about the median time due to inherent differences in the material rather than differences due to the age of the eggs may produce results which appear to be contradictory.

The effect of temperature. Eggs laid at 23° C. within 3 days from the female's blood-meal were collected within 24 hr. after oviposition and then placed at various low temperatures and different humidities. Samples were extracted after definite periods and incubated at 23° C. and 90% R.H. A control batch of

from twenty to thirty eggs was taken from the same batch as the experimental eggs in each case and used for correcting the experimental mortalities.

Table 15 gives the median exposures for death and their variances for a number of temperature and humidity combinations. Those data which are asterisked are at two similar saturation deficiencies—between 5.1 and 5.8 and between 2.4 and 2.9 mm. Fig. 11 illustrates the results graphically. At both saturation deficiencies a similar relation of mean survival time to temperature is evident, and the lower the temperature between 0 and 12° C. the shorter is the survival time.

Table 15. *Exposures for 50% mortality (median exposure for death) and for 99.99% mortality for C. lectularius eggs at temperatures between 1 and 13° C. and various humidities. Asterisked data are used in Fig. 11 for the effect of temperature at similar saturation deficiencies*

| Mean | | % R.H. | Sat. def. mm. | Exposures and variances (italic) in days | |
|-----------|------|--------|------------------|---|---------------------|
| ° C. | ° F. | | | 50% mortality | 99.99% mortality |
| 1.0±0.8 | 33.8 | 89 | 0.5 | 11.1 <i>1.098</i> | 38.7 |
| 1.1±0.8 | 34.0 | 5 | 4.7 | 11.6 <i>1.199</i> | 39.8 |
| 4.1±0.8 | 39.4 | 89 | 0.7 | 23.8 <i>1.368</i> | 65.8 |
| 4.2±0.8 | 39.6 | 70 | 1.8 | 22.9 <i>1.120</i> | 55.6 |
| *4.0±0.8 | 39.2 | 60 | 2.4 | 26.1 <i>8.322</i> | 59.2 |
| *4.0±0.8 | 39.2 | 15 | 5.1 | 21.0 <i>1.866</i> | 60.5 |
| *4.3±0.8 | 39.7 | 5 | 5.8 | 17.8 <i>0.522</i> | 47.4 |
| *6.7±1.0 | 44.1 | 65 | 2.6 | 24.8 <i>1.331</i> | 51.8 |
| *6.9±1.0 | 44.4 | 29 | 5.3 | 24.0 <i>1.516</i> | 54.5 |
| 7.7±1.0 | 45.9 | 90 | 0.8 | 30.2 <i>0.744</i> | 68.3 |
| 7.8±1.0 | 46.0 | 9 | 7.2 | 23.9 <i>0.889</i> | 50.1 |
| *9.1±1.1 | 48.4 | 72 | 2.4 | 28.4 <i>1.549</i> | 61.7 |
| *9.3±1.1 | 48.7 | 42 | 5.1 | 25.7 <i>1.535</i> | 51.4 |
| 9.8±1.1 | 49.6 | 89 | 1.0 | 25.8 <i>0.774</i> | 55.0 |
| 9.8±1.1 | 49.6 | 6 | 8.5 | 23.5 <i>0.922</i> | 52.5 |
| 11.7±0.8 | 53.1 | 89 | 1.1 | 26.7 <i>1.409</i> | 73.3 |
| 11.7±0.8 | 53.1 | 5 | 9.8 | 19.8 <i>1.217</i> | 55.8 |
| *12.1±1.0 | 53.8 | 73 | 2.9 | 33.9 <i>1.610</i> | 79.8 |
| *12.1±1.0 | — | 46 | 5.7 | 28.9 <i>1.212</i> | 62.5 |
| 12.1±1.0 | — | 25 | 7.9 | 24.4 <i>0.854</i> | 49.3 |
| 12.1±1.0 | — | 0.1 | 10.6 | 23.3 <i>0.693</i> | 43.6 |
| 13.0±0.2 | 55.4 | 0.1 | 11.1 | 25.7 <i>1.606</i> | 62.3 |

For practical purposes, in bed-bug control the knowledge of exposure at which a complete mortality is to be expected is more important than that for the exposure for a 50% mortality. Exposures which would be expected to produce 99.99% mortality have, therefore, been calculated (Table 15) from the lines fitted to the experimental data. With these values, as with those for 50% mortality, the higher the temperature between 0 and 12° C. the longer do eggs survive when humidity (as measured by saturation deficiency) is constant. The relationship is not so well marked as with the exposure for 50% mortality, and reasons for this have been suggested elsewhere (Johnson, 1940a).

These calculated exposures for 99.99% mortality are usually longer than observed exposures for 100% mortality in the experiments. Nevertheless, the

calculated values are probably safer for practical purposes, since account is taken of the variation in all the exposed experimental samples and not merely the sample which shows 100% mortality.

The effect of humidity. It can hardly be expected that the effect of humidity between 1 and 13° C. would be very marked, for the greatest saturation deficit is only 11.1 mm.

A relatively wide range of humidity at 1° C. appears to have no effect on survival time (Table 15). At 12° C. the longest survival time occurs in the

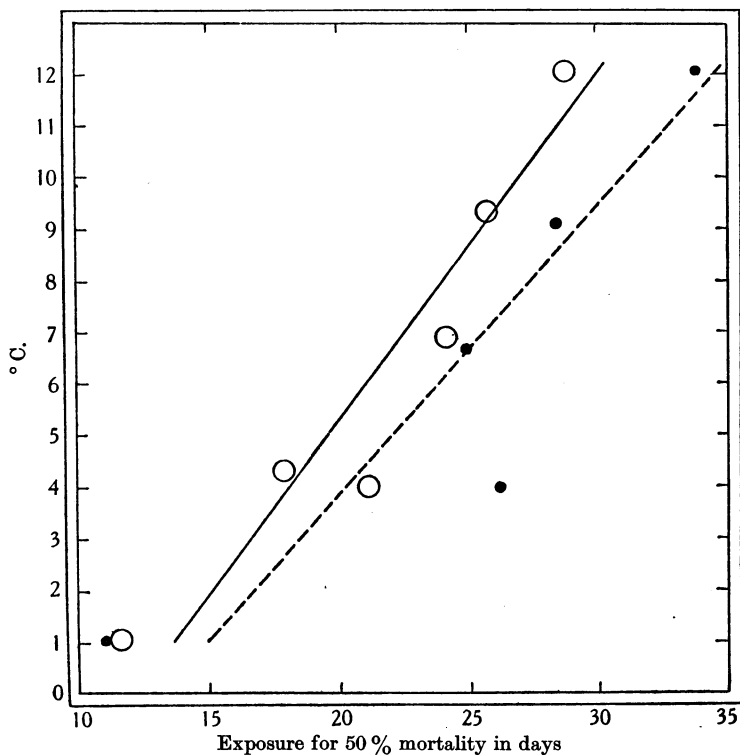

Fig. 11. Exposure for 50% mortality of *C. lectularius* eggs at various temperatures but at constant saturation deficits. ○ = sat. def. of 5.1-5.8 mm.; ● = sat. def. of 2.4-2.9 mm. Data in Table 15 (asterisked).

dampest air (i.e. that with the lowest saturation deficit). Over the whole temperature range these lowest saturation deficits seem to favour survival although the effect is very slight, and as far as the median exposures for death at approximately 2.4 and 5.5 mm. (Fig. 11) the differences are not statistically significant. At 99.99% mortality the effect of humidity on survival is evident only at the higher humidities. The effect of humidity on survival is shown in Fig. 12. It is slight but definite. Data in Table 15 suggest that the range of relative humidity between 50 and 80% may be the most favourable, but the differences are too small for a safe generalization.

The temperature of oviposition. As we have already seen, the temperature at which eggs are laid or at which they form inside the female affects the survival above 13° C. and hatching at the hatching threshold. Experiments have been made to test the effects of temperatures at which eggs were laid on survival below 13° C. (Johnson, 1940*a*). These indicate, rather unexpectedly, that the temperature at which the eggs are laid (between 23 and 15° C.) has no effect on the survival of eggs at 10° C. (50·0° F.).

Results of other workers. Bacot (1914), Hase (1930) and Omori (1938) have worked with eggs at temperatures below 13° C. My results agree well with

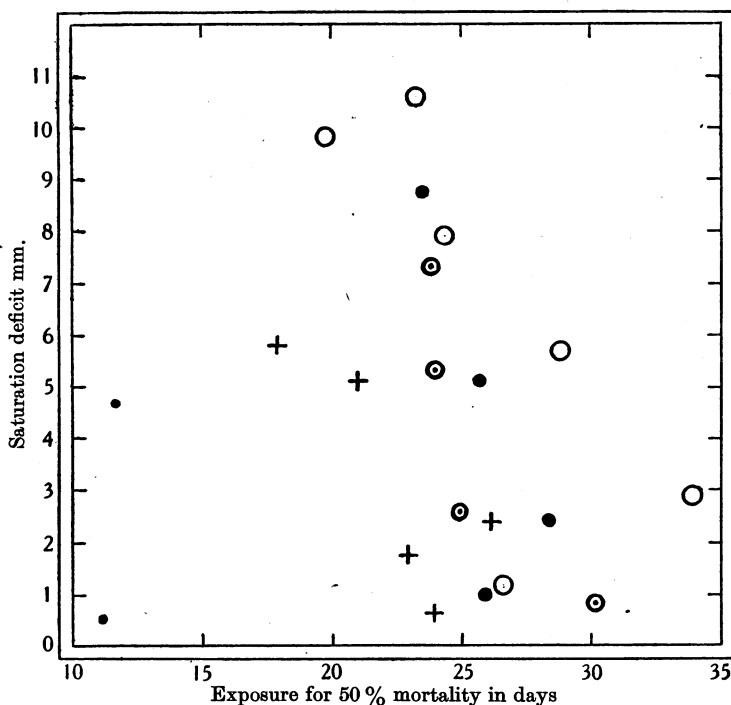

Fig. 12. Exposure for 50% mortality of *C. lectularius* eggs at various saturation deficits and constant temperatures. ● 1·0-1·1° C.; + 4·0-4·3° C.; ⊙ 6·7-7·8° C.; ● 9·1-9·8° C.; ○ 11·7-12·1° C. Data in Table 15.

those of Hase at 2° C. It has been stated (Uvarov, 1931) that even short exposures of 3 days to 2° C. result in some mortality, for only 93 % of the eggs hatched. But it is most probable that this mortality was not due to low temperature; for my controls, which had not been exposed to low temperatures, almost invariably showed such a slight mortality, and this has been the experience of all other workers with *C. lectularius*.

Bacot (1914), using eggs 0-3 days old (and laid at 24° C.), found that 46 % mortality occurred after an exposure of 31 days to temperatures varying between 4·4 and 12·8° C. with an average of 8·8° C. (48° F.). My results at comparable temperatures agree fairly well with this result (Table 15). I did

not experiment below 1° C. where 35 days was necessary for complete mortality (38·7 and 39·8 days for calculated exposures for 99·99% mortality). It would appear from the results of Bacot (1914) and Omori (1938) that at temperatures at and just below 0° C. the eggs die noticeably more quickly than at 1° C.

Bacot's figures are as follows for exposures at -2·3-0° C.:

| Age of eggs days | Exposure days | % mortality |
|---------------------|------------------|-------------|
| 0-6 | 1 | 5 |
| 0-1 | 2 | 7 |
| 0-3 | 8 | 76 |
| 0-6 | 10 | 100 |
| 0-2 | 10 | 100 |

Omori found that 100% mortality occurred after 21 days' exposure of eggs of *C. lectularius* to 0° C.

D. *The proportions of nymphs which moult after feeding*

(a) *The effect of the temperature of incubation.*

If the prefeeding period (i.e. the period between hatching and feeding or moulting and feeding) is sufficiently long (see § 3 B (c)) and is spent at or above 18° C., then approximately 80% of bugs which feed in the laboratory will moult at all temperatures between and including 15 and 23° C.; at 13° C. moulting of first instars ceases and at 13·7° C. only 7% of fed first instars moult. The threshold for moulting for the other instars is probably the same as for the first instar. Table 16 gives the data.

Table 16. *Percentage of larvae of different instars which moulted at 15, 18 and 23° C. after one feed and after prefeeding periods at 18 and 23° C. Percentage moulted is calculated from the number which were offered blood: there is very little difference if percentage is calculated from actual numbers which fed. In each case first instar's prefeeding period was spent at 23° C. Bugs fed on rabbit in darkness at 23° C.*

| Instar | 23° C. | | 18° C. | | 23° C. | |
|------------------|-----------|-------------------|-----------|-------------------|-----------|-------------------|
| | % moulted | No. offered blood | % moulted | No. offered blood | % moulted | No. offered blood |
| I | 75 | 100 | 66·2 | 263 | 80·9 | 188 |
| II | 83 | 100 | 85·3 | 170 | 87·7 | 146 |
| III | 72 | 100 | 89·4 | 142 | 90·2 | 123 |
| IV | 81 | 100 | 93·4 | 122 | 72·2 | 108 |
| V | 83·9 | 93 | 72·8 | 114 | 93·3 | 75 |
| Means and totals | 78·9 | 493 | 79·3 | 811 | 84·2 | 640 |

(b) *The effect of the temperature during the prefeeding period.*

The situation described in the preceding subsection is altered radically if prefeeding periods are spent at temperatures at and below 15° C. (59° F.). For although as Table 6 shows, a high proportion of bugs will gorge at 15° C., very

few will moult (Table 17). First instars appear to be particularly susceptible to low temperatures, and after a week at 13–15° C. are rarely capable even of feeding. I have observed this many times, and the problem needs systematic study. These are recently discovered facts and, apart from having to discard many experiments in which the proportion moulting was used as a guide to the proportions feeding, it has not been possible to investigate the phenomenon fully or to assess its true significance in the life of the bug. For we do not know if the inability to moult, although bugs may be gorged, is a permanent defect or if it is a temporary condition, eliminated by a sojourn at a higher temperature. Even if repeated feeds are necessary, this will delay development and seriously upset estimations based on the belief that low temperatures

Table 17. *The effect of the temperature during the prefeeding period on ability of C. lectularius to moult. The conditions after feeding were 15 ± 1.0° C. and 90% R.H. in each case. Bugs fed on rabbit at 23° C. in darkness. Percentage moult is calculated from numbers offered blood: if calculated from numbers fed the difference is very slight. In each case, both with prefeeding periods at 15 and at 23° C., the majority of bugs gorged with blood: for actual figures see Table 6. The first instar spent prefeeding period in 23° C. in both experiments*

| Instar | 15° C. 90% R.H. 6–18 days | | 23° C. 90% R.H. 3–6 days | |
|--|---------------------------------|----------------------|--------------------------------|----------------------|
| | % moulted | No. offered blood | % moulted | No. offered blood |
| I | 75 | 100 | 75 | 100 |
| II | 27.6 | 58 | 83 | 100 |
| III | 16.7 | 78 | 72 | 100 |
| IV | 15.9 | 63 | 81 | 100 |
| V | 10.1 | 69 | 83.9 | 93 |
| Means and totals (excluding first instar) | 17.2 | 268 | 79.9 | 393 |

ceased to have an effect soon after bugs were moved to higher ones. We have therefore to face the possibility of this phenomenon occurring in nature, for winter temperatures drop well below 15° C. in Britain. Then, either a large proportion of the immature stages in a population will be unable to develop into adults or they may do so slowly, perhaps after additional feeds, and at a rate which only future experiments can decide.

Before the discovery of this 'diapause' in *C. lectularius* it was assumed that a temperature of 15° C. merely slowed down development—as with bugs kept at 15° C. after a prefeeding period at 23° C.—and that development and activity were assumed normally when the temperature rose. Thus statements that bed-bugs do not hibernate in the true sense of the word (e.g. Jones, 1930) may not be strictly true.

E. Mortality during development

In laboratory cultures which are fed regularly in tubes on rabbit a slight mortality, apparently due to defects in the insects, occurs. This is manifested by a rupturing of the alimentary tract from which the insect does not recover:

this phenomenon is precisely the same as that described by Wigglesworth (1931) and Kemper (1932). The rupturing of the gut during development, however, occurs a day or two after feeding and is not the result of starvation (see Wigglesworth, 1931).

Table 18 gives data for the percentage mortality due to this cause when insects are bred at 29° C.

Table 18. *Mortality among fed larvae during development at 29° C., 75 % R.H., due to rupture of alimentary tract. One feed per instar. First instar with 7 days', all others with 2 days' prefeeding period at 29° C., 75 % R.H.*

| | Instars | | | | | Mean % ruptured during development |
|----------------|---------|------|------|------|------|--|
| | I | II | III | IV | V | |
| Nos. | 499 | 520 | 439 | 476 | 634 | — |
| % with rupture | 0 | 3.46 | 9.57 | 7.98 | 9.46 | 6.1 |

4. THE EGG PRODUCTION OF ADULTS

A. *Egg production from a single blood-meal*

(a) *The weight of the unfed female and of the blood-meal.*

It is necessary to consider these important variables, not so much for their importance in ecology, but since their effect must be known for satisfactory laboratory work in other directions. The force of this is seen in the section on the effect of temperature and humidity on egg production from a single meal (p. 380) where allowance must be made for the influence of body weight and of blood-meal before the effect of humidity on egg production can be assessed.

Consider first bugs which are allowed to feed to repletion.

Bugs fed to repletion. The conditions of the experiment were as follows: Male and female fifth instars were fed and put singly into tubes. On moulting into adults they were kept for 5–6 days at 23° C., 75 % R.H., to allow the midgut to become almost empty of the meal taken before the previous moult. Bugs were then weighed individually on a torsion balance and then fed, on rabbit, to repletion. They were immediately reweighed and paired off, a male and a female in a 2 × 1 in. tube. They remained together there, at 23° C., 75 % R.H., till no more eggs from that one meal were laid. The second meal was offered about 20 days after the first meal, but the males were this time removed immediately after feeding. The weight of the second meal was also determined.

Thus we have three interrelated variables:

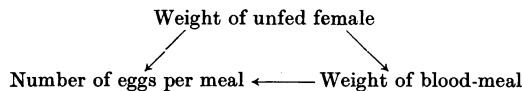

The number of eggs is positively correlated with (1) weight of unfed female, (2) weight of blood-meal (see also Titschack, 1930). The weight of the blood-meal may be positively correlated with the weight of the unfed female.

Let us consider the correlations between these three variables for the first and for the second meals taken by the adults after moulting (Tables 19–21; also Fig. 13).

It can be seen from Table 20 that no correlation would be detected between the weights of the unfed bugs and the first blood-meal: but the number of eggs laid is slightly correlated both with the weights of the unfed bug and the blood-meal.

Table 19. *Mean and standard deviations of the weight of the unfed female, X, weight of blood ingested, Y, and number of eggs per female per blood-meal, Z. Data with which complete and partial correlation coefficients in Tables 20 and 21 are associated. 23° C., 75 % R.H. All weights in mgms*

| | X | s.d. | Y | s.d. | Z | s.d. | No. of bugs |
|----------------------|------|--------|-------|--------|-------|--------|-------------|
| First meal as adult | 4.98 | 0.9977 | 7.60 | 1.7883 | 8.87 | 3.4842 | 135 |
| Second meal as adult | 4.59 | 1.0256 | 10.39 | 2.0087 | 6.27. | 3.0602 | 142 |

Table 20. *Correlation coefficients r, and their standard deviations between X, weight of unfed female; Y, weight of blood-meal; Z, number of eggs per female per blood-meal. Bugs fed to repletion on rabbit and kept at 23° C., 75 % R.H., from meal until end of oviposition. All weights in mgms*

First meal 5–6 days after moulting—males present continuously.

Second meal about 20 days after first meal—males removed after second meal.

| Correlation between | r | s.e. | Sig. test |
|------------------------|--------|-------|-----------|
| First meal: 135 pairs | | | |
| X : Y | 0.0893 | 0.085 | Not sig. |
| Y : Z | 0.3907 | 0.073 | Sig. |
| X : Z | 0.3620 | 0.075 | Sig. |
| Second meal: 142 pairs | | | |
| X : Y | 0.4433 | 0.067 | Sig. |
| Y : Z | 0.6387 | 0.050 | Sig. |
| X : Z | 0.3036 | 0.076 | Sig. |

Table 21. *Partial correlation coefficients and standard errors between X, weight of unfed female; Y, weight of blood-meal; Z, number of eggs per female per blood-meal. $r_{ZX, Y}$ = correlation between X and Z if Y is constant. Conditions as in Table 20*

| | $r_{ZX, Y}$ | s.e. | $r_{ZY, X}$ | s.e. |
|-------------|-------------|-------|-------------|-------|
| First meal | 0.3568 | 0.075 | 0.3859 | 0.073 |
| Second meal | 0.0296 | 0.084 | 0.5903 | 0.055 |

With the second meal the correlation between weights of bug and blood-meal is slight but significant: larger bugs take larger meals. The number of eggs is again correlated with the weights of both bug and meal.

With the first meal the number of eggs is obviously more directly correlated with the weight of the unfed female than for the second meal. For we notice that larger females took larger meals the second time: and the larger number of eggs may therefore have been laid only because the larger females took more blood.

No satisfactory explanation is offered to account for the lack of correlation between the weights of unfed females and the first blood-meals or for its existence at the second meal.

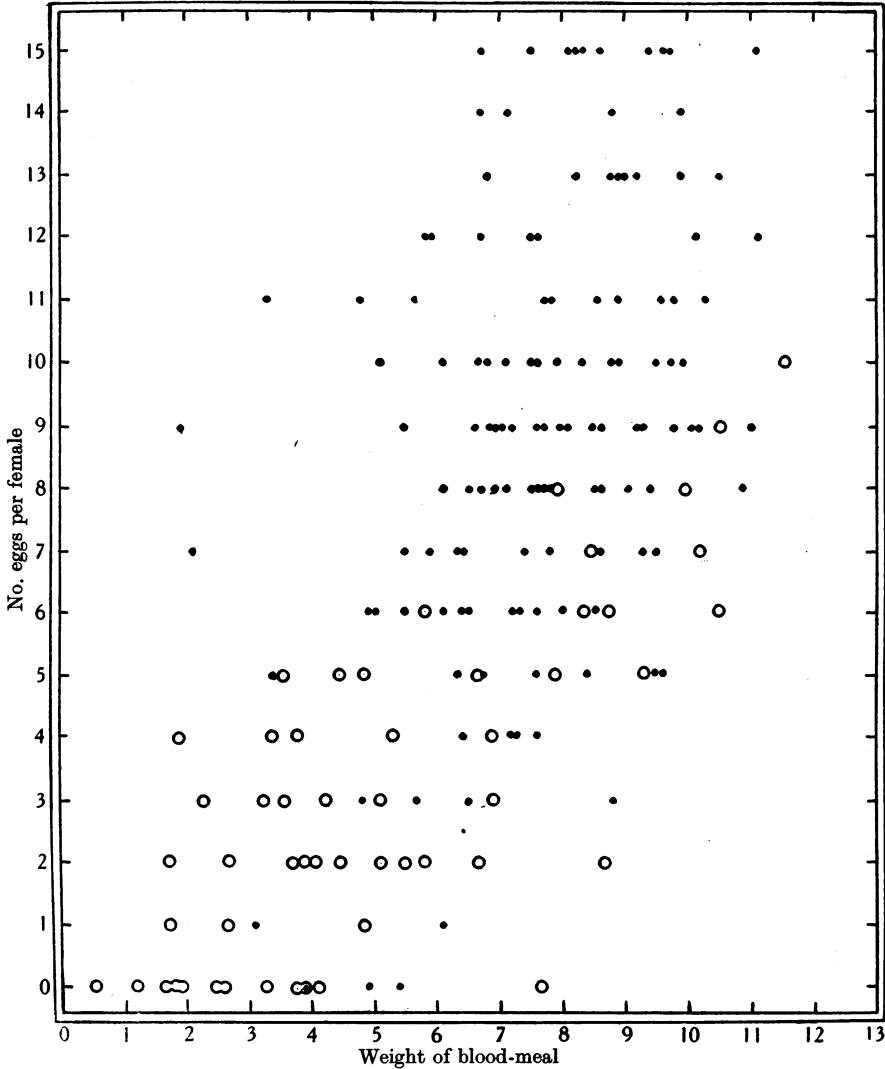

Fig. 13. The effect of weight of blood-meal on egg production at 23° C. from a single meal. Data in Tables 19-23. •, complete meals; ○, partial meals.

Let us now study the partial correlation coefficients (Table 21). These show the strength of the correlation between two variables when the amount of correlation of one of them with a third variable is eliminated.

It is evident from Table 20 that egg production is slightly correlated with both weight of unfed female and with weight of blood-meal, and from Table 21

it is evident that if the correlation of egg number and weight of the blood-meal is eliminated ($r_{ZX.Y}$), then there is no correlation between egg number and weight of unfed female with the second meal.

But for experimental purposes we ask: Is it necessary to know both the weight of unfed females and of blood-meals before the egg production can be accurately expressed or before the effect of variation of these variables can be assessed in other experiments? For if egg production is more strongly correlated with one than with another, knowledge of variables with the stronger correlation may be all that is necessary in order to allow for the effects of both.

Now if both weight of unfed female (X) and weight of blood-meal (Y) were correlated with egg number (Z)

$$Z = X + bY + c. \quad (1)$$

The partial standard deviation of Z , ($\sigma_{Z.XY}$), when X and Y are thus accounted for, can also be determined, and it gives us a measure of the accuracy of the above formula.

If, however, we take but one of the two independent variables above, we may estimate Z with it thus:

$$\text{either} \quad Z = d.X + K, \quad (2)$$

$$\text{or} \quad Z = d_1.Y + K_1; \quad (3)$$

we can also obtain standard deviations, $\sigma_{Z.X}$ and $\sigma_{Z.Y}$ of Z .

If $\sigma_{Z.X}$ and $\sigma_{Z.Y}$ are nearly the same it is clear that Z could be estimated with almost equal accuracy by the use of *either* X or Y . Moreover, if $\sigma_{Z.X}$ and $\sigma_{Z.XY}$ are the same then Z can be as accurately expressed in terms of X alone as in terms of both X and Y .

Table 22. *The number of eggs per female per blood-meal, Z, at 23° C., 75 % R.H., and its partial standard deviation in terms of the weight of the unfed female, X, or of the blood-meal in milligrams, Y. Z = dX + K, where d and K are constants and Z = d₁Y + K₁*

| Z | Partial s.d. |
|------------------------------|--------------|
| First meal as adult | |
| 1.3642 X + 2.4718 | 3.2478 |
| 0.8612 Y + 2.9881 | 3.2072 |
| 1.1517 X + 0.7038 Y - 2.1622 | 2.9962 |
| Second meal | |
| 0.9058 X + 2.1105 | 2.9158 |
| 0.9731 Y - 3.8383 | 2.3546 |
| 0.0758 X + 0.9559 Y - 4.0079 | 2.3536 |

Table 22 gives equations in which Z , the number of eggs produced, is expressed in terms of the weight of the unfed female, X , or of the weight of the blood-meal, Y , or of both X and Y . The partial standard deviations of Z expressed in each of these ways are also given.

With the first meal it is clear that, although the more accurate expression involves both X and Y ($\sigma_{Z.XY}$ is the smallest of the three), there is very little

advantage to be gained by its use. In fact all three standard deviations are so close that expressions which make use of either X or Y alone are equally accurate.

With the second meal a slightly more accurate expression of Z is obtained if it is expressed in terms of the weight of the blood-meal than if with the weight of the unfed female. But no more accuracy is gained by expressing Z in terms of both X and Y . And this is true in spite of the existence of a correlation between both weight of the female and the amount of blood it ingests.

Thus, it seems, that for practical purposes we require to know only the weight of the unfed female or perhaps better still the amount of blood ingested in order to allow for the effect of these variables on egg production. The weight of the unfed bug may in part be due to varying quantities of blood remaining behind after its moult from the fifth instar.

Table 23. *Data at 23° C., 75 % R.H. Males and females kept in pairs for 24 hr. at 28° C. and males then removed. Females given small feeds on rabbit after mating. (First feed as adult)*

| | Weight of unfed ♀ mg. X | Weight of blood-meal mg. Y | No. of eggs laid Z | No. of bugs |
|------|---------------------------------|------------------------------------|-------------------------|-------------|
| Mean | 3.5467 | 5.0764 | 2.8889 | 63 |
| S.D. | 0.6770 | 2.6169 | 2.5015 | |

Correlation coefficients and standard errors

$$\begin{array}{ll}
 r_{XY} = 0.0851 \pm 0.1251, & r_{ZX.Y} = 0.2985 \pm 0.1148, \\
 r_{ZX} = 0.2523 \pm 0.1180, & r_{ZY.X} = 0.7876 \pm 0.0478, \\
 r_{YZ} = 0.7808 \pm 0.0492, &
 \end{array}$$

Probably below about 1 mg. of blood bugs would lay no eggs at all. But it needs only a very small meal to enable a few bugs to produce considerable numbers of eggs under laboratory conditions, as Fig. 13 shows.

Partial feeds. When bugs are purposely given small meals the size of the meal is, of course, not correlated with the size of the bug ($r = 0.0851$, s.e. = ± 0.1251). But the number of eggs laid is still slightly correlated with the weight of the unfed female (r_{ZX} and $r_{ZX.Y}$), and highly correlated with the size of the meal (r_{YZ} and $r_{ZY.X}$) (Table 23 and Fig. 13). The small number of eggs produced (Table 23 and Fig. 13) may possibly be influenced, too, by the small size of the females.

The correlation of fecundity with body size may be of considerable local significance. For body size, as measured by head width, is strongly correlated with latitude (Johnson, 1939) and possibly also with the numbers of X -chromosomes in the nucleus (see p. 421 and Darlington, 1939).

(b) *The effect of temperature and atmospheric humidity.*

Temperature. Males and females were allowed to remain at 23° C. for a few days after moulting. They were then fed in pairs on rabbit and replaced at 23° C. After a further 24 hr., during which copulation almost invariably

occurred, the bugs were placed at various constant temperatures and humidities for ovarian development and oviposition to proceed.

Table 24 gives the data. The threshold temperature for ovarian development followed by oviposition is approximately 13° C. (55.4° F.). The threshold for oviposition alone is, however, lower than 13° C. For if fertilized females are kept at 23° C. till oviposition commences, they can be placed at temperatures of 10.0 ± 0.5° C., and occasionally an egg will be laid during the following days. The actual ovipositional threshold is probably between 8 and 9° C. (46.4 and 48.2° F.): for if ovarian development proceeded at about 15–18° C. possibly a slight 'acclimatization' might allow activity for oviposition at this low temperature.

The effect of temperature on the numbers of eggs which bugs lay is not so clear-cut as the effect of temperature on some other vital processes. There is, as Cragg (1923) also noticed, a considerable variation between the egg output of individual females: this may be due to differences in size, nourishment during development, and the size of the blood-meal from which eggs are laid.

Table 24. *Egg production after first feed as adult at 13, 18 and 23° C., 10 and 90 % R.H. All bugs bred at 23° C. on rabbit*

| ° C. | % R.H. | Mean weight of unfed ♀ mg. | Mean weight of blood-meal mg. | Mean no. of eggs and S.D. | No. of bugs | Sig. test between egg nos. |
|------|--------|----------------------------|-------------------------------|---------------------------|-------------|----------------------------|
| 13 | 10 | 4.94 | 8.69 | 3.35 : 1.15 | 20 | Sig. |
| | 90 | 4.75 | 9.12 | 1.94 : 1.00 | 17 | |
| 18 | 10 | 4.82 | 7.82 | 6.14 : 2.20 | 22 | Sig. |
| | 90 | 4.43 | 9.02 | 3.85 : 1.39 | 20 | |
| 23 | 10 | 4.09 | 6.98 | 6.05 : 2.33 | 22 | Not sig. |
| | 90 | 4.27 | 8.09 | 5.08 : 2.08 | 24 | |

Humidity evidently has a slight effect, and the degree of activity of the females while in the experiment may also introduce variation in egg output. The part played by the male has been considered important by Cragg who thought a well-nourished male caused a female to produce more fertile eggs than an under-nourished one. This is possibly true, although Cragg's samples were much too small for this to be definitely established. Copulation in experiments should, moreover, always take place in the first 24 hr. after feeding so that the blood-meal can be used to the maximum extent for egg production.

Throughout all my experiments I have been careful to breed the adults subsequently used in experiments under standard conditions—one feed an instar, at 23° C. and 75 % R.H., with prefeeding periods of 2–4 days. Rabbit has almost always been used as host: it is stated where otherwise.

Yet as Table 24 shows, the egg production at 10 % R.H. and 23 and 18° C. is almost precisely the same for the single meal; this is not so at 90 % R.H. There is of course a big difference in the time taken to lay the full complement of eggs at the two temperatures. And in one experiment at 23° C., 75 % R.H., with the bugs reared on man the mean egg number per female per meal was 11.9, nearly twice the usual amount at this temperature. And similar

differences will be noticed between the data in Tables 24 and 25 where at 23° C. and 90% R.H. the mean number of eggs laid was 5.08 and 9.40: the conditions, moreover, were similar and so were the weights of the bugs and the blood-meals. Records in the literature of numbers of eggs laid also show considerable variation.

If bugs are bred at 28° C. with two feeds per week, the adults are large and are able to lay appreciable numbers of eggs before they have fed as adults, presumably on account of the considerable amount of blood carried over in the midgut when the fifth nymph moults.

The amount of blood in the gut before the first feed as adult will then, presumably, greatly influence the number of eggs produced per feed. For this reason the duration of the prefeeding period of the adult and the temperature at which it is passed should be standardized and stated in experiments. An error may also be introduced by considering only the number of eggs laid, and not including also those which may be retained within the female after oviposition has finished. In the few bugs I have dissected there have often been

Table 25. *The effect of atmospheric humidity on egg production at 23° C. after first feed as adult. Prefeeding period, 5 days at 23° C., 75% R.H. Males and females continuously together*

| R.H. % | Mean weight of unfed ♀ and S.D. mg. | Mean weight of blood-meal and S.D. mg. | Mean no. of eggs laid and S.D. | No. of bugs | Sig. test on egg nos. |
|-----------|---|--|--------------------------------------|----------------|--------------------------|
| 10 | 4.1022 : 0.8599 | 6.3217 : 1.8070 | 5.7826 : 2.7656 | 23 | } Sig. |
| 75 | 3.8106 : 0.5302 | 8.0131 : 1.4301 | 6.3125 : 2.8662 | 16 | |
| 90 | 4.1285 : 0.2333 | 8.2095 : 1.7181 | 9.40 : 4.9639 | 20 | |

one or two such eggs remaining within the oviducts. It may, in future experiments, be better to use the egg production of first *and* second meals as a measure of fecundity, since, as Figs. 16 and 17 show, the maximum number of eggs per meal is not produced with the first feed.

Humidity. Bugs were kept at a constant temperature of 23° C., but at three different relative humidities. The data are given in Table 25, where only the first meal as adult is considered. These data are best considered in conjunction with the effect of the weight of the blood-meal and of the unfed female on egg production. For this purpose it is convenient to consult Fig. 13.

Then bearing in mind the slight effect of the weight of the unfed female and of the weight of the blood-meal, the evidence is not sufficiently strong to maintain that the differences in the numbers of eggs laid are due to humidity differences.

From the sections on temperature and egg production (Table 24) and in spite of the effect of variation in weight of unfed females and of blood-meal, the evidence suggests that at 90% R.H. rather fewer eggs are produced than at 10% R.H. This is also supported by results in subsection B on repeated feeding (Fig. 14).

It can be seen, however, that there is no proof that humidity has any serious effect on egg production, and in Fig. 14 it may well be that the effect is indirect, in that larger meals are taken if bugs have been kept at a lower humidity. But this would not apply in Table 25 for the single meals, where prefeeding periods were all spent at the same humidity.

The problem of egg production in relation to temperature and humidity is not simple, since other variables are difficult to control and their effects, which are considerable, are not easy to estimate accurately. Nevertheless, if humidity has any direct effect on egg production it seems unlikely that it will

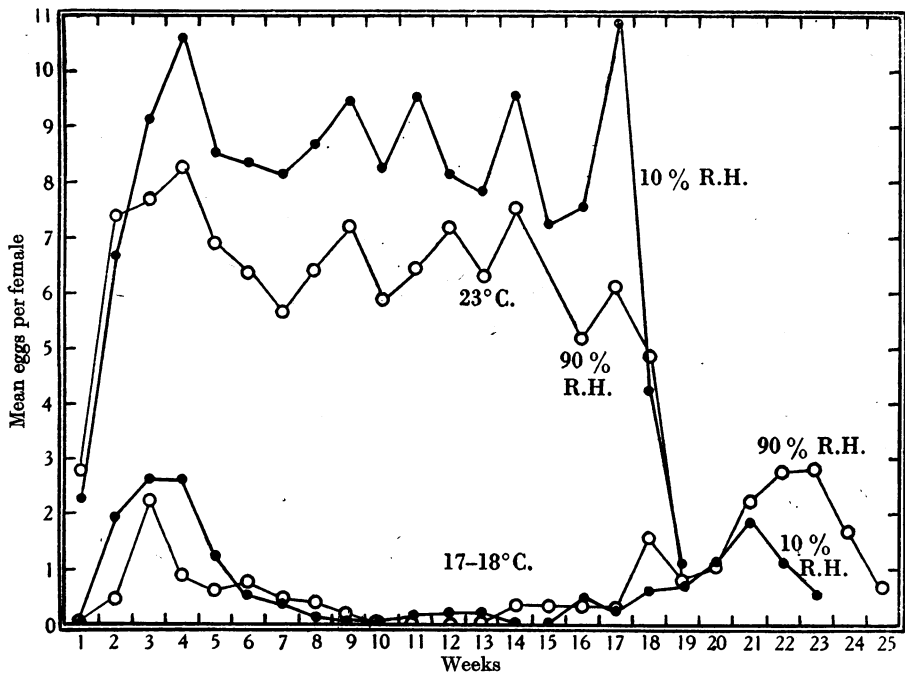

Fig. 14. Mean normal eggs per female per week at 23 and 17-18° C. when males and females cohabit and are fed once a week. ● = 10% R.H.; ○ = 90% R.H. Data in Tables 26 and 27.

be of very great relative importance in the growth of populations. The influence of atmospheric humidity on the feeding cycle is, however, quite unknown, and in affecting this may also affect egg production (pp. 383-4).

(c) *The blood of different hosts.*

The effect of the blood of different hosts on egg production was discussed in a previous paper (Johnson, 1937), and only a brief summary need be given here. Three kinds of host were used—man, mouse and fowl—and it was found that for the first meal as adults females which had been bred on mouse laid the greatest number of eggs and those which had been bred on man laid the least. The important factor, weight of blood-meal, was clearly not responsible

for these differences, since practically the same weight of blood was taken from each host. The egg numbers were, however, correlated with the weights of the unfed females which varied with the different hosts. When the effects of this factor had been eliminated there was nothing to show that differences existed between fowl-fed and man-fed bugs, although bugs fed on mouse remained the slightly better egg producers.

Since most of the experiments described in this report were made with rabbit as host, and the picture in Part II is based on these, it is reasonable to ask if bugs fed on rabbit differ in their egg-producing capacity from those fed on man. The experiments which were designed to answer this question repeatedly miscarried, and the existing results do not take the body weight of the females or the weight of the blood-meal into account. But these results do not suggest that differences due to hosts would be very great, and the differences in weight of the females or of their blood-meals were probably responsible for the variations in egg production which occurred. At 23° C. rabbit-fed bugs produced 9.61 and 6.62 eggs per female for the first feed, at 90 and 10% R.H. respectively, while bugs fed on man laid 7.0 and 8.86 eggs under the same conditions.

It will be gathered from the foregoing description of the many factors affecting fecundity that much variation exists between individual bugs and between different batches even under apparently the same experimental conditions, and this, together with the much more important but unpredictable factor of feeding frequency, is likely to have more effect on fecundity in nature or in theoretical calculations (Part II) than differences in host.

B. *Egg production in the laboratory with repeated opportunities to feed:
when males and females cohabit*

(a) *The effect of different intervals between meals.*

In nature, bugs will feed at certain intervals depending on environmental conditions. In the laboratory they can be given an opportunity to feed at any time. It is possible to induce bugs to feed even more than twice a week if they are kept at 23° C. (73.4° F.), which is a temperature commonly prevailing inside houses in summer in England.

Suppose a female bug is fed and, without another meal, it oviposits until the egg supply is exhausted: if fed again, a latent period of 5–6 days (the same length as the preovipositional period after the first feed as adult (p. 359)) follows before oviposition is resumed. The graph for egg production is a series of peaks and troughs with about a 12-day cycle and about 6–10 eggs per cycle at 23° C. (Fig. 15A).

If bugs kept at 23° C. are fed at 7-day intervals this latent period is reduced to 1–3 days, and with bi-weekly feeds it is quite obliterated (Fig. 15B, C). The net result of increased frequency of feeding is to increase the general level of egg production and to shorten or eliminate the latent period. In a population

where individual egg cycles would overlap even with relatively infrequent feeds this increase is the important thing. The actual increase in egg production from a population of bugs fed once and twice a week for a considerable period can be seen in Tables 30 and 31 and Figs. 16 and 17.

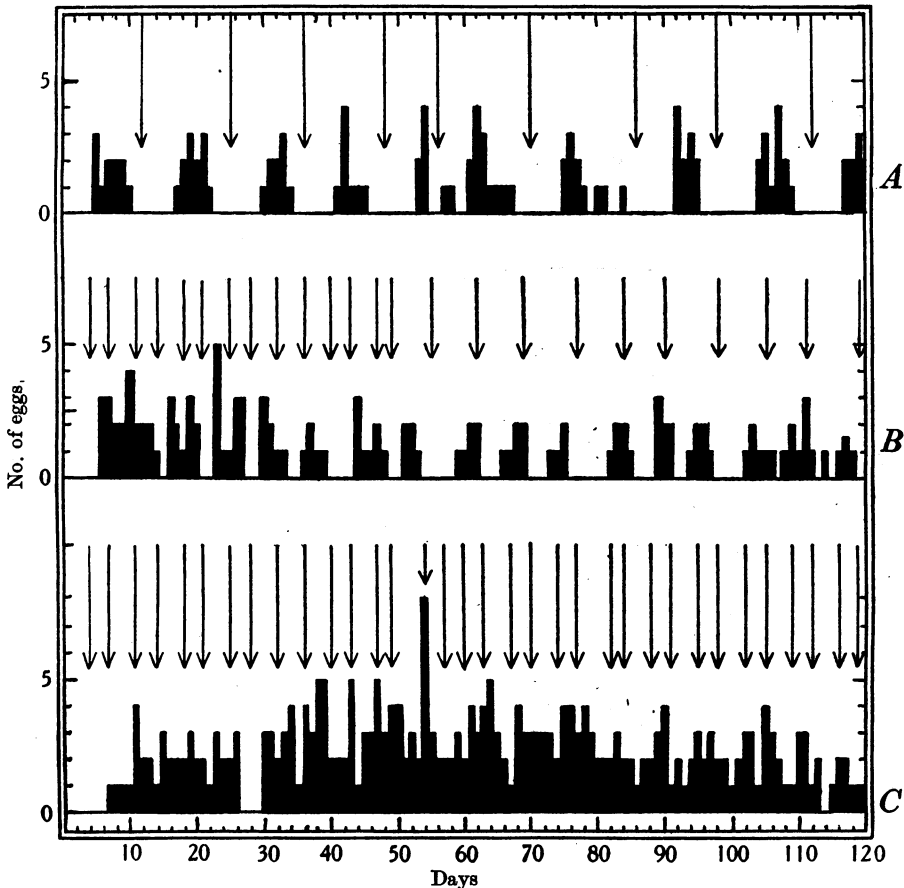

Fig. 15. Egg production at 23° C. of individual females (each kept with a male) fed on rabbit at varying intervals. Arrows indicate when fed. *A.* Fed on second or third day after cessation of oviposition (i.e. at 8-16-day intervals). *B.* Fed at 3- and 4-day intervals and later at 7-day intervals. *C.* Fed at 3- and 4-day intervals continuously.

Obviously it is important to know the conditions which govern feeding frequency in nature and how they occur. Temperature, humidity and light appear to be the most important factors and the effects of temperature may be expected to be two-fold.

(i) Increase of temperature increases the number of eggs per unit weight of blood-meal, at any rate near the threshold for ovarian development and oviposition.

(ii) Increase of temperature increases the number of meals ingested.

(b) *The effects of temperature and atmospheric humidity.*

Experiments have been made at 13, 18 and 23° C. (55.4, 64.4 and 73.4° F.) and at 10 and 90 % R.H. at each temperature. These temperature conditions may be regarded as equivalent to spring and autumn and to summer conditions in English houses. 13° C. is, moreover, the threshold for ovarian development with oviposition.

Conditions of this experiment. Five male and five female adults were kept together in 2 × 1 in. tubes—rather a confined space, but not unnatural for resting bugs—and offered a blood-meal from rabbit at 23° C. once a week. Bugs kept at 23° C. usually fed to repletion once a week. But at 17–18° C. where digestion is slow, this usually did not occur; in fact it was often difficult to tell whether the fullness of the bug was due to the previous feed or to a new one. The same applied to bugs kept at 13° C., but was even more marked, and certainly there were often long periods when no bugs fed at all. Bugs from 18 and 13° C. would often sit at the ends of the tubes away from the rabbit's ear: and this suggested that a migration down the temperature gradient occurred.

At 23° C. the mean weekly egg production reaches its maximum about a month after the experiment started (i.e. after feeding and mating) and then fluctuated about a mean value slightly below the maximum. This continued for 13 weeks after the maximum was attained. It then began to fall and the experiment unfortunately had to be finished. The maximum number of eggs per female per week was slightly lower with bugs kept at 90 % R.H. than for those kept at 10 % R.H. (Fig. 14). No check was kept on the amounts of blood the females ingested, but the mean weights of the unfed females were the same (3.76 and 3.84 mg. for 10 and 90 % R.H.). It is worth noticing, too, that the fluctuations in numbers of eggs produced appear to be quite regular for both humidities and thus could not have been due to fluctuations in environmental temperature which was constant to 0.2° C. A similar cycle is evident at 17–18° C. but with a longer interval.

At 17–18° C. the maximum mean egg output per female per week was again reached after about a month from feeding and mating—the same as for 23° C. (within an error of ± 0.5 week since inspections were made once a week). Like the bugs at 23° C. the mean weekly egg production then fell rapidly, but unlike them it did not recover quickly and for many weeks the majority of females failed to oviposit. After the sixteenth week, however, the egg output increased again to a second maximum approximately 18–20 weeks after the first maximum. The experiment was ended as the egg production again declined (Tables 26 and 27 and Fig. 14).

The mean periods for the first cycle of egg production and for the periods during which no eggs were laid for bugs kept at 17–18° C., and 10 and 90 % R.H. appears in Table 28. Both at 10 and 90 % R.H. the period of abeyance is longer than the first period of oviposition.

At 13° C. few eggs were laid. The maximum egg production per week per female was reached between 4 and 6 weeks after the experiment started. No

Table 26. *Weekly egg production at 23° C. (73.4° F.) and at 10 and 90 % R.H. Five pairs of females and males per tube offered blood-meal from rabbit at 23° C. once a week. No. of females diminishes due to deaths. The experiment was terminated before all the females had died*

| Weeks | 10% R.H. Mean weekly egg output per ♀ | | | 90% R.H. Mean weekly egg output per ♀ | | |
|-----------------------------------|--|---------|-----------|--|---------|-----------|
| | Normal | Sterile | No. of ♀♀ | Normal | Sterile | No. of ♀♀ |
| 1 | 2.27 | 0.05 | 56 | 2.76 | 0 | 54 |
| 2 | 6.67 | 0.04 | 55 | 7.35 | 0.04 | 54 |
| 3 | 9.11 | 0.13 | 54 | 7.69 | 0 | 54 |
| 4 | 10.60 | 0.10 | 50 | 8.29 | 0.02 | 51 |
| 5 | 8.51 | 0.04 | 49 | 6.92 | 0 | 50 |
| 6 | 8.39 | 0.02 | 46 | 6.42 | 0 | 45 |
| 7 | 8.13 | 0 | 45 | 5.67 | 0 | 42 |
| 8 | 8.58 | 0.09 | 43 | 6.41 | 0.08 | 41 |
| 9 | 9.45 | 0.08 | 40 | 7.20 | 0.05 | 40 |
| 10 | 8.23 | 0.05 | 39 | 5.89 | 0.14 | 38 |
| 11 | 9.55 | 0.11 | 38 | 6.49 | 0.21 | 37 |
| 12 | 8.17 | 0.41 | 36 | 7.17 | 0.19 | 36 |
| 13 | 7.85 | 0.15 | 33 | 6.33 | 0.09 | 36 |
| 14 | 9.58 | 0.07 | 26 | 7.53 | 0.25 | 32 |
| 15 | 7.25 | 0.04 | 24 | 7.29 | 0.13 | 31 |
| 16 | 7.55 | 0.15 | 20 | 5.20 | 0.13 | 30 |
| 17 | 10.89 | 0.28 | 18 | 6.14 | 0.15 | 28 |
| 18 | 4.28 | 0.05 | 18 | 4.85 | 0.03 | 26 |
| 19 | 1.12 | 0 | 17 | 0.80 | 0.16 | 25 |
| Original mean wt. of unfed ♀♀ mg. | 3.76 | | | 3.84 | | |

Table 27. *Weekly egg production at 17-18° C. (62.6-64.4° F.) and at 10 and 90 % R.H. Five pairs of females and males per tube offered blood-meal from rabbit at 23° C. once a week. No. of females diminishes due to deaths. The experiment was terminated before all the females had died*

| Weeks | 10% R.H. Mean weekly egg output per ♀ | | | 90% R.H. Mean weekly egg output per ♀ | | |
|-----------------------------------|--|---------|-----------|--|---------|-----------|
| | Normal | Sterile | No. of ♀♀ | Normal | Sterile | No. of ♀♀ |
| 1 | 0 | 0 | 58 | 0 | 0 | 52 |
| 2 | 1.95 | 0.02 | 57 | 0.44 | 0 | 52 |
| 3 | 2.63 | 0.04 | 57 | 2.25 | 0 | 52 |
| 4 | 2.66 | 0.08 | 56 | 0.90 | 0 | 52 |
| 5 | 1.23 | 0 | 55 | 0.64 | 0 | 52 |
| 6 | 0.55 | 0.04 | 55 | 0.79 | 0.02 | 52 |
| 7 | 0.38 | 0.02 | 55 | 0.47 | 0 | 49 |
| 8 | 0.13 | 0 | 55 | 0.41 | 0 | 46 |
| 9 | 0 | 0 | 52 | 0.20 | 0 | 45 |
| 10 | 0.06 | 0 | 51 | 0.02 | 0 | 44 |
| 11 | 0.18 | 0 | 51 | 0 | 0.02 | 43 |
| 12 | 0.25 | 0.02 | 49 | 0 | 0 | 42 |
| 13 | 0.25 | 0 | 48 | 0 | 0 | 40 |
| 14 | 0 | 0 | 48 | 0.32 | 0 | 38 |
| 15 | 0.06 | 0.02 | 47 | 0.32 | 0 | 38 |
| 16 | 0.51 | 0 | 45 | 0.32 | 0 | 38 |
| 17 | 0.29 | 0 | 45 | 0.32 | 0 | 38 |
| 18 | 0.62 | 0 | 44 | 1.58 | 0.08 | 38 |
| 19 | 0.73 | 0.02 | 44 | 0.75 | 0 | 36 |
| 20 | 1.16 | 0.06 | 44 | 1.09 | 0.03 | 35 |
| 21 | 1.84 | 0.06 | 44 | 2.23 | 0.03 | 31 |
| 22 | 1.14 | 0 | 44 | 2.77 | 0.13 | 31 |
| 23 | 0.59 | 0.02 | 44 | 2.82 | 0.07 | 28 |
| 24 | 0 | 0 | 0 | 1.70 | 0.07 | 27 |
| 25 | 0 | 0 | 0 | 0.07 | 0 | 27 |
| Original mean wt. of unfed ♀♀ mg. | | 3.65 | | | 3.45 | |

fertile eggs were laid after the tenth week. The experiment was discontinued after about 20 weeks, no more eggs having been laid: it is, however, quite probable that eggs would be laid again after a latent period somewhat longer than at 18° C. Data for 13° C. are to be found in Table 29.

It cannot be said how much the period during which oviposition does not occur at 17–18° C. is due to the direct effect of temperature on ovarian activity or to sluggish feeding of the insects, or whether the fluctuations in egg production at 23° C. are due to irregular feeding or to an inherent rhythm of activity of the ovaries. An attempt was made to estimate the numbers of bugs which gorged, half-fed or failed to feed after each weekly opportunity.

Table 28. *Mean periods for egg production and for suspension of oviposition at 17–18° C., 10 and 90% R.H. Numbers of eggs and bugs in Table 27*

| | 10% | 90% |
|---|-------------|--------------|
| Mean and s.d. in weeks for first period of oviposition | 6.09 : 1.09 | 5.45 : 2.44 |
| Mean and s.d. in weeks for period of suspension of oviposition, between first and second ovipositional cycles | 8.00 : 3.66 | 10.64 : 2.48 |

Table 29. *Weekly egg production at 13° C. (55.4° F.), and at 10 and 90% R.H. Five pairs of females and males per tube offered blood-meal from rabbit at 23° C. once a week*

| Weeks | 10% R.H. Mean weekly egg output per ♀ | | | 90% R.H. Mean weekly egg output per ♀ | | |
|-------|--|---------|-----------|--|---------|-----------|
| | Normal | Sterile | No. of ♀♀ | Normal | Sterile | No. of ♀♀ |
| 1 | 0 | 0 | 55 | 0 | 0 | 54 |
| 2 | 0 | 0 | 54 | 0 | 0 | 54 |
| 3 | 0 | 0 | 54 | 0 | 0 | 54 |
| 4 | 0 | 0 | 54 | 0.07 | 0 | 54 |
| 5 | 0 | 0 | 52 | 0.24 | 0 | 54 |
| 6 | 0 | 0 | 52 | 0.04 | 0 | 54 |
| 7 | 0.25 | 0 | 52 | 0 | 0.02 | 54 |
| 8 | 0.06 | 0.06 | 52 | 0 | 0 | 0 |
| 9 | 0.04 | 0 | 52 | 0 | 0 | 0 |
| 10 | 0 | 0 | 52 | 0 | 0 | 0 |
| 11 | 0.02 | 0 | 52 | 0 | 0 | 0 |
| 12–20 | 0 | 0 | 51 | 0 | 0 | 50 |

At 23° C. all bugs usually gorged once a week. But digestion is quite slow at 18° C., and in many cases it was very difficult to tell if the blood within a bug was a fresh meal or the remains from the week before. It can be said definitely, however, that most of the bugs possessed considerable quantities of blood in the midgut during most of the period when no eggs were laid, and that perhaps less than half had none or very little at any one time during this period.

C. *Egg production and mating*

(a) *Fertile and infertile eggs.*

The bed-bug will not lay eggs unless it has mated and there is sufficient food in the midgut. Thus usually after moulting an adult, if mated, will not

oviposit (at 23° C.) unless it has been fed within a week from mating. The eggs it lays are of three kinds:

(1) Fertile eggs which hatch.

(2) Fertile eggs which develop partially but do not hatch.

(3) Unfertilized or sterile eggs which possess no serosa (Mellanby, 1939*a*) and shrivel up soon after oviposition—these are the 'taub' eggs of German authors. They appear in high proportion as the sperms become exhausted.

In any batch of eggs which appear to be normal, 3 or 4 days after oviposition (i.e. when no sterile or 'taub' eggs occur), a few will usually fail to hatch. There is, apparently, no means of telling at oviposition which eggs these are. Consequently whenever in this section on egg production reference is made to normal eggs, I mean eggs with normal appearance, i.e. those other than 'taub', or sterile eggs, as these, henceforth, will be called.

The relations of egg production and fertilization have been recently discussed by Mellanby (1939*a*).

(b) Repeatedly fed, mated females in the absence of males.

It will be noticed from Tables 26–29 that if females and males are kept together so that copulation is likely to occur frequently, there are, nevertheless, a small proportion of sterile eggs. So long as the total egg output remains constant, the proportion of sterile eggs is small and relatively constant.

If, however, females and males are kept together for 24 hr. so as to allow the females to become mated, the males are then removed, and the females fed regularly, the proportion of sterile eggs increases and at the same time fewer eggs are laid each successive week.

At 23° C. when females are fed once a week on rabbit in the absence of males (males and females were together for the first 24 hr. only) the mean egg production per female reaches its maximum 2 weeks after feeding and mating and then declines rapidly, with sterile eggs increasing in number and in proportion, until at the fifteenth week no more eggs are laid. The fall in egg production per female coincides with a fall in the number of females which lay eggs (although they do not die) and with a marked reluctance to feed after some weeks without a male (Table 30 and Fig. 16). If males are now placed with the females permanently, the egg production per female increases and the number of sterile eggs remains relatively constant and always small (Table 31 and Fig. 16). A decline in the mean egg production per female sets in later and coincides again with a decrease in the numbers of ovipositing females. Cessation of feeding occurs, but this time it is a prelude to death. Titschack (1930) also records that egg production is correlated with the age of the female and states that more blood is required to produce one egg as the female grows older.

A similar experiment in which bugs were fed twice a week produced a similar graph. The period of maximum egg production was, however, more prolonged. When the males were replaced with the females the egg production

underwent a similar rise and decline occupying about a similar period of time as with the bugs fed once a week.

The quantitative differences in these two experiments are set out in Table 30 and Figs. 16 and 17.

Let us consider this table. By doubling the opportunity to feed the mean number of eggs produced by each fertilized female is slightly raised, but it is increased only by about 22% and the rate of egg production is slightly raised from 8.12 to 10.51 eggs for each week a female lays eggs (female laying weeks): for this period during which eggs are produced is practically the same, within ± 0.5 week, namely, 182 and 178 female laying weeks. Doubling the opportunity to feed makes no difference to the proportions of sterile eggs which are

Table 30. *Egg production with repeated feeding. Males and females spent 24 hr. together. Males were then removed. Only fertilized females considered. 90% R.H. at both temperatures*

| ° C. | Meals per week (offered) | Total eggs | | % sterile | No. fertilized ♀♀ | (No. weeks eggs laid) × (No. ♀♀ laying) ♀ laying weeks | No. of eggs per fertilized ♀ | | No. of eggs per ♀ laying week | |
|------|--------------------------|------------|---------|-----------|-------------------|--|------------------------------|---------|-------------------------------|---------|
| | | Normal | Sterile | | | | Normal | Sterile | Normal | Sterile |
| | | 23 | 1 | | | | 1469 | 341 | 23.21 | 23 |
| | 2 | 1871 | 427 | 22.82 | 24 (23 at end) | 178 | 77.96 | 17.79 | 10.51 | 2.40 |
| 18 | 1 | 516 | 27 | 5.23 | 24 | 109 | 21.50 | 1.13 | 4.73 | 0.25 |

Table 31. *Egg production with repeated feeding. Males and females kept together after first exhaustion of sperms and only fertilized females considered. Females used were those in Table 30, fertilized a second time after first fertilization was exhausted (see Figs. 16 and 17)*

| ° C. | Meals per week (offered) | Total eggs | | % sterile | No. of fertilized ♀♀ | | ♀ laying weeks | No. of eggs per ♀ laying week | |
|----------|--------------------------|------------|---------|-----------|----------------------|--------|----------------|-------------------------------|---------|
| | | Normal | Sterile | | Start | Finish | | Normal | Sterile |
| | | 23° C. | 1 | | 1045 | 133 | | 12.73 | 24 |
| 90% R.H. | 2 | 2049 | 202 | 9.86 | 24 | 6 | 172 | 11.91 | 1.17 |

produced—this is 23.2 and 22.8 for once and twice a week respectively—and this is not surprising since the production of these eggs depends on the survival and amount of sperm within the female (see Mellanby, 1939*a*, for more details about this matter). The apparently normal eggs too which are laid towards the end of a female's life show increasing mortality according to Janisch (1935).

Comparing the effect of feeding frequency on the egg production we see that those fed twice a week produce more eggs than those fed once a week. And although the period between first and last eggs to be laid is about the same in bugs with the single and double weekly meals, those fed more often show the more female laying weeks, i.e. more females lay for a longer time. The rate of egg production is thus increased by about 32% from 8.93 to 13.08 eggs per female per laying week.

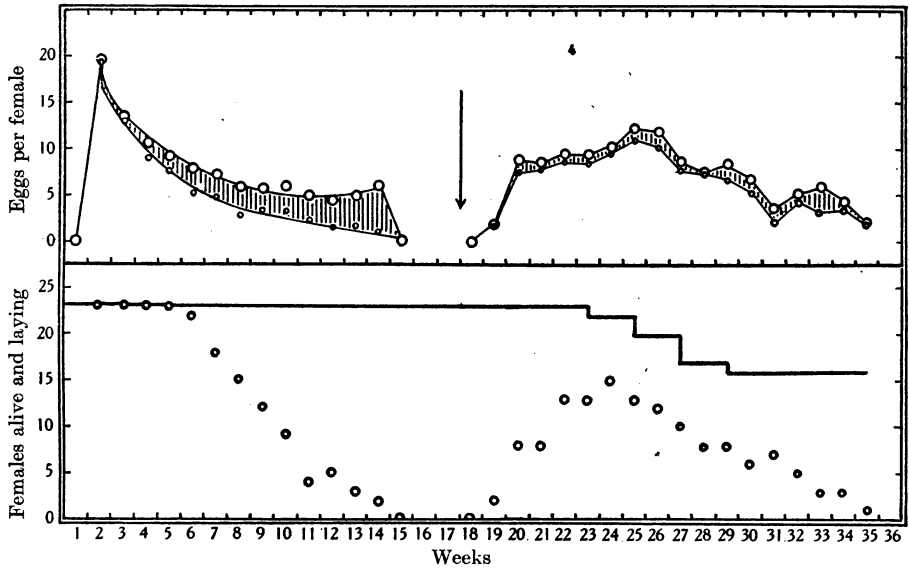

Fig. 16. Eggs per female per week, numbers of females laying and numbers of females alive at 23° C., 90% r.h. Top: ○ = total eggs; ○ = normal eggs. Bottom: ○ = females laying; — = females alive. Shaded areas represent sterile eggs. Females mated but afterwards kept without male until eighteenth week (arrow). Thereafter a male permanently with the female. Insects kept singly or in pairs per tube and fed once a week. Data in Tables 30 and 31.

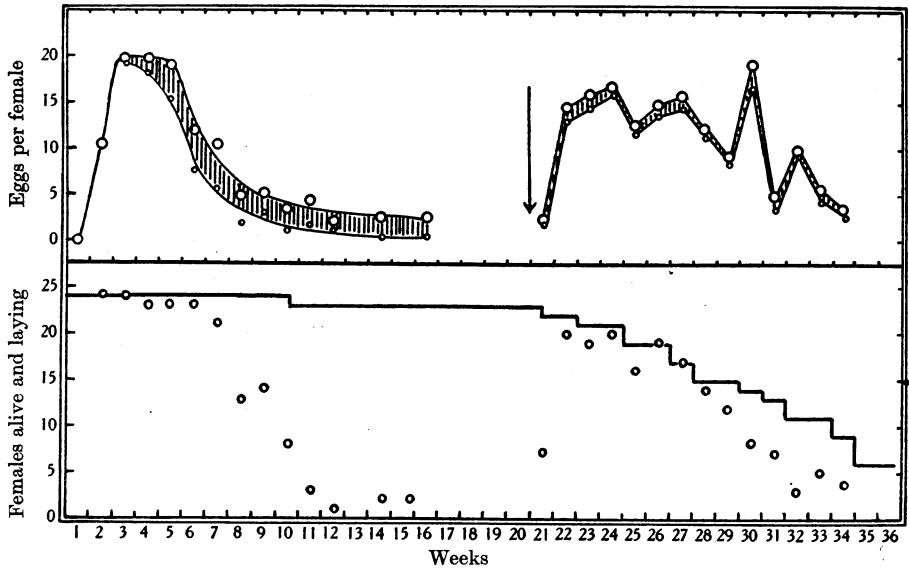

Fig. 17. As for Fig. 16 but fed twice a week. Data in Tables 30 and 31.

At 18° C. with bugs offered food once a week the percentage of sterile eggs is much lower than at 23° C. The number of female laying weeks and the weekly output of eggs per female is also much reduced (Table 30 and Fig. 18).

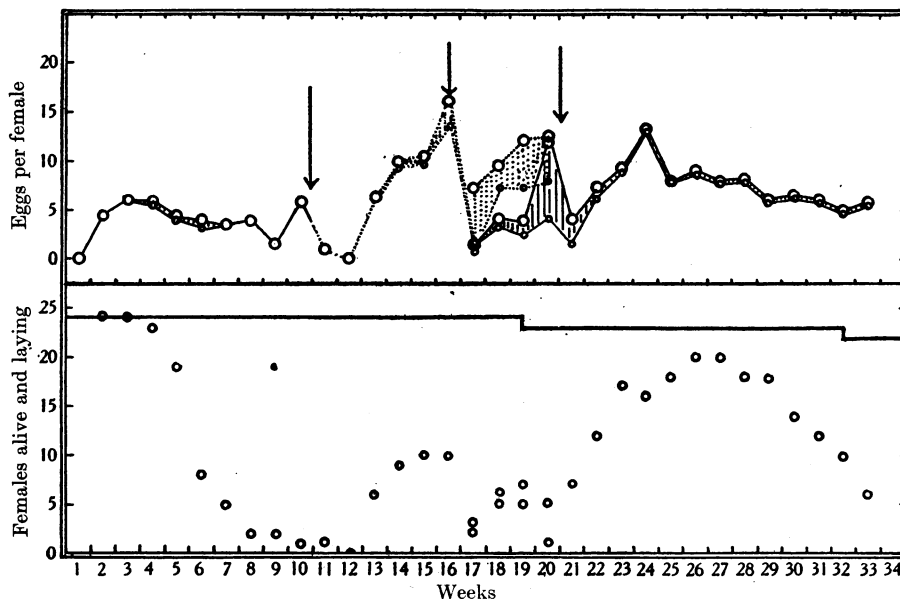

Fig. 18. As for Figs. 16 and 17 but at 18° C. and fed once a week. No male after first mating: 1-10 weeks all at 18° C.; 11-16 weeks all at 23° C.; 16-20 weeks half at 23° C. (dotted), half at 18° C. Permanent male 20-33 weeks all at 18° C. Data in Table 30.

(c) *The sojourn of mated females below the threshold temperature for egg production and the effect on subsequent oviposition.*

In the thermograph charts for 1935-6 it will be seen that mean monthly temperatures did not fall much below 7° C. for the coldest month, February. Of course temperatures below 7° C. for shorter periods were experienced, and no doubt in certain parts of the rooms such temperatures were maintained for a still longer period.

It is of interest, therefore, to know if female bed-bugs, fertilized but with no fully developed ovaries, can withstand prolonged exposure to such low temperatures.

An experiment was made with virgin females which were kept each with a male for 48 hr. at 23-28° C. The males were removed and the females, of which 90%, as a control experiment showed, could be regarded as fertilized, were placed at 7° C., 75% R.H. They were extracted after long periods, offered a blood-meal from rabbit and incubated at 23° C., 75% R.H., for several weeks. If no eggs were laid, a second meal was offered.

Often after prolonged exposure, the first feed was small and a second or third feed on the next day or two was given. Table 32 summarizes the experiment. It is clear that while the ovarioles are fertilized and the eggs but slightly

developed, 7° C. may be experienced for periods longer than those which occur in an English house during winter without females becoming sterile. It is, therefore, probable that females alone, if fertilized late in the previous autumn, can commence to reproduce when warm weather returns even if males are absent, or perhaps before they have begun to copulate.

The data in the table give no information on the effect of the sojourn at 7·0° C. on the subsequent numbers of eggs laid. But unless the weights of the blood-meals and other variables were strictly controlled, it would be unsafe to attribute any changes in egg output to the effect of temperature.

Table 32. *Renewal of ovarian development in fertilized females at 23° C., after long periods at 7 ± 1·0° C. (13·9° F.), i.e. 5–7° C. below the threshold for ovarian development. Each female kept 48 hr. with male at 23–28° C. Female then kept alone at 7° C., 75 % R.H., until removed for feed on rabbit and incubation at 23° C., 75 % R.H., to test for fertility*

| Period at 7° C. days | No. of ♀♀ used | No. of ♀♀ which fed | No. of ♀♀ which laid eggs |
|----------------------|----------------|---------------------|---------------------------|
| 156 | 9 | 9 | 9 |
| 196 | 5 | 2 | 2 |
| 206 | 15 | 10 | 8 |
| 260 | 5 | 5 | 4 |
| 270 | 12 | 12 | 10 |

(d) *The willingness and opportunity to mate.*

Mating at low temperatures. It may be that bugs can mate at all temperatures at which they walk about and this may occur at 9° C. (48·2° F.) (p. 429). But as Fig. 29 shows, the lower the temperature the smaller is the proportion of moving bugs, and this in itself will lessen the chances of males meeting females. I made some laboratory experiments below 15° C. (59° F.) and found that no successful mating occurred at 7–8° C. (44·6–46·4° F.) when several pairs of bugs were kept at the end of a tube on an area of 1 in. diameter. Neither did successful mating occur at 12·8–14·8° C. (55·0–58·6° F.) when ten pairs of bugs were kept on the same area. If copulation did indeed occur at temperatures below about 14° C. (57·2° F.) the eggs in the ovarioles were not successfully fertilized. 15° C. appears to be about the lowest temperature at which mating will occur at least in the absence of attempts at acclimatization. The results are summarized in Table 33.

Mating at 23° C. (73·4° F.). If virgin males and females are fed and allowed to remain together at 23° C. mating usually occurs in the first 24 hr.: mating rarely occurs before the first feed.

In an experiment on fecundity, 164 pairs of males and females were fed and immediately confined in single pairs on the voile at the end of 2 × 1 in. tubes for 24 hr. at 23° C. The males were then removed and the females kept for oviposition. 156, or 95·1 %, of the females had been fertilized. Cragg (1923) found that a newly fed male bed-bug fertilized three out of eight females when the insects were kept together for 24 hr. I have confirmed this and find that

a male bed-bug if newly fed is capable of fertilizing two or three females a day for several days after feeding. The details of this experiment are given in Tables 34 and 35.

Table 33. *The effect of various constant temperatures below 15° C. (59° F.) on successful mating. Virgin males and females fed and then kept separately at the experimental temperature overnight: then male quickly put with female. All experiments made on the voile at bottom end of a tube, 1 in. in diameter. Females eventually segregated, fed on rabbit and incubated for 3 weeks at 23° C.*

| ° C. | No. of pairs per tube | No. of tubes | Period together days | Subsequent incubation at 23° C. |
|-----------|-----------------------|--------------|----------------------|--|
| 7-8 | 1 | 9 | 19 | No eggs laid |
| 11.5-12.2 | 10 | 1 | 12 | No meal after extraction but refed after another 23 days. No eggs laid |
| 12.6-13.1 | 10 | 1 | 12 | 23 days. No eggs |
| 12.8-14.8 | 8 | 1 | 12 | 23 days. No eggs |
| 15.0±0.2 | 1 | 6 | 14 | Eggs laid by three females |

Table 34. *The number of successful matings by individual males in 6 days at 23° C. A single male and five virgin females, all freshly fed, were placed on the voile at the end of a 2 × 1 in. tube. Once every 24 hr. for 6 days the females were replaced by another five fed virgins. These extracted females were kept, singly in tubes, at 23° C. until no more eggs were laid. This showed the number fertilized. The male was fed only once—on the first day of the experiment. Five such experiments were made. The body of the table gives the number of females, in each daily batch of five, which laid either normal or normal and sterile (N) and only sterile eggs (S)*

| Days ... | 1 | | 2 | | 3 | | 4 | | 5 | | 6 | | Total per ♂ | |
|-----------------------|-----|-----|-----|---|-----|-----|------|---|------|---|------|------|-------------|---|
| | N | S | N | S | N | S | N | S | N | S | N | S | N | S |
| Exp. 1 | 2 | 1 | 1 | — | 2 | 1 | 1 | — | 3 | — | 1 | — | 10 | 2 |
| 2 | 2 | 1 | 3 | — | 2 | 1 | 2 | — | 2 | — | 2 | 1 | 13 | 3 |
| 3 | 2 | 1 | 1 | — | 2 | — | — | — | — | — | — | — | 5 | 1 |
| 4 | 1 | — | 1 | — | 1 | — | 1 | — | 2 | — | 1 | — | 7 | — |
| 5 | 2 | 1 | 1 | — | 1 | — | 1 | — | 2 | — | 1 | — | 8 | 1 |
| Total per day | 9 | 4 | 7 | — | 8 | 2 | 5 | — | 9 | — | 5 | 1 | — | — |
| Mean ♀♀ per ♂ per day | 1.8 | 0.8 | 1.4 | — | 1.6 | 0.4 | 1.25 | — | 2.25 | — | 1.25 | 0.25 | — | — |

Table 35. *Eggs laid by daily groups of five females fertilized by the same single male. All other data in Table 34. Numbers of eggs are given as normal plus sterile*

| Exp. | Days | | | | | |
|------------------------|---------|---------|---------|---------|---------|---------|
| | 1 | 2 | 3 | 4 | 5 | 6 |
| 1 | 11+1 | 4+0 | 15+1 | 7+0 | 24+0 | 10+0 |
| 2 | 17+1 | 20+1 | 7+3 | 16+1 | 14+1 | 16+1 |
| 3 | 19+2 | 5+0 | 7+3 | — | — | — |
| 4 | 3+0 | 4+0 | 1+2 | 8+0 | 19+0 | 6+0 |
| 5 | 17+1 | 2+1 | 4+0 | 6+1 | 12+0 | 7+0 |
| Total no. of eggs | 67+5 | 35+2 | 34+9 | 37+2 | 69+1 | 39+1 |
| Total laying ♀♀ | 13 | 7 | 10 | 5 | 9 | 6 |
| Mean eggs per laying ♀ | 5.2+0.4 | 5.0+0.3 | 3.4+0.9 | 7.4+0.4 | 7.7+0.1 | 6.5+0.2 |

It is clear that, in the laboratory, at least 5–13 matings can occur in 6 days: and this is possibly less than actually occurred, since the male may have fertilized some females twice within the 24 hr. Some females produced only sterile or unfertilized eggs: perhaps the sperms had become exhausted, but if the mean number of eggs per laying female are taken (Table 35) the proportion of unfertilized eggs shows no tendency to increase as the sixth day is approached, as would occur if numbers of sperms became exhausted.

The matings in these experiments occurred under very favourable conditions, i.e. at 23° C. on a confined area 1 in. in diameter, and the opportunities of a male meeting a female were probably maximal. It is difficult to say how often males copulate in nature: but it would appear that the limiting factors would be the chances with which males encountered virgin females rather than the ability of the male to copulate successfully.

With certain assumptions, however, the probability with which the females of a population can become impregnated can be estimated, and it is interesting to compare the expected values and those which actually occur in nature. I am indebted to Dr J. O. Irwin for the following mathematical argument.

We assume that each female in the population is equally likely to be chosen by a male for mating, that there are n males and n females, and each male mates twice a day. Then each day there will be $2n$ matings among the n females, i.e. *on the average* two matings per female per day. After 1 day some females will remain unimpregnated, and others will have mated one or more times.

The expected pregnancy of females who have remained virgin or have mated one, two, three or more times after t days will be

$$e^{-2t} \left(1, 2t, \frac{(2t)^2}{2!}, \frac{(2t)^3}{3!}, \frac{(2t)^4}{4!}, \dots, \text{etc.} \right).$$

When 60% are mated $e^{-2t} = 0.4$ or $t = 0.46$ day.

When 90% are mated $e^{-2t} = 0.1$ or $t = 1.15$ days.

Cragg's (1923) estimate (from laboratory work) of one copulation per female per day in a natural population would result in 90% of the females becoming mated after 2.3 days. So that if all females were equally exposed to risk in a population where all the males copulated twice in 24 hr. there would soon be no virgin females left: in a laboratory culture where males may mate three times a day the proportion of virgin females would decline with even greater rapidity.

In the next section some figures for the proportions of fertilized females in samples from wild populations are given. It is seen (Table 38) that even when bugs have been gathered from warm rooms and when the males predominate in the population, there still remain very high proportions, even up to about 85% of virgin females. Mellanby (1939*b*) also found that just over 10% of females which he trapped in a very warm animal house were virgin. That they had fed since the last moult indicated, moreover, that they were several days old and had moved about. Mellanby estimated that the females in his animal

house were fertilized on an average not more than once a week. This coincides approximately with periods of emergence for feeding.

There are several probable explanations why the proportions of fertilized females in a population are so much smaller than laboratory experiments would indicate: experimental work, however, on these problems with bug populations under natural conditions is lacking. It is obvious, however, that there are factors which prevent equal and random selection of females by males. Climate apparently plays a very important part and this is discussed again in Part II. We have seen that if a female is kept for 24 hr. at 23° C. with a male the effects of copulation (of which possibly three occurred) may last for many weeks at summer, and for many months at winter, temperatures (pp. 391-2). Thus if copulations occur at the rate of three a day during the warmest days of summer, by the autumn the infertile females in the population are likely to be virgins which had never mated and not females exhausted of sperms. As the temperature drops and copulation becomes less frequent it is plausible to suppose that the fifth instar which would moult into females in the autumn do not become impregnated until the following spring.

But data both on the maximum number of copulations possible at autumn temperatures and on the actual frequency of mating at these temperatures in nature are lacking. Neither do we know the natural frequency of copulation during the summer nor the effective length of a *single* copulation at various temperatures. The rate at which newly moulted virgins enter the adult population is also an essential fact and one on which data are lacking.

Until these matters are investigated it is idle to theorize too closely on the causes which lead to such large proportions of virgins or 'secondary virgins' in natural populations.

D. *The effects of inbreeding on egg production and fertility*

Inbreeding tends to segregate lethal and semilethal genes and might be expected to affect fertility by causing females to produce fewer eggs or to bring about a mortality in the egg or nymphal stages. A certain amount of inbreeding of cultures has been made, primarily to examine its effects on the sex ratio. Records were, however, kept of the layings and hatchings.

The breeding was carried out at 27-28° C. and 75% R.H., and bugs were fed twice, and later once, a week on rabbit. Virgin males and females were segregated from each generation and brother-sister matings made. Bugs of the parent generation, *P*, were brothers and sisters bred from stock cultures. Two strains were used: one from Beckenham which has been mass cultured in these laboratories since 1927 and a fresh strain, collected in Glasgow in 1938, which we had received here 3 or 4 weeks previously; with both, my work was done in 1938-40. The results are summarized briefly in Tables 36 and 37.

As far as the experiments go, they show that the percentage of fertile eggs tends to diminish as inbreeding proceeds, and that this process is perhaps more

Table 36. *Inbreeding of C. lectularius (Beckenham stock) at 27–28° C., 75 % R.H.*
Results of four experiments. Matings for next generation are always made from
first matings of previous generation except where stated otherwise (— = unknown)

| | Egg mortality % | Larval mortality % | No. of eggs |
|--------------------------|-----------------|--------------------|-------------------------|
| I | | | |
| $P-F_1$ | 1.47 | 3.08 | 136 |
| F_1-F_2 | 2.05 | 13.33 | 195 |
| F_2-F_3 | 4.60 | 20.48 | 174 |
| F_3-F_4 | 2.65 | — | 113 |
| F_4-F_5 | 0 | — | 39 ♀♀ died |
| II | | | |
| $P-F_1$ | 0.75 | 8.27 | 134 |
| F_1-F_2 | 75.3 | 61.1 | 73 |
| F_2-F_3 1st mating | — | — | No eggs laid |
| 2nd mating | — | — | Two infertile eggs laid |
| 3rd mating | — | — | No eggs laid |
| 4th mating | — | — | Ten infertile eggs laid |
| III | | | |
| $P-F_1$ | 3.91 | 22.40 | 128 |
| F_1-F_2 | 2.7–7.4 | 23–27 | 149 |
| F_2-F_3 | 1.83 | 16.82 | 109 |
| F_3-F_4 1st mating | 6.25 | — | 96 ♀♀ died |
| 2nd mating | 28.85 | — | 52 ♀♀ died |
| 3rd mating | — | — | 0 |
| 4th mating | 21.9 | — | 73 ♀♀ died |
| IV | | | |
| $P-F_1$ | 11.3 | 1.79 | 115 |
| F_1-F_2 | 1.39 | 21.13 | 144 |
| F_2-F_3 1st mating | 60.0 | — | 90 ♀♀ died |
| 2nd mating | 20.9 | — | 115 ♀♀ died |
| 3rd mating | 2.63 | — | 91 ♀♀ died |
| F_3-F_4 from 1st above | — | — | 35 ♀♀ died |
| from 2nd above | — | — | 28 ♀♀ died |

Table 37. *Inbreeding of C. lectularius (Glasgow sample) at 27–28° C., 75 % R.H.*
Results of three experiments. Matings for next generation are always made from
first matings of previous generation except where stated otherwise (— = unknown)

| | Egg mortality % | Larval mortality % | No. of eggs |
|----------------------|-----------------|--------------------|-------------|
| I | | | |
| $P-F_1$ | 8.22 | 15.0 | 146 |
| F_1-F_2 | 4.35 | — | 138 |
| F_2-F_3 1st mating | 3.39 | 35.09 | 59 ♀♀ died |
| 2nd mating | 16.67 | 35.00 | 24 ♀♀ died |
| F_3-F_4 | 5.6 | — | 36 ♀♀ died |
| II | | | |
| $P-F_1$ | 2.96 | 9.16 | 135 |
| F_1-F_2 1st mating | 10.88 | 22.40 | 147 |
| 2nd mating | — | — | 0 |
| F_2-F_3 1st mating | 77.46 | — | 71 ♀♀ died |
| 3rd mating | 41.67 | — | 84 ♀♀ died |
| F_3-F_4 | — | — | 69 ♀♀ died |
| III | | | |
| $P-F_1$ | 8.63 | 10.24 | 139 |
| F_1-F_2 | 20.92 | 23.14 | 153 |
| F_2-F_3 | 30.43 | 4.69 | 92 ♀♀ died |
| F_3-F_4 1st mating | 20.83 | — | 24 ♀♀ died |
| 2nd mating | 100.0 | — | 45 ♀♀ died |
| 3rd mating | 100.0 | — | 21 ♀♀ died |

rapid in the freshly collected bugs from Glasgow than in the older stock from Beckenham.

The results indicate, too, that nymphal mortality tends to increase with inbreeding, although an exceedingly strict watch on avoidable mortality during breeding was not kept. Suggestive, too, is the smaller numbers of eggs laid by inbred females: the females of the later generations usually died after producing comparatively few eggs, although a sufficient quantity of data for statistical tests have not been collected.

In the tables, where a female is not indicated as having died, it was still alive when a sufficient number of eggs for the immediate purpose had been obtained. It happened that in later generations feeding opportunities were more irregular, but this cannot account entirely for the later shortness of life.

It would seem that much inbreeding would be unlikely to occur in nature except perhaps in the very early stages of population growth. It is doubtful if it plays an important part in causing a diminution of a population. The problem in nature is bound up too with the fate of the sperms introduced into a female by successive matings by different males and what proportion of these are absorbed or fertilize eggs: nothing is known of the fate of sperms from successive males.

E. *The fertility of females from wild populations*

In laboratory cultures where males and females are kept together in nearly equal proportions in tubes, all the females soon become fertilized. But before the reproductive potential of the bug population in the wild state can be estimated we must know with what success mating occurs.

Experiments were started in order to discover the proportions of fertilized females in populations, and if changes in these proportions could be correlated with other conditions or events.

Bugs were collected from houses, brought into the laboratory and the sexes counted. The females were fed on rabbit: if they failed to feed or took a small meal the first time, they were given three or four other opportunities at daily intervals. When fully gorged, each female was placed alone in a test-tube with a slip of paper at 23° C. (73.4° F.). Any eggs laid were allowed to hatch.

The females which failed to oviposit or which laid only sterile eggs after the first meal were fed once more after about 2-3 weeks: but rarely did such females oviposit.

In this way a test was made of the proportions of females which laid fertile or a mixture of fertile and sterile eggs and those which either laid only sterile eggs or no eggs at all.

All collections from London were made personally and the sexes segregated on the spot. Unfortunately, with bugs sent from Glasgow and from Ireland it was not possible to have the males and females separated when collected: consequently some mating may have occurred in transit.

The original plan was to make collections throughout a whole year to see if there was a seasonal effect on fertility. Unfortunately, this was not possible: indeed, it is not an easy matter to obtain large and frequent samples, although this is not because bugs are scarce. I have therefore done no more than start what may be a promising investigation. Possibly on account of the small number of samples, no very strong correlations between fertility and other conditions, with one exception, are apparent. Because of this, and since the number of samples is far from sufficient, I have made little statistical analysis of the data.

Consideration of the data (Table 38 and Fig. 19).

By a fertile female I mean one which, after a blood-meal, and in the absence of a male, will lay either normal or a mixture of normal and sterile eggs. It should be noted that the percentage of fertile females in Table 38 is based on the number offered blood. The few which failed to feed may have been fertilized, but I have assumed that they would not feed in nature and therefore would lay no eggs.

The proportion of fertile females is very much lower in the samples from London than in those from Glasgow or from Ireland (Fig. 19). It is possible that fertilization in transit may partly account for this difference. But we notice, too, that all the London samples were from unheated and, with one

Table 38. *Key to wild samples. Further data in Table 48 and in the text*

| Sample | Date collected 1939 | Locality and habitat |
|--------|------------------------|--|
| | | Glasgow |
| A | 14. i | Wall of bed-recess in kitchen |
| B | 19. i | Bed-recess |
| C | 19. ii | Woodwork of bed. Room always heated |
| D | 3. iii | Bed-recess in kitchen |
| E | 23. iii | Bed-recess in kitchen |
| F | 5. vi | Kitchen bed-mattress |
| G | 7. vi | Bed-recess |
| H | 7. vi | Walls near bed |
| J | i, ii, iii, v, vi | Walls, bedboards and mattress in bed-recess All rooms occupied |
| | | London |
| K | 24. i | Door frame. Flat empty for 3 weeks |
| L | 18. ii | On and in walls and round grate. Unheated bedroom. 2 beds. Flat occupied |
| M | 12. iii | Door and window frame and old bedstead. Bedrooms. Flat empty 1-3 weeks |
| N | 15. iv | Door and window frame in heated bedroom. Flat empty 2 weeks |
| O | 1. v | Walls, corners, door-frames, in bedroom. Flat empty 1-2 weeks |
| | | Cork, Eire |
| P | 24. iii | — |
| Q | 25. iii | — |
| | | Dublin, Eire |
| R | 28. iv | Overcrowded, badly ventilated living and sleeping room. Behind wall plaster |
| S | iii, iv | Walls of bed-sitting rooms. Dublin, Belfast, Cork All rooms occupied |

Table 38 (continued)

All, except asterisked samples, are those in which not less than ten females were offered a blood-meal. J and S give pooled values for all samples in which less than ten females were offered food.

N = normal eggs. *S* = sterile eggs. 0 = no eggs laid.

Data on sex ratio, percentage fertile females and eggs from wild samples. Females fed once on rabbit and incubated at 23° C., after collection from infested dwellings.

| Sample | Total nos. | | % | ♀♀ offered meal/♀♀ fed | Nos. ♀♀ producing eggs | | | | % ♀♀ pro- ducing eggs (from nos. ♀♀ offered food) | | Total eggs | | | |
|--------|------------|-----|------|---------------------------------|---------------------------|-----|----|----|---|------|------------|-----|-------|------|
| | ♂ | ♀ | | | N | N+S | S | 0 | N and N+S | S+0 | N | S | % N | |
| | | | ♀♀ | | | | | | | | | | | |
| A | 47 | 25 | 34.7 | 23/ 22 | 9 | 5 | 5 | 3 | 60.9 | 39.1 | 179 | 33 | 84.4 | |
| B | 29 | 17 | 37.0 | 16/ 16 | 10 | 0 | 0 | 6 | 62.5 | 37.5 | 36 | 0 | 100.0 | |
| C | 41 | 26 | 38.8 | 20/ 16 | 3 | 7 | 1 | 5 | 50.0 | 50.0 | 97 | 18 | 84.3 | |
| D | 35 | 23 | 39.7 | 21/ 19 | 3 | 10 | 1 | 5 | 61.9 | 38.1 | 93 | 31 | 75.0 | |
| E | 19 | 21 | 52.5 | 18/ 17 | 5 | 9 | 2 | 1 | 77.8 | 22.2 | 186 | 38 | 83.0 | |
| F | 22 | 18 | 45.0 | 14/ 7 | 1 | 4 | 0 | 2 | 35.7 | 64.3 | 50 | 11 | 82.0 | |
| G | 32 | 21 | 39.6 | 16/ 9 | 3 | 6 | 0 | 0 | 56.3 | 43.7 | 187 | 9 | 95.4 | |
| H | 24 | 30 | 55.6 | 21/ 14 | 3 | 10 | 0 | 1 | 61.9 | 38.1 | 236 | 21 | 91.8 | |
| *J | 47 | 29 | 38.2 | 20/at least | 17 | 5 | 10 | 0 | 2 | 75.0 | 25.0 | 150 | 25 | 85.7 |
| K | 30 | 32 | 51.6 | 32/ 27 | 1 | 3 | 0 | 23 | 12.5 | 87.5 | 45 | 6 | 88.2 | |
| L | 88 | 87 | 49.7 | 65/ 63 | 11 | 2 | 6 | 44 | 20.0 | 80.0 | 132 | 17 | 88.6 | |
| M | 31 | 36 | 53.7 | 36/ 31 | 3 | 6 | 4 | 18 | 25.0 | 75.0 | 114 | 15 | 88.4 | |
| N | 166 | 174 | 51.2 | 168/136 | 9 | 17 | 24 | 86 | 15.5 | 84.5 | 276 | 111 | 71.3 | |
| O | 23 | 18 | 43.9 | 15/ 14 | 1 | 5 | 0 | 8 | 40.0 | 60.0 | 102 | 9 | 91.9 | |
| P | 57 | 66 | 53.7 | 60/ 57 | 10 | 18 | 16 | 13 | 46.7 | 53.3 | 375 | 136 | 73.4 | |
| Q | 125 | 39 | 23.8 | 16/ 15 | 8 | 5 | 1 | 1 | 81.3 | 18.7 | 183 | 27 | 87.1 | |
| R | 10 | 15 | 60.0 | 11/ 8 | 2 | 5 | 0 | 1 | 63.6 | 36.4 | 116 | 15 | 88.5 | |
| *S | 81 | 43 | 34.7 | 12/ 9 | 3 | 2 | 0 | 4 | 41.7 | 58.3 | 47 | 3 | 94.0 | |

General means and totals

| | | | | | | | | | | | | | |
|-----|-----|-----|------|---------|--|--|--|--|------|------|------|-----|------|
| A-J | 296 | 210 | 41.5 | 169/137 | | | | | 60.9 | 39.1 | 1214 | 186 | 86.7 |
| | | | | 81.1% | | | | | | | | | |
| K-O | 338 | 347 | 50.7 | 316/271 | | | | | 18.4 | 81.6 | 669 | 158 | 80.9 |
| | | | | 85.8% | | | | | | | | | |
| P-S | 273 | 163 | 37.4 | 99/ 89 | | | | | 53.5 | 46.5 | 721 | 181 | 79.9 |
| | | | | 89.9% | | | | | | | | | |

exception, from unoccupied rooms. And these London bugs were thin and rarely with evidence of a meal later than 1-3 months before collection. On the other hand, the Irish and Scottish samples all came from occupied and warm rooms and most had obviously fed a few days before being collected.

But apart from these differences the actual proportion of fertilized females is interesting: the proportion of infertile females is considerable. The mean values for proportion of fertile females out of the total number of females in the sample for the first three months of 1939 was only 18.4% from the London samples, and the highest value was but 40%. Even in heated and occupied rooms and with males and females mixed during transit, the mean proportion from Glasgow was only 60.9% and the highest value was 77.8%. Irish samples had a somewhat lower value.

With particular samples it is interesting to note that in C and F, where bugs were actually taken from the beds in rooms which were always heated,

the proportion of fertile females was only 50 and 35.7% respectively. These are, however, small samples. Sample L from a London flat contains a large number of bugs collected in February from a small occupied bedroom with two beds. The bugs were collected from the walls where they were thickly clustered. They were thin and apparently had not fed for 2 or 3 months. But only 20% of the females were fertile.

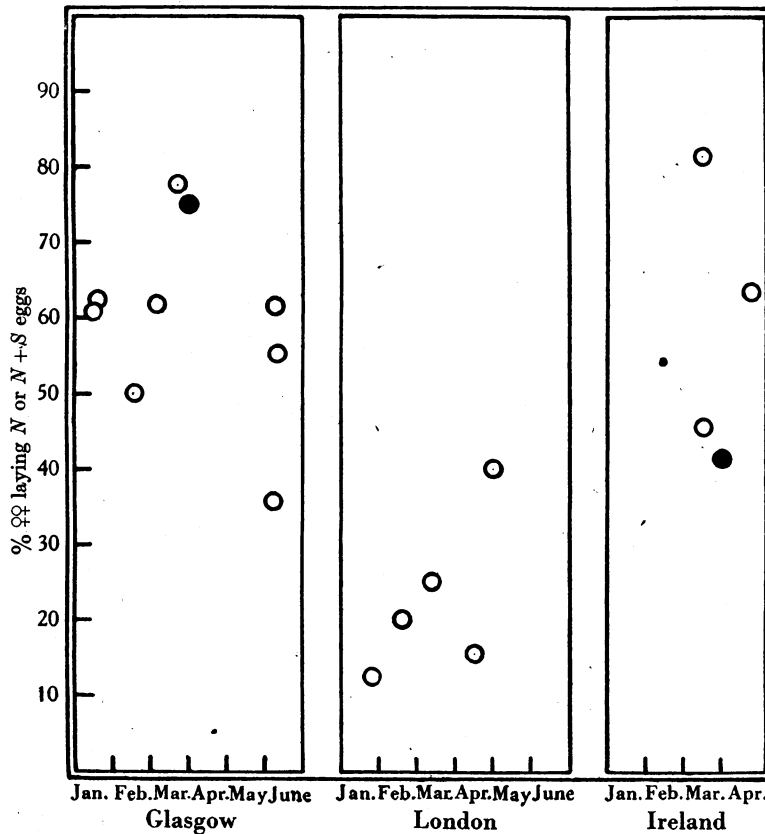

Fig. 19. Percentage of females in samples from wild populations which laid normal or a mixture of normal and sterile eggs when fed and placed at 23° C. Black circles are pooled values for several very small samples (J and S). Date collected, along abscissa. Data in Table 38.

The causes of barrenness of females are unknown: but there seem to be four possible reasons:

(1) Inbreeding produces females which lay only sterile eggs or which do not lay at all.

(2) Bugs may have moulted into adults late in the autumn and did not become fertilized before the temperature dropped below mating threshold.

(3) Fertilized ovarioles may have become exhausted: this would indicate that even in summer and early autumn mating is by no means frequent for

any one female. For the effects of copulation in August or September could easily last till the following February (p. 391).

(4) It may be that frequency of mating has little to do with the phenomenon, and that bugs which fail to oviposit may be exhibiting a kind of diapause akin to that observed for egg production at 18° C. In this case the results may be of some value in estimating how long before overwintering females commence to oviposit when temperatures rise above the threshold.

Fig. 19 suggests that as June is approached the proportion of fertile females increases. But the tendency must be slight, since pooled results show no correlation between proportion of fertile females and time of year between January and June. Other outstanding points are as follows:

Of those eggs which were laid usually over 80 % were fertile.

The sex ratio, expressed as a percentage of females in the whole sample, shows wide fluctuations with a general tendency for males to predominate in the Scottish and Irish samples.

A high percentage of females took a blood-meal even if they had been gathered in cold weather: a period at a low temperature in the laboratory usually tends to make bugs reluctant to feed.

There is no evidence that correlations exist between the sex ratio and the percentage of fertile females, proportion of fertile eggs, or time of year.

5. THE SURVIVAL OF FED AND STARVED ADULTS IN THE LABORATORY AND IN FREE-LIVING POPULATIONS AND THE SURVIVAL OF STARVED NYMPHS

A. Foreword

The study of egg mortality is relatively simple compared with mortality of adults or nymphs. For unlike eggs, adults and nymphs move about and feed: and the mortality rate is influenced by the amount of activity and by the frequency with which food is sought or found. The frequency with which mating occurs may also affect the length of life of the adult female. All these activities as well as the rate of metabolism will be influenced by temperature and some perhaps by humidity and radiation, while the age and sex of the bugs and individual and local variations on their constitution will affect the rates at which they die.

The variables whose effects are least understood are those associated with behaviour—feeding, movement, and mating. It is certain, too, that the extent to which these factors affect the mortality of adults varies between different populations where such factors as density of bug population and accessibility of the host add further to the complexity of the picture.

Thus it must not be supposed that the data given in this section, even where experiments were of a naturalistic kind, are necessarily common to most natural infestations.

While some conclusions of possible value may be drawn from the experiments with bugs confined in tubes at constant temperatures and fed at

arbitrary intervals, it must not be forgotten that the freedom of movement and choice of environment as well as the natural feeding cycle were absent. Moreover, in houses the temperature is not constant over periods of weeks as with the laboratory experiments.

B. Mortality in cultures: adults which mate freely and feed regularly

Bugs were kept at 22–23° C. and 75% R.H., about thirty pairs to each $2 \times 1\frac{1}{2}$ in. tube with paper to crawl on, and offered blood regularly once a week from rabbit. Eggs were removed twice a week. Cultures were renewed periodically by adults bred from the previous culture (Table 39 and Figs. 20 and 21). These bugs were from the Beckenham stock.

Table 39. *Mortality among adults of C. lectularius in stock cultures, at 22–23° C. and 75% R.H. Approx. thirty males and thirty females per $2 \times 1\frac{1}{2}$ in. tube. Offered blood from rabbit once a week (Figs. 20 and 21)*

A–E, Beckenham stock. B–E, successive batches of adults under 1 week old at start. Each batch bred from the one before.

| Nos. at start ... | A | | B | | C | | D | | E | |
|----------------------|-------------|-------|-------|-------|-------|-------|-------|-------|-------|-------|
| | ♂ | ♀ | ♂ | ♀ | ♂ | ♀ | ♂ | ♀ | ♂ | ♀ |
| 72 | 50 | 28 | 33 | 32 | 32 | 28 | 28 | 23 | 23 | |
| Weeks | % surviving | | | | | | | | | |
| 1 | 100.0 | 100.0 | 100.0 | 100.0 | 100.0 | 100.0 | 100.0 | 100.0 | 100.0 | 100.0 |
| 2 | 100.0 | 98.0 | 96.4 | 100.0 | 90.6 | 100.0 | 100.0 | 100.0 | 100.0 | 95.5 |
| 3 | 100.0 | 96.0 | 96.4 | 93.9 | 90.6 | 100.0 | 96.4 | 100.0 | 91.3 | 86.9 |
| 4 | 97.2 | 96.0 | 96.4 | 93.9 | 87.5 | 100.0 | 92.9 | 89.3 | 91.3 | — |
| 5 | 95.8 | 88.0 | 96.4 | 90.9 | — | 100.0 | 92.9 | 82.1 | 91.3 | 86.9 |
| 6 | 95.8 | 82.0 | 96.4 | 90.9 | — | 87.5 | 92.9 | 78.6 | 86.9 | 78.3 |
| 7 | 95.8 | 80.0 | 96.4 | 90.9 | 84.4 | 87.5 | 85.7 | 64.3 | 82.6 | 69.6 |
| 8 | 94.4 | 72.0 | 96.4 | 90.9 | — | — | 85.7 | 64.3 | 82.6 | 69.6 |
| 9 | 91.7 | 70.0 | 89.2 | 90.9 | — | — | 82.1 | 57.1 | 82.6 | 69.6 |
| 10 | 90.3 | 64.0 | 89.2 | 87.9 | — | — | 78.6 | 50.0 | 82.6 | 69.6 |
| 11 | 90.3 | 52.0 | 89.2 | 87.9 | — | — | 78.6 | 50.0 | 82.6 | 65.2 |
| 12 | 87.5 | 48.0 | 89.2 | 84.8 | — | — | 75.0 | 46.4 | 78.3 | 65.2 |
| 13 | 86.1 | 44.0 | 82.2 | 84.8 | — | — | 75.0 | 32.1 | 78.3 | 60.9 |
| 14 | — | — | — | 84.8 | — | — | 67.9 | 25.0 | 78.3 | 60.9 |
| 15 | — | — | — | 81.8 | — | — | 64.3 | 21.4 | 78.3 | 60.9 |
| 16 | — | — | — | 78.8 | — | — | 57.1 | 10.7 | 78.3 | 52.2 |
| 17 | — | — | 82.2 | 75.8 | — | — | 50.0 | 0 | 78.3 | 52.2 |
| 18 | — | — | — | — | — | — | 50.0 | 0 | 69.6 | 39.1 |
| 19 | — | — | — | — | — | — | — | — | — | 30.4 |
| 20 | — | — | — | — | — | — | — | — | 60.9 | 17.4 |
| 21 | — | — | — | — | — | — | — | — | 52.2 | 0 |
| 22 | — | — | — | — | — | — | — | — | 39.1 | — |
| 23 | — | — | — | — | — | — | — | — | — | — |
| 24 | — | — | — | — | — | — | — | — | 39.1 | 0 |

Mortalities in other cultures which were used for fertility experiments at 13, 18 and 23° C. and at 10 and 90% R.H. at each temperature have been tabulated (Table 40). These insects were kept in a less crowded state—five males and five females on the voile at the end of a 2×1 in. tube—and offered blood from rabbit once a week at 23° C.

Let us consider Table 39 and Figs. 20 and 21 where all insects were kept at 22–23° C. Except in culture B the females die off more rapidly than the males

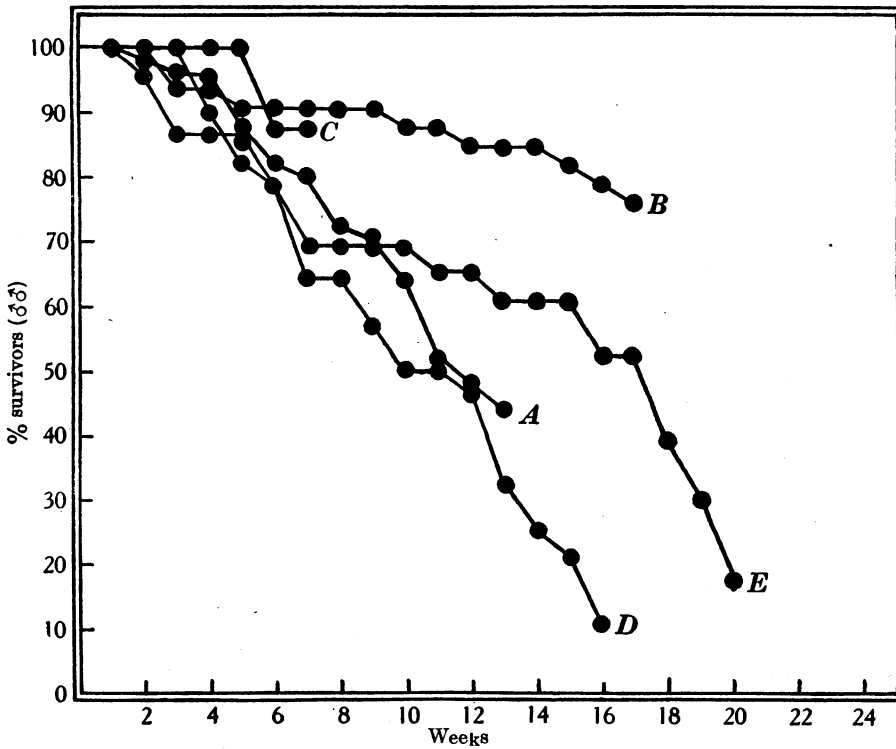

Fig. 20. Mortality of adult male *C. lectularius* in stock cultures at 23° C. Data in Table 39. A, B, etc., separate batches, all from one stock (Beckenham). Batches B to E each bred from the one before. Bugs under 7 days old at start.

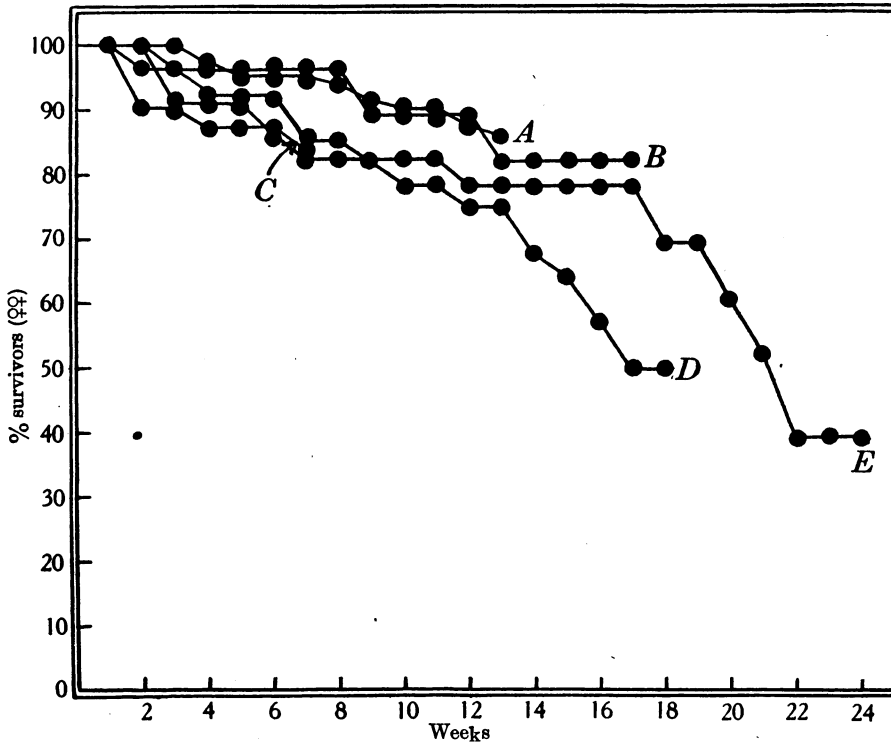

Fig. 21. Mortality of adult female *C. lectularius* in stock cultures at 23° C. Data in Table 39. A, B, etc., separate batches, all from one stock (Beckenham). Batches B to E each bred from the one before. Bugs under 7 days old at start.

(the reverse of Titschack's (1930) conclusion). Thus in spite of the uniform environmental conditions in which these bugs were kept, there is a great deal of variation between the mortality rates of different cultures. The clue may be in the length of time the first instars were kept without food prior to the start of the culture or in the different amounts of activity in the different cultures.

Turning now to the cultures at 13, 18 and 23° C., where bugs were kept under rather less crowded conditions (Table 40 and Fig. 22). Here, too, the females die off more rapidly than the males; at any rate at the higher temperatures. At 13° C. the effects of humidity and sex are very slight and probably not

Table 40. *Mortality among males and females of C. lectularius (Beckenham stock); fed once a week on rabbit at 23° C. Kept on voile at end of 2 × 1 in. tube; five males and five females per tube. Approximately 2 weeks old at start*

| % R.H. | 13 | | | | 18 | | | | 23 | | | |
|---------------|-------------|-------|-------|-------|-------|-------|-------|-------|-------|-------|-------|-------|
| | 10 | | 90 | | 10 | | 90 | | 10 | | 90 | |
| Nos. at start | ♂ | ♀ | ♂ | ♀ | ♂ | ♀ | ♂ | ♀ | ♂ | ♀ | ♂ | ♀ |
| start | 55 | 55 | 54 | 54 | 58 | 58 | 52 | 52 | 56 | 56 | 54 | 54 |
| Weeks | % surviving | | | | | | | | | | | |
| 1 | 100.0 | 100.0 | 100.0 | 100.0 | 100.0 | 100.0 | 100.0 | 100.0 | 100.0 | 100.0 | 100.0 | 100.0 |
| 2 | 100.0 | 98.2 | 100.0 | 100.0 | 100.0 | 98.3 | 98.1 | 100.0 | 100.0 | 99.2 | 100.0 | 100.0 |
| 3 | 100.0 | 98.2 | 100.0 | 100.0 | 98.3 | — | 98.1 | 100.0 | 100.0 | 98.2 | 100.0 | 100.0 |
| 4 | 100.0 | 98.2 | 100.0 | 100.0 | 98.3 | 96.6 | 98.1 | 100.0 | 100.0 | 89.3 | 96.3 | 94.5 |
| 5 | 100.0 | 94.5 | 100.0 | 100.0 | 98.3 | 94.8 | 98.1 | 100.0 | 98.2 | 87.5 | 94.5 | 92.6 |
| 6 | 100.0 | 94.5 | 100.0 | 100.0 | 98.3 | 94.8 | 94.2 | 100.0 | 96.4 | 82.2 | 88.8 | 83.3 |
| 7 | 98.2 | 94.5 | 100.0 | 100.0 | 98.3 | 94.8 | 92.3 | 94.2 | 94.6 | 80.4 | 87.0 | 77.8 |
| 8 | 98.2 | 94.5 | 100.0 | 100.0 | 94.8 | 94.8 | 90.4 | 88.5 | 92.9 | 76.8 | 85.2 | 75.9 |
| 9 | 98.2 | 94.5 | 98.1 | 100.0 | 94.8 | 89.6 | 86.5 | 86.5 | 92.9 | 71.4 | 85.2 | 74.1 |
| 10 | 98.2 | 94.5 | 98.1 | 100.0 | 93.1 | 87.9 | 80.8 | 84.6 | 92.9 | 69.6 | 85.2 | 70.4 |
| 11 | 98.2 | 94.5 | 96.3 | 100.0 | 91.4 | 87.9 | 80.8 | 82.7 | 92.9 | 67.8 | 85.2 | 68.5 |
| 12 | 98.2 | 92.8 | 96.3 | 100.0 | 91.4 | 84.5 | 78.8 | 80.8 | 92.9 | 64.3 | 85.2 | 66.7 |
| 13 | 96.3 | 92.8 | 96.3 | 100.0 | 91.4 | 82.8 | — | 76.9 | 92.9 | 58.9 | 85.2 | 66.7 |
| 14 | 94.5 | 92.8 | 96.3 | 100.0 | 91.4 | 82.8 | 78.8 | 73.1 | 91.0 | 46.4 | 81.5 | 59.3 |
| 15 | 94.5 | 92.8 | 96.3 | 100.0 | 89.6 | 81.0 | 76.9 | 73.1 | 89.3 | 42.8 | 79.7 | 57.4 |
| 16 | 94.5 | 92.8 | 96.3 | 100.0 | 89.6 | 77.6 | 76.9 | 73.1 | 87.5 | 35.7 | 79.7 | 55.6 |
| 17 | 94.5 | 92.8 | 96.3 | 100.0 | — | 77.6 | 76.9 | 73.1 | 85.7 | 32.1 | 77.8 | 51.9 |
| 18 | 94.5 | 92.8 | 96.3 | 100.0 | — | 75.9 | 76.9 | 73.1 | 82.2 | 32.1 | 75.9 | 48.1 |
| 19 | 92.8 | 92.8 | 96.3 | 100.0 | — | 75.9 | 75.0 | 69.3 | 76.8 | 30.4 | 75.9 | 46.3 |
| 20 | 92.8 | 92.8 | 96.3 | 100.0 | — | 75.9 | 75.0 | 67.3 | — | — | — | — |
| 21 | 92.8 | 92.8 | 96.3 | 92.6 | — | 75.9 | 69.3 | 67.3 | — | — | — | — |
| 22 | — | — | — | — | — | 75.9 | 67.3 | 67.3 | — | — | — | — |
| 23 | — | — | — | — | 86.2 | 75.9 | 67.3 | 53.8 | — | — | — | — |
| 24 | — | — | — | — | — | — | 67.3 | 51.9 | — | — | — | — |
| 25 | — | — | — | — | — | — | 65.4 | 51.9 | — | — | — | — |

statistically significant. At 18° C., although females die off more quickly than males both have a higher mortality rate at 90 than at 10% R.H. At 23° C. the same differences with respect to sex are evident, but females at 10% R.H. die off more quickly than those at 90% R.H.—the reverse to the insects at 23° C. With the males the effect of humidity is less noticeable.

We see from Fig. 15 that females at 23° C. and 10% R.H. lay more eggs than at 23° C. and 90% R.H., and this higher metabolic rate and presumably greater activity may account for their relatively short life.

The general effect of temperature is, however, quite well marked: in general the higher mortality rates occur at the higher temperatures. Where the

humidity was high, however, there was little difference between mortality rates at 18 and 23° C., and during the period of the experiment the effects of temperature are less with males than with females.

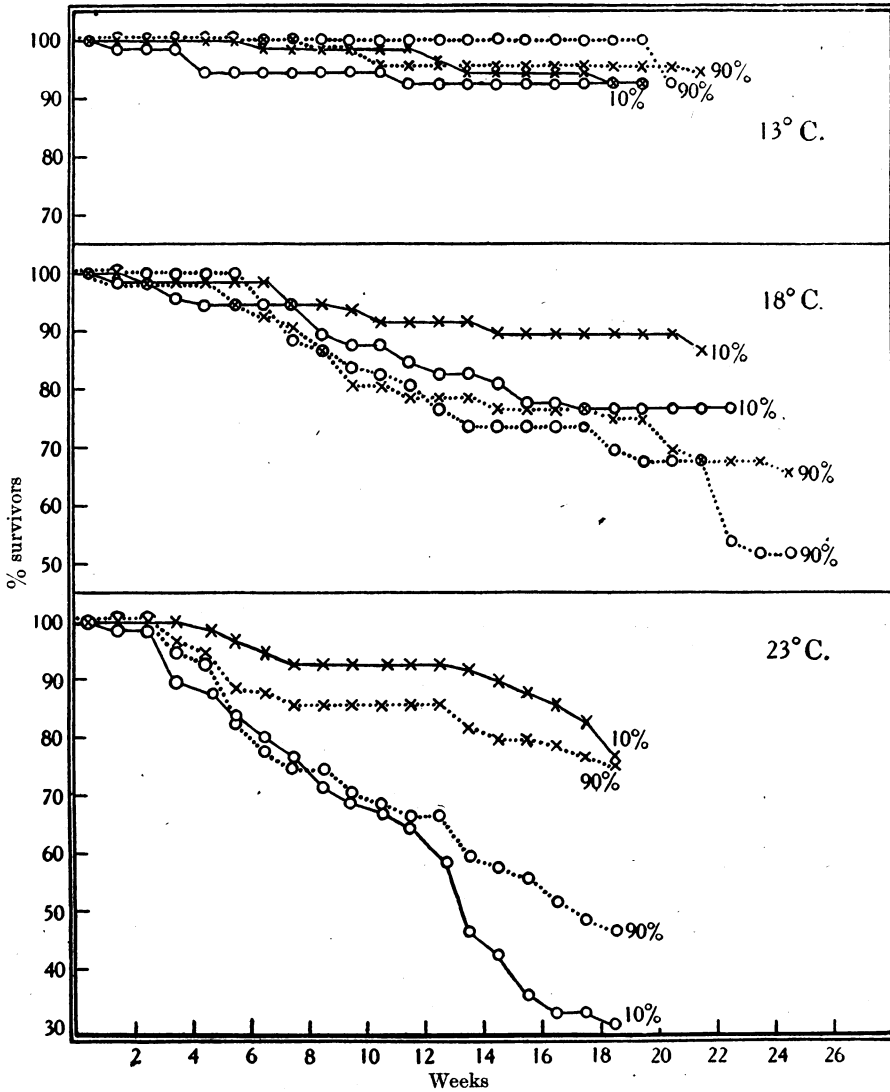

Fig. 22. Mortality among males (x) and females (o) *C. lectularius* at various temperatures and humidities when fed once a week. Five males and five females per 2 x 1 in. tube. Data in Table 40.

If these experiments at 18 and 23° C. are compared with those at 22–23° C. (Figs. 20 and 21), it is clear that batches of the same culture at 22–23° C. may show differences in mortality rates as different as those between the two different temperatures of 18 and 23° C. (Fig. 22).

*C. Survival of fasting nymphs and adults**(a) Survival of fasting adults.*

The survival of adult bed-bugs, which had been fed once as adults and then set aside and starved, presents some interesting physiological problems particularly those related to water loss and the role of water in the blood-meal. Such problems are fully discussed in another paper (Johnson, 1940*b*) and have no immediate bearing on the problems of population ecology.

Our interest in fasting bugs is limited largely to problems associated with the survival of bug populations during the winter or in uninhabited houses. This has a practical importance in the control of the pest and also a theoretical interest in helping us to estimate the extent of a growth of a population on resumption of tenancy by man.

I give in this subsection some of the data concerning adults already published in the above-mentioned article. Figs. 23 and 24 and Table 41 speak for themselves: the survival periods are probably almost maximal for the strains used, for activity was reduced to a minimum and bugs had no opportunity for the frequent and prolonged wanderings which, when they occur in nature, may lead to early death. Moreover, the temperatures were constant and therefore for those at and below 15° C. were maintained for longer periods than occur in nature.

Virginity and survival. Table 41 and Fig. 24 give the data. Females which are given one feed, kept with a male and allowed to lay eggs and are then starved till death, do not live so long as unmated females fed once. Copulation (i.e. the two or three on the day after the first feed) appears to have no effect on length of life of the males: for those which were kept unmated and singly in tubes live precisely as long as those kept permanently with a female. These results apply to 23 and 7° C., although the females laid no eggs at 7° C.

This result agrees, as far as the effects of fertilization are concerned, with that of Mellanby (1939*a*). Like Kemper (1930) I find that with mated adults, males outlive females, except at the lowest temperature (7° C.) in the experiments. With virgin bugs, however, females live longer than males.

(b) Survival of fasting nymphs.

Tables 42-44 and Figs. 25-27 give the data for survival under various constant conditions in the laboratory. The mean length of life is, over a wide range of humidity, at a constant temperature limited mainly by water loss: this would perhaps not apply with very active insects. As with adults nymphal longevity increases as the temperature drops to about 13 or 15° C. and decreases as the temperature falls below this, at a constant saturation deficit. This phenomenon is discussed elsewhere (Johnson, 1940*b*). No correlation between the weight of fifth instars before a meal and longevity was detected. There was also no correlation between longevity and the weight of the meal when bugs were fed to repletion. These facts applied also to adults.

Table 41. Mean and maximum length of life in days of adult *C. lectularius*, mated and unmated and fed once on rabbit. Maximum length of life of, for example, 291-8, means that death occurred between 291st and 298th day. Longevity dates from feeding—4 days after moulting (Figs. 23 and 24)

| ° C. | % R.H. | Male | | | | Female | | | |
|---------|--------|-------------|---------------------|--------|------------------------|-------------|---------------------|--------|------------------------|
| | | No. of bugs | Mean length of life | s.D. | Maximum length of life | No. of bugs | Mean length of life | s.D. | Maximum length of life |
| Mated | | | | | | | | | |
| 7 | 10 | 48 | 208.8 | 37.04 | 291-8 | 24 | 228.4 | 29.14 | 306-12 |
| | 90 | 23 | 219.5 | 71.66 | 382-90 | 23 | 285.6 | 104.94 | 460-9 |
| 13 | 10 | 21 | 186.8 | 48.64 | 256-63 | 22 | 179.0 | 49.04 | 235-42 |
| | 90 | 22 | 338.3 | 85.46 | 464-71 | 21 | 359.7 | 109.41 | 562-72 |
| 18 | 10 | 22 | 98.6 | 28.18 | 148-53 | 21 | 90.69 | 22.51 | 139-41 |
| | 90 | 19 | 151.5 | 64.35 | 257-64 | 19 | 143.05 | 51.31 | 222-7 |
| 23 | 10 | 22 | 40.3 | 13.02 | 57-60 | 22 | 38.32 | 12.94 | 67 |
| | 90 | 25 | 85.2 | 22.87 | 135-7 | 25 | 69.4 | 25.97 | 126-28 |
| Unmated | | | | | | | | | |
| 7 | 90 | 21 | 222.8 | 113.61 | 518-31 | 21 | 317.21 | 139.10 | 550-3 |
| 23 | 90 | 20 | 86.6 | 22.4 | 126-31 | 18 | 120.7 | 44.5 | 181-5 |

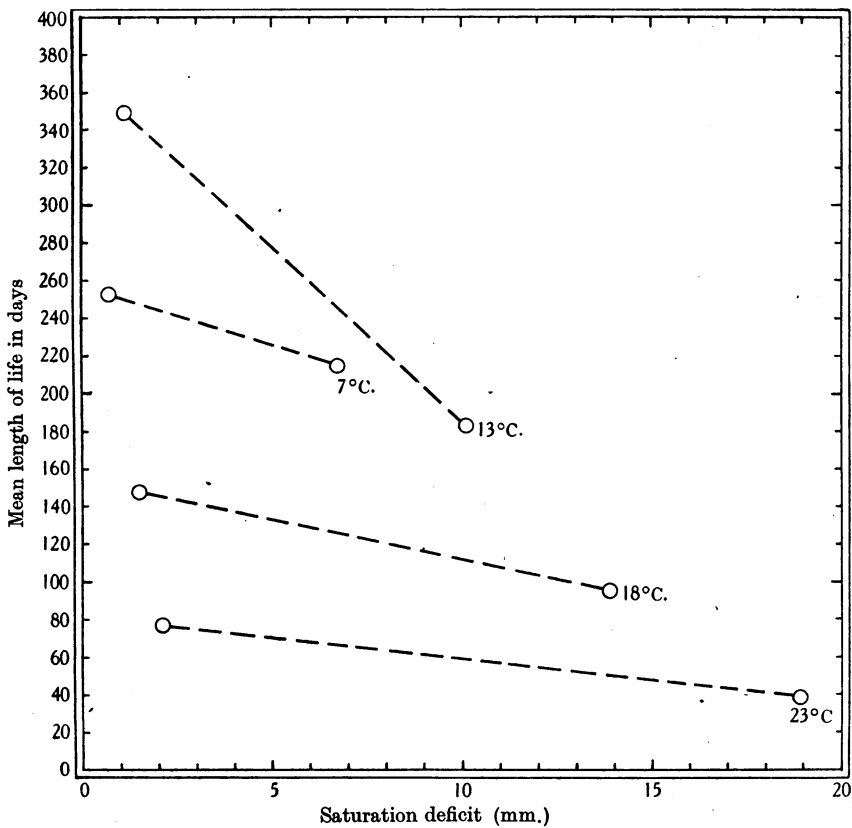

Fig. 23. Mean length of life of fasting mated adults of *C. lectularius* (males and females together), fed once on rabbit, in relation to temperature and humidity. Longevity dates from feeding. Dotted lines merely join the two observations at each temperature and do not indicate length of life at intermediate humidities (Table 41).

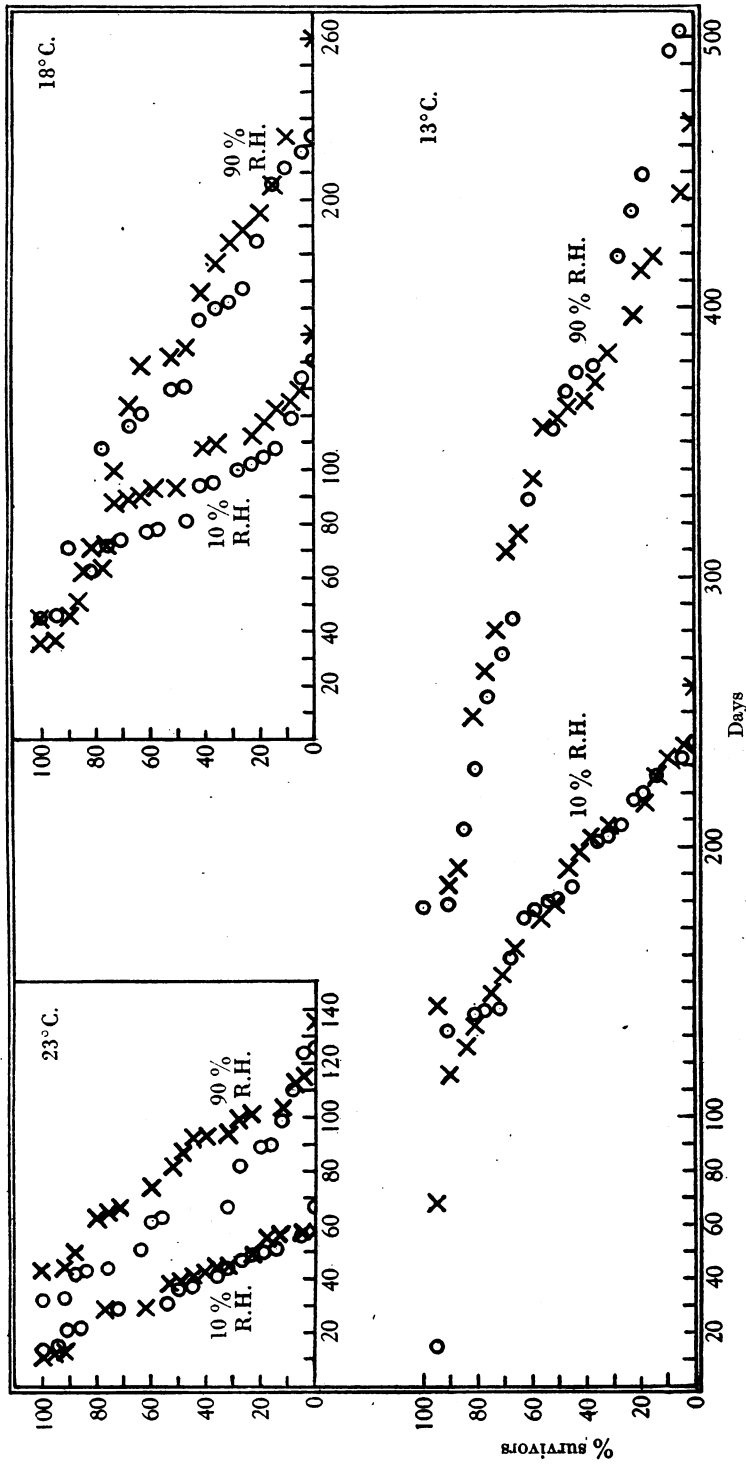

Fig. 24. Mortality of fasting adults of *C. lectularius* (x = males, O = females) at various temperatures and humidities. Mean length of life in Table 41 and Fig. 23 are based on these data. Insects kept singly in 2 x 1 in. tubes.

Table 42. *Observed and expected mean lengths of life and the maximum observed length of life of unfed first instars of C. lectularius at constant temperatures and humidities. All the values date from hatching. The expected mean lengths of life are the values on the best fitting hyperbolas obtained from the data by the method of least squares and the linear regression of log. mean against log. saturation deficit (Figs. 25-27). Insects were inspected at intervals: therefore a maximum length of life of, for example, 80-83 days is shown as 80-3 in the last column*

| ° C. | ° F. | % R.H. | Sat. def. mm. | Mean lengths of life days | | s.d. of observed | No. of bugs used | Maximum observed length of life days |
|------------|------|--------|---------------|---------------------------|----------|------------------|------------------|--------------------------------------|
| | | | | Observed | Expected | | | |
| 7.0 ± 0.8 | 44.6 | 6 | 7.05 | 53.0 | 52.0 | 14.83 | 108 | 80-3 |
| | | 27 | 5.50 | 60.4 | 57.1 | 18.12 | 78 | 103-6 |
| | | 56 | 3.30 | 65.0 | 69.3 | 22.80 | 138 | 111-14 |
| | | 90 | 0.75 | 123.5 | 121.2 | 41.36 | 127 | 210-3 |
| 15.0 ± 0.2 | 59.0 | 6 | 12.03 | 46.6 | 47.5 | 17.42 | 81 | 106-9 |
| | | 27 | 9.34 | 52.5 | 52.1 | 9.67 | 82 | 74-7 |
| | | 56 | 5.60 | 64.0 | 63.2 | 14.49 | 132 | 102-5 |
| | | 90 | 1.30 | 108.4 | 109.1 | 31.37 | 109 | 183-6 |
| 18.5 ± 0.4 | 65.3 | 6 | 15.0 | 24.2 | 27.4 | 4.83 | 66 | 38-40 |
| | | 28 | 11.6 | 32.4 | 30.6 | 5.12 | 59 | 42-4 |
| | | 57 | 6.9 | 42.8 | 38.2 | 13.04 | 71 | 71-4 |
| | | 90 | 1.6 | 66.4 | 70.9 | 20.23 | 50 | 132-5 |
| 25.0 ± 0.3 | 77.0 | 7 | 22.10 | 13.3 | 15.6 | 2.09 | 106 | 20-2 |
| | | 29 | 16.90 | 19.5 | 17.8 | 2.63 | 79 | 28-30 |
| | | 58 | 10.0 | 29.1 | 23.6 | 6.04 | 87 | 44-6 |
| | | 90 | 2.40 | 45.7 | 49.7 | 11.95 | 85 | 68-71 |
| 28.0 ± 0.3 | 82.4 | 7 | 26.4 | 11.3 | 13.7 | 2.17 | 30 | 14-6 |
| | | 29 | 20.10 | 15.4 | 15.2 | 2.47 | 32 | 20-2 |
| | | 58 | 11.9 | 22.2 | 18.7 | 4.66 | 49 | 32-4 |
| | | 90 | 2.9 | 31.1 | 32.2 | 6.56 | 88 | 44-6 |

Table 43. *Observed, mean and maximum lengths of life of first to second instars of C. lectularius at constant temperatures and humidities. The bugs were fed once, as first instars, on rabbit 2 days after hatching. Length of life dates from hatching. The numbers used refer to those insects which died as second instars except at 7° C. when moulting did not occur and all remained as first instars. Temperature variations as in Table 42*

| ° C. | % R.H. | Sat. def. mm. | Mean length of life days | s.d. | Maximum length of life days | No. of bugs used |
|------|--------|---------------|--------------------------|--------|-----------------------------|------------------|
| 7 | 6 | 7.05 | 98.6 | 43.40 | 155-60 | 44 |
| | 90 | 0.75 | 195.6 | 111.98 | 340-50 | 36 |
| 15 | 6 | 12.03 | 98.3 | 33.45 | 150-5 | 13 |
| | 90 | 1.30 | 223.6 | 59.90 | 355-60 | 33 |
| 25 | 7 | 22.10 | 23.8 | 2.59 | 28 | 46 |
| | 90 | 2.40 | 53.8 | 10.89 | 66-8 | 37 |

Table 44. Mean and maximum lengths of life of fourth to fifth instars at 22.5° C. 75% R.H. Bugs were reared on man (A. H. and C. J.) with one feed an instar at 22.5° C., 75% R.H. Unfed fourth instars were allowed to feed once, to repletion, 9 days after moulting. These were allowed to moult and the fifth instars were allowed to starve to death without further food. Longevity dates from feeding of fourth instar

| Host | No. of bugs | Mean length of life in days and s.d. | Max. length of life days |
|-------|-------------|--------------------------------------|--------------------------|
| A. H. | 51 | 140.15 : 8.99 | 179 |
| C. J. | 43 | 130.17 : 11.98 | 175 |

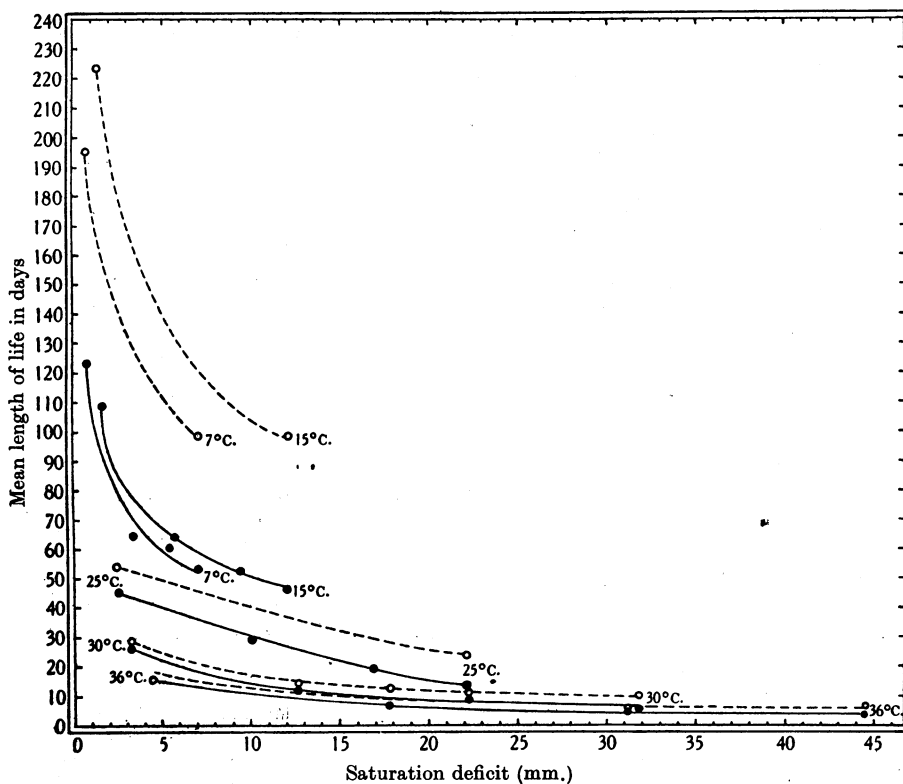

Fig. 25. Mean length of life of unfed and fed first instars (fed first = unfed second instars at 15° C. and above) of *C. lectularius* in relation to temperature and humidity. All lines fitted visually (Tables 42 and 43). Data at 30 and 36° C. from Mellanby (1935).

○---○ Fed. ●—● Unfed.

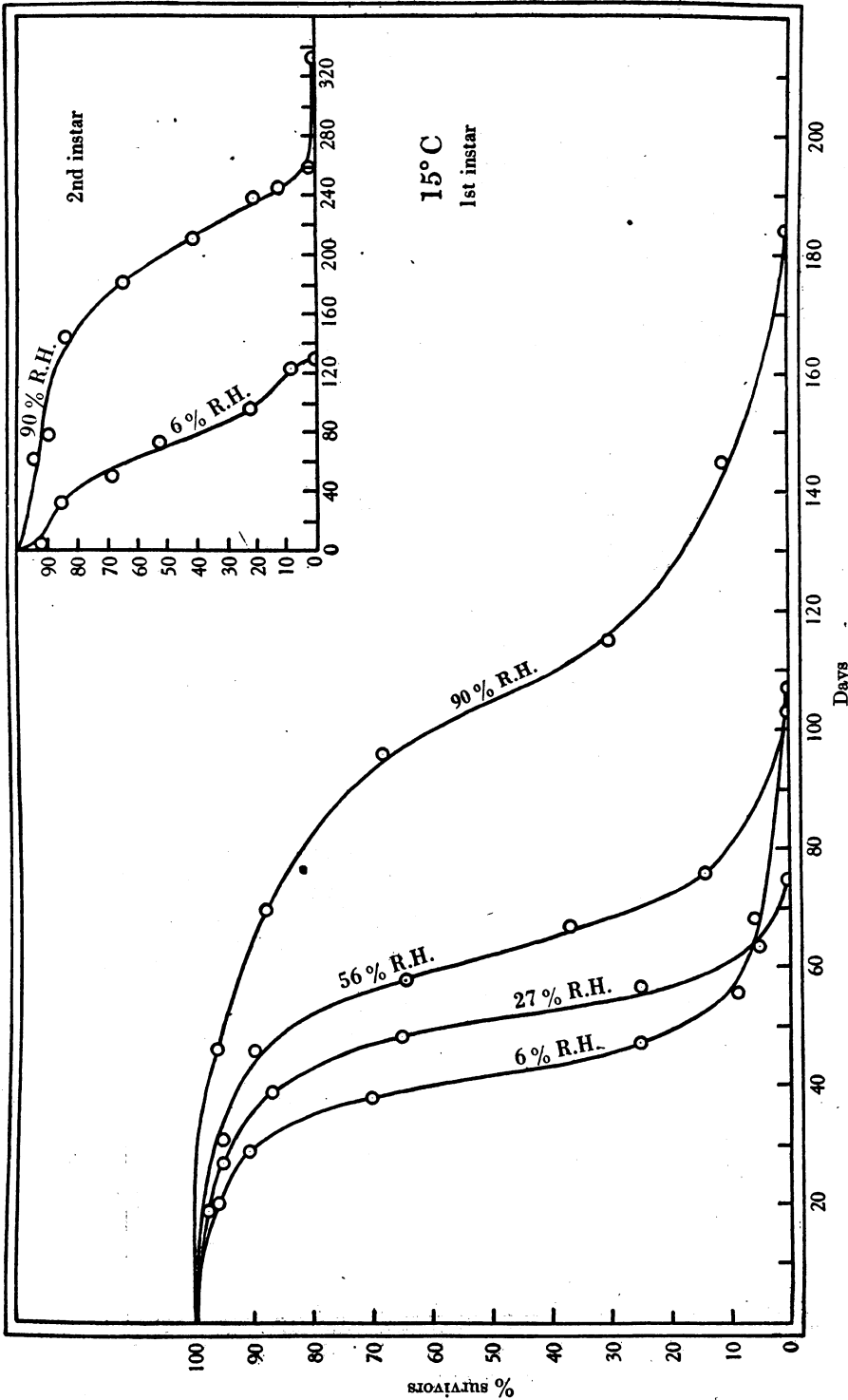

Fig. 26. Mortalities of unfed first and second instars of *C. lectularius* at constant temperature of 15° C. and at various humidities (6-90%). Means in Tables 42 and 43 based on these data.

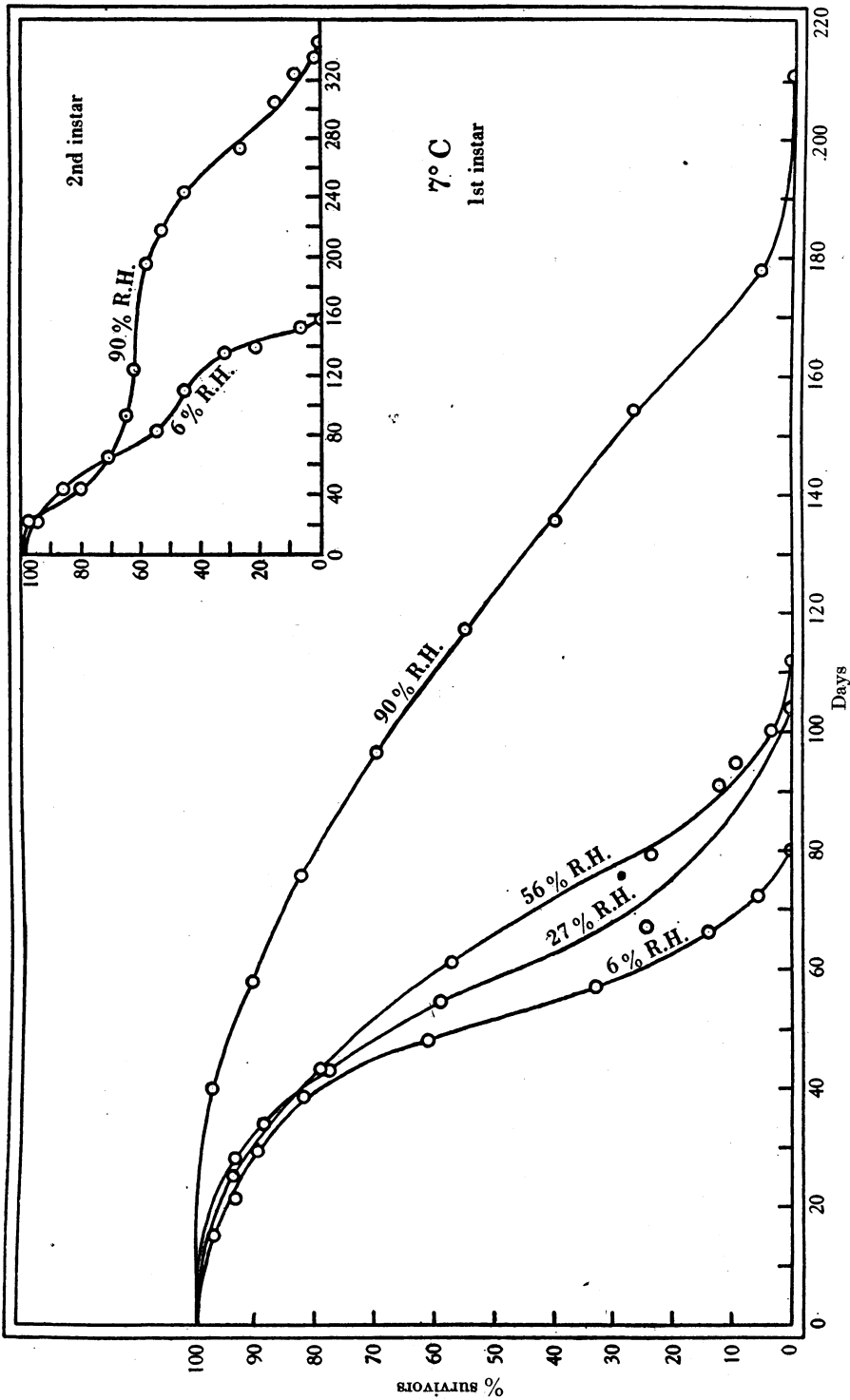

Fig. 27. Mortalities of unfed first and second instars of *C. lectularius* at constant temperature of 7° C. and at various humidities. Means in Tables 42 and 43 based on these data.

(c) *Some maximal times of survival including records of other workers.*

I have given here only those records of survival which are accompanied by a description of the conditions of the experiment. There are many other records in the literature but with little data on conditions: these are summarized by Titschack (1930).

With adults Geisthardt records 326 days at 14° C., but since the bugs were kept at 22° C. for 2 days before the experiment he estimates that they may have lived for 600 days had they been kept at 14° C. continuously. The longest-lived adult in my experiments was a female at 13° C., 90% R.H. (about optimal for survival): she died between the 562nd and 572nd day after moulting from the fifth instar. Although this bug was kept for many months with a male she laid no eggs (13° C. is the ovipositional threshold), so there is some doubt if she was mated: but if so then this period of survival would be by no means the maximum, for virgin bugs are the longer lived. It is conjectural whether it would have fed and oviposited towards the end of the starvation period. Gunn (1933) records that adults were kept for 3 and 4 years with occasional feeds and that mating occurred between them: conditions were not stated and the case is exceptional.

Kemper (1930) found that, of all the stages, the fifth instars and the adult males were able to survive starvation longest. His data at 22° C., 40–45% R.H., in days are

| Mean survival (days) | Instars | | | | 5—adults | |
|----------------------|---------|------|-------|-------|----------|-------|
| | 1 unfed | 1-2 | 2-3 | 4-5 | ♂ | ♀ |
| Mean survival (days) | 46·3 | 83·7 | 126·4 | 141·8 | 142·6 | 130·6 |

My own results show a somewhat similar relationship. Omori (1938), working with *C. lectularius* at 0° C., concluded that fed adults survived longest and could live for more than 175 days, while few unfed first instars lived more than 150 days. Geisthardt, however, found that first instars hatched at 18° C. lived up to 180 days and attributes the long survival time at this temperature to the fact that the eggs hatched at 18° C. and not at 27° C. In my experiments maximum survivals for unfed first instars were 210–13 days at 7° C. and 90% R.H. and 355–60 days for second instars at 15° C. and 90% R.H. Bacot (1914) kept bugs fasting in various stages of development in an outhouse for 18 months and induced them to feed after this period.

Thus it may be expected that if a house has remained unoccupied for a long time, fifth instars, unmated adult females or mated males would be most likely to predominate in the surviving population. But until the effects on longevity of the variables listed on p. 401 have been worked out, it is not possible to say what the maximum survival time could be.

D. *Mortality of adults in free-living populations*

The laboratory experiments on mortality show the rate at which bugs die when kept under strictly controlled climatic conditions with regular feeding, or with none at all, and with a minimal degree of active movement.

In nature, however, the climate is variable; blood may not be ingested regularly and the amount of movement undertaken by the bugs is probably considerable and with an effect on mortality not yet assessed quantitatively and precisely. Some figures are, however, available for mortality in free-living populations.

In an experimental room (see Appendix A) bug populations were kept with and without a host, and the numbers which died naturally were counted from day to day. From these data Tables 45-47 and Fig. 28 have been constructed which show the percentages remaining alive as time went by.

Table 45. *Survival of fed adults in experimental hut. Bugs bred at 23-26° C., and about 3 weeks old at start of experiment (kept at 18° C. since fifth moult). Harbourages on walls II and IV 6 in. from wall I and 2 ft. from floor. Mean temperature = 18.6° C. (max. = 25.6° C., min. = 8.9° C.). See Fig. 28 and Table 53. Nos. alive include those eaten before or after by host*

| Males | | | Females | | |
|------------------|---------|--------------------------|-------------------|---------|--------------------------|
| Date 1939 | Day no. | No. (also %) alive | Date 1939 | Day no. | No. (also %) alive |
| | 1-38 | 100 | 25. iv | 1 | 100 |
| 25. iv-1. vi | 39-41 | 99 | | 2-4 | 99 |
| | 42 | 98 | | 5 | 97 |
| | 43 | 93 | | 7 | 96 |
| | 44 | 90 | | 9-13 | 95 |
| | 45 | 89 | | 14 | 94 |
| | 46 | 87 | | 15-41 | 93 |
| | 47 | 87 | | 42 | 92 |
| | 49 | 85 | | 43 | 91 |
| | 50 | 84 | | 44 | 90 |
| | 51 | 84 | | 45-6 | 88 |
| | 52 | 82 | | 47-50 | 87 |
| | 54-7 | 80 | | 51 | 86 |
| | 58 | 79 | | 52 | 85 |
| | 59-65 | 78 | | 53 | 84 |
| | 66 | 77 | | 54 | 83 |
| | 67 | 76 | | 56 | 82 |
| | 68 | 75 | | 57 | 80 |
| | 70-2 | 74 | | 58 | 73 |
| | 73-6 | 73 | | 59-65 | 70 |
| | 77 | 72 | | 66 | 69 |
| | 78 | 71 | | 67-9 | 68 |
| | 79-81 | 70 | | 70 | 67 |
| | 82 | 65 | | 71 | 65 |
| | 84-94 | 64 | | 72-4 | 64 |
| | 95 | 63 | | 75-81 | 63 |
| | 96 | 62 | | 82 | 57 |
| | 97-9 | 61 | | 84-9 | 56 |
| | 100 | 60 | | 90 | 55 |
| | 101 | 59 | | 91-2 | 54 |
| | 102 | 57 | | 93 | 53 |
| 8. viii-15. viii | 106-113 | 54 | | 94-5 | 52 |
| | | | | 96-100 | 51 |
| | | | | 101 | 50 |
| | | | | 102 | 44 |
| | | | | 106-8 | 43 |
| | | | | 109 | 42 |
| | | | 12. viii-15. viii | 110-113 | 41 |

For further details of hut see Appendix A.

Let us consider Table 45 first: bugs were kept from 25 April till 15 August 1939 in the hut. For the first 6 weeks no host was present, but for the rest of the time a rabbit or a fowl was placed there each night. The mean temperature during the whole of the period was 18.6° C. (65.5° F.) and the maximum and minimum recorded temperatures were 25.6 and 8.9° C. (77.2 and 48.0° F.) respectively. Bugs were considerably active (see Fig. 30) but only a few fed: yet if the slope of the mortality curve is compared with those in the laboratory experiments at 18° C. (Fig. 24) it will be seen that the mortality in the hut

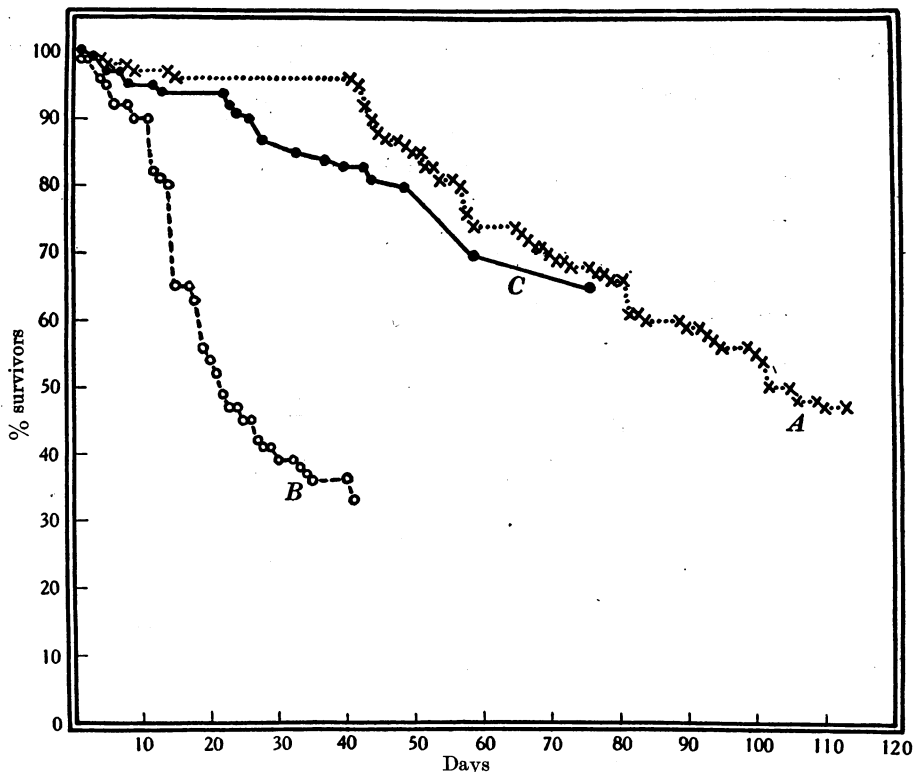

Fig. 28. Mortalities of *C. lectularius* adults in the experimental hut. A. Males and females: mean temperature = 18.6° C., max. 25.6° C., min. 8.9° C. Data in Table 45. B. Males and females: mean temperature = 12.3° C., max. 16.1° C., min. 9.2° C. Data in Table 46. C. Males only: mean temperature = 13.7° C., max. 17.1° C., min. 10.6° C. Data in Table 47. See also p. 426.

and in the laboratory are not widely different, if it is assumed that the humidity in the hut was between 10 and 90% R.H. As with the laboratory experiments the bugs in the hut were fed at the beginning of the experiment.

Longevity in the laboratory experiments is at its maximum at about 13° C. (if the saturation deficits are constant). But in the hut the mortality rate is so rapid that at mean temperatures of 13.7 and 12.3° C. (Tables 46 and 47) it is comparable to the laboratory results at 23° C. (cf. Figs. 22 and 24). The bugs died more quickly at 12.3 than at 18.6° C. in the hut. In the two experiments at

mean temperatures of 12.3 and 13.7° C. the rates of mortality are widely different. In one case (12.3° C.) a host was present and there was much more

Table 46. *Survival of adults in experimental hut. Adults bred at 23° C., less than 2 weeks old and unfed at start of experiment. Two guinea-pigs kept continuously in cage in corner between walls I and IV. Harbourages on walls II and IV each approximately 1 ft. from cage. Temperatures are means from maximum and minimum temperatures recorded by all thermometers in hut. Dead insects recorded daily: 'insects alive' are calculated accordingly and include those eaten before or after by guinea-pigs. For further details of hut, see Appendix A, and of experiment, see pp. 424-9*

| Date 1938 | Day no. | No. (also %) insects alive calculated | | Mean daily temp. ° C. |
|--------------|---------|--|------|-----------------------------|
| | | ♂ | ♀ | |
| 28. x | 1 | 100 | 100 | — |
| | 2 | 99 | 100 | 11.7 |
| | 3 | — | 100 | — |
| | 4 | 96 | 97 | 11.5 |
| 1. xi | 5 | 94 | 97 | 12.4 |
| | 6 | 90 | 95 | 11.6 |
| | 7 | 90 | 95 | 12.2 |
| | 8 | 90 | 95 | 14.3 |
| | 9 | 86 | 95 | 16.0 |
| | 10 | — | — | — |
| | 11 | 85 | 95 | 15.2 |
| | 12 | 80 | 84 | 14.5 |
| | 13 | 80 | 83 | 13.4 |
| | 14 | 78 | 83 | 14.1 |
| | 15 | 62 | 68 | 14.2 |
| | 16 | 62 | 68 | 15.1 |
| | 17 | — | — | — |
| | 18 | 59 | 68 | 16.1 |
| | 19 | 50 | 62 | 14.9 |
| | 20 | 49 | 59 | 14.0 |
| | 21 | 48 | 56 | 14.3 |
| | 22 | 45 | 53 | 14.3 |
| | 23 | 43 | 52 | 13.5 |
| | 24 | — | — | — |
| | 25 | 43 | 47 | 11.1 |
| | 26 | 43 | 47 | 9.8 |
| | 27 | 40 | 45 | 10.5 |
| | 28 | 38 | 44 | 10.6 |
| 29 | 38 | 44 | 10.2 | |
| 30 | 37 | 41 | 11.2 | |
| 31 | — | — | — | |
| 32 | — | — | — | |
| 33 | 37 | 40 | 9.2 | |
| 34 | 37 | 37 | 10.1 | |
| 1. xii | 35 | 37 | 36 | 10.0 |
| | 36 | 37 | 36 | 9.8 |
| | 37 | 37 | 36 | 9.5 |
| | 38 | — | — | — |
| | 39 | 37 | 35 | 9.6 |
| 7. xii | 40 | 37 | 35 | 9.8 |
| | 41 | 36 | 30 | 10.5 |

activity than when the host was absent (mean temp. 13.4° C.). The relative amounts of activity can be measured by the standard deviations about the mean percentages of bugs of the total population which are on the walls, floor

and ceiling of the hut: this gives some measure of the fluctuation in the numbers active outside the harbourages.

Table 47. *Survival of adult males in experimental hut. No host in hut. 170 newly fed males introduced behind harbourage of corrugated card. Temperatures are means from maximum and minimum temperatures recorded by all thermometers in hut. For further details of hut, see Appendix A, and of experiment, see pp. 424-9*

| Date 1938 | Day no. | % insects alive | Mean daily temp. ° C. |
|--------------|---------|--------------------|--------------------------|
| 31. iii | 1 | 100 | 16.4 |
| 2. iv | 3 | 99.4 | 15.5 |
| | 5 | 97.1 | 13.4 |
| | 6 | 97.1 | 12.8 |
| | 7 | 97.1 | 13.2 |
| | 8 | 95.9 | 14.4 |
| | 9 | 95.9 | 15.0 |
| | 12 | 95.3 | 11.8 |
| | 13 | 94.7 | 12.4 |
| | 22 | 94.2 | 10.6 |
| | 23 | 92.3 | 12.2 |
| | 24 | 91.7 | 12.2 |
| | 26 | 90.7 | 12.2 |
| | 28 | 87.6 | 11.8 |
| | 2. v | 33 | 85.3 |
| 37 | | 84.7 | 13.8 |
| 40 | | 83.6 | 12.6 |
| 43 | | 83.0 | 15.4 |
| 44 | | 81.2 | 16.7 |
| 49 | | 80.0 | 15.8 |
| 28. v | 59 | 70.6 | 15.0 |
| 14. vi | 76 | 65.3 | 17.1 |

Further details of activity in these two cases are discussed in § 8, but we can indicate here the relative activity at 12.3 and 13.7° C.:

| Relative mortality rate (B and C, Fig. 28) | Host | Mean temp. ° C. | Mean % active | S.D. | Length of experiment |
|--|---------|-----------------|---------------|------|-----------------------------------|
| ● Rapid | Present | 12.3 | 21.2 | 9.0 | 40 days. ♂♂ and ♀♀ unfed at start |
| ● Slow | Absent | 13.7 | 5.8 | 3.5 | 75 days. ♂♂ only fed at start |

Thus the greater activity occurred with unfed bugs and when a host was present and coincided with a higher mortality rate. It cannot of course be said that there is a significant correlation where we only have two samples and other uncontrolled variables, but the result is suggestive. It must be remembered, too, that humidity was not measured.

From these scanty data for mortality rates in free-living bug populations and their comparison with mortality rates measured in laboratory experiments with confined bugs it is seen that this is an unexplored aspect of the insect's biology and that at present hard and fast conclusions are impossible.

It is obvious from the preceding pages that a good deal of discrepancy between the results of the various experiments on mortality and survival exists. Some factors which may have contributed to this diversity are discussed in another paper (Johnson, 1940*b*).

E. *Lethal temperatures*(a) *High temperatures.*

The egg. Mellanby (1935) gave the following figures for *C. lectularius* eggs within 24 hr. old and reincubated at 23° C. after exposure:

| Exposure hr. | ° C. | ° F. | % dead |
|-----------------|------|-------|--------|
| 1 | 43 | 109.4 | 0 |
| 1 | 45 | 113.0 | 100 |
| 24 | 40 | 104.0 | 0 |
| 24 | 41 | 105.8 | 100 |

Atmospheric humidity was without effect on the thermal death-point and death was due to the effects of heat alone.

Nymphs (first instar). Bacot's (1914) results for unfed first instars may be summarized as follows:

| Exposure | ° C. | ° F. | % dead |
|----------|-----------|-------------|--------|
| 1.5 hr. | 43.0 | 109.4 | 0 |
| 1.0 hr. | 44.0 | 111.2 | 0 |
| 1.5 hr. | 44.0-44.4 | 111.2-112.0 | 100 |
| 1.75 hr. | 45.0 | 113.0 | 100 |
| 10 min. | 45.0 | 113.0 | 0 |
| 15 min. | 45.0 | 113.0 | 100 |

Blacklock (1912) states that 5 min. at 113° F. (45.0° C.) will kill nymphs.

Kemper (1932) found that first instars exposed for 10 min. at 45-46.5° C. (113.0-115.7° F.) failed to develop normally.

Adults. Mellanby (1935) found that the thermal death-point for adults of *C. lectularius* for exposures of 1 and 24 hr. was 1° C. lower than that for eggs. As with eggs, humidity during exposure had no effect.

Drenski (1928) states that all stages (including eggs?) are killed in 24 hr. at 40° C. and nymphs are killed instantly at 45° C.

Janisch (1933, 1935) finds that although exposures to moderately high temperatures of 32, 34 and 40° C. for 24 hr. may not kill eggs or larvae, injuries are caused which will create a high mortality in the future generations and may eventually cause a population to die out.

(b) *Low temperatures.*

The egg. Hase (1930) found that 2 hr. at -15° C. (5.0° F.) resulted in a 76% mortality.

Nymphs and adults (Kemper, 1936). Adults and larvae put out overnight at temperatures which went down to -18° C. survived as follows:

| ° C. | ° F. | % died |
|------|------|--------------|
| -15 | 5.0 | 0 |
| -16 | 3.2 | 75 |
| -17 | 1.4 | 100 in 2 hr. |
| -18 | -0.4 | 100 in 1 hr. |

Fed first instars at -18 to -20° C. died either at once or subsequently after a few days.

Replete bugs appeared to be less resistant to cold than unfed ones, and although death may not be caused by a short period of cold, injury may occur which causes bugs to die at the next moult. Kemper states that bugs in unheated, empty houses are not usually killed when there is a severe and lasting frost outside.

The upper and lower death-points are, then, fairly well defined, although exact data on the lower one are lacking. It is conceivable, too, that the temperature at which bugs were kept before being subjected to extremes of temperature may have a slight influence on the lethal temperature (see Mellanby, 1939*c*).

In England it is very unlikely that bugs would be subjected to such intense heat or cold that they would be killed by it in a very short time. In exposed places, however, and in roof spaces (Fig. 4) periodic exposures to super-optimal temperatures may eventually cause a mortality in the population. Much will depend, however, on the ability and opportunity of bugs to leave such places before injury could be effective.

6. THE COMPOSITION OF WILD POPULATIONS OF BED-BUGS

Some account of the proportions of virgin and fertilized adult females has already been given in § 4. We now turn to the further composition of wild populations gathered during the first half of the year. The data are obviously very incomplete.

The proportions of nymphs. The proportions of nymphs in overwintered populations are given in Table 48. Except for the Glasgow and Irish samples whose bugs frequently showed evidence of recent feeding, the adults and the nymphs were exceedingly starved. Thus for London samples collected from unheated bedrooms, they represent the survivors of the winter fast (see Part II, p. 442).

In heated bedrooms and bed-sitting rooms (Glasgow, Ireland) there is evidence that some hatching and oviposition occurs very early in the year (Table 48), and that this is not so with the colder types of room (London).

The proportions of the various nymphal stages in a population where moulting and reproduction are proceeding actively (temp. = 20–27° C.) are given by Mellanby (1939*b*).

The numbers of fed and unfed bugs trapped, in 'Demon' traps from which there was no escape, were as follows: I have given in brackets below each figure its percentage to the nearest whole number of the total number caught:

| | Nymphal instars | | | | | Adults ♂ and ♀ |
|----------------------|-----------------|-------------|-------------|------------|------------|-------------------|
| | I | II | III | IV | V | |
| March (14 days) | 201 (22) | 167 (18) | 145 (16) | 95 (10) | 87 (10) | 211 (23) |
| May (9 days) | 138 (21) | 106 (16) | 82 (13) | 55 (9) | 44 (7) | 218 (34) |
| Aug.–Sept. (11 days) | 15 (15) | 10 (10) | 13 (13) | 12 (12) | 16 (16) | 31 (32) |

These figures are compared with the expected proportions in a hypothetical population in Part II (p. 441) and agree with them very closely.

The sex ratio in adults. If bugs are bred in the laboratory equal numbers of males and females are produced (see also Hase, 1917, 1919; Kemper, 1936). This is also the case with the Beckenham stock (Table 49). But with a stock

Table 48. *Proportions of nymphs in samples of overwintered populations of C. lectularius*

| Sample | Collection date | New eggs | Nymphs | | | | | Adults |
|---------|-----------------|----------|-----------|----------|----------|----------|----------|-------------|
| | | | I | II | III | IV | V | |
| Glasgow | | | | | | | | |
| A | 14. i | — | — | — | — | — | — | 72 |
| B | 19. i | — | — | — | — | — | — | 46 |
| C | 19. ii | — | — | — | 2 | 6 | 15 | 67 |
| D | 3. iii | — | 3 | 3 | 6 | 6 | 6 | 58 |
| E | 23. iii | — | — | — | — | 1 | — | 40 |
| F | 5. iv | Several | — | — | — | — | — | 40 |
| G | 7. vi | „ | 1 | — | 1 | 2 | 4 | 53 |
| H | 7. vi | „ | — | — | — | — | 7 | 54 |
| J | i-vi | „ | 18 | — | 9 | 8 | 22 | 76 |
| | Total | | 22 (4) | 3 1 | 18 4 | 23 5 | 54 11 | 506 100) |
| London | | | | | | | | |
| K | 24. i | — | — | — | — | — | — | 62 |
| L | 18. ii | — | — | — | 1 | 3 | 15 | 175 |
| M | 12. iii | — | — | — | 2 | 8 | 16 | 67 |
| N | 15. iv | — | — | — | 2 | 13 | 50 | 340 |
| O | 1. v | — | — | — | 1 | 5 | 6 | 41 |
| | Total | | | | 6 (1) | 29 4 | 87 13 | 685 100) |
| Ireland | | | | | | | | |
| P | 24. iii | — | 1 | 2 | 4 | 13 | 13 | 123 |
| Q | 25. iii | — | — | 3 | 23 | 27 | 33 | 164 |
| R | 28. iv | — | — | — | 2 | 12 | 16 | 25 |
| S | iii-iv | — | — | — | 9 | 10 | 21 | 124 |
| | Total | | 1 | 5 (1) | 38 9 | 62 14 | 83 19 | 436 100) |

Table 49. *The sex ratio of adult C. lectularius subjected to inbreeding at 27–28° C. in the laboratory. The sex ratio expressed as percentage males appears unbracketed in the body of the table. Figures in brackets are the numbers of males*

| Genera- tion | Beckenham matings | | | | Glasgow matings | | |
|-----------------|-------------------|-----------|-----------|-----------|-----------------------|------------------------|-----------|
| | 1 | 2 | 3 | 4 | 1 | 2 | 3 |
| F_1 | 60 (78) | 46.7 (57) | 54.6 (53) | 50.0 (55) | 49.6 (59) | 77.3 (92) | 56.1 (64) |
| F_2 | 49.7 (84) | 57.1 (4) | 52.4 (54) | 50.9 (57) | 53.8 (43) | 65.0 (63) 78.2 (68) | 57.0 (53) |
| F_3 | 48.5 (64) | — | 49.4 (44) | — | 70.3 (26) 53.9 (7) | — | 55.7 (34) |

bred from the fresh material from Glasgow, males often emerge in greater numbers than females. *Cimex* has a complex sex-chromosome system and is characterized by the possession of many X-chromosomes in the nucleus. It appears that freshly caught bugs have a high X content (2–14 chromosomes), while those which have been mass cultured have a lower one (2–7). Darlington

(1939) discusses this phenomenon. The preponderance of males in wild populations (Hase, 1917, 1919, and Table 38 above) may be associated with a high X-chromosome content (see also Slack, 1939) apart from being due to a differential mortality between the sexes (§ 5). Bugs with a high X content are also characterized by their large size of body and testis (Darlington, 1939).

7. ALTERNATIVE HOSTS FOR *CIMEX LECTULARIUS*

The usual host for *C. lectularius* is man, but the insect can feed and reproduce on many warm-blooded animals. Chief among these are fowls living near dwelling houses; rats, mice, guinea-pigs and rabbits may also serve as successful hosts in nature. Bats, sparrows and swallows have been recorded as hosts (Hase, 1935; Kemper, 1936). It is probable that Moens's (1925) record for *C. columbarius* on starlings really referred to *C. lectularius* (see Johnson, 1939). Animal houses attached to laboratories are not uncommonly infested, and the infestation is frequently very great indeed.

The extent to which sparrows, starlings, bats, rats or mice in dwelling houses become alternative hosts to man is not known; but judging by the scarcity of records it appears that these animals rarely support large bug populations. This is presumably due to the situation of these domestic vertebrates rather than their disadvantage as hosts, for they live in roof-spaces and under eaves and floors where bugs are not commonly found, or where in their wanderings they occur in such small numbers that there is little chance of a population becoming established before they are eaten by the hosts. Moreover, the climatic conditions under eaves are probably unfavourable for rapid breeding while the hosts are available.

I have made experiments with mice, guinea-pigs, fowls and canaries, and except for the canary have succeeded in breeding bugs on them when the association was more or less natural. When host and insect thus associate freely there is a considerable mortality among the bugs, evidently because the rodents eat them.

The discussion of alternative hosts can follow two lines:

- (1) The nutrient value of the host blood.
- (2) The relation between bug and host when they associate freely.

The first problem has already been discussed (Johnson, 1937, 1940*b*) and will be treated briefly later. It is, however, the behaviour of the bugs in the presence of the hosts rather than the nutrient value of the various bloods which makes for a successful host-bug association in nature: and it is best to deal with this section first.

We have seen (p. 360) that if bugs and mice are kept together the rate of breeding of the insects indicates that advantage is quickly taken of the host for procuring food, and that therefore the rate of development of the bugs is maximal. Let us now consider with what success a bug population may establish itself under experimental conditions.

The observations in the experimental room (see Appendix A), where hosts were guinea-pigs and fowls, have been described in various sections of this report, and some idea of the efficiency of these hosts under certain conditions may thus be gained. But other experiments with mice have yet to be reviewed.

Table 50. *Survival and development of C. lectularius in presence of mouse at 23° C. Mouse (adult except where indicated) put in each night. Baby mice up to 10-11 days old: i.e. still sucking. For details of technique see Appendix A*

| Day no. | Instars | | | | | Adults | | Day no. | Instars | | | | | Adults | |
|---------|---------|----|---------|----|---|--------|---|--------------|---------|----|-----|----|---|--------|---|
| | I | II | III | IV | V | ♂ | ♀ | | I | II | III | IV | V | ♂ | ♀ |
| 1 | 50 | — | — | — | — | — | — | 1 | 50 | — | — | — | — | — | — |
| 7 | 4 | 8 | — | — | — | — | — | 7 | 41 | 1 | — | — | — | — | |
| 14 | — | 2 | 5 | — | — | — | — | 14 | 23 | 15 | 2 | — | — | — | |
| 21 | — | — | 1 | 3 | — | — | — | 21 | 4 | 21 | 10 | — | — | — | |
| 28 | — | — | No bugs | | — | — | — | 28 | 3 | 10 | 13 | 6 | — | — | |
| 1 | 100 | — | — | — | — | — | — | 35 | 1 | 12 | 13 | 4 | — | — | |
| 7 | 10 | 41 | — | — | — | — | — | 42 | 1 | 2 | 6 | 13 | 7 | — | |
| 14 | — | 7 | 27 | — | — | — | — | 52 | — | 1 | 8 | 10 | 5 | 4 | |
| 21 | — | — | 1 | 17 | 2 | — | — | (Baby mouse) | | | | | | | |
| 28 | — | — | — | 1 | 2 | — | — | | | | | | | | |
| 35 | — | — | No bugs | | — | — | — | | | | | | | | |
| 1 | 200 | — | — | — | — | — | — | | | | | | | | |
| 7 | 10 | 67 | — | — | — | — | — | | | | | | | | |
| 14 | — | 7 | 44 | — | — | — | — | | | | | | | | |
| 21 | — | — | 3 | 13 | — | — | — | | | | | | | | |
| 28 | — | — | — | 5 | 7 | — | — | | | | | | | | |
| 35 | — | — | No bugs | | — | — | — | | | | | | | | |

Table 51. *Survival and reproduction of C. lectularius in presence of mice at room temperature. Two mice continuously in cage: details of cage in Appendix A*

| Date 1936 | Un-hatched eggs | Instars | | | | | Adults | |
|-----------|-----------------|------------------------|----|-----|----|----|--------|----------------|
| | | I | II | III | IV | V | ♂ | ♀ |
| 23. iii | — | — | — | — | — | — | 6 | 6 (not virgin) |
| 5. v | 0 | 7 | 20 | 1 | 0 | 0 | 6 | 1 (dead) |
| 22. vi | 5 | 0 | 0 | 1 | 0 | 6 | 13 | 5 |
| 17. vii | 0 | 23 | 34 | 9 | 0 | 0 | 5 | 0 |
| 19. ix | 68 | 74 | 31 | 2 | 0 | 0 | 8 | 5 |
| 22. x | 0 | 0 | 5 | 13 | 61 | 39 | 2 | 1 |
| 4. xi | 0 | 0 | 1 | 1 | 4 | 22 | 13 | 6 |
| 25. xi | — | Eggs absent and nymphs | | | | | 8 | 2 |

Eleven attempts with virgin adults at 23° C. with one, two and three pairs of adults were made; only one was successful. It started with two pairs and went on for 2½ months and the F_1 generation reproduced slightly but died out.

Tables 50 and 51 give typical results. It was uncommon for bugs to attain maturity when a single mouse was used as host and when the experiment was started with unfed first instars. If a baby mouse, up to 11 days old and still being suckled was used, many more bugs were removed, presumably because few, if any, were eaten. The most successful experiments (Table 51), when the population advanced beyond the F_1 generation, were made at room temperature with two mice in the cage. Mellanby (1939*b*) claims that rats are more active when kept singly than in pairs, and that fewer bugs are eaten by the rats if these are kept in pairs instead of singly. This may be one reason why the insect

establishes itself successfully in animal houses. My experiments at 15° C., however, were unsuccessful, and it is probable, too, that relatively high temperatures (22–26° C.) are necessary for bugs to become established on rodents: for then the reproductive rate may permit an increase in population in spite of large numbers being eaten by the hosts.

The relative values of the bloods of man, mouse, fowl and rabbit have been discussed in previous publications (Johnson, 1937, 1940*b*). Under laboratory conditions larger meals are taken from mouse (probably on account of its high body temperature) than from man or fowl, and it is this presumably which induces a relatively rapid developmental rate. Perhaps for this reason, too, more bugs reach maturity on mouse blood than on those of man or fowl when equal opportunities for feeding are given. The mouse-bred adult bugs, perhaps because of the larger meals taken, are heavier than those bred on man or fowl, and associated with this is a slight increase in fecundity.

Fasting adults and nymphs survive longest on human blood; this was associated with its higher percentage of dry matter (probably protein).

8. THE BEHAVIOUR OF BED-BUGS

A. Foreword

For the greater part of the time a bed-bug's life is spent in a state of immobility, usually in corners and cracks about a room or in furniture. This inhibition of movement, so characteristic of *Cimex*, is induced by contact stimuli; for when a bug is lying in close contact with adjacent surfaces—whether these be the sides of a crack or the bodies of other bugs—and the insects' contact receptors are sufficiently stimulated, the state of immobility is maintained until other kinds of stimuli occur to induce the bug to wander about.

A cluster of bugs ensconced in a crack may remain immobile for several weeks as the following observation shows.

Nine bed-bugs had been placed on a platform of stretched muslin in a large covered Petri dish at room temperature and 10% R.H. on 12 January 1939. They settled down in a cluster, and a piece of smoke-blackened cardboard was placed against them so that movements could be detected. A state of immobility was maintained for 35 days until overnight on 15 February they dispersed.

It is not known how long immobility can be maintained under different conditions of light, temperature and humidity, or what the actual stimuli are which induce movement. The removal of the inhibition to movement can be correlated with the temperature of the surroundings and with light; air currents and perhaps other vibrations such as those caused by people entering the room may also play a part. The internal condition of the insect, e.g. the amount of blood in its gut or the state of 'hunger', and the humidity of the environment on which loss of water from the bug so much depends may also be

important. But it is not known if these are the only possible factors or how they are co-ordinated when immobility ends and wandering commences.

When bugs emerge from their harbourages and begin to wander about they may behave in three ways:

(1) They may enter a region where the conditions cause them to orientate; this may lead them to a host or back to a place which had previously harboured bugs (see p. 432).

(2) If they enter a region where the stimuli inducing movement are absent and contact stimuli are present, they may reassume a state of immobility.

(3) They may exhibit avoiding reactions to adverse stimuli.

B. *Factors associated with the initiation of activity in a population*

No controlled experiments have ever been made in which all environmental factors except the one being tested have been kept constant. Therefore, although the movements of bugs are correlated with the factors described in the following pages, it cannot be said that they are caused by them.

(a) *Methods.*

I have kept free-living populations of *C. lectularius* in an experimental room (see Appendix A) for periods of many weeks when a host (rabbit, guinea-pig or fowl) has been both present and absent. The natural movements of bugs of the population which were correlated with room temperature were measured in two ways:

(1) Bugs have been caught in traps, from which escape was impossible, over 24 hr. periods from 11 a.m.

(2) The numbers of bugs about on the walls, ceiling and floor of the room have been counted daily at 11 a.m.

The correlation of the numbers trapped, or the numbers on the walls, etc., with temperature may be made by considering either the actual daily numbers of insects involved, or this number expressed as a percentage of the total population present in the room at the time. In the latter case allowance must be made for mortality. Bugs which died during the experiment were removed each day, and if found on the floor, or in the traps, were counted among the active insects. But when a guinea-pig or a rabbit was present some bugs were eaten and the actual number was found by counting all live bugs present at the end of the experiment and obtaining the numbers unaccounted for by the daily deaths. This procedure was unnecessary when fowl was used, for the animal was kept with a hood over the head and beak. The distribution of deaths due to the host has been unavoidably arbitrary. But several distributions have been tried with little difference to the final correlations (Table 52). Moreover, the tables and Fig. 29 setting out the data always include the correlation between temperature and the actual numbers of active bugs.

Trapped bugs were always replaced each day in the nearest harbourage (see Appendix): this conceivably introduced an error due to disturbance of the

resting bugs. Bugs sitting on the walls, ceiling and roof were not, however, disturbed, and efforts were made not to disturb harbourages by replacing bugs.

The daily difference in numbers of bugs in the room suggests a coming and going of the insects. When the numbers fell, the harbourages (and the

Table 52. *Data for movements of adult bugs in experimental room in presence of two guinea-pigs from 27. x. 38 to 7. xii. 38. Italicized figures in column 2 are numbers found dead in harbourages after periodic inspection. These, together with deaths due to guinea-pigs, have to be distributed arbitrarily*

| Date 1938 | Day | Observed deaths | Arbitrary distribution of deaths due to guinea-pigs | Probable distribution of survivors | Nos. of ♂♂ and ♀♀ on walls, floor and ceiling | No. on walls etc. as % of survivors | Mean ° C. |
|-----------|-----|-----------------|---|------------------------------------|---|-------------------------------------|-----------|
| 27. x- | 0 | — | — | 200 | 0 | 0 | — |
| 7. xii | 1 | 1 | — | 195 | 9 | 4.6 | 11.7 |
| | 2 | — | — | 191 | — | — | — |
| | 3 | 6 | 1 | 186 | 7 | 3.8 | 11.5 |
| | 4 | 2 | 1 | 179 | 20 | 11.2 | 12.4 |
| | 5 | 6 | 1 | 172 | 16 | 9.3 | 11.6 |
| | 6 | 1 | 1 | 167 | 12 | 7.2 | 12.2 |
| | 7 | — | 1 | 162 | 17 | 10.5 | 14.3 |
| | 8 | 5 | 1 | 157 | 34 | 21.7 | 16.0 |
| | 9 | — | — | 150 | — | — | — |
| | 10 | 1 | 1 | 141 | 38 | 27.0 | 15.2 |
| | 11 | 16 | 1 | 132 | 26 | 19.7 | 14.5 |
| | 12 | 1 | 1 | 128 | 27 | 21.1 | 13.4 |
| | 13 | 2 | 1 | 122 | 21 | 17.2 | 14.1 |
| | 14 | 31 | 1 | 117 | 27 | 23.1 | 14.2 |
| | 15 | — | — | 114 | 34 | 29.8 | 15.1 |
| | 16 | — | — | 110 | — | — | — |
| | 17 | 3 | 1 | 102 | 38 | 37.3 | 16.1 |
| | 18 | 15 | 1 | 97 | 33 | 34.0 | 14.9 |
| | 19 | 4 | 1 | 90 | 30 | 33.3 | 14.0 |
| | 20 | 4 | 1 | 83 | 25 | 30.0 | 14.3 |
| | 21 | 8 | 1 | 78 | 27 | 34.6 | 14.3 |
| | 22 | 3 | 1 | 73 | 27 | 37.0 | 13.5 |
| | 23 | — | — | 72 | — | — | — |
| | 24 | 5 | — | 66 | 20 | 30.3 | 11.1 |
| | 25 | — | 1 | 64 | 14 | 21.9 | 9.8 |
| | 26 | 5 | — | 63 | 15 | 23.8 | 10.5 |
| | 27 | 3 | — | 60 | 15 | 25.0 | 10.6 |
| | 28 | — | 1 | 58 | 12 | 20.7 | 10.2 |
| | 29 | 4 | 1 | 53 | 14 | 26.4 | 11.2 |
| | 30 | — | — | 52 | — | — | — |
| | 31 | — | — | — | — | — | — |
| | 32 | 1 | 1 | 50 | 9 | 18.0 | 9.2 |
| | 33 | 3 | — | 49 | 8 | 16.3 | 10.1 |
| | 34 | 1 | 1 | 47 | 5 | 10.6 | 10.0 |
| | 35 | — | 1 | 45 | 8 | 17.8 | 9.8 |
| | 36 | — | — | 44 | 7 | 15.9 | 9.5 |
| | 37 | — | — | 43 | — | — | — |
| | 38 | 1 | 1 | 40 | 9 | 22.5 | 9.6 |
| | 39 | — | 1 | 38 | 7 | 18.4 | 9.8 |
| | 40 | 6 | — | 37 | 7 | 18.9 | 10.5 |

host's cage or perch when present) were the only places into which bugs could disappear. It seems probable that bugs about in the room at 11 a.m. were mainly a residue of the numbers active on the previous night and that a periodic return to the harbourages or cage is indicated.

The room within which experiments were made is described in Appendix A. Harbourages of corrugated card were fixed, one on each of the two walls lateral to the cage or perch with the host. Six pairs of maximum and minimum thermometers were hung on the walls and were read daily. Traps were placed on the floor, one between each harbourage and the host. Mean daily temperatures in Tables 52 and 53 are means of all maximum and minimum temperatures recorded each day in the room.

Table 53. *Correlation and regression coefficients for activity of adult bed-bugs with temperature in experimental hut. Numbers active refer to number of bugs sitting on walls, floor and ceiling at 10.30–11 a.m. Number trapped refers to numbers caught in two traps during successive periods of 24 hr. Except for first experiment, males and females considered together. Temperature is mean of maximum and minimum readings on four walls of room. Means of temperature, number and percentage active are means for whole period shown by dates*

| Date 1938 | No. of obser- vations | ° C. | | Nos. active | | Corre- lation coef. | Regres- sion coef. | % active | | Corre- lation coef. | Regres- sion coef. | Remarks |
|-----------------|-----------------------------|-------|------|-------------|-------|---------------------------|--------------------------|-----------|------|---------------------------|--------------------------|-------------------------|
| | | Mean | S.D. | Mean | S.D. | | | Mean | S.D. | | | |
| Walls, etc.: | | | | | | | | | | | | |
| 1. iv–14. vi | 21 | 13.66 | 1.82 | 8.95 | 4.71 | 0.6088 | 1.5714 | 5.78 | 3.51 | 0.6009 | 1.1577 | ♂♂ only. Host absent |
| 28. x–7. xii | 33 | 12.28 | 2.15 | 18.73 | 11.08 | 0.8251 | 4.2616 | 21.18 | 8.99 | 0.4286 | 1.7964 | Two guinea-pigs nightly |
| 1939 | | | | | | | | | | | | |
| Traps: | | | | | | | | | | | | |
| | | | | No. trapped | | | | % trapped | | | | |
| 25. iv–2. vi | 23 | 15.82 | 4.11 | 1.39 | 1.76 | 0.3548 | 0.1521 | 0.72 | 0.91 | 0.3604 | 0.0798 | Host absent |
| 3. vi–6. vii | 29 | 19.37 | 2.48 | 8.03 | 9.51 | 0.7136 | 2.7396 | 5.51 | 5.95 | 0.6769 | 1.6275 | Rabbit nightly |
| 7. vii–15. viii | 32 | 20.06 | 1.08 | 7.44 | 5.01 | 0.1501 | 0.6956 | 9.49 | 6.93 | 0.0846 | 0.5418 | Fowl nightly |

(b) *Bugs about on walls, floor and ceiling and those caught in traps, in relation to temperature.*

The daily count showed that the numbers of bugs outside the harbourages or cage fluctuated (Tables 52 and 53 and Fig. 29). When the numbers fell bugs must have moved either back to the harbourages or on to the cage.

It will be seen at once that a strong and striking correlation of activity with temperature exists. The mean daily temperature used in the correlation (Table 53) was the mean of the maximum and minimum temperatures on the four walls.

The observations were made at 10.30–11 a.m. daily, and the numbers of bugs observed on the walls, floor and ceiling probably represent a residue of those bugs which were active perhaps a few hours before, during the night or in the early morning. Those caught in traps are similarly only a sample of those moving during the preceding 24 hr.

Host absent. Some movement occurs in the complete absence of a host. Only twenty-one observations were taken during a 75-day period from 1 April to 14 June 1938, but both the actual numbers and the percentage of the total population are highly and significantly correlated with temperature.

This experiment was started with 170 fed male adult bugs and 132 were present at the end. The regression coefficient shows that for every 1°C . change in temperature that part of the population on the walls changed by about 1.2%. The mean temperature during the whole period of the experiment was 13.7°C .

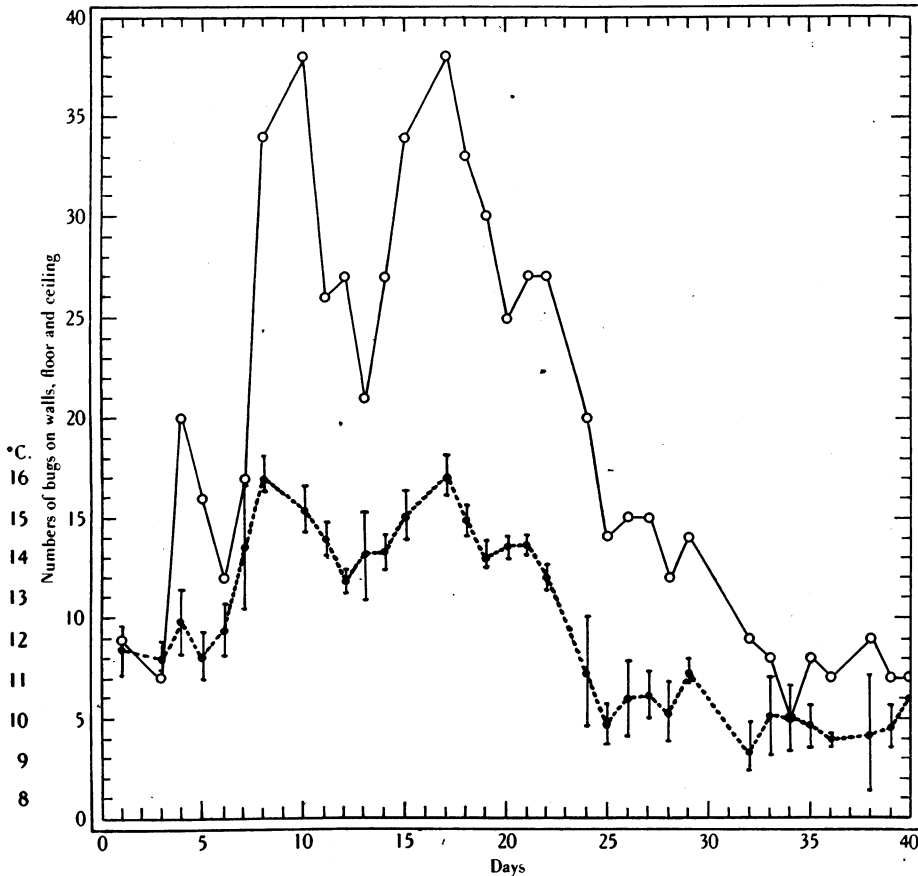

Fig. 29. Correlation of activity in experimental hut. Dotted line: mean daily temperature and vertical lines indicate mean maximum and mean minimum daily temperatures. Unbroken line: number of bugs daily on walls, floor and roof. For further details see Tables 46, 52 and 53.

In a longer experiment (Table 53 and Fig. 30), which was started with 100 fed males and 100 fed females on 25 April, very little activity was observed, and the correlation coefficients of 0.35 and 0.36 for numbers and percentages active respectively are not significantly different from zero. The mean temperature was, however, more than 2°C . higher than in the above-mentioned experiment.

Host present (Tables 52, 53 and Figs. 29, 30). The most striking correlation between temperature and proportions of bugs active in the room is seen in the

experiment run between 28 October and 7 December, when two guinea-pigs were kept continuously in the room into which were put 100 males and 100 females of *C. lectularius*. The mean temperature during the whole period was only 12.3° C. and the maximum only 16.5° C. Yet the actual numbers and the percentages active correlated with temperature (no matter how the twenty-five bugs which were eaten by the host are distributed) show correlation coefficients of 0.8251 and 0.4286 respectively: the former is significantly different from zero but the latter is barely so. The numbers of bugs present

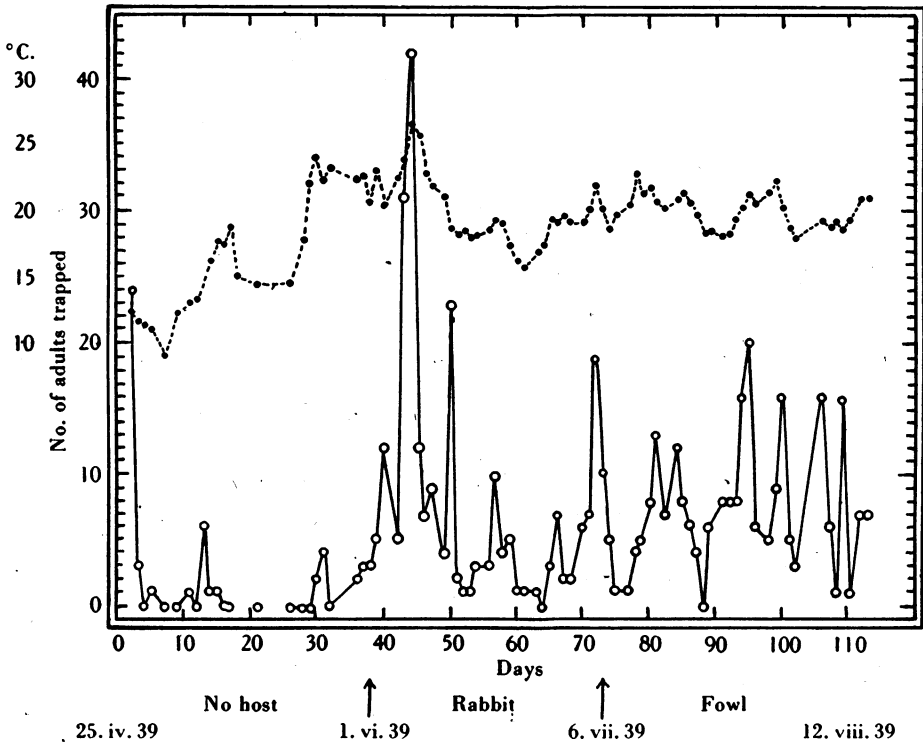

Fig. 30. Correlation of activity in experimental hut. Dotted line: mean daily temperature. Unbroken line: number of adults trapped daily. For further details see Tables 45 and 53.

in the room at the end of the experiment were thirty-six males and thirty females.

It can be seen from Fig. 29 that even slight rises and falls of 1° C. in temperature are associated with a corresponding change in the numbers on the walls, floor and ceiling. They occur, moreover, frequently and are probably not due to chance fluctuations apart from those associated with temperature.

In the experiments running from 3 April a rabbit was put into the hut (in a cage) each night and the bugs trapped. Correlation coefficients which are high and significantly different from zero are shown in Table 53. The mean temperature was 19.4° C.: there were 192 bugs present in the room at the start

(3 April) and 103 at the end of the period (6 July). The numbers seen in the room each day, although fewer than those trapped daily, follow a similar course in their relation to temperature.

When a fowl was used as host and put in each night, although both the general level of activity and the temperature were high (mean percentage trapped during the day was 9.49 and mean temperature was 20.06° C.), no correlation between activity and temperature was detected. No explanation is offered for this: perhaps continued handling and the exceptionally long period without adequate feeding were responsible. Mellanby (1939*b*) records that very starved bugs will refrain from movement, even at high temperatures unless stimulated, although this was not always my experience.

Inspection of the results of all the experiments indicates that males are slightly less active than females. Over the whole period from 28 October to 7 December, 42.4 % of all individual observations in the room (a total of 618) were for males, and from 25 April till 15 August out of 503 bugs trapped, 36.8 % were males. This is in accord with Titschack's (1930) and Jones's (1930) records that, if given equal opportunities to feed, males take fewer feeds than females (see also p. 431). In Mellanby's (1939*b*) traps, however, males were slightly more numerous, but the sex ratio of the population itself was not known. Immature stages show a similar correlation to temperature as adults. A correlation coefficient of 0.5737 which is significantly different from zero and a regression coefficient of 2.99 were obtained with immature stages (mainly unfed first instars) from 22 June till 15 August. The total number of immature stages (42) was constant during practically the whole of this time.

The threshold for movement. Many authors (see Kemper, 1936) have given 15° C. as the approximate threshold for spontaneous movement. But from Fig. 29 it is clear that it is considerably lower than this, for activity occurs between 9.5 and 11° C. Mellanby (1939*c*) observed no spontaneous movements below 11° C. but found that they occurred between 11 and 12° C. By 'acclimatizing' the insects at 14–17° C., however, Mellanby was able to induce movements in *C. lectularius* at as low a temperature as 4.5° C.

(c) *Activity in relation to light.*

Mellanby (1939*b*) trapped bed-bugs in a natural infestation in an animal house at 3-hourly intervals during May 1938. He found that the maximum number of bugs were active between 3 a.m. until just after dawn (Fig. 31). He mentions the necessity for further experiments at different times of year; his data indicate that the periodicity of activity in September was not widely different from that in May.

When a 60 W. lamp was allowed to burn all night the numbers trapped diminished considerably but activity did not cease. In fact, during the day-time it was possible to trap small numbers of bugs especially on Sundays when the animal house was not visited by men.

Thus activity is correlated with light; but it is not entirely dependent on it,

for when the animal house was kept continually in darkness for 45 hr. the catches made during the day and night resembled those made under natural conditions of daylight and darkness.

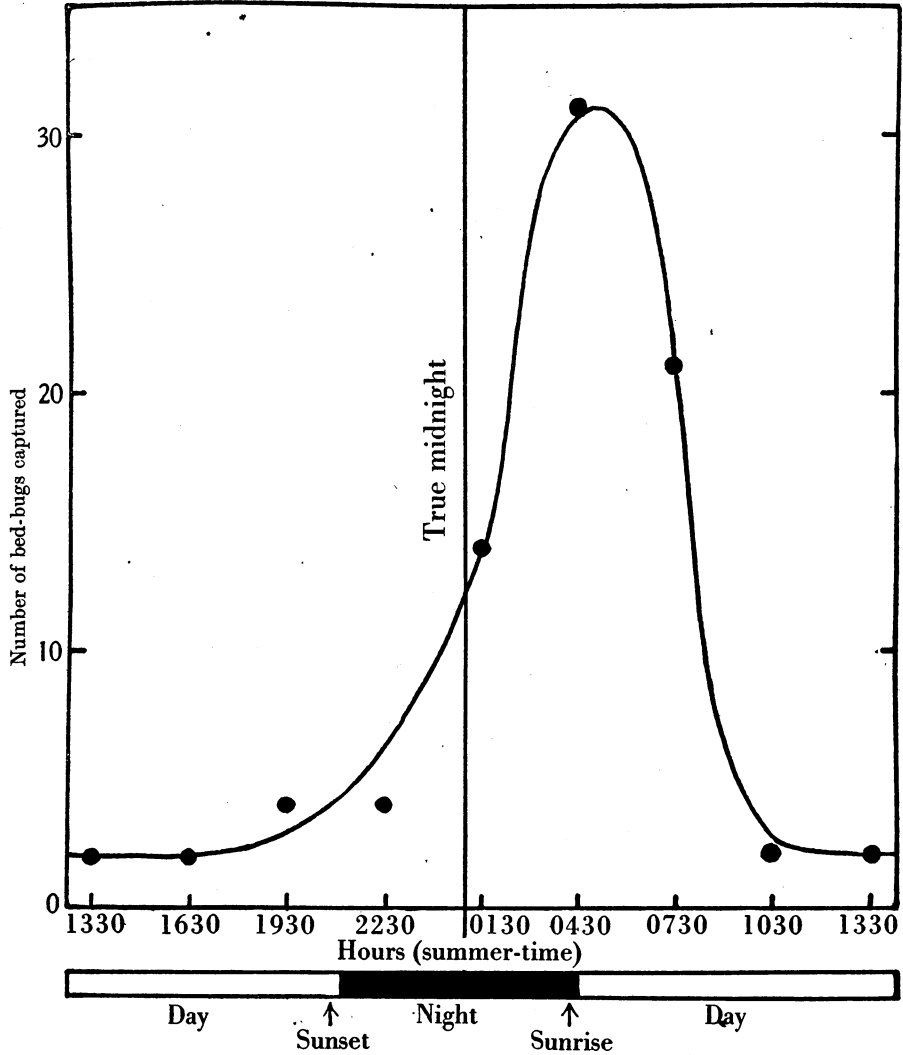

Fig. 31. Activity of bed-bugs during the day (from Mellanby, 1939b). Bugs trapped at 3-hourly intervals throughout day and night.

Mellanby concludes that an inherent rhythm governs activity in *C. lectularius*, but that it can be upset by alterations in the light factor. In these experiments it was considered that changes in temperature and humidity were not responsible for the periodicity of activity.

human host (Mellanby's room was full of caged rats) and with lower temperatures the frequency might well be considerably less than this.

C. *Orientation to stimuli*

Rivnay (1932*b*) was the first to experiment with the orientation of bed-bugs to various stimuli. He concluded that they could perceive and direct themselves towards objects 2° C. higher than room temperature from a distance of about 4 cm. He found that the odours of human sweat sometimes attracted and sometimes repelled bugs and that sebum and cerumen had a certain attractive power. The perception and orientation of bugs to these substances has not been verified: when it is attempted it will be necessary to use more modern methods than those used by Rivnay. Kemper (1929) records that beyond 2.5 cm. bugs were rarely, and beyond 4 cm. never, able to detect the presence of a human finger. Kemper could obtain no indication that bugs were attracted to human sweat.

The perception of warmth by *C. lectularius* has been studied recently by Sioli (1937). He found that when bugs were allowed to wander at random in an experimental chamber containing a source of heat a difference in temperature higher than the surroundings of 1° C. could be detected: differences of 0.5° C. induced no reaction. This perception of warmth was shown at all environmental temperatures between 27.8 and 15° C. Below 15° C. the bugs became too sluggish for successful experiment. Sioli found that the receptor organs were localized in the antennae. It seems probable that, as with *Rhodnius* (Wigglesworth & Gillett, 1934), bugs perceive the warmth of the air and not radiant heat, but this has not yet been demonstrated. As far as Sioli's experiments went, they showed the behaviour of *Cimex* and *Rhodnius* to be very similar. In *Rhodnius* vibration and vision may be accessory factors in the elicitation of response to a host: the role of these factors in *Cimex* is unknown.

In conclusion, it is evident that a bed-bug may perceive and orientate itself towards a host only within a distance of a few centimetres.

There is frequent mention in the literature on *Cimex* that it may return to its hiding place, sometimes retracing its tracks for considerable distances: little precise information exists on this point. From my preliminary experiments it appears that places where bugs have previously rested and where excrement is present are attractive to bed-bugs. When they are given a free choice of many apparently similar crevices only one of which had previously harboured bugs and which contained excrement, bugs dispersed over an area of about 300 sq. cm. will eventually congregate at the place previously occupied by bugs. If such an attraction actually exists an active bug may keep to a track (e.g. along the edge of a wall) which had been fouled by bugs. And bugs may even congregate in the same harbourage repeatedly for the same reason, especially if it is the only one in the immediate vicinity of the host. There is no evidence to suggest that, with a choice of such harbourages the same bugs would always

frequent the same harbourages. Neither is there any evidence to suggest that by keeping to the same track or using one harbourage continually bugs have a memory for places or that it shows 'intelligence' (Kemper, 1929).

Bugs dislike wet surfaces (Hase, 1917) and they will not settle in damp places (Kemper, 1936). Nothing is known about their reactions to atmospheric humidity, or their 'preference temperatures'. Bright light (70-100 f.c.) is avoided, and if given a choice between light and shade the bug will turn until it has entered the shade and will then usually settle down (Kassianoff, 1936; Johnson, MS.). Once a state of immobility has been assumed, direct light, even of 200 f.c., will usually fail to induce movement. The statements of Janisch (1933), Martini (1923) and Kemper (1936) that bugs sit in each other's shade can scarcely be true: the clustering of bugs against each other is a thigmotactic response. Kemper's (1936) statement that bugs range themselves together according to the different developmental stages may be due (if it really occurs) to small or large bugs fitting more closely with others of the same size.

The whole subject of bed-bug behaviour lacks precise data obtained from adequately controlled experiments: and it will most likely be found that the conditions under which a bug has been kept affect its subsequent behaviour profoundly (Wigglesworth, 1941, on *Pediculus*).

II. DEDUCTIONS ON THE STATE OF POPULATIONS THROUGHOUT THE YEAR

Part I of this report summarizes knowledge of various aspects of bed-bug biology but does not give a general picture of the natural history of the insect throughout the whole year: it is to the latter which we now turn.

Accurate, quantitative data on bed-bug life observed in houses are almost non-existent, and the only course open at present is to attempt to synthesize the separate factors studied in the laboratory, and described in Part I of this report, into a general account of possible happenings to a population under natural conditions. The accuracy of a picture made by such a deductive method must be regarded with great suspicion: but some of the apparently master factors are brought forward and a definite role assigned to them. Such a synthesis must be regarded as tentative and merely as the prelude and basis of future quantitative field work.

The following deductions have been worked out on a quantitative basis: but the complexities of the problem and our ignorance of certain major aspects of bed-bug behaviour have made certain assumptions necessary. Consequently the picture is possibly very inaccurate quantitatively, but it will yield to future modification towards greater precision along lines which would be less obvious from a purely qualitative treatment.

The bed-bug seems to be one of those insects where fluctuations of its

populations depend, apart from the influence of man, largely on climate. We have seen that environmental temperature is probably the most important climatic factor and humidity can, for the moment, be disregarded. We must build our picture, therefore, against a background of house temperatures.

Let us consider a room in which the temperature follows a course similar to that in the bedroom at 50 Oakworth Road and on the ground, first and second floors at 54 Palace Gardens Terrace, London (Figs. 2 and 3). For convenience of working let us approximate by dividing each month into 4 'weeks' of 8 or 7 days each and by taking the mean 'weekly' temperatures using as a basis for estimation the mean values for 5-day periods from the record of the two houses (Johnson, 1938).

We can work out the happenings to a small population of bugs in such a room as that at 50 Oakworth Road and consider tentatively that a similar sequence of events would have occurred in an unheated London bedroom of the same type in 1935-6.

We know from § 6 that in London overwintered bed-bug populations consist of adults and the later nymphal stages and that only a relatively small proportion (from 12 to 40%) of the adult females are fertilized (Table 38).

Let us start therefore with a small population of forty adult bugs, two fourth and five fifth instar nymphs (for constitution of overwintered populations see § 6). We assume that there are twenty adult females (see Table 38) of which 25% (five bugs) are fertilized and capable of producing eggs soon after feeding and without having to copulate. Then some time after the temperature rises sufficiently for these bugs to seek and procure a blood-meal oviposition will commence.

It is necessary, first of all, to consider when feeding will start and with what frequency it will continue. This knowledge is very vital if we are to follow the subsequent growth of the population, for, as we have seen (p. 383), the frequency of feeding has a considerable effect on the output of eggs. Unfortunately, exceedingly little is known about the frequency with which bugs wander about at different temperatures when meals are taken regularly. And the exact position of the host in a room may affect the frequency with which it is found and meals are taken, even if other factors are known. We are forced, therefore, to begin with inadequate data and to assume that the bugs we are considering live close to the host and always find it without undue waste of time. Then we arbitrarily fix the frequency with which feeding occurs in accordance with our knowledge summarized in § 8 (*d*).

Consider a normal individual adult female which fed once at the beginning of each week that I have indicated in column 6 of Table 54. The first feed is assumed to be taken when the temperature rises to 16° C. (60.8° F.) in the second week of May, and thenceforward a feed is taken once a fortnight until August when, the temperature ranging from 21 to 24° C., she feeds once a week. The fortnightly intervals are again resumed as the temperature drops and feeding ceases after October. It is possible, of course, that some feeding occurs

during the winter, but eggs would not be laid since the temperature is below the ovipositional threshold (p. 387).

Table 54. *Hypothetical data for F_1 generation on frequency of feeding, egg production and percentage hatch of eggs from a small overwintered population of twenty male and twenty female adults, two fourth instars, and five fifth instars in a room similar to that at 50 Oakworth Road (see temperature chart on Fig. 2). A, B, C, and D of column 7 are those sections of the adult population which remain fertilized (A) after the winter fast and (B, C and D) those which become impregnated during the following spring*

| Months and 'weeks' | Days per 'week' | Mean 'weekly' temp. ° C. ° F. | | Meals per ♀ | Eggs per ♀ per meal | | | | Total eggs per 20 ♀♀ (overwintered) with some allowance for scatter of feeding | Total eggs from adults of overwintered nymphs | Approx. % hatch |
|--------------------|-----------------|-------------------------------|---------|-------------|---------------------|---|---|---|--|---|-----------------|
| | | | | | A | B | C | D | | | |
| April | 1 | 8 | 10 50.0 | — | — | — | — | — | — | — | |
| | 2 | 7 | 9 48.2 | — | — | — | — | — | — | — | |
| | 3 | 8 | 10 50.0 | — | — | — | — | — | — | — | |
| | 4 | 7 | 13 55.4 | — | — | — | — | — | — | — | |
| May | 1 | 8 | 14 57.2 | — | — | — | — | — | — | — | |
| | 2 | 8 | 16 60.8 | 1 | — | — | — | — | — | — | |
| | 3 | 8 | 17 62.6 | — | 3 | 0 | 0 | 0 | 3 | 80 | |
| | 4 | 7 | 18 64.4 | 1 | — | — | — | — | 12 | 85 | |
| June | 1 | 8 | 16 60.8 | — | 3 | 0 | 0 | 0 | 10 | 85 | |
| | 2 | 7 | 19 66.2 | 1 | — | — | — | — | 20 | 90 | |
| | 3 | 8 | 21 69.8 | — | 3 | 0 | 0 | 0 | 60 | 90 | |
| | 4 | 7 | 23 73.4 | 1 | 5 | 5 | 5 | 5 | 30 | 90 | |
| July | 1 | 8 | 20 68.0 | — | — | — | — | — | 70 | 85 | |
| | 2 | 8 | 19 66.2 | 1 | — | — | — | — | — | — | |
| | 3 | 8 | 19 66.2 | — | 3 | 3 | 3 | 3 | 60 | 90 | |
| | 4 | 7 | 20 68.0 | 1 | — | — | — | — | — | — | |
| Aug. | 1 | 8 | 21 69.8 | — | 4 | 4 | 4 | 4 | 80 | 90 | |
| | 2 | 8 | 24 75.2 | 1 | 5 | 5 | 5 | 5 | 80 | 90 | |
| | 3 | 8 | 21 69.8 | 1 | 4 | 4 | 4 | 4 | 52 | 90 | |
| | 4 | 7 | 22 71.6 | 1 | 4 | 4 | 4 | 4 | 80 | 90 | |
| Sept. | 1 | 8 | 19 66.2 | — | — | — | — | — | 48 | 85 | |
| | 2 | 7 | 18 64.4 | 1 | — | — | — | — | — | — | |
| | 3 | 8 | 18 64.4 | — | 3 | 3 | 3 | 3 | 60 | 80 | |
| | 4 | 7 | 18 64.4 | 1 | — | — | — | — | — | — | |
| Oct. | 1 | 8 | 15 59.0 | — | 3 | 3 | 3 | 3 | 12 | 9 | |
| | 2 | 8 | 15 59.0 | — | — | — | — | — | 48 | — | |
| | 3 | 8 | 15 59.0 | 1 | — | — | — | — | — | — | |
| | 4 | 7 | 13 55.4 | — | — | — | — | — | — | — | |
| Nov. | 1 | 8 | 14 57.2 | — | 2 | 2 | 2 | 2 | 40 | 6 | |
| | 2 | 7 | 12 53.6 | — | — | — | — | — | — | — | |
| | 3 | 8 | 10 50.0 | — | — | — | — | — | — | — | |
| | 4 | 7 | 10 50.0 | — | — | — | — | — | — | — | |

Now if a population of adult females is considered, all may succeed in obtaining blood at regular intervals during the summer. But as the temperature drops, progressively smaller proportions of the population will feed successfully since fewer bugs will wander about. Also, even if they all find food when the temperature is high they would be unlikely all to find it on the same day. Thus when considering the feeding of a population we must assume that where I have indicated a meal to be taken (col. 6) the feeding of the population

is spread over that week. Moreover, simplification is necessary at the present stage, and we may also assume that *all* the females feed some time during the week indicated.

Obviously, here are very important lacunae in knowledge which, at the outset, show how tentative any synthesis of factors must be at this stage. We now proceed to calculate by the following method when eggs will be laid.

From Table 7 and Fig. 7 we see that 5.38 days elapse at 23° C. between feeding and oviposition of the first egg. Therefore 1/5.38th of this time will have passed in 1 day. By plotting the reciprocals of the times between feeding and oviposition at different temperatures against temperature we can find what percentage of the total time at any temperature 1 day represents. If a number of days are passed by a female at different temperatures after feeding we simply add up the reciprocals for the time at each daily temperature and the day on which unity is attained will be the day for oviposition.

Suppose an overwintered female feeds at the beginning of the first day on the second week in May, the first egg will be laid on the seventh day of the third week in May and so on (col. 7 A, Table 54). If all the fertilized overwintered females feed on *successive* days in the second week in May, each female will commence oviposition at successively later dates following the seventh day of the third week in May. But actually all the eggs which a female produces are not laid on the one day but are spread over several days (Fig. 14). Thus times of egg laying will be scattered over several days owing to the feeding of females and the distribution of oviposition over successive days. At the present stage of approximation, however, when so many factors are given arbitrary values, it is sufficient to assume that all eggs will be laid during the week following the day on which oviposition commenced, as calculated from a feed taken at the beginning of that or a previous week (col. 7 A, Table 54).

Thus for that quarter of the overwintered adult female population (col. 7 A) we have assumed to be fertilized an estimate is made of the commencement of oviposition. Suppose that the remaining three-quarters of the adult female population (col. 7 B, C, D) are impregnated later on. It is probable that this will have been accomplished by the second week in June (see § 4 C (*d*)), and that the first eggs will have been laid by the last females to be mated by the third week in June. This estimation, however, is extremely arbitrary, and even if we knew the copulation rate at temperatures between 15 and 23° C. much will depend on the chances of females and males meeting in nature.

We now proceed to estimate how many eggs each female lays after feeding at the different temperatures. We have seen (§ 4) that the output of eggs per female is somewhat variable even if the temperature, weight of female and atmospheric humidity are known, and the estimated egg numbers in Table 54 are probably considerably less than those which would be laid, especially during the summer. Correction for this can be made, however, by multiplying the subsequent calculations by an appropriate quantity.

Columns 8 and 9 in Table 54 give the total weekly egg output for the whole

overwintered female population. Oviposition is probably distributed more evenly than I have indicated. But it seems idle to carry refinements too far in the present stage when so much is arbitrary. We can do no more than indicate possible tendencies at present.

The growth of the future population depends very much on the frequency of feeding and on the output of eggs per female per feed. Both these factors will be much influenced by the distance between bug harbourages and the host, for, apart from the success with which the host is found, the more reserve in the blood-meal used by active wandering the less will be left for egg production. These aspects of bug behaviour deserve critical work in the future. Their relations in the general ecology of the bug are brought forward here although data on them are lacking.

Having made an admittedly arbitrary basis for future population growth by stating the feeding frequency and the egg production, we can now deduce the rate of development and the approximate proportions of bugs which are likely to reach maturity. First of all the hatching time is found by the use of the reciprocals of the time from oviposition to hatching (data in Table 2 and Fig. 6). The method is the same as that already used for estimating the time at which the first eggs are laid after a blood-meal. Reciprocals of the duration of the egg stage have been plotted against temperature and the values for intermediate temperatures found by interpolation. The reciprocal values are based on *mean* hatching times so that the estimated hatching date will also be an average value. In nature there would be a scatter of hatching times around this mean time, and thus first instar nymphs will appear in a smoother sequence than indicated in Table 54. However, we are considering the population from week to week, and this rather coarse unit of time indicates only tendencies of actual happenings. The same applies to all subsequent moultings.

When the mean hatching time has been found we can also estimate the mean temperature of incubation. Then, knowing also the temperature of oviposition, an estimation of the percentage hatch can be made from Fig. 10. Table 38 shows that eggs produced from overwintered female adults suffer about a 10% mortality when laid and incubated under optimal climatic conditions: this is about the same mortality shown by laboratory cultures (Table 12) on which Fig. 10 is based. Column 10 of Table 54 indicates the percentage hatch which would be expected in nature. Column 4 of Table 55 gives the mean date of the appearance of first instar nymphs and their numbers. It will be noticed that the mortality of eggs is considered to be very high if they are *laid* at 15 and 16° C. and incubated at or below these temperatures.

The mean moulting times of all the nymphal stages are now estimated, assuming that bugs find the host soon after moulting without an undue waste of time and that they all feed successfully. As pointed out in § 3 B, we can easily find the periods between feeding and moulting at different temperatures. But it is conjectural how much time is spent between moulting and feeding. An arbitrary prefeeding period has been given for each temperature based on

the data presented in § 3 B. I have considered that the following prefeeding periods elapse at the various temperatures, and that they are the same for all nymphal stages and adults of the next generation:

| ° C. | ° F. | Prefeeding period days |
|------|------|---------------------------|
| 25 | 77.0 | 2 |
| 23 | 73.4 | 3 |
| 18 | 64.4 | 5 |
| 15 | 59.0 | 10 |

These periods have been added to the corresponding periods between feeding and moulting (see Table 3). The reciprocals of the following intervals can now be plotted and values for intermediate temperatures found by interpolation: these values are of course based on mean developmental times.

Oviposition to hatching

| | |
|---|-----------------------------|
| „ | first moult (second instar) |
| „ | second moult (third instar) |
| „ | third moult (fourth instar) |
| „ | fourth moult (fifth instar) |
| „ | fifth moult (adult) |

For example, for oviposition to third moult:

| ° C. | Mean times for oviposition-hatching | First instar | Second instar | Third instar | Total | Pre-feeding periods × 3 | Mean time oviposition-third moult days | Reciprocal |
|------|-------------------------------------|--------------|---------------|--------------|-------|-------------------------|--|------------|
| 23 | 9.2 | 5.2 | 5.3 | 5.3 | 25.0 | 9 | 34.0 | 0.0294 |
| 18 | 20.2 | 11.2 | 12.0 | 13.1 | 56.5 | 15 | 71.5 | 0.0140 |
| 15 | 34.0 | 21.2 | 24.2 | 24.5 | 103.9 | 30 | 133.9 | 0.0075 |

This method of using the reciprocal has been adopted generally in this report: it is the best method for such approximations. Its theoretical soundness has been discussed elsewhere (Johnson, 1940*a*).

Since the estimates for moulting times are based on mean values it is best to regard moulting as taking place throughout the whole week in which it is indicated. Actually there will be an overlap of moults from week to week, but I have not considered it justified to make this refinement.

The mortality among nymphs in nature, apart from that caused by man, must vary considerably from place to place and would probably be higher in situations where the host is not quickly found. I have assumed, however, that as long as the prefeeding and postfeeding periods were spent above 16° C. (see § 3 D) mortality is nil. When the prefeeding and postfeeding periods have been spent at 16° C. or lower only 15–20% of the bugs which feed will moult at 15° C. and probably even less as the moulting threshold (13° C.) is approached (see Tables 16 and 17).

Thus, under our arbitrary conditions, F_1 adults would first appear during the second week in August and would continue to be produced until the second or third week in October, after which the temperature falls below the moulting threshold.

The frequency with which the adults of the first filial generation feed can be fixed on the basis of the feeding frequency of the parents. Then if they all mate during the first day or two after feeding we can easily estimate the date and also the number of eggs produced. The weather would be warm when adults are produced in August and September, and the chances of a very high proportion of them mating without much delay is probably large. This is a point, however, on which data are lacking (see § 4 C (d)). Only small proportions however of the adults which moult during October probably mate. *But from the point of view of increase in numbers of actual bugs this is likely to be immaterial.*

Table 55. *Oviposition, hatching and moulting times of progeny from overwintered adults and nymphs from room similar to that at 50 Oakworth Road*

| Months and 'weeks' | F_1 | | | | | | | F_2 | | | | |
|--------------------------|-------|----|----|--------|----|----|--------|-------|-----|--------|-----|----|
| | Eggs | I | II | Nymphs | | | Adults | Eggs | I | Nymphs | | |
| | | | | III | IV | V | | | | II | III | IV |
| May | 1 | — | — | — | — | — | — | — | — | — | — | — |
| | 2 | — | — | — | — | — | — | — | — | — | — | — |
| | 3 | 3 | — | — | — | — | — | — | — | — | — | — |
| | 4 | 12 | — | — | — | — | — | — | — | — | — | — |
| June | 1 | 10 | — | — | — | — | — | — | — | — | — | — |
| | 2 | 26 | 2 | — | — | — | — | — | — | — | — | — |
| | 3 | 63 | 19 | 2 | — | — | — | — | — | — | — | — |
| | 4 | 45 | 80 | 19 | — | — | — | — | — | — | — | — |
| July | 1 | 70 | — | 23 | 12 | — | — | — | — | — | — | — |
| | 2 | — | 41 | 57 | 9 | 2 | — | — | — | — | — | — |
| | 3 | 69 | 60 | 41 | 23 | 10 | — | — | — | — | — | — |
| | 4 | — | — | — | 57 | 32 | 2 | — | — | — | — | — |
| Aug. | 1 | 92 | 62 | 60 | 41 | 57 | 19 | — | — | — | — | — |
| | 2 | 95 | 83 | 62 | 60 | 41 | 80 | 21 | — | — | — | — |
| | 3 | 64 | 86 | 83 | 62 | 60 | 41 | 23 | 40 | — | — | — |
| | 4 | 92 | — | — | — | 62 | 60 | 57 | 84 | — | — | — |
| Sept. | 1 | 48 | 58 | 86 | 83 | — | — | 41 | — | 36 | — | — |
| | 2 | — | 83 | — | — | — | — | — | 87 | 75 | — | — |
| | 3 | 69 | — | 58 | 86 | 83 | 62 | 60 | 123 | — | 36 | — |
| | 4 | — | 41 | 83 | — | — | — | — | 6 | — | 75 | — |
| Oct. | 1 | 21 | — | — | 58 | — | — | — | 294 | 74 | — | 36 |
| | 2 | 48 | 55 | — | — | 86 | 83 | 62 | 6 | 82 | — | — |
| | 3 | — | — | 41 | — | — | — | — | — | 4 | — | — |
| | 4 | — | — | — | 83 | 9 | — | — | — | — | 14 | 75 |
| Nov. | 1 | 46 | — | — | — | 1 | — | 1 | 250 | — | 5 | — |
| | 2 | — | — | — | — | — | 15 | — | 2 | — | — | — |

For even if they all mated, of the eggs laid at temperatures at and below 15° C., only a very small proportion (less than 5%) would hatch (Fig. 10). Moreover, the first instars from these eggs would probably never feed before the temperature dropped below the threshold for movement.

Thus, although the threshold for hatching and moulting may be as low as 13° C. with organisms from cultures at 23° C., oviposition and prefeeding periods at 15° C. render changes in the population improbable below 15° C. The rate at which the temperature drops is obviously an important factor governing egg mortality in the autumn.

From eggs laid by the F_1 adults we again estimate the percentage hatch and moulting times as before (Table 55).

We can now make a table which gives us an approximate estimation of the sequence of events and the proportions of the various stages in the population from week to week.

Consider the offspring of both F_1 and F_2 generations produced from overwintered nymphs and adults. We put down in a column opposite the appropriate dates the weekly number of eggs produced. Then we do the same for each instar and for adults using the data from Table 55. We now get the

Table 56. *Progeny present from week to week, e.g. 50 Oakworth Road. F_1 and F_2 generations from overwintered adults and nymphs. Italicized figures are percentages to nearest whole number based on total progeny for that week. Absence of larval mortality is assumed*

| Months and 'weeks' | Eggs (unhatched) | Nymphs | | | | | Adults | Total progeny | Total blood-sucking bugs |
|--------------------|------------------|--------|--------|--------|-------|--------|--------|---------------|--------------------------|
| | | I | II | III | IV | V | | | |
| May 1 | — | — | — | — | — | — | — | — | — |
| 2 | — | — | — | — | — | — | — | — | — |
| 3 | 3 100 | — | — | — | — | — | — | 3 | — |
| 4 | 15 100 | — | — | — | — | — | — | 15 | — |
| June 1 | 25 100 | — | — | — | — | — | — | 25 | — |
| 2 | 49 96 | 2 4 | — | — | — | — | — | 51 | 2 |
| 3 | 93 82 | 19 17 | 2 2 | — | — | — | — | 114 | 21 |
| 4 | 58 36 | 80 50 | 21 13 | — | — | — | — | 159 | 101 |
| July 1 | 128 56 | 57 25 | 32 14 | 12 5 | — | — | — | 229 | 101 |
| 2 | 87 38 | 41 18 | 80 35 | 19 8 | 2 1 | — | — | 229 | 142 |
| 3 | 96 32 | 60 20 | 98 33 | 32 11 | 12 4 | — | — | 298 | 202 |
| 4 | 96 32 | 60 20 | 41 14 | 57 19 | 42 14 | 2 1 | — | 298 | 202 |
| Aug. 1 | 126 32 | 62 16 | 60 15 | 41 11 | 80 21 | 21 5 | — | 390 | 264 |
| 2 | 138 28 | 83 17 | 62 13 | 60 12 | 41 8 | 80 16 | 21 4 | 485 | 347 |
| 3 | 156 26 | 86 15 | 83 14 | 62 11 | 60 10 | 98 17 | 44 7 | 589 | 433' |
| 4 | 332 43 | 86 11 | 83 11 | 0 0 | 62 8 | 101 13 | 101 13 | 765 | 433 |
| Sept. 1 | 286 35 | 94 12 | 86 11 | 83 10 | 62 8 | 60 7 | 142 17 | 813 | 527 |
| 2 | 215 24 | 252 28 | 86 10 | 83 9 | 62 7 | 60 7 | 142 16 | 900 | 685 |
| 3 | 407 37 | 158 14 | 94 9 | 86 8 | 83 8 | 62 6 | 202 19 | 1092 | 685 |
| 4 | 372 34 | 41 4 | 252 23 | 86 8 | 62 6 | 62 6 | 202 18 | 1077 | 705 |
| Oct. 1 | 513 39 | 115 9 | 158 12 | 180 14 | 83 6 | 62 5 | 202 15 | 1313 | 800 |
| 2 | 420 31 | 262 19 | 158 12 | 94 7 | 86 6 | 83 6 | 264 19 | 1367 | 947 |
| 3 | 416 30 | 225 16 | 199 15 | 94 7 | 86 6 | 83 6 | 264 19 | 1367 | 951 |
| 4 | 416 30 | 211 15 | 55 4 | 236 17 | 102 7 | 83 6 | 264 19 | 1367 | 951 |
| Nov. 1 | 712 43 | 206 12 | 60 4 | 235 14 | 103 6 | 82 5 | 265 16 | 1663 | 951 |
| 2 | 714 43 | 206 12 | 60 4 | 235 14 | 88 5 | 97 6 | 265 16 | 1665 | 951 |

running totals from each column and place these by the side of the weekly layings and moultings. Then to obtain the number of unhatched eggs in any week we subtract the running total of first instars in that week from the running total of eggs for the same week. Similarly, in order to find how many first instar nymphs exist in any week we subtract the running total of second instars from the running total of first instars of that week. Adults of course will be represented each week by the running total alone.

We do this for every week of the year and obtain the proportions of the eggs, the various nymphal stages and adults existing each week (Table 56). These can be expressed as percentages of the total number of organisms in that week (Fig. 32). The percentages thus obtained of the different nymphal stages

might be expected to be very inaccurate, since we have not allowed adequately for scatter of moulting times and our working period of 7 or 8 days is very coarse. But the relative proportions of eggs, adults and all nymphal stages at least are probably very similar to the state of affairs under similar environmental conditions in nature where bugs have no difficulty in finding the host. The results of Mellanby (1939*b*), however, set out on p. 419, indicate that in an actually breeding and moulting natural population the proportion of the various nymphal stages and adults are very similar to that postulated in the above scheme (cf. August–September in Fig. 32 with Mellanby's figures on p. 419). This assumes, of course, that all stages were trapped in the proportions in which they existed in the population which Mellanby describes.

Throughout this scheme of population increase I have assumed that no nymphal or adult mortality occurs. The difficulties of estimating the effects of

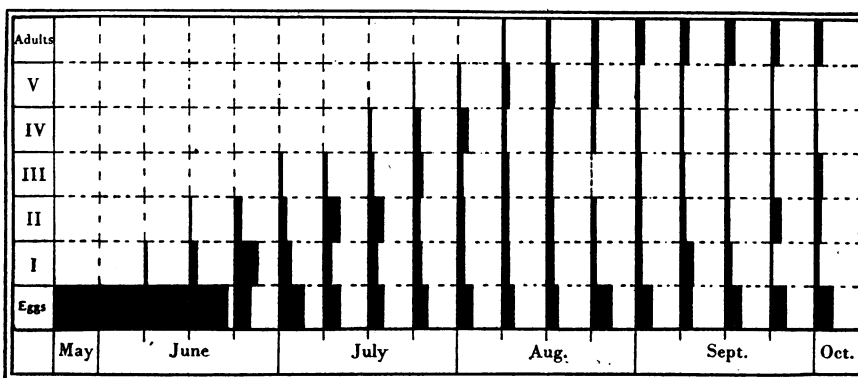

Fig. 32. Hypothetical scheme of population growth in a room similar to that at 50 Oakworth Road. Black areas represent proportions of various stages, as percentages of total progeny. Abscissa for each week represents 100%. See Tables 54, 55 and 56.

adult age and mortality on egg production at variable temperatures are very considerable even if we knew much about them; and we know little.

Let us now consider the fate of the organisms existing at the middle of November. The temperature drops as winter progresses, so that hatching, moulting, mating and oviposition cease. Some feeding may occur during the winter, but it is doubtful if large proportions of the bugs take repeated blood-meals, especially if they are in harbourages some distance away from the host.

It is explained in § 5 how varied the mortality of free-living populations and of laboratory cultures may be: at this stage the course of mortality of bed-bugs which are free to move about a room and to feed is quite unpredictable. Thus it is impossible yet to estimate accurately how many bugs alive in November survive the following winter unimpaired and capable of further development and reproduction in the spring.

It is probable that some of the original overwintered parents from which

our hypothetical population was derived survived until November. I have assumed for the sake of simplicity that they all died at the same time after the last eggs were laid in November. But it is certain that some would have died before this, for they would already be old bugs when they commenced activities in the spring. Conjecture on the fate of their progeny is, however, profitable. Let us suppose that the winter period is approximately 180 days from the beginning of November until the end of the following April, and that the mean temperature is approximately 9° C. (48.2° F.).

Eggs. Eggs laid during October, at 15° C., probably do not hatch. They would not survive the winter (§ 3 C) as suggested by Gunn (1933).

First and second instars. Starvation of first instars would actually begin in October since few moult during that month. Thus the starvation period would be approximately 210 days. If first instars do not feed during the winter it is improbable that more than one or two would survive till April even if the humidity was optimal for survival (75–90 % R.H.) (Table 42 and Figs. 26 and 27). We do not know what the relative humidity around the bugs may be; it is probably not often as high as 75 %. Free-living bugs, moreover, have a higher mortality rate than those kept under the laboratory conditions as in Table 42.

The same applies to unfed second instars (Table 43), although if the humidity is high a greater proportion of second than first instars would be expected to survive the winter (Figs. 26 and 27).

Third and fourth instars. These stages live longer than first and second instars under comparable conditions (p. 413). The later stage survives the longer.

Fifth instars and adults: These stages, under the same conditions, live longer than any of the others. Kemper's (1930) data (p. 413) indicated that adults live about as long as fifth instars. With adult bugs fed once and then starved, males tend to outlive females except at very low temperatures. The same applies to mass cultures at 23° C. when feeding and full reproductive activities proceed regularly. Unmated females, however, live longer than other adults under the same conditions.

Thus in a population of adults at the end of a winter's fast, the proportions of unmated females and males (virgin and mated) would be expected to have increased: and in actual fact most of the females are virgin and adult males are more common than females.

• It is quite impossible to estimate confidently the proportions of adults or nymphs which survive the winter. We would expect, however, that the surviving population would consist of adults, fifth, fourth and third nymphal instars, with the stages predominating in that order: and this, as we see in § 6, is the usual state of affairs. We would expect, moreover, to find more males than females, if the sex ratio was 50 % in November. If, in November, fertilized and virgin females existed in equal numbers, then in April the numbers of virgins would predominate. In the scheme outlined in Tables 54 and 55 I have assumed that all the females produced up till mid-October become fertilized.

This is probably not so, and from September onwards many females may fail to mate. Thus we could not say what proportions of the survivors might be virgin or otherwise even if we had accurate knowledge of the mortality of free-living populations.

Suppose, however, that all the females were fertilized by October. Tables 54 and 55 show that all adults which are about to overwinter commence to fast (assuming that little feeding occurs in winter) from about mid-October—approximately 200 days of fasting till the end of April. If all the adults were freshly moulted in November (and actually many are already several weeks old) we can estimate the order of the mortality during the winter from Figs. 20–24 and 28. Fig. 24 shows what is probably a minimal mortality rate: in a free-living population the rate is probably much higher (Fig. 28). Thus if the humidity in a room was low, it would be quite within the limits of expectation if no more than 20% of the adults present in November survived till the end of April. Thus 20% of 265 is 53: and we started with only 40. The surviving nymphs would be proportionately represented.

Thus in a room such as we have considered even though a population of the blood-sucking phases of the insect may increase from 47 to 951, i.e. by more than twenty times, it would not be highly improbable to expect a reduction to a density very similar to that of the preceding spring if humidity and temperature were sufficiently below the optimal for survival and if some activity proceeded. Even if many more than 265 adults commence to overwinter, the depletion of the population due to death in winter must be very considerable.

However, humidity, activity and feeding frequency are likely to have a very considerable influence on the numbers surviving the winter. But we did not allow for any nymphal mortality or mortality of adults during the warmer months of the year. This latter will influence the increase in the population: but we know little about mortality under these conditions, and if we did the difficulties of allowing for it in such a scheme as this are very considerable.

All bedrooms, however, do not show a temperature chart like that from 50 Oakworth Road. In London and other cities there are many large blocks of flats, and bedrooms in these, even if unheated, may have a higher yearly temperature than bedrooms in ordinary houses, chiefly because the winter temperatures are higher (Figs. 2, 3). Bed-sitting rooms in ordinary houses may also have similar high winter temperatures. For example, in an unheated bedroom in Sutton Dwellings and in bed-sitting rooms in Wornington Road, the lowest mean monthly temperatures fall only slightly below the developmental-hatching, moulting and ovipositional thresholds (12–13° C.; 53.6–55.4° F.). Most of the wild populations described in §§ 4 and 6, moreover, were gathered from similar rooms (Tables 38 and 48).

A hypothetical scheme of population growth (Tables 57–59) in such rooms has been made by using a similar basis of feeding frequency and egg production in relation to temperature as that in the scheme for 50 Oakworth Road. Let us consider the possible happenings in a room like that at Sutton Dwellings

Table 57. *Hypothetical data for F₁ generation on feeding frequency, egg production and percentage hatch of eggs from overwintered population, e.g. Sutton Dwellings. For further description see Table 54*

| Months and 'weeks' | Days per 'week' | Mean 'weekly' temp. ° C. ° F. | | Meals per ♀ | Eggs per ♀ per meal | | | | Total eggs per 20 ♀♀ (overwintered) with some allowance for scatter of feeding | Total eggs from adults of overwintered nymphs | Approx. % hatch |
|--------------------|-----------------|-------------------------------|---------|-------------|---------------------|---|---|---|--|---|-----------------|
| | | | | | A | B | C | D | | | |
| March | 1 | 8 | 16 60.8 | 1 | — | — | — | — | — | — | |
| | 2 | 8 | 15 59.0 | — | — | — | — | — | — | — | |
| | 3 | 8 | 15 59.0 | — | 2 | — | — | — | — | — | |
| | 4 | 7 | 16 60.8 | 1 | — | — | — | — | 10 | 30 | |
| April | 1 | 8 | 14 57.2 | — | — | — | — | — | — | — | |
| | 2 | 7 | 15 59.0 | — | 2 | — | — | — | — | — | |
| | 3 | 8 | 15 59.0 | 1 | — | — | — | — | 10 | 70 | |
| | 4 | 7 | 16 60.8 | — | — | — | — | — | — | — | |
| May | 1 | 8 | 16 60.8 | — | 2 | 2 | — | — | — | — | |
| | 2 | 8 | 17 62.6 | 1 | — | — | — | — | 20 | 80 | |
| | 3 | 8 | 19 66.2 | — | 2 | 2 | 2 | — | — | — | |
| | 4 | 7 | 16 60.8 | 1 | — | — | — | — | 30 | 80 | |
| June | 1 | 8 | 17 62.6 | — | 3 | 3 | 3 | 3 | — | — | |
| | 2 | 7 | 19 66.2 | 1 | — | — | — | — | 60 | 90 | |
| | 3 | 8 | 20 68.0 | — | 3 | 3 | 3 | 3 | — | — | |
| | 4 | 7 | 23 73.4 | 1 | 5 | 5 | 5 | 5 | 80 | 95 | |
| July | 1 | 8 | 22 71.6 | — | — | — | — | — | 80 | 95 | |
| | 2 | 8 | 25 77.0 | 1 | 6 | 6 | 6 | 6 | — | — | |
| | 3 | 8 | 22 71.6 | 1 | 4 | 4 | 4 | 4 | 136 | 90 | |
| | 4 | 7 | 24 75.2 | 1 | 5 | 5 | 5 | 5 | 84 | 95 | |
| Aug. | 1 | 8 | 21 69.8 | — | — | — | — | — | 80 | 15 | |
| | 2 | 8 | 24 75.2 | 1 | 5 | 5 | 5 | 5 | — | 90 | |
| | 3 | 8 | 22 71.6 | 1 | 4 | 4 | 4 | 4 | 100 | 90 | |
| | 4 | 7 | 21 69.8 | — | — | — | — | — | 80 | 12 | |
| Sept. | 1 | 8 | 19 66.2 | 1 | — | — | — | — | — | 85 | |
| | 2 | 7 | 18 64.4 | — | 3 | 3 | 3 | 3 | — | 80 | |
| | 3 | 8 | 19 66.2 | 1 | — | — | — | — | 60 | 9 | |
| | 4 | 7 | 17 62.6 | — | 3 | 3 | 3 | 3 | — | 80 | |
| Oct. | 1 | 8 | 17 62.6 | 1 | — | — | — | — | 60 | 9 | |
| | 2 | 8 | 19 66.2 | — | 3 | 3 | 3 | 3 | — | 80 | |
| | 3 | 8 | 16 60.8 | 1 | — | — | — | — | 60 | 9 | |
| | 4 | 7 | 17 62.6 | — | — | — | — | — | — | 75 | |
| Nov. | 1 | 8 | 16 60.8 | — | 2 | 2 | 2 | 2 | — | 60 | |
| | 2 | 7 | 16 60.8 | 1 | — | — | — | — | 40 | 6 | |
| | 3 | 8 | 15 59.0 | — | — | — | — | — | — | 5 | |
| | 4 | 7 | 15 59.0 | — | 2 | 2 | 2 | 2 | — | 5 | |
| Dec. | 1 | 8 | 16 60.8 | 1 | — | — | — | — | 40 | 6 | |
| | 2 | 8 | 15 59.0 | — | — | — | — | — | — | 5 | |
| | 3 | 8 | 15 59.0 | — | 2 | 2 | 2 | 2 | — | 5 | |
| | 4 | 7 | 15 59.0 | — | — | — | — | — | 40 | 6 | |
| Jan. | 1 | 8 | 16 60.8 | 1 | — | — | — | — | — | 30 | |
| | 2 | 8 | 15 59.0 | — | — | — | — | — | — | 0 | |
| | 3 | 8 | 14 57.2 | — | 2 | 2 | 2 | 2 | — | 0 | |
| | 4 | 7 | 16 60.8 | — | — | — | — | — | 40 | 6 | |
| Feb. | 1 | 7 | 14 57.2 | — | — | — | — | — | — | — | |
| | 2 | 7 | 13 55.4 | — | — | — | — | — | — | — | |
| | 3 | 7 | 14 57.2 | — | — | — | — | — | — | — | |
| | 4 | 7 | 14 57.2 | — | — | — | — | — | — | — | |

Table 58. *Progeny present from week to week, e.g. Sutton Dwellings. F₁ and F₂ generations from overwintered adults and nymphs. Italicized figures are percentages to nearest whole number based on total progeny for that week. Absence of larval mortality is assumed*

| Months and 'weeks' | Eggs (unhatched) | Nymphs | | | | | Adults | Total progeny | Total blood-sucking bugs | |
|--------------------|------------------|---------|---------|--------|--------|--------|--------|---------------|--------------------------|------|
| | | I | II | III | IV | V | | | | |
| March | 1 | — | — | — | — | — | — | — | — | |
| | 2 | — | — | — | — | — | — | — | — | |
| | 3 | — | — | — | — | — | — | — | — | |
| | 4 | 10 100 | — | — | — | — | — | 10 | — | |
| April | 1 | 10 100 | — | — | — | — | — | 10 | — | |
| | 2 | 10 100 | — | — | — | — | — | 10 | — | |
| | 3 | 20 100 | — | — | — | — | — | 20 | — | |
| | 4 | 17 85 | 3 15 | — | — | — | — | 20 | 3 | |
| May | 1 | 17 85 | 3 15 | — | — | — | — | 20 | 3 | |
| | 2 | 30 75 | 10 25 | — | — | — | — | 40 | 10 | |
| | 3 | 30 75 | 9 22 | 1 3 | — | — | — | 40 | 10 | |
| | 4 | 44 63 | 25 36 | 1 1 | — | — | — | 70 | 26 | |
| June | 1 | 44 63 | 23 33 | 3 4 | — | — | — | 70 | 26 | |
| | 2 | 110 81 | 23 17 | 3 2 | — | — | — | 136 | 26 | |
| | 3 | 86 63 | 24 18 | 23 17 | 3 2 | — | — | 136 | 50 | |
| | 4 | 107 50 | 59 27 | 24 11 | 23 11 | 3 1 | — | 216 | 109 | |
| July | 1 | 116 39 | 76 25 | 59 20 | 24 8 | 23 8 | 3 1 | 301 | 185 | |
| | 2 | 35 12 | 81 27 | 76 25 | 59 20 | 24 8 | 23 8 | 3 1 | 301 | 266 |
| | 3 | 189 42 | 0 0 | 81 18 | 76 17 | 59 13 | 24 5 | 26 6 | 455 | 266 |
| | 4 | 151 27 | 138 25 | 0 0 | 81 15 | 76 14 | 59 11 | 50 9 | 555 | 404 |
| Aug. | 1 | 211 30 | 95 13 | 138 19 | 0 0 | 81 11 | 76 11 | 109 15 | 710 | 499 |
| | 2 | 336 34 | 140 14 | 95 10 | 138 14 | 0 0 | 81 8 | 185 19 | 975 | 639 |
| | 3 | 424 33 | 239 18 | 140 11 | 95 7 | 138 11 | 0 0 | 266 20 | 1302 | 878 |
| | 4 | 564 37 | 343 22 | 54 4 | 90 6 | 91 6 | 138 9 | 266 17 | 1546 | 982 |
| Sept. | 1 | 689 37 | 295 16 | 239 13 | 140 8 | 95 5 | 138 7 | 266 14 | 1862 | 1173 |
| | 2 | 688 33 | 402 19 | 343 17 | 54 3 | 90 4 | 229 11 | 266 13 | 2072 | 1384 |
| | 3 | 612 27 | 479 21 | 295 13 | 239 11 | 140 6 | 95 4 | 404 18 | 2264 | 1652 |
| | 4 | 885 35 | 268 11 | 402 16 | 343 14 | 54 2 | 181 7 | 404 16 | 2537 | 1652 |
| Oct. | 1 | 850 31 | 495 18 | 211 8 | 295 11 | 239 9 | 144 5 | 495 18 | 2729 | 1879 |
| | 2 | 1225 38 | 332 10 | 268 8 | 402 13 | 343 11 | 140 4 | 499 16 | 3209 | 1984 |
| | 3 | 1143 34 | 379 11 | 495 15 | 211 6 | 534 16 | 54 2 | 585 17 | 3401 | 2258 |
| | 4 | 1135 33 | 372 11 | 332 10 | 479 14 | 295 8 | 239 7 | 639 18 | 3491 | 2356 |
| Nov. | 1 | 1071 28 | 723 19 | 341 9 | 503 13 | 269 7 | 265 7 | 639 17 | 3811 | 2740 |
| | 2 | 1158 29 | 753 19 | 340 9 | 304 8 | 480 12 | 265 7 | 639 16 | 3939 | 2781 |
| | 3 | 1261 31 | 728 18 | 341 8 | 401 10 | 451 11 | 55 1 | 878 21 | 4115 | 2854 |
| | 4 | 1513 34 | 796 18 | 341 8 | 401 9 | 451 10 | 55 1 | 878 20 | 4435 | 2922 |
| Dec. | 1 | 1449 32 | 930 20 | 394 9 | 138 3 | 719 16 | 50 1 | 883 19 | 4563 | 3114 |
| | 2 | 1584 33 | 953 20 | 410 9 | 136 3 | 691 15 | 82 2 | 883 19 | 4739 | 3155 |
| | 3 | 1896 38 | 961 19 | 395 8 | 149 3 | 693 14 | 78 2 | 887 18 | 5059 | 3163 |
| | 4 | 2006 39 | 969 19 | 405 8 | 149 3 | 692 13 | 119 2 | 887 17 | 5227 | 3221 |
| Jan. | 1 | 2040 39 | 976 19 | 428 8 | 142 3 | 667 13 | 119 2 | 887 17 | 5259 | 3219 |
| | 2 | 2136 40 | 985 18 | 427 8 | 145 3 | 667 12 | 115 2 | 892 17 | 5367 | 3231 |
| | 3 | 2456 43 | 1002 18 | 428 8 | 145 3 | 667 12 | 115 2 | 892 16 | 5705 | 3249 |
| | 4 | 2649 45 | 1007 17 | 429 7 | 144 2 | 667 11 | 117 2 | 892 15 | 5905 | 3256 |
| Feb. | 1 | 2467 45 | 1004 17 | 430 7 | 148 3 | 667 11 | 111 2 | 898 15 | 5725 | 3258 |
| | 2 | 2625 44 | 1026 17 | 429 7 | 148 3 | 668 11 | 111 2 | 898 15 | 5905 | 3280 |
| | 3 | 2624 44 | 1026 17 | 430 7 | 148 3 | 668 11 | 111 2 | 898 15 | 5905 | 3281 |
| | 4 | 2623 44 | 1027 17 | 430 7 | 147 2 | 669 11 | 111 2 | 898 15 | 5905 | 3282 |

Table 59. *Increase in total progeny and in blood-sucking phases only in terms of the original overwintered adults and nymphs (47 bugs)*

| Months and 'weeks' | Sutton Dwellings | | Oakworth Road | |
|-----------------------|------------------|-------------------------|------------------|-------------------------|
| | Total progeny | Blood-sucking phases | Total progeny | Blood-sucking phases |
| Mar. | 1 | 0 | — | — |
| | 2 | 0 | — | — |
| | 3 | 0 | — | — |
| | 4 | 0.21 | — | — |
| April | 1 | 0.21 | — | — |
| | 2 | 0.21 | — | — |
| | 3 | 0.43 | — | — |
| | 4 | 0.43 | 0.06 | — |
| May | 1 | 0.43 | — | — |
| | 2 | 0.85 | 0.21 | — |
| | 3 | 0.85 | 0.21 | 0.06 |
| | 4 | 1.5 | 0.55 | 0.32 |
| June | 1 | 1.5 | 0.53 | — |
| | 2 | 2.9 | 0.55 | 1.1 |
| | 3 | 2.9 | 1.1 | 2.4 |
| | 4 | 4.6 | 2.3 | 3.4 |
| July | 1 | 6.4 | 3.9 | 4.9 |
| | 2 | 6.4 | 5.7 | 4.9 |
| | 3 | 9.7 | 5.7 | 6.3 |
| | 4 | 11.8 | 8.6 | 6.3 |
| Aug. | 1 | 15.1 | 10.6 | 8.3 |
| | 2 | 20.7 | 13.6 | 10.3 |
| | 3 | 27.7 | 18.7 | 12.5 |
| | 4 | 32.9 | 20.9 | 16.3 |
| Sept. | 1 | 39.6 | 25.0 | 17.3 |
| | 2 | 44.1 | 29.4 | 19.1 |
| | 3 | 48.2 | 35.1 | 23.2 |
| | 4 | 54.0 | 35.1 | 23.4 |
| Oct. | 1 | 58.1 | 40.0 | 27.9 |
| | 2 | 68.3 | 42.2 | 29.1 |
| | 3 | 72.4 | 48.0 | 29.1 |
| | 4 | 74.3 | 50.1 | 29.1 |
| Nov. | 1 | 81.1 | 58.3 | 35.4 |
| | 2 | 83.8 | 59.2 | 35.4 |
| | 3 | 87.6 | 60.7 | — |
| | 4 | 94.4 | 62.2 | — |
| Dec. | 1 | 97.1 | 66.3 | — |
| | 2 | 100.8 | 67.1 | — |
| | 3 | 107.6 | 67.3 | — |
| | 4 | 110.4 | 67.7 | — |
| Jan. | 1 | 111.9 | 68.5 | — |
| | 2 | 114.2 | 68.7 | — |
| | 3 | 121.4 | 69.1 | — |
| | 4 | 125.6 | 69.3 | — |
| Feb. | 1 | 125.6 | 69.3 | — |
| | 2 | 125.6 | 69.8 | — |
| | 3 | 125.6 | 69.8 | — |
| | 4 | 125.6 | 69.8 | — |

(Fig. 33). The temperature chart (Fig. 2) shows that only for 1 week did the temperature drop as low as 13° C. The summer temperatures are very slightly higher than those at Oakworth Road. The probable effects of these differences are as follows:

- (1) Feeding occurs practically all the year round.

(2) The feeding frequency is slightly higher in the summer, and this, associated with very slightly higher temperatures, increases egg production as compared with the scheme for Oakworth Road.

(3) There is no long winter period with a very considerable mortality and with no reproductive activity.

(4) The winter temperatures are about optimal for survival of fasting bugs.

(5) Although many eggs are laid and incubated at 15° C. (particularly in the F_2 generation) and the mortality is very high, the variation of temperatures between 15 and 17° C. is likely to allow for a somewhat erratic mortality among eggs laid at these temperatures (Fig. 36).

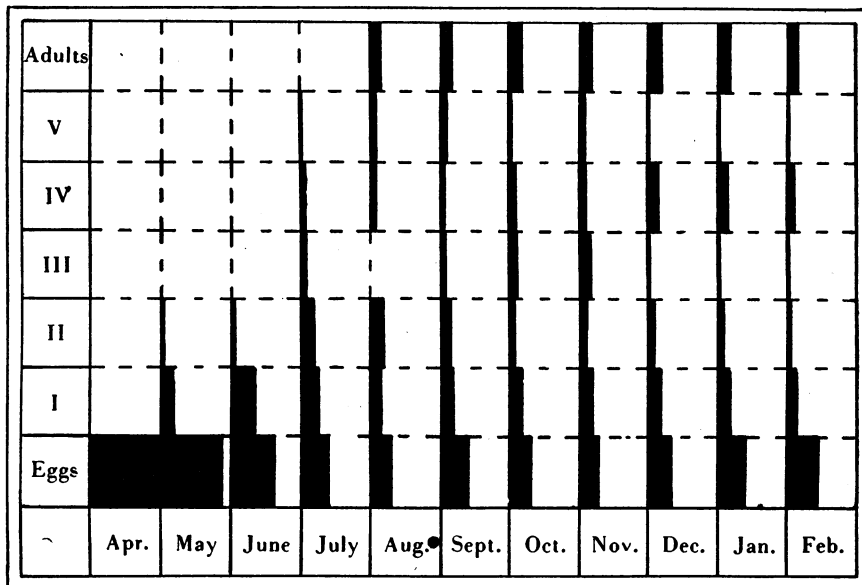

Fig. 33. Hypothetical scheme of population growth in a room similar to that at Sutton Dwellings. Black areas represent proportions of various stages, as percentages of total progeny. Abscissa for each week represents 100%. See Tables 57 and 58.

As with the scheme for Oakworth Road, little account can be taken with the present state of knowledge of mortality of nymphs and adults during the warmer months. But though with the Oakworth Road scheme some estimation of mortality during the winter months could be made, this is almost impossible with the scheme for Sutton Dwellings. Therefore, we are forced to consider something of the powers of increase alone, leaving aside the effects of mortality. In both schemes we have neglected mortality during the warmer months: it is therefore possible to compare the schemes, bearing this in mind. The differences shown will be primarily due to the differences in room temperatures.

Figs. 34 and 35 and Table 59 show the increase in total progeny, and in the biting phases of the insects only, to be expected in the two environments, in terms of the original number of overwintering bugs (47).

Although the summer temperatures are only slightly higher in Sutton Dwellings than in Oakworth Road, and the winter temperatures also are very close to the threshold for development with hatching and for moulting, the difference to be expected in the rate of increase both of eggs and bugs and of bugs alone is enormous. This difference is likely to lead to ever-increasing differences over the course of two or three years if no measures are taken

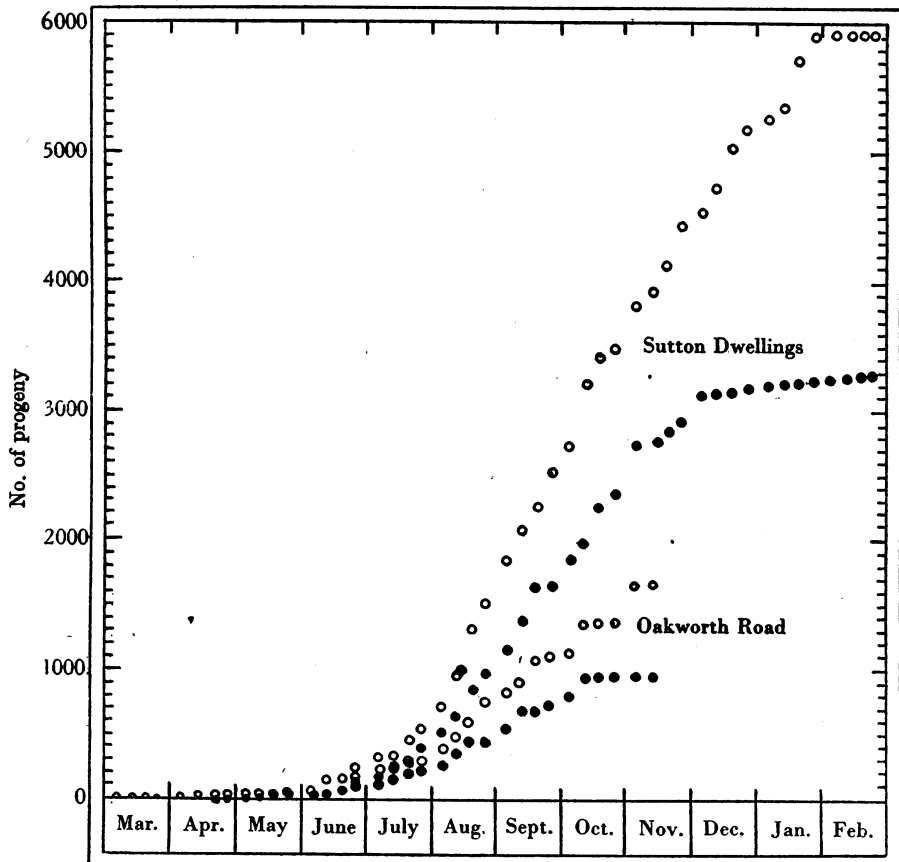

Fig. 34. Hypothetical population growth for Oakworth Road and Sutton Dwellings in terms of number of organisms. ○ = total progeny; ● = total sucking insects (i.e. excluding eggs). See Table 59.

against the pest, since mortality in the winter will be much lower in rooms like that of Sutton Dwellings as well as reproductive capacity in the summer months being considerably more. Moreover, although adults of the F_2 generation are presumably not produced in the Oakworth Road scheme, they are, and in considerable numbers, in that for Sutton Dwellings.

How do the proportions of the various stages and the percentage of unfertilized females found in the bed-sitting rooms (Tables 38 and 48) compare with the hypothetical scheme outlined above (Table 58)?

First instars are present in collections made in March from the Glasgow samples. And a higher proportion of fertilized females are present in the bed-sitting rooms than in the unheated bedrooms from flats.

The explanations for the presence of a large proportion of unfertilized females given for the Oakworth Road scheme hold good for Sutton Dwellings.

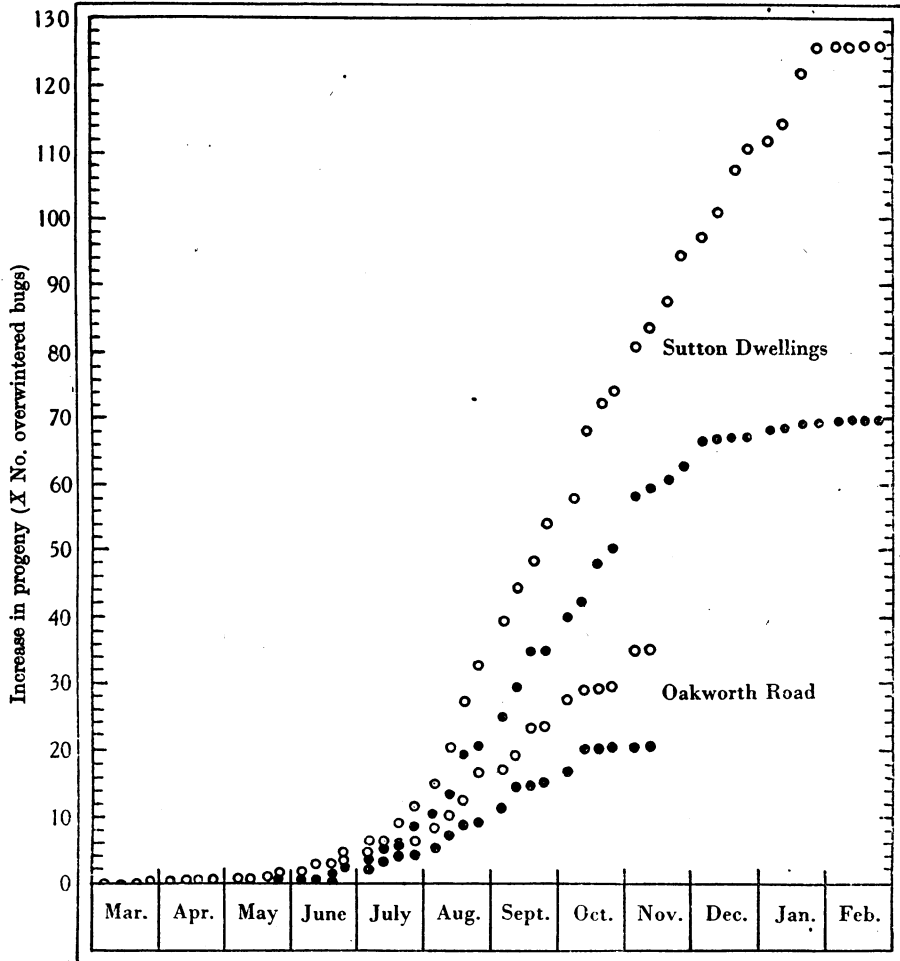

Fig. 35. Hypothetical population growth for Oakworth Road and Sutton Dwellings as increase in progeny in terms of overwintered population. ○ = total progeny; ● = total sucking insects. See Table 59.

But with the warmer types of bedrooms, a larger proportion of the virgin females are very probably those of the second generation which moulted late in the autumn just before the temperature dropped to 13–15° C.: many of these probably remained virgin until the following spring. As far as the proportions of the various nymphal and the adult stages during the period of active breeding and moulting are concerned, the proportions in Mellanby's wild

population (p. 419) are very similar to those expected in our hypothetical population during the weeks of active reproduction and development.

For ease of working I have assumed in the above scheme that all females of the second generation which moulted up till the end of October became impregnated. This is probably incorrect, but from the point of view of population growth it would probably not make much difference whether these mated and oviposited or not, since most of their eggs would be doomed to die unhatched if they were laid and incubated at 15° C.

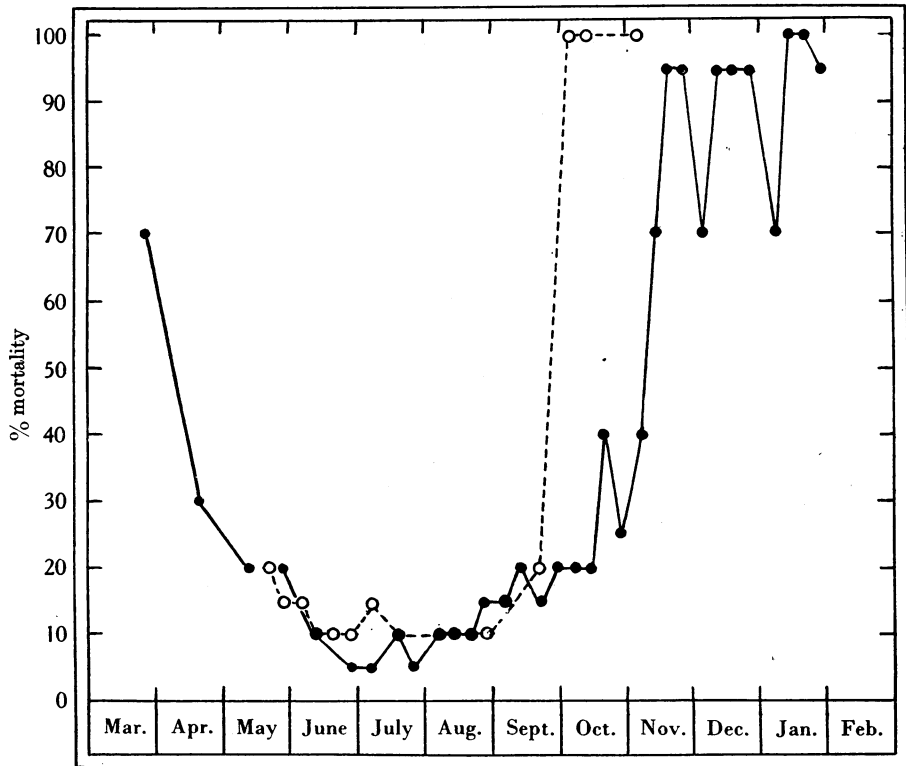

Fig. 36. Hypothetical trends of egg mortality at Oakworth Road (○) and Sutton Dwellings (●). See Tables 54-58.

There is another fact which cannot as yet be accounted for in a hypothetical scheme. This is the failure of the majority of nymphs to moult after a single meal if both prefeeding and incubation periods are at or below 15° C. I have assumed that if this occurs and the temperature then rises (as in the spring) the unmoulted bugs feed again and then moult if the second prefeeding period has been spent above 15-16° C. But when, in the autumn, the temperature drops, the fate of the unmoulted instars is not known. In the above scheme for Sutton Dwellings (the phenomenon does not, perhaps, occur to a marked extent in the Oakworth Road scheme) those which remain unmoulted

have been considered to remain in that instar until the spring. It is possible that on feeding a second time another 15–20 % moult. This, during the winter, would tend to cause the later instars to predominate. But the process would be very slow both on account of relatively long intervals between the meals and because such a small percentage would moult after each meal.

In Table 59, Figs. 34 and 35, I have shown the supposed increase in total progeny and in the sucking phases of the insects alone in the two types of dwelling. This, as stated before, omits consideration of larval mortality and, of course, winter mortality. Egg mortality is, however, shown, and some idea of the degree of importance we may expect it to assume. For as the autumn progresses, eggs may be laid at temperatures between 13 and 16° C., and the incubation periods will be spent in the same temperature range. This will produce a higher mortality which, together with relatively slight mortality in eggs during spring and summer, should account for a considerable difference between the numbers of sucking phases and the number of total progeny (i.e. sucking phases and eggs). The rate at which room temperature falls during the autumn is obviously of considerable importance, as Fig. 36 indicates.

This brief and very incomplete survey of the operation of some of the main factors in the biology of bed-bug populations takes no account of the possible effects of population density and competition for host and space, or of migration; of these problems nothing of worth has been published. While the population is comparatively small (i.e. some hundreds of bugs in a room) these factors are perhaps not of prime and direct importance in the subsequent happenings to a population. But as the available harbourages within the room are occupied and new ones are sought farther afield, the success in finding a host without much waste of time must enter into the story. Of these problems, however, nothing is known either in their relationship to the general ecology or as specific and isolated problems.

In this survey of the ecology of *C. lectularius* many facts relating to the mortality and egg production which appear in the literature have not been summarized. These are to be found particularly in the works of Kemper, Titschack, Janisch and Mellanby. But I have abstracted those data which are most relevant to the present problems of population growth. We possess now a good deal of data, gathered in the laboratory, on these points (particularly on egg production) which cannot easily be fitted into a comprehensive and fairly generalized picture of population growth. The whole subject must now be approached from a different angle and the deductive method from laboratory data must be supplemented, and perhaps temporarily replaced, by an inductive one which has as its basis quantitative work in the field and in experimental rooms.

It may be mentioned that the rate of increase in the population increases considerably when the second generation is produced. And Mellanby found (1939*b*) that although the bugs may have only a very short average adult life

(perhaps only 15 days) the original density is quickly regained. In his case, the temperature was continuously high and the bugs were killed by rats. But if man kills a large proportion of the adult population in the summer, the recovery of the original density might be very rapid if considerable numbers remained: in the winter this would perhaps not be so.

ACKNOWLEDGEMENTS

The present work was carried out under the general direction of the Bed-Bug Infestation Committee of the Medical Research Council, all expenses for 5 years being paid by a research grant from the Council. The investigations were made in the Department of Entomology, London School of Hygiene and Tropical Medicine, and it is a pleasure to thank Prof. P. A. Buxton, who has given invaluable help and generous hospitality. His staff also have given much encouragement, and my thanks are due particularly to Mr A. E. C. Harvey for his zeal, patience and reliability. Drs J. O. Irwin and W. J. Martin and Mr E. A. Cheeseman have helped greatly with statistical methods, Dr W. C. Gunn collected and sent many samples of insects, Miss F. R. Mold has made many drawings and Mr A. E. Fountain has helped with bibliographical matters; to all these my best thanks are due. Acknowledgements are extended to the Cambridge University Press and the editors for permission to republish Figs. 6, 10, 11, 12, 23 and 25 from *Parasitology*, vol. 32, and Figs. 2 and 3 from the *Journal of Hygiene*, vol. 38.

REFERENCES

- BACOT, A. W. (1914). The influence of temperature, submersion and burial on the survival of eggs and larvae of *Cimex lectularius*. *Bull. ent. Res.* **5**, 111-17.
- BLACKLOCK, B. (1912). On the resistance of *Cimex lectularius* to various reagents, powders, liquids and gases. *Ann. Trop. Med. Parasit.* **6** (4), 415-28.
- CRAGG, F. W. (1915). A preliminary note on fertilization in *Cimex*. *Ind. J. med. Res.* **2** (3), 693-705.
- (1920). Further observations on the reproductive system of *Cimex* with special reference to the behaviour of the spermatozoa. *Ind. J. med. Res.* **8**, 32-79.
- (1923). Observations on the bionomics of the bed-bug, *Cimex lectularius* L., with special reference to the relations of the sexes. *Ind. J. med. Res.* **11**, 449-73.
- DARLINGTON, C. D. (1939). The genetical and mechanical properties of the sex chromosomes. V. *Cimex* and the Heteroptera. *J. Genet.* **39** (1), 101-37.
- DRENSKI, P. (1928). Die in Bulgarien lebenden Wanzenarten (Fam. Cimicidae, Hem.) und die Mittel zur Bekämpfung derselben. *Trav. Soc. bulg. Sci. nat.* no. 13, pp. 63-9.
- GEISTHARDT, G. (1937). Über die ökologische Valenz zweier Wanzenarten mit verschiedenem Verbreitungsgebiet. *Z. Parasitenk.* **9** (2), 151-202.
- GIRAULT, A. A. (1905). The bed bug, *Clinocoris* (= *Cimex* = *Acanthia* = *Klinophilos*) *lectularia* Linnaeus. *Psyche*, **12**, 16-74.
- GUNN, W. C. (1933). *The Bed bug* (*Cimex lectularius*). *Prevention of House Infestation. A Study for Public Health Purposes*, 20 pp. Edinburgh: H.M. Stat. Office.
- HASE, A. (1917). Die Bettwanze (*Cimex lectularius* L.), ihr Leben und ihre Bekämpfung. *Z. angew. Ent.* **4** (1), 144 pp.

- HASE, A. (1919). Neue Beobachtungen über das Leben der Bettwanze (*Cimex lectularius* L.). *Zbl. Bakt.* I, orig. **83**, 22-39.
- (1930). Weitere Versuche zur Kenntnis der Bettwanze *Cimex lectularius* L. und *Cimex rotundatus* Sign. (Hex.-Rhynch.). Beiträge zur experimentellen Parasitologie 4. *Z. Parasitenk.* **2** (3), 368-418.
- (1935). Wohnungshygiene und Sperlingsnester. *Gesundheits-Ingenieur*, no. 9, 3 pp.
- JANISCH, E. (1933). Beobachtungen bei der Aufzucht von Bettwanzen. I. Über das Verhalten von Populationen bei verschiedenen Zuchtbedingungen. *Z. Parasitenk.* **5** (3/4), 460-514.
- (1935). Beobachtungen bei der Aufzucht von Bettwanzen. II. Über die Vermehrung der Bettwanze *Cimex lectularius* in verschiedenen Temperaturen. *Z. Parasitenk.* **7** (4), 408-39.
- JOHNSON, C. G. (1937). The relative values of man, mouse, and domestic fowl as experimental hosts for the bed-bug, *Cimex lectularius* L. *Proc. Zool. Soc. Lond.* Ser. A, Pt. 1, 107-26.
- (1938). Thermograph records in rooms of some London dwelling-houses throughout the year 1935-36 and their comparison with temperatures recorded in out-door meteorological stations. *J. Hyg., Camb.*, **38** (2), 222-32.
- (1939). Taxonomic characters, variability and relative growth in *Cimex lectularius* L. and *C. columbarius* Jenyns. (Heteropt., Cimicidae). *Trans. R. ent. Soc. Lond.* **89** (11), 543-68.
- (1940 a). Development, hatching and mortality of the eggs of *Cimex lectularius* L. (Hemiptera) in relation to climate, with observations on the effects of pre-conditioning to temperature. *Parasitology*, **32** (2), 127-73.
- (1940 b). The longevity of the fasting bed-bug (*C. lectularius* L.) under experimental conditions and particularly in relation to the saturation deficiency law of water-loss. *Parasitology*, **32** (3), 239-70.
- (1940 c). The maintenance of high atmospheric humidities for entomological work with glycerol-water mixtures. *Ann. Appl. Biol.* **27** (2), 295-99.
- JONES, R. M. (1930). Some effects of temperature and humidity as factors in the biology of the bed-bug (*Cimex lectularius* L.). *Ann. Ent. Soc. Amer.* **25** (1), 105-19.
- KASSIANOFF, L. (1936). Étude morphologique et biologique de la famille des Cimicidés. *Inst. d'Hyg. expt. et de Parasit. de l'Université de Lausanne* (Thesis), and *Ann. Parasit. hum. comp.* **15** (1937).
- KEMPER, H. (1929). Untersuchungen über die Sinnesorgane und die Sinnesphysiologie der Bettwanze. *Z. Desinfekt.* **21** (12), 285-97.
- (1930). Beiträge zur Biologie der Bettwanze (*Cimex lectularius* L.). I. Über den Einfluss des Nahrungsmangels. *Z. morph. Ökol. Tiere*, **19** (1), 160-83.
- (1931). Beiträge zur Biologie der Bettwanze (*Cimex lectularius* L.). II. Über die Häutung. *Z. morph. Ökol. Tiere*, **22** (1), 53-109.
- (1932). Beiträge zur Biologie der Bettwanze (*Cimex lectularius* L.). IV. Über das Zerreißen des Darmtrakts und die Mortalität unter ungünstigen Lebensbedingungen. *Z. Parasitenk.* **5** (1), 112-37.
- (1936). Die Bettwanze und ihre Bekämpfung. *Z. Kleintierkunde und Pelztierkunde*, XII. Jahrgang, Heft 3, 107 pp.
- LANDSBERG, H. (1938). Eine Bett-Temperatur-Studie. *Bioklimatische Beiblätter der Meteorologischen Zeitschrift*, **2**, 66-8.
- MARTINI, E. (1923). *Lehrbuch der medizinischen Entomologie*. Jena: Gustav Fischer.
- MELLANBY, K. (1935). A comparison of the physiology of the two species of bed-bug which attack man. *Parasitology*, **27** (1), 111-22.
- (1938). Activity and insect survival. *Nature, Lond.*, **141**, 554.

- MELLANBY, K. (1939*a*). Fertilization and egg production in the bed-bug, *Cimex lectularius* L. *Parasitology*, **31** (2), 193–9.
- (1939*b*). The physiology and activity of the bed-bug (*Cimex lectularius* L.) in a natural infestation. *Parasitology*, **31** (2), 200–11.
- (1939*c*). Low temperature and insect activity. *Proc. Roy. Soc. B*, **127**, 473–87.
- MELLANBY, K. & BUXTON, P. A. (1935). A toxic emanation from rubber. *Nature, Lond.*, **136**, 873.
- MOENS, WIBAUT-ISEBREE, N. L. (1925). Soorten van wantsen in woningen. *Ned. Tijdschr. Geneesk.*, **69** (1), 627–30.
- OMORI, N. (1938). Experimental studies on the influence of low temperatures upon the common bed-bug (*Cimex lectularius* L.). First Report: on the influence of a temperature of 0° C. *J. med. Ass. Formosa*, **37** (7), 1081–1103.
- REPORT ON THE BED-BUG (1934). *Reports on Public Health and Medicinal Subjects*, no. 72. Min. of Health, London.
- RIVNAY, E. (1932*a*). The influence of relative humidity upon the rate of development of the bed-bug, *C. lectularius* L. *Bull. Soc. ent. Egypte*, **1–2**, 13–16.
- (1932*b*). Studies in tropisms of the bed-bug, *Cimex lectularius* L. *Parasitology*, **24** (1), 121–36.
- SHELFORD, V. E. (1929). *Laboratory and Field Ecology*. London.
- SIOLI, H. (1937). Thermotaxis und Perzeption von Wärmestrahlen bei der Bettwanze (*Cimex lectularius* L.). *Zool. Jahrb.* **58** (3), 284–96.
- SLACK, H. D. (1939). Structural hybridity in *Cimex* L., *Chromosoma*, **1** (1), 104–18.
- TITSCHACK, E. (1930). Untersuchungen über das Wachstum, den Nahrungsverbrauch und die Eierzeugung. III. *Cimex lectularius* L. *Z. morph. Ökol. Tiere*, **17** (3), 471–551.
- UVAROV, B. P. (1931). Insects and climate. *Trans. ent. Soc. London*, **79** (1), 247 pp.
- WIGGLESWORTH, V. B. (1931). Effect of desiccation on the bed-bug (*Cimex lectularius*). *Nature, Lond.*, **127** (3200), 307–8.
- (1941). The sensory physiology of the human louse, *Pediculus humanus corporis* De Geer (Anoplura). *Parasitology*, **33** (1), 67–109.
- WIGGLESWORTH, V. B. & GILLETT, J. D. (1934). The function of the antennae in *Rhodnius prolixus* (Hemiptera) and the mechanism of orientation to the host. *J. exp. Biol.* **11** (2), 120–39.

APPENDIX A. ON TECHNIQUE

Culture methods

Feeding bugs. Bugs were always confined in tubes when being fed; the voile cap of the tube was pressed against the host and the insects pierced through the interstices of the voile. All the stock cultures and experiments (unless otherwise stated) were fed on rabbit. A long-eared rabbit was placed inside a box which allowed little room for movement, and the tubes of bugs were fixed to its ears with elastic bands. The usual method of allowing the rabbit's head to protrude through a hole at one end of the box was not used, since tubes if shaken off often break and the bugs may be lost. Instead, the whole rabbit was confined and the ears with tubes then lay flat along the sides of the rabbit. The rabbit shows little inclination to move in this position.

With fowl as host, tubes were clamped on the exposed skin of the shoulder while the fowl was strapped to an iron grid. For feeding on mice, the fur was removed from the belly with a hair-dissolving ointment (e.g. 'Veet'), the mouse fixed on its back by strips of adhesive tape across the paws, and the end of the tube applied to the bare skin. With man, tubes were strapped on the forearm.

All feeding was carried out in darkness in the 23° C. constant-temperature room: the period given was 15–20 min. unless otherwise stated.

Tubes for bugs. All experimental bugs were kept in 2×1 in. glass tubes covered at both ends with voile in order to avoid the building up of a high humidity around the bugs. No paper was kept inside the tubes but bugs sat on the voile (Fig. 37 A). Adults were kept singly or in pairs and nymphs in larger numbers (approximate maximum of 100 for first instars, 20 for fifth instars). Eggs were often confined in small tubes ($\frac{3}{4} \times \frac{1}{2}$ in.) with voile on one end. These methods are described elsewhere (Johnson, 1940 *a, b*).

Rearing stock. All stock insects were reared in mass culture, with rabbit as host, at 23° C. About 100 males and 100 females were kept in each $2 \times 1\frac{1}{2}$ in. tube (Fig. 37 B), with blotting paper for foothold and oviposition, and were fed once or sometimes twice a week. Eggs and nymphs were segregated weekly. All experimental work was done with the Beckenham stock, which has been kept in this laboratory since 1927, unless otherwise stated (see §§ 6 and 4 D, E). Bugs were handled with a brush or a pair of fine forceps.

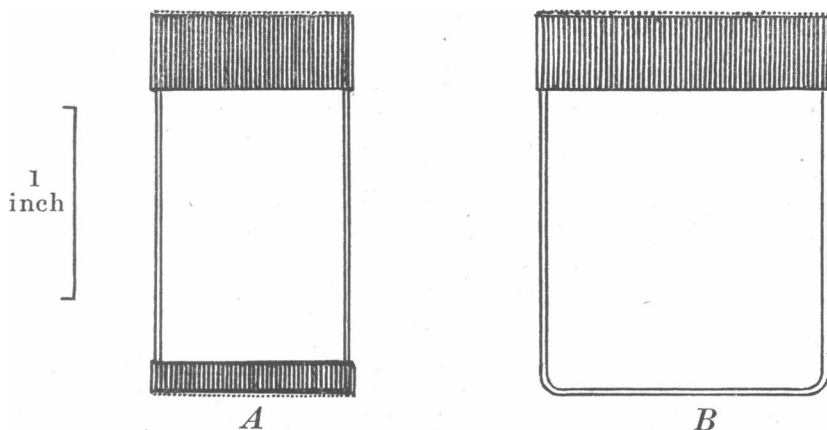

Fig. 37. Tubes for bugs. A. 2×1 in., with voile at both ends. Used in experiments.
B. $2 \times 1\frac{1}{2}$ in., with voile at one end only. Used for stock cultures.

Temperature and humidity control

Temperature. Constant temperatures were maintained in incubators and constant-temperature rooms: the amounts of fluctuation appear in the tables. For experiments on 'acclimatization' of eggs at the hatching thresholds, constant temperatures of $8-10^{\circ}$ C. were maintained in thermos flasks (Johnson, 1940).

Humidity. Humidity at 90% r.h. was kept constant to within about 2% for periods of many months, with a mixture of glycerol and water. The apparatus is described elsewhere (Johnson, 1940c) and consists of a 100 c.c. measuring cylinder containing the glycerol-water mixture through which air bubbles from a fine jet at about 15 l./hr. This air then passes through a container holding tubes of the experimental insects; the container is a battery or museum jar $7 \times 4 \times 2\frac{1}{2}$ in. with supports for the tubes, which lie horizontally with the voile ends towards the wide sides of the jar so that air flows past the bugs as they sit on the voile.

For 10 and 75% r.h. dilute sulphuric acid was used in the same apparatus.

The humidity was controlled by maintaining a suitable density of the mixture in the cylinder.

For all other humidities, closed desiccators or small 150 c.c. bottles were used with acid-water mixtures at the bottom: with bottles the tubes of bugs or eggs were suspended from the corks. Wherever possible corks were used rather than rubber bungs in order to eliminate possible toxic effects (Mellanby & Buxton, 1935).

Weighing. Bugs were weighed by placing them in a cone of metal foil, suspended from the hook of a torsion balance. This caused no injury to the bugs as often happens if they are suspended by wire loops fixed round the thorax. This latter method, moreover, may lead to undue activity and so introduce an additional and uncontrolled variable.

Collection from houses

When bugs were collected personally from London houses an attempt was made to collect random samples so as to avoid selection of adults only. No attempt was made to collect eggs. Where bugs were fairly thickly clustered in cracks or behind wooden structures, they were scraped out of the harbourages into a porcelain dish, the sexes segregated and placed in specimen tubes. Door frames and battens were removed from walls wherever possible and bugs were collected from these and from the walls where they had been fixed.

With bugs sent from Glasgow similar methods to avoid selection were used.

Breeding in mouse cages (free-living populations)

The type of cage used is shown in Fig. 38. It consisted of a stout straight-sided glass dish, $5\frac{1}{2}$ in. in diameter and $4\frac{1}{4}$ in. deep, with a lid of perforated zinc. Inside this cage was a ring of perforated zinc $2\frac{1}{2}$ in. deep which supported on its outer face a slightly narrower belt of corrugated card fastened with a paper-clip. The zinc and card fitted closely around the inside of the glass jar which had a little sawdust scattered on the floor.

Bugs were introduced into the spaces between the zinc and corrugated card and a mouse was placed in the cage each night. The whole cage was stood in a dish of water.

The experimental hut

A hut was made in which it was possible to liberate a number of bugs to prevent their escape and to keep count of them. This hut measured 8 ft. long \times 5 ft. wide \times $6\frac{1}{2}$ ft. high. It had a wooden frame of 3×2 in. timber and the walls were made of large sheets of 'Sundela', a hard compressed fibrous material $\frac{3}{8}$ in. thick. The floor was made of a hard quality Sundela fastened to supporting timbers. All cracks round the floor, walls and ceiling were covered with wide adhesive tape. The walls and ceiling, which were quite flat and with no projections, were covered with offwhite distemper.

In the roof was a skylight $3 \times 2\frac{1}{2}$ ft. and in one wall a door $2\frac{1}{2} \times 4\frac{1}{2}$ ft. The bottom edge of the door was $11\frac{1}{2}$ in. from the floor.

In order to prevent bugs from escaping through the door and the skylight, strips of glass $2\frac{1}{2}$ in. wide were let into the Sundela walls so that both door and skylight were surrounded by a glass surface over which it was impossible for bugs to crawl.

The hut stood on legs 8 in. high, which rested on tiles placed in a shallow iron tray. The floor of the tray was covered with a layer of lubricating oil to guard against the slightest possibility of escaping bugs.

Harbourages consisted of pieces of corrugated card (5×6 in.) fixed to the two opposite walls, $1\frac{1}{2}$ ft. from the floor. The hosts used were rabbits, guinea-pigs and fowls.

The rabbits and guinea-pigs were kept in a cylindrical cage made of wire mesh with stiff wire supports soldered only at the ends so that along their length they did not touch the mesh and form harbourages for the bugs. The floor of the cage was of zinc. By making the cages cylindrical and standing the supports away from the mesh, all unnecessary angles which may have served as harbourages were eliminated, thus minimizing the number of bugs which could sit unnoticed on the cage itself. The cage was suspended from the ceiling and fastened by a hook to the nearest wall. Strips of perforated zinc reached from the cage floor to the hut floor and allowed bugs to reach the host.

For chickens, however, a perch standing on the floor was substituted for the cage. The chicken was tethered and hooded and put in overnight.

Traps. Traps for catching bugs in the hut were designed to ensure that trapped bugs could not escape.

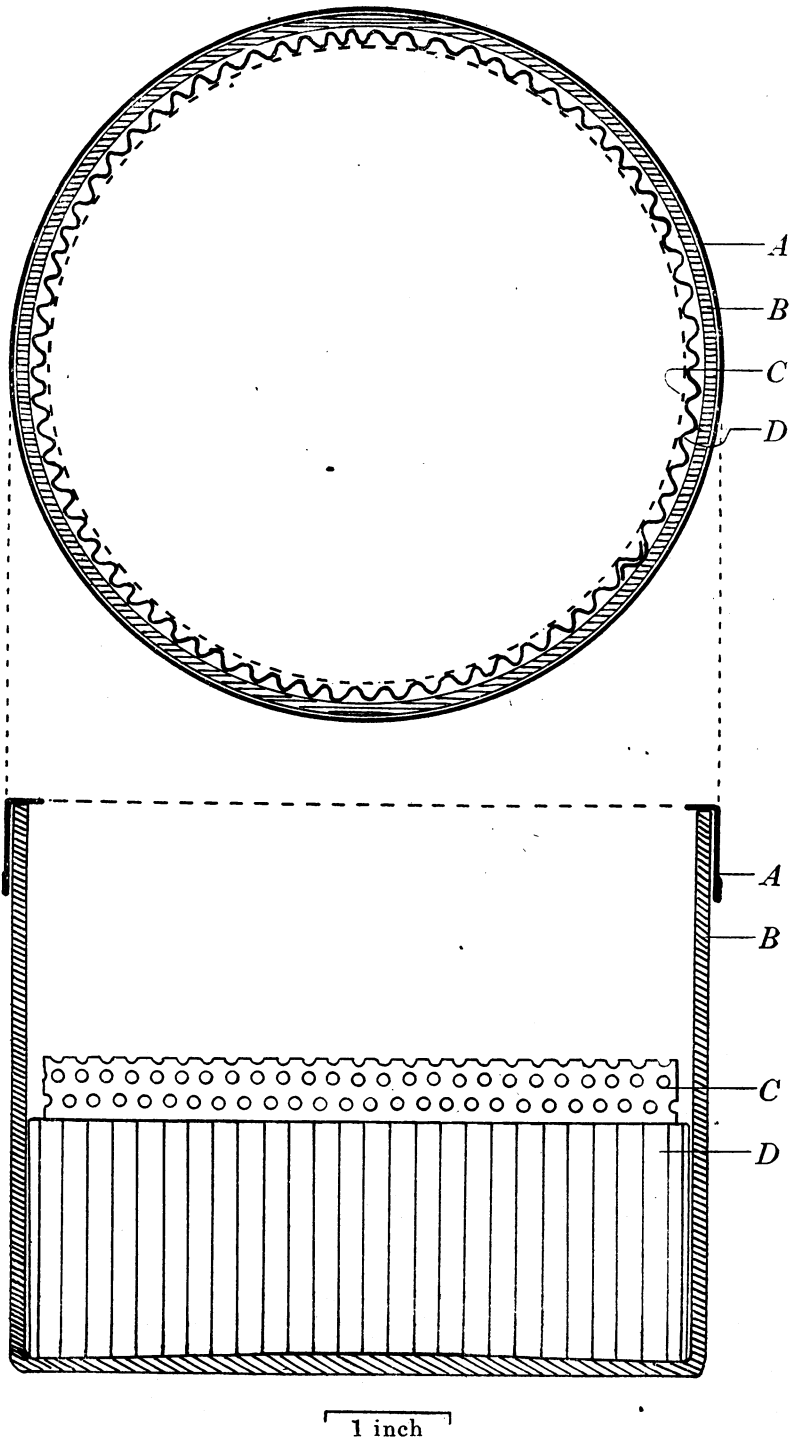

Fig. 38. Type of cage for free-living bed-bug populations kept with mouse. A. Lid of perforated zinc. B. Glass jar. C. Ring of perforated zinc. D. Corrugated card with smooth half removed. See Tables 9, 50 and 51.

The outer wall of a large Petri dish, 8 in. diameter and 2 in. high, was covered with paper so as to enable bugs to walk up it. In the centre of this dish was a cork or a glass stopper which supported a smaller inverted Petri dish ($5\frac{1}{2} \times \frac{6}{10}$ in.). It was necessary to select this dish so that the edge where the floor met the wall (E, Fig. 39) was rounded rather than angular. From the edges of the large dish four labels 1 in. wide were fixed so as to form

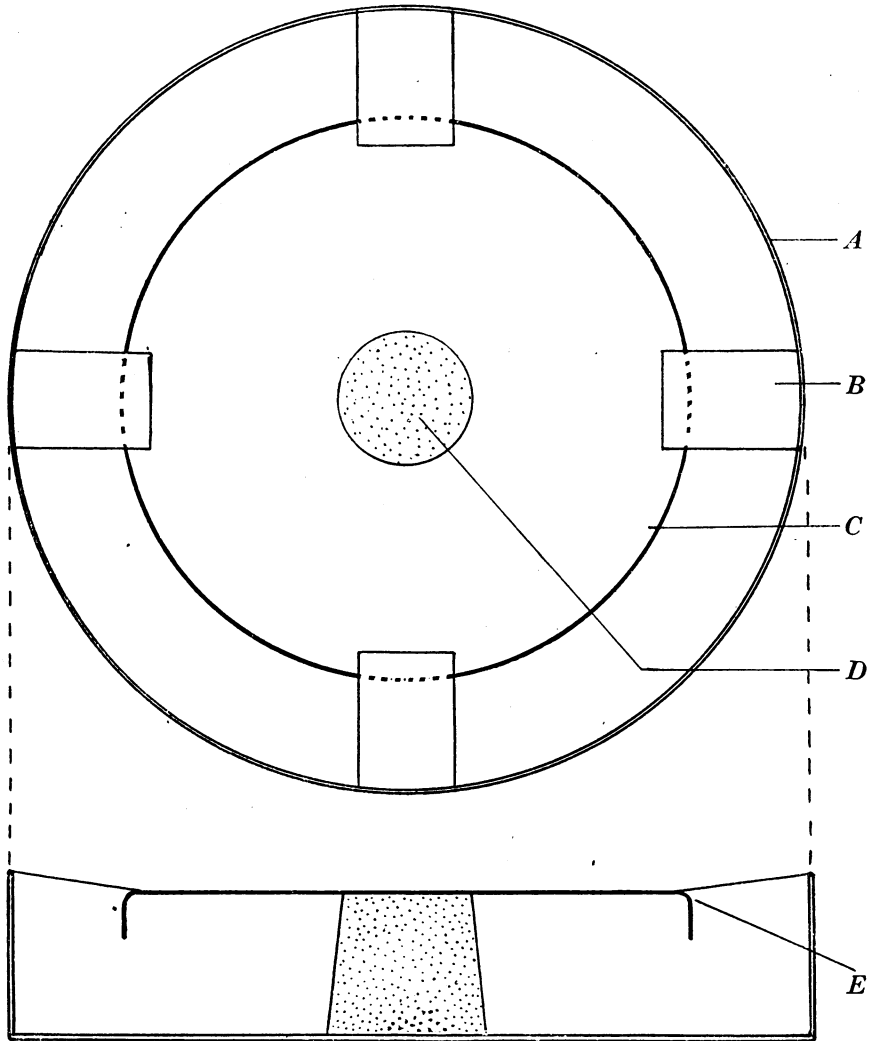

Fig. 39. Trap used in experimental hut. A. Large Petri dish. B. Paper bridge. C. Small Petri dish. D. Cork. E. Rounded edge of inner dish.

bridges by which bugs could walk on to the surface of the inner dish. Bugs which encountered the trap would walk up the paper-covered wall and around the edge of the large dish until they came to a bridge. This would be crossed and the insects would run over the surface of the inner dish until they came to the edge when foothold would be lost and they would fall into the trap. Paper placed in the trap served as harbourages to discourage excessive

activity. It was essential to keep the surface and edge of the inner dish clean so that foothold was easily lost.

These traps, placed on the floor between harbourages and the host, proved very efficient once the inner Petri dish was reached, and no bugs once trapped could escape.

Marking bugs. For purposes of identification bugs were marked with paint on the thorax. Two kinds were used:

- (1) 'Celamel': a paint containing amyl acetate.
- (2) 'Robbialac.'

Neither of these was toxic in the amounts used as proved by an experiment where twenty bugs were painted with Robbialac, twenty with Celamel and twenty left unpainted. They were allowed to starve and inspected at intervals. All died at the same rate.

The method of marking was as follows. Nine colours were used, each colour being distinct and representing a numeral 1-9. Then by putting two spots side by side a number such as 24 or 12 could be written. Thus three spots side by side gave a number of, for example, 223 or 486. It was not easy to get 10 distinct colours in Robbialac and therefore numbers containing 0 had to be omitted.

APPENDIX B. ON FUTURE RESEARCH

This report attempts to show how much is known about the ecology of the bed-bug and also where our ignorance lies. Points on which we have little knowledge and their significance to the whole study are frequently mentioned in the text. But it is worth while to restate some of the problems which appear to be more immediately relevant to the greater systemization of the knowledge presented in the previous pages. Such problems may be grouped under four headings.

(1) *Problems of immediate importance for population studies*

A perusal of Part II of this section of the report brings forward two main and two subsidiary problems.

The frequency with which bugs emerge and feed in nature at different seasons profoundly affects the size of the population and is probably the most important problem for future ecological work. It must be solved before accurate estimations of population changes can be made. The frequency of feeding and the length of resting periods must be correlated with temperature, light and perhaps humidity. It must be done for adults because this affects egg production (I, 4, B, *a*) and for nymphs because it affects the rate of development (I, 3, B, *c*, *d* and *e*) and therefore the numbers of adults. The degree of nuisance is also increased as feeding frequency increases (see (3) below). We know very little about the factors which induce bugs to leave harbourages or if the mere presence of a host has an effect (I, 8).

The next point in order of importance is perhaps the rate of development (and therefore the reproductive potential) as affected by the sojourn of nymphs at temperatures around 15° C. *before they have fed*. Why do first instars so kept refuse to feed even when put at a higher temperature, and why do the later stages, if fed, refuse to moult if the temperature *during the prefeeding period* has been low (I, 3, D, *a* and *b*)? We do not know if the condition is permanent or temporary or how many subsequent feeds are necessary before the nymphs moult into the next stage. Moreover, if eggs hatch at low temperatures the first instars may refuse to feed and may nearly all die. Do these things occur in nature?

As long as bugs have constant access to blood humidity may be of slight importance in the warm weather (i.e. apart from its possible effects on the feeding cycle). But in cold weather when bugs are resting its influence on mortality may be very great (I, 5, C); it will also affect the numbers hatching at about 13° C. (I, 3, C, *a*). Nothing, however, is known about the humidities around bugs in nature.

It cannot be too strongly stressed that many of the experiments described in this report have been made with cultures bred at 23° C. (English summer temperature). It will be laborious but necessary to find how bugs react to similar experiments after they have been cultured for long periods at 18–20° C.

(2) *The development of field studies on the basis of present theory*

Our knowledge of bug populations is largely deductive (Part II) and must be checked by work on populations in the field or under semi-natural environments where conditions at different seasons can be followed for long periods with some accuracy. Observations on times of year for hatching, oviposition, appearance of successive generations, cessation of feeding and breeding must be made on a wide scale with the theoretical picture as a guide. Marking and trapping experiments may help in estimating changes in the populations throughout the year, and the methods used by Jackson for tsetse flies could be checked by direct counting in the experimental hut.

Specific problems in field work or semi-natural experiments are:

The collection of more wild samples for sex ratio and the proportion of barren females particularly between May and September (I, 4, E).

The frequency of copulation in natural populations and in the laboratory at temperatures between 15 and 23° C. (I, 4, C, d).

The maximum longevity of bugs in nature when opportunities to feed are frequent (I, 5, C and D).

The maximum distance from the host at which harbourages are established and the success with which the host is found. Bound up with this are the effects of activity on mortality and fecundity (I, 5, D).

Migration and population density. What is the maximum density in a harbourage before recolonization starts? Does, for example, the colour of the background influence the choice of resting place or do the strongly thigmotropic reactions of the bug outweigh such physical factors.

The attractiveness of former resting places (I, 8, C).

(3) *Problems of importance to the sanitarian directly and for population studies*

The whole subject of host-bug relationship from the *host's point of view* is vague.

What is the mortality due to man apart from official efforts at control? How does this affect the theoretical picture of population growth?

Some folk suffer more than others from bug bites. Is this due to relative lack of immunity to reaction (some people readily acquire immunity and others apparently never do), because bugs avoid some people, or is it merely accidental or psychological?

What population density of bugs constitutes a real nuisance and how does it vary with different people? This problem is linked with the frequency of feeding and may be worth investigation; for estimates made by sanitarians depend a good deal on the answers given by people who live with bugs. What percentage of the total bug population emerge each night?

Methods of estimating the size of natural populations (see suggestions for marking experiments, above). It may be unsafe to estimate the success of control methods by a cursory inspection in the few weeks which follow fumigation, especially if this is done in the autumn or winter; for bugs may not emerge or may die natural deaths in cold weather.

Gough (1940) showed that starved bugs may be more resistant to a fumigant than fed ones. But to make allowance for this in practice will depend on our knowledge of the amount of starvation which occurs in nature.

(4) *Some problems of apparently less immediate importance*

The fecundity of individual females varies greatly and there are apparently still factors which have been inadequately controlled in our experiments. Body size is known to affect the numbers of eggs laid and more recently it appears that testis size and chromosome content are also correlated with it (Darlington, 1939). Body size is also correlated with latitude and perhaps also with climate. The problem of local races suggests itself (I, 4).

What is the fate of sperms from successive and different males? Have they a genetic importance?

What is the natural mortality during the warmer months of the year when feeding is frequent? This has been neglected in Part II.

What factors influence the behaviour of individual bugs and how is this affected by previous environment (p. 433)?

(*MS. received for publication 10. ix. 41.—Ed.*)