

Effects of Altering the ATP/ADP Ratio on Pump-mediated Na/K and Na/Na Exchanges in Resealed Human Red Blood Cell Ghosts

BRIAN G. KENNEDY, GORM LUNN, and JOSEPH F. HOFFMAN

From the Department of Physiology, Yale University School of Medicine, New Haven, Connecticut 06510

ABSTRACT Resealed human red blood cell ghosts were prepared to contain a range of ADP concentrations at fixed ATP concentrations and vice versa. ATP/ADP ratios ranging from ~0.2 to 50 were set and maintained (for up to 45 min) in this system. ATP and ADP concentrations were controlled by the addition of either a phosphoarginine- or phosphocreatine-based regenerating system. Ouabain-sensitive unidirectional Na efflux was determined in the presence and absence of 15 mM external K as a function of the nucleotide composition. Na/K exchange was found to increase to saturation with ATP ($K_{1/2} \cong 250 \mu\text{M}$), whereas Na/Na exchange (measured in K-free solutions) was a saturating function of ADP ($K_{1/2} \cong 350 \mu\text{M}$). The elevation of ATP from ~100 to 1,800 μM did not appreciably affect Na/Na exchange. In the presence of external Na and a saturating concentration of external K, increasing the ADP concentration at constant ATP was found to decrease ouabain-sensitive Na/K exchange. The decreased Na/K exchange that still remained when the ADP/ATP ratio was high was stimulated by removal of external Na. Assuming that under normal substrate conditions the reaction cycle of the Na/K pump is rate-limited by the conformational change associated with the release of occluded K [$E_2 \cdot (\text{K}) \cdot \text{ATP} \rightarrow E_1 \cdot \text{ATP} + \text{K}$], increasing ADP inhibits the rate of these transformations by competition with ATP for the $E_2(\text{K})$ form. A less likely alternative is that inhibition is due to competition with ATP at the high-affinity site (E_1). The acceleration of the Na/K pump that occurs upon removing external Na at high levels of ADP evidently results from a shift in the forward direction of the transformation of the intermediates involved with the release of occluded Na from $E_1\text{P} \cdot (\text{Na})$. Thus, the nucleotide composition and the Na gradient can modulate the rate at which the Na/K pump operates.

INTRODUCTION

The Na/K pump normally operates to exchange internal Na for external K across the cell membrane. Not only can this process be inhibited by cardiotonic

Address reprint requests to Dr. Joseph F. Hoffman, Dept. of Physiology, Yale University School of Medicine, 333 Cedar St., New Haven, CT 06510. Dr. Kennedy's present address is Dept. of Physiology, University of Pennsylvania, Philadelphia, PA 19104. Dr. Lunn's present address is Dept. of Germination, Danish Seed Testing Station, 2800 Lyngby, Denmark.

steroids such as ouabain, but the Na/K pump can also carry out several alternative ouabain-sensitive modes of exchange (for review, see Glynn and Karlish, 1975; Cavieres, 1977; Robinson and Flashner, 1979). The present work attempts to characterize further both Na/K exchange and one of the alternative modes, Na/Na exchange. These pump-catalyzed exchanges are examined in resealed human red blood cell ghosts with particular reference to the effects caused by systematic changes in the internal adenine nucleotide composition.

Na/K exchange has been studied extensively in human red blood cells, amphibian skeletal muscle, and squid giant axon. Pump-mediated Na/Na exchange has also been observed in all three preparations (Garrahan and Glynn, 1967*a-c*; Levin et al., 1968; Baker et al., 1969; De Weer, 1970; Keynes and Steinhardt, 1968). Both of these modes of exchange have been characterized as a function of internal and external alkali metal ion concentrations. However, very few studies have been made to evaluate the response of these transport systems to stable alterations in the adenine nucleotide composition present at the inner face of the pump. Limited analyses have been carried out in dialyzed squid giant axons (Brinley and Mullins, 1968; Mullins and Brinley, 1967; Beaugé and DiPolo, 1981), injected squid axons (De Weer, 1970), and resealed human red cell ghosts (Garrahan and Glynn, 1967*b*; Glynn and Hoffman, 1971; Cavieres and Glynn, 1979; Kaplan and Hollis, 1980; Hoffman, 1980; Eisner and Richards, 1981). The presence of adenylate kinase activity (Tatibana et al., 1958), which equilibrates ATP with ADP and AMP, has made it difficult to vary nucleotide ratios extensively enough to test whether specific changes in transport can be associated with a particular type of nucleotide. On the other hand, nucleotide effects on ouabain-sensitive Na,K-ATPase activity in porous ghosts or microsomal preparations have been studied in depth (Glynn and Karlish, 1975; Robinson and Flashner, 1979; Hoffman, 1980).

The present study employs resealed red blood cell ghosts (Hoffman, 1962, 1980; Bodemann and Passow, 1972), using a protocol that involves the incorporation of an adenylate kinase inhibitor and a nucleotide regenerating system that provides the flexibility to vary either ATP or ADP at a fixed concentration of the other nucleotide. Ouabain-sensitive Na efflux has been measured in the presence and absence of external K to assay Na/K and Na/Na exchange, respectively (Garrahan and Glynn, 1967*c*; Glynn and Hoffman, 1971). The characterization of these modes of exchange as a function of the nucleotide composition at the internal face of the pump indicates ways the pump rate can be modulated and provides insight into its reaction mechanism. Brief descriptions of some of these results have previously appeared (Kennedy et al., 1980, 1983; Hoffman et al., 1981).

MATERIALS AND METHODS

This study involves the use of resealed ghosts that were made by a procedure involving two hemolyses. The first hemolysis was carried out at a hemolytic ratio of 1 vol cells to 70 vol hemolyzing solution and was designed not only to reduce the cellular concentration of endogenous metabolites but also to dilute the cytoplasmic concentration of adenylate kinase. At the second hemolysis (1 vol cells to ~30 vol solution), an adenylate kinase

inhibitor was introduced, together with adenine nucleotides and a regenerating system. The details of the protocol follow.

Preparation of Resealed Ghosts

Blood from healthy donors was drawn into heparin (5 mg/100 ml) and the red cells were washed three times at 4°C by suspension and centrifugation (1 min at 12,000 *g*) with 5 vol of solution containing 150 mM NaCl and 10 mM HEPES (pH 6.8 at 20°C). The packed cells at the end of the third washing (1 min at 12,000 *g*) were cooled in an ice bath and then hemolyzed by squirting 50 ml of cells into 3,500 ml of vigorously stirred hemolyzing medium (3 mM MgCl₂, 0.1 mM EDTA, and 5 mM HEPES, pH 6.5 at 0.3 ± 0.2°C). After 5 min, equal volumes of 3 M NaCl and 3 M KCl were added to bring the concentration of Na plus K in the hemolysis mixture to 150 mM. The pH was adjusted to 6.8 and the ghosts were resealed by incubating the suspension for 30 min at 37°C.

Appreciable adenylate kinase activity remains in ghosts even after considerable dilution of the intracellular contents (Cavieres and Glynn, 1979; Hoffman, 1980). We therefore further decreased this activity by hemolyzing a second time and incorporating the adenylate kinase inhibitor P¹,P⁵-di(adenosine-5')pentaphosphate (A_{p5}A), described by Lienhard and Secemski (1973). Thus, the resealed ghosts obtained after the first hemolysis were washed twice at ~1°C with 5 vol of 150 mM NaCl plus 10 mM HEPES, pH 6.8, and concentrated at 48,000 *g* for 5 min. These packed ghosts were then rehemolyzed by squirting a 30–40-ml aliquot into 1,000 ml of 5 mM MgCl₂, 0.1 mM EDTA, and 5 mM HEPES, pH 6.5 at 0.3 ± 0.2°C. Two different enzyme systems (referred to as regenerating systems) were used to maintain stable internal ATP and ADP levels in these experiments. Each regenerating system entailed different additions to the second hemolysis and reversal media, so each system is described separately below.

The hemolyzed ghost suspension (from the second hemolysis) was normally divided into four equal parts, each of which was to be resealed separately and prepared to contain a different nucleotide mixture. In early experiments, the suspension was brought to pH 7.4 and then added directly to flasks containing the desired reversal media at 1°C. The flasks were next transferred to a water bath at 37°C for 15 min to allow the ghosts to reseat. Since large resealing volumes waste significant quantities of isotope, nucleotides, and other components of the reversal mixture, we decided in later experiments to concentrate the porous ghosts by centrifugation (27,000 *g* for 15 min at ~0.5°C) before reversal. The concentrated ghosts were then added to the reversal media (at a 10-fold-lower volume than used in the earlier experiments) and resealed as described above. The results obtained with ghost preparations from the two protocols were completely equivalent.

Creatine Kinase System

A regenerating system involving creatine phosphate, a high-energy phosphate donor, has previously been incorporated into red blood cell ghosts to replenish ATP hydrolyzed during the course of an experiment (Glynn and Hoffman, 1971; Glynn and Karlsh, 1976). In the present work, creatine kinase (rabbit muscle or beef heart, ~100 U/mg; Sigma Chemical Co., St. Louis, MO) was incorporated at the second hemolysis (0.1–0.2 mg/ml hemolysate). Creatine phosphate (sodium salt; Sigma Chemical Co.) was added at reversal from a 500-mM stock solution to give a final concentration of 10–15 mM. The ATP (sodium salt; Sigma Chemical Co.) concentration was varied by incorporating different amounts of a 100-mM stock solution at reversal. Fig. 1 shows the relationship of ATP incorporated at reversal to the average concentration of ATP present during a 30-

min efflux experiment at 37°C. The scatter of the data points in Fig. 1 (and Fig. 2 as well) indicates the reproducibility of procedures for establishing internal nucleotide concentrations. We do not know the basis for the variability. In all experiments using the creatine kinase regenerating system, the average decrement in ATP concentration over the 30-min efflux period was 5% and the mean concentration of ADP present during this period was 0.08 mM. Under the conditions of our experiments, the maintenance of a low ADP concentration in the presence of excess creatine kinase was expected since Watts (1973) has reported the equilibrium constant $K = (\text{MgADP})(\text{free creatine phosphate})/(\text{MgATP})(\text{free creatine})$ to be ~ 0.01 (pH 7.4, 30°C), which strongly favors the synthesis of ATP.

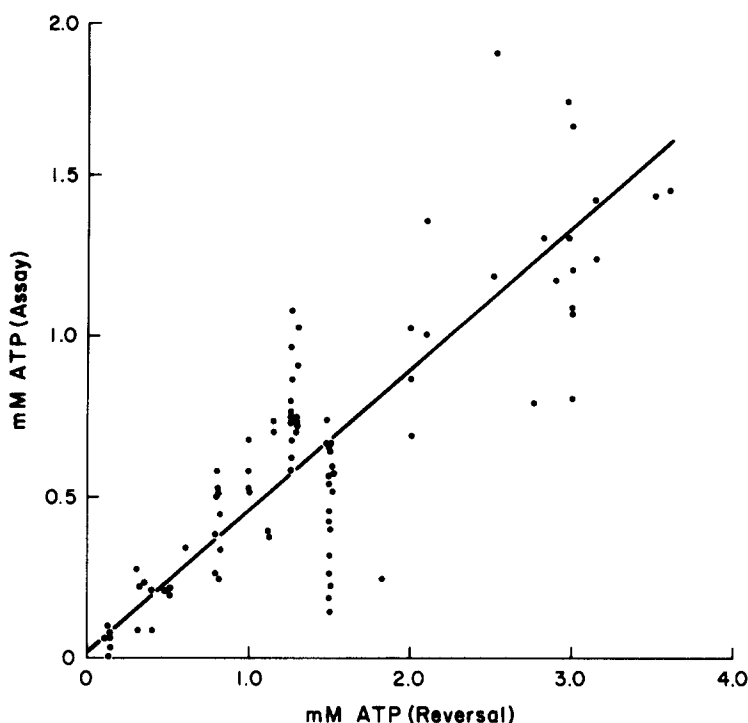

FIGURE 1. Relationship between the ATP concentration added at reversal, in the presence of the phosphocreatine regenerating system, to that assayed in the resealed ghosts. Ghosts were resealed to contain ATP concentrations as shown. The other constituents of the reversal media are described in the text. The ATP values plotted on the ordinate are average values over a 30-min incubation at 37°C. In general, ~ 2 h elapsed between reversal and the final 30 min of incubation at 37°C. The straight line is the best least-squares fit to the data points.

Arginine Kinase System

In order to manipulate ATP in the presence of appreciable levels of ADP and also to vary ADP itself, we needed a different regenerating system with an equilibrium poised closer to unity that would thus be able to buffer a steady state composed of both ATP and ADP. Morrison (1973) quotes the equilibrium of the arginine kinase system, $K = (\text{MgADP})(\text{free phosphoarginine})/(\text{MgATP})(\text{free arginine})$, to be near 0.5. Our strategy has been to

incorporate excess arginine and phosphoarginine so that their concentrations will not change appreciably over the course of an experiment. By varying the phosphoarginine/arginine ratio, a range of different ADP/ATP ratios can be set and maintained. We have been able to manipulate the ADP/ATP ratio from ~ 0.5 up to 5.0.

Arginine kinase (100 U/mg protein; Sigma Chemical Co.) was added to the second hemolyzing solution at a final concentration of 3 mg protein/liter with 5 mM 2-mercaptoethanol also present (to protect the kinase from oxidation). Phosphoarginine (5–10 mM), arginine (0–35 mM), ADP, and ATP were all added to the reversal media. The precise concentrations needed to set a particular ADP/ATP ratio were determined by trial and error. We observed an apparent K (as defined above) equal to 0.6. Fig. 2 shows

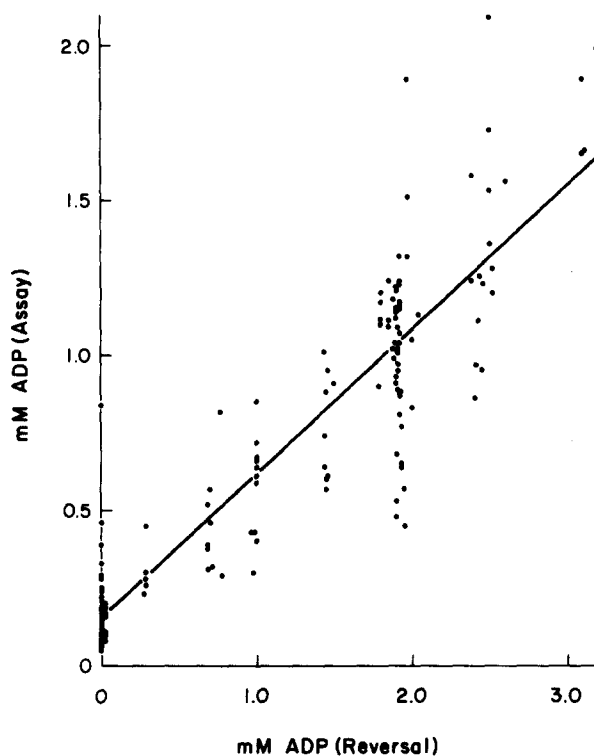

FIGURE 2. Relationship of the ADP concentration added at reversal to that measured in resealed ghosts. These ghosts contain the phosphoarginine regenerating system. Experimental details are as described in the text and in the legend to Fig. 1.

the relationship between ADP added at reversal and ADP observed at the midpoint of a 30-min efflux experiment. On the average, the ADP concentration fell by $\sim 8\%$ and ATP concentrations increased by 10% (these numbers were not significantly different from each other by a t test analysis) over the course of an efflux experiment.

Other components common to all reversal media were as follows. Concentrated NaCl and KCl were added to give final concentrations of 25 and 120 mM, respectively (Na added with ATP, ADP, phosphocreatine, and phosphoarginine was taken into account in the amount of concentrated NaCl that was added to bring the balance to 25 mM). The adenylate kinase inhibitor $A_{p5}A$, which has been shown not to interact with the Na,K-

ATPase (Cavieres and Glynn, 1979), was also incorporated at reversal. $40 \mu\text{M}$ $A_{p5}A$ was found to eliminate all residual adenylate kinase activity present in the ghosts. $^{24}\text{NaCl}$ at a final concentration of $4\text{--}20 \mu\text{Ci/ml}$ reversal suspension was also included in the reversal medium in order to measure the unidirectional efflux of Na.

After resealing, the doubly hemolyzed ghosts were washed once at 4°C with 5 vol of an NaCl wash solution (150 mM NaCl plus 10 mM HEPES, pH 7.4). In those cases where arginine had been incorporated at reversal, it was also present at the same concentration in all solutions to which the ghosts were subsequently exposed. A 50% suspension of the ghosts in the NaCl wash solution was then layered onto a sucrose cushion (42% sucrose, 50 mM NaCl, 10 mM HEPES, pH 7.4) and centrifuged at $48,000 g$ for 30 min at 4°C (see Bodemann and Passow, 1972). This procedure separated the ghosts into two distinct layers: one at the buffer-sucrose interface, the other at the bottom of the tube. The fraction of ghosts layered at the buffer-sucrose interface was harvested (the yield being $\sim 50\%$) and the ghosts were then washed three times at 4°C with 10 vol of the NaCl wash solution. Finally, the ghosts were packed for 15 min at $21,000 g$ in narrow Lucite centrifuge tubes, to be used immediately for Na efflux determination. (Several other separation techniques were tried, e.g., sucrose cushions of various densities, linear sucrose gradients, Percoll gradients, and different osmolalities, but no further decrease in the heterogeneity of the ghost population was achieved.)

In one experiment, ghosts were resealed to contain the phosphocreatine regenerating system but without ^{24}Na added. An aliquot of the reversed suspension was removed and assayed for total Na and K by flame photometry. The reversed suspension contained 30 mM Na and 130 mM K. The remaining ghosts were then processed exactly as described above. The inulin space of ghosts packed in the Lucite tubes was measured to be $\sim 25\%$. After correcting for the inulin space, the final content of the packed ghosts was 80 mM K/liter ghosts and 90 mM Na/liter ghosts. It should be noted that here, as in all experiments, ghosts were washed in the NaCl wash solution (K-free) before assay. Since, as pointed out later, the loss of ^{24}Na from ghosts follows a single exponential only after 5 min incubation, the packed ghosts are kinetically heterogeneous. Since they probably are also heterogeneous regarding their Na and K content, that is, Na entered and K was washed out of the leakier ghosts, the analysis presumably yields a minimum concentration for ghost K and a maximum concentration for ghost Na. Because of these uncertainties in the concentrations of ions within the ghosts, comparisons are presented in terms of Na efflux rate constants.

Na Efflux

As noted, ^{24}Na was incorporated into the ghosts at reversal. Measurements of ^{24}Na efflux were begun by adding $200 \mu\text{l}$ of a 50% ghost suspension to 6 ml of medium contained in an Erlenmeyer flask and transferring the flask to a shaker water bath at 37°C . Samples were removed at ~ 5 , 15, 25, and 35 min, the ghosts were pelleted by centrifugation (Eppendorff model 3200, Brinkmann Instruments, Westbury, NY), and the supernatants, as well as an equal volume of total suspension, were assayed for radioactivity in a gamma counter. Ouabain-sensitive Na efflux was measured in the presence and absence of external K. The 15 mM K medium (medium A) contained 15 mM KCl, 135 mM NaCl, and 10 mM HEPES, pH 7.4. The K-free medium (medium B) contained 150 mM NaCl and 10 mM HEPES, pH 7.4. Medium C is medium A plus 10^{-4} M ouabain and medium D is medium B plus 10^{-4} M ouabain. Thus, Na/K exchange was taken as the ouabain-sensitive efflux of Na from ghosts suspended in K-containing media, i.e., A minus C. Na/Na exchange was taken as the ouabain-sensitive efflux of Na from ghosts suspended in K-free media, i.e., B minus D. In a typical experiment, a single ghost preparation was divided

into four equal fractions before reversal, with each fraction resealed to contain a different nucleotide mixture. Effluxes for each nucleotide condition were performed in quadruplicate for each of the four medium conditions.

The rate constant for Na efflux was determined from a least-squares linear fit of the log transform of the radioactivity remaining in the ghosts. A rapid loss of radioactivity over the first 5 min of Na efflux was routinely observed (representing ~20% of the total counts) and only data obtained between 5 and 35 min, where the loss followed a single exponential, were used in the determination of the rate constant.

Nucleotide Determination

The concentrations of ATP, ADP, and AMP present in the ghosts were assayed in every experiment. For each nucleotide condition, a 2-ml sample of the efflux suspension was removed immediately before the 37°C incubation (zero time point), while a similar sample was taken after incubation for 35 min at 37°C in parallel with the efflux determination. The samples were placed in Pyrex test tubes and the enzymatic breakdown of nucleotides was immediately stopped by transferring the tubes to a boiling water bath. The samples were then stored at -20°C for up to 1 wk (while ²⁴Na activity decayed) and then assayed in triplicate for nucleotides by using the fluorometric methods described by Lowry and Passonneau (1972). All concentrations are expressed per liter of packed ghosts, without correction for extracellular medium in the packed ghost column.

RESULTS

This work concerns a characterization of the response of the Na/K pump to alterations in the composition of the adenine nucleotide pool, in a system where transport can be measured and where the mode of transport can be varied. Since the arginine kinase regenerating system is used to vary ADP at fixed concentrations of ATP, we first tested whether the inclusion of a primary constituent (arginine) of the nucleotide control system, per se, alters the operation of the pump. To evaluate the effects that arginine might have on the Na/K pump, arginine was incorporated into the ghosts at concentrations ranging between 0 and 35 mM. This was done in the presence of the creatine kinase regenerating system, which maintained ATP at a constant level high enough to run the pump at a brisk rate. Table I presents the results from four separate experiments. The addition of 12 mM arginine (the lowest concentration routinely used) evidently resulted in a small increase in the ouabain-sensitive Na efflux. However, further increases in the arginine concentration did not augment the effect. Nevertheless, it is possible that the effects attributed to ADP, as seen in Fig. 3, are slightly overestimated, while, on the other hand, the effects of ADP on Na/K exchange (see later) may be more pronounced than observed in these experiments.

Na/Na Exchange as a Function of ADP

It is known from previous work that Na/Na exchange requires the presence of ATP and is activated by ADP (Garrahan and Glynn, 1967c; Glynn and Hoffman, 1971; Cavieres and Glynn, 1979). Since these studies used the creatine kinase regenerating system, the concentration range over which ADP could be varied was limited. Having established that the arginine kinase system could be used to extend the ADP concentration range, we therefore studied the effects of ADP at different stable levels of ATP. Fig. 3 presents the dependence of Na/Na

exchange on the intracellular concentration of ADP. The ATP concentration is clamped at essentially the same level ($\sim 600 \mu\text{M}$) in all of the experiments summarized in this figure. The exchange is seen to increase to saturation with ADP. The apparent V_{\max} is 0.10 h^{-1} and the apparent $K_{1/2}^{\text{ADP}}$ is $370 \mu\text{M}$. The effect of ADP on Na/Na exchange was also determined at 370 and $1,000 \mu\text{M}$ ATP. In these cases, increasing the concentration of ADP also caused a stimulation of Na/Na exchange and in both cases the exchange rate also appeared to saturate. Table II lists the V_{\max} and $K_{1/2}^{\text{ADP}}$ values obtained at each ATP level. Because of the trend that increasing ATP increased V_{\max} (Table II), this point was further evaluated by studying the effects of altering the ATP concentration at relatively

TABLE I
Effect of Arginine on the Na/K Pump

Experiment	Ghost nucleotide			Na efflux rate constant			Percent change of control
	ATP	ADP	Arginine	Medium A (15 mM K)	Medium C (+ ouabain)	Ouabain-sensitive	
	μM	μM	mM	h^{-1}	h^{-1}	h^{-1}	
A	980	100	0	0.590 (0.013)	0.369 (0.011)	0.221	
	950	100	30	0.507 (0.007)	0.309 (0.015)	0.198	-10.4
B	770	70	0	0.683 (0.003)	0.373 (0.004)	0.310	
	580	90	12	0.677 (0.003)	0.294 (0.004)	0.383	23.5
	620	80	25	0.671 (0.019)	0.311 (0.006)	0.360	16.1
C	760	80	35	0.632 (0.003)	0.286 (0.011)	0.346	11.6
	730	80	0	0.751 (0.014)	0.442 (0.006)	0.309	
	670	70	12	0.813 (0.013)	0.420 (0.011)	0.393	27.2
	730	70	25	0.815 (0.004)	0.423 (0.001)	0.392	26.8
D	860	80	35	0.828 (0.010)	0.443 (0.009)	0.385	24.6
	740	40	0	0.923 (0.026)	0.713 (0.015)	0.210	
	720	60	12	0.919 (0.005)	0.681 (0.009)	0.238	13.3
	730	60	25	0.922 (0.016)	0.669 (0.011)	0.253	20.4
	730	60	35	0.913 (0.015)	0.646 (0.008)	0.267	27.1

The effect of arginine on ouabain-sensitive Na/K exchange in resealed ghosts containing the phosphocreatine regenerating system was carried out, in the presence of external Na, as described in Materials and Methods. The nucleotide concentrations are averages over a 35-min incubation at 37°C . Each Na efflux rate constant is the mean of four determinations, with the $\pm\text{SEM}$ given in parentheses. See text for further details.

constant levels of ADP. The results of four separate experiments where ATP was controlled at four different concentrations are shown in Table III. It is apparent that changing the concentration of ATP from ~ 100 to $1,800 \mu\text{M}$ did not appreciably alter Na/Na exchange.

Na/K Exchange as a Function of ATP

The extent of ouabain-sensitive Na/K exchange was determined in ghosts by measuring Na efflux in the presence of external K. To explore the effects of ATP at low ADP ($\sim 50 \mu\text{M}$) concentrations, we used the creatine kinase regenerating system. (The effects of high ADP concentrations, which involve the arginine kinase regenerating system, are taken up later.) Fig. 4 shows the

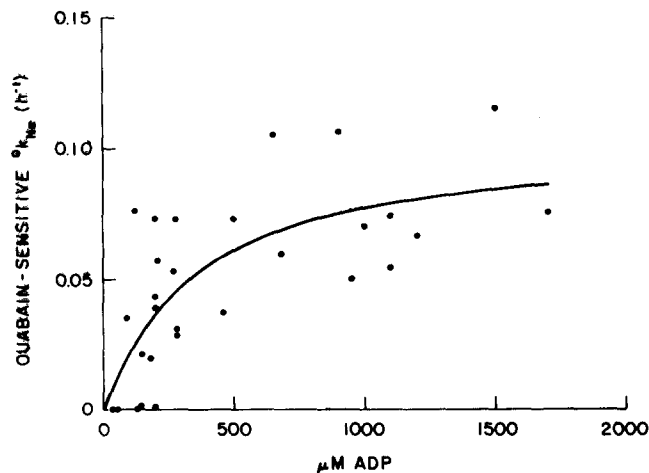

FIGURE 3. Na/Na exchange in resealed ghosts as a function of the intracellular ADP concentration. Ouabain-sensitive Na effluxes measured in the presence of ATP concentrations controlled within the range 500–750 μM with a mean concentration of 620 $\mu\text{M} \pm 20$ (SEM) are presented here. The total intracellular concentration of Mg was 3 mM in all cases. The phosphoarginine regenerating system was used to maintain constant ATP and ADP levels. Each point in the graph represents the difference between the means of quadruplicate determinations of the Na efflux rate constant, $\%k_{\text{Na}}$ (in reciprocal hours), measured in the absence and presence of ouabain. All Na efflux measurements were made in K-free, Na-containing media (media B and D). The curve represents the least-squares fit to the equation:

$$v = [\text{ADP}]V_{\text{max}}/([\text{ADP}] + K_{1/2}^{\text{ADP}}),$$

where V_{max} , the maximal velocity, was 0.106 (± 0.020) h^{-1} and where $K_{1/2}^{\text{ADP}}$, the substrate concentration for half-maximal activation, was 371 (± 172) μM (the numbers in parentheses are the standard deviations associated with the two parameters). The average Na efflux rate constant in the presence of ouabain was 0.319 ± 0.010 (SEM) h^{-1} . Ouabain-insensitive Na efflux slightly decreased as a function of ADP concentration (by $\sim 20\%$ over the ADP range examined in this figure).

TABLE II
Activation of Na/Na Exchange by ADP at Various Concentrations of ATP

Mean [ATP]	$V_{\text{max}} \pm \text{SD}$	$K_{1/2}^{\text{ADP}} \pm \text{SD}$
μM	h^{-1}	μM
370	0.096 \pm 0.013	118 \pm 67
620	0.106 \pm 0.020	371 \pm 172
990	0.182 \pm 0.027	374 \pm 139

Kinetic parameters characterizing the response of ouabain-sensitive Na/Na exchange to elevation of the ADP concentration were determined from the least-squares fit of the data to the Michaelis-Menten equation:

$$V = [\text{ADP}]V_{\text{max}}/([\text{ADP}] + K_{1/2}^{\text{ADP}}).$$

The results determining the kinetic parameters at 620 μM ATP are presented in Fig. 3, and experimental details are given in the legend to that figure. Analogous experiments were also performed at mean ATP concentrations of 370 and 990 μM .

activation of ouabain-sensitive Na/K exchange by ATP when the intracellular concentration of ATP was varied from 10 to 2,300 μM . It is evident that the Na/K pump-mediated efflux of Na increased to saturation. The apparent $K_{1/2}^{\text{ADP}}$ for this process, estimated from the results presented in Fig. 4, was $\sim 250 \mu\text{M}$. This value compares favorably with estimates of $K_{1/2}^{\text{ADP}}$ obtained by others for the low-affinity ATP site of human red cell ghosts and related systems measuring either Na/K translocation or Na,K-ATPase.

Thus, measurements on the ATP dependence of Na,K-ATPase activity of microsomal preparations (Neufeld and Levy, 1969; Kanazawa et al., 1970;

TABLE III
Effect of ATP on Na/Na Exchange

Experiment	Ghost nucleotide concentration		Na efflux rate constant		
	ATP	ADP	Medium B (K-free)	Medium D (+ ouabain)	Ouabain-sensitive
	μM	μM	h^{-1}	h^{-1}	h^{-1}
A	80	180	0.626 (0.006)	0.574 (0.009)	0.052
	260	190	0.687 (0.013)	0.618 (0.010)	0.069
	450	240	0.675 (0.011)	0.612 (0.008)	0.063
	640	290	0.699 (0.034)	0.636 (0.011)	0.063
B	160	210	0.634 (0.018)	0.513 (0.005)	0.121
	340	230	0.716 (0.010)	0.574 (0.007)	0.142
C	610	370	0.750 (0.008)	0.563 (0.009)	0.187
	800	390	0.767 (0.010)	0.564 (0.009)	0.203
D	540	110	0.490 (0.010)	0.463 (0.002)	0.027
	890	160	0.512 (0.006)	0.486 (0.003)	0.026
	1400	160	0.519 (0.019)	0.474 (0.012)	0.035
E	290	220	0.440 (0.025)	0.335 (0.006)	0.105
	530	210	0.482 (0.003)	0.401 (0.008)	0.081
	1170	270	0.501 (0.011)	0.429 (0.017)	0.072
	1770	370	0.516 (0.019)	0.393 (0.005)	0.123

The effect of varying the ATP concentration at stable levels of ADP on the rate of ouabain-sensitive Na/Na exchange in resealed ghosts was studied. All experiments were performed in the presence of external Na with ghosts containing the phosphoarginine regenerating system as described in Materials and Methods. Each rate constant is the mean of four separate determinations, with the $\pm\text{SEM}$ given in parentheses. Nucleotide values are averages taken over a 35-min incubation. See text for details.

Robinson, 1976b; Beaugé and DiPolo, 1981) have shown that ATP interacts with an apparent affinity that varies from 200 to 500 μM . Glynn and Karlsh (1976) studied Na,K-ATPase activity in porous ghosts and Eisner and Richards (1981) studied ouabain-sensitive Na/K exchange in resealed ghosts (containing a creatine kinase regenerating system to vary ATP levels) and found that the $K_{1/2}^{\text{ADP}}$ for the low-affinity site for ATP was $\sim 100 \mu\text{M}$, which is somewhat lower than that reported in the present work. The value of the $K_{1/2}^{\text{ADP}}$ obtained by Glynn and Karlsh (1976) and by Eisner and Richards (1981) was observed in low-Na media, where the external concentration of K (or Rb) was low (up to 1 mM) and presumably saturating. In addition, the ghost concentrations of internal Na and

K were also different from the concentrations used in our work. Whether these differences in ionic conditions on both sides of the membrane are responsible for the variation in the estimates for $K_{1/2}^{ADP}$ is not certain, but one could argue that the differences are in the expected direction. It should also be noted that Beaugé and DiPolo (1981) found a similar ATP affinity ($\sim 200 \mu\text{M}$) for the

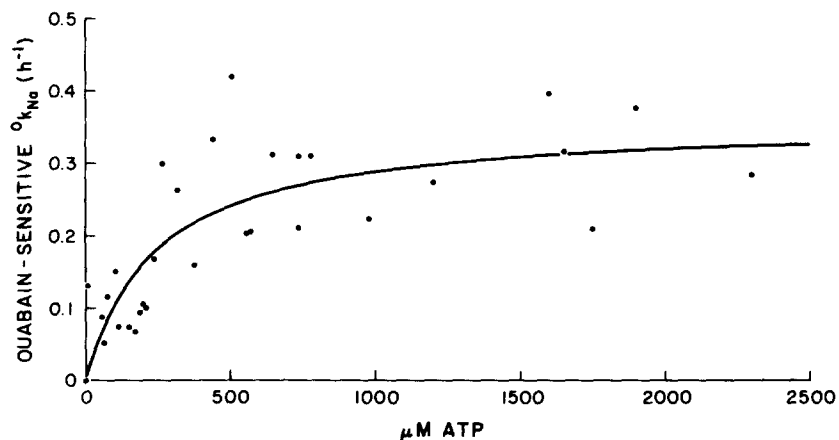

FIGURE 4. The effect of varying intracellular ATP on the extent of ouabain-sensitive Na/K exchange in resealed ghosts. Only experiments in which Na/K exchange was assayed in the presence of a low ADP concentration are presented here. The ouabain-sensitive Na efflux rate constant, ${}^0k_{\text{Na}}$, measured in the 15 mM K medium (medium A) is plotted as a function of the intracellular ATP concentration, where the mean ADP concentration was 57.9 ± 6.8 (SEM) μM and the mean AMP concentration was 2.4 ± 0.8 (SEM) μM . The efflux medium also contained Na. In all cases, the phosphocreatine regenerating system was used to maintain a constant ATP level in the presence of this low ADP concentration. The total concentration of intracellular Mg was 5 mM. The mean of quadruplicate Na efflux determinations in the presence of ouabain was subtracted from the mean of quadruplicate determinations in the absence of ouabain to determine each difference point plotted in the figure. The ATP concentrations given in the figure represent averages over a 30–35-min incubation period (at 37°C) run in parallel with the efflux determination. The curve is the least-squares fit to the equation:

$$v = [\text{ATP}]V_{\text{max}}/([\text{ATP}] + K_{1/2}^{\text{ADP}}),$$

where V_{max} was $0.364 (\pm 0.042) \text{ h}^{-1}$ and $K_{1/2}^{\text{ADP}}$ was $254 (\pm 91) \mu\text{M}$ (numbers in parentheses are standard deviations). The average efflux rate constant in the presence of ouabain was 0.339 ± 0.019 (SEM) h^{-1} . Ouabain-insensitive Na efflux was also examined as a function of the ATP concentration and there was no significant correlation between the two variables.

dependence of Na efflux from internally dialyzed squid giant axons. From these types of studies, it seems clear that there is an equivalence between assaying the Na/K pump activity as Na,K-ATPase in an unsealed preparation and ion movements across an intact membrane.

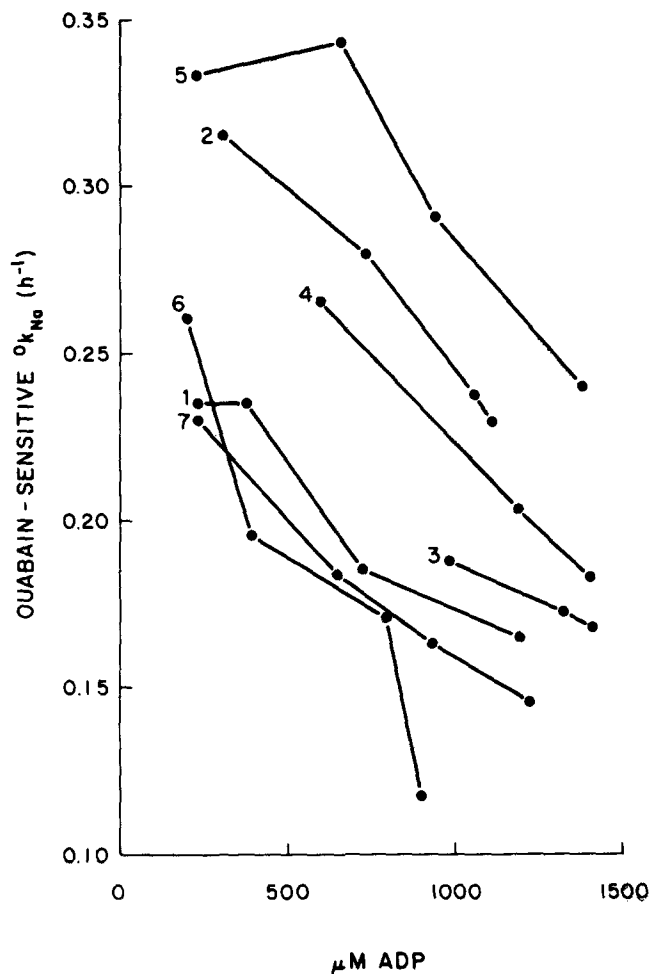

FIGURE 5. The effect of varying the concentration of intracellular ADP, at constant ATP, on ouabain-sensitive Na/K exchange, in a medium containing both Na and K. The ouabain-sensitive outward rate constant, ${}^0k_{Na}$, was determined as described in Materials and Methods. The concentration of Na was 135 mM and the external K was 15 mM in the experiments shown here. (In the few experiments where the K concentration was increased to 50 mM, at the expense of external Na, similar results were obtained.) Straight lines connect points obtained in the same experiment. The phosphoarginine regenerating system was used to control ADP and ATP levels at preset concentrations. The mean ATP concentration was 472 ± 24 (SEM) μM for the 26 conditions. In any one experiment, each value for the ATP concentration in the ghosts was within 15% of the mean for the particular experiment. The average rate constant for ouabain-insensitive Na efflux was 0.446 ± 0.011 (SEM) h^{-1} . There was a significant negative correlation between the ouabain-insensitive flux and increasing ADP (or possibly increasing arginine, but see Table I) concentration. This effect was not large, being on the average an $\sim 15\%$ decrease over the maximal range of ADP concentrations examined in these experiments.

Na/K Exchange as a Function of ADP

Ouabain-sensitive Na/K exchange was found to decrease as the concentration of intracellular ADP was increased. The results from seven separate experiments illustrating this effect are presented in Fig. 5. The ADP concentration was varied from ~200 to 1,500 μM under conditions where the base level of ATP was held at ~500 μM (see figure legend). Three or four different ADP concentrations were studied in each experiment, as indicated in the figure by the connected points. The effect of increasing the concentration of ADP is marked, with inhibition observed in each instance. The maximal mean decrease in Na/K exchange was 35% in these experiments.

These results contrast with the results of previous work on frog skeletal muscle (Kennedy and De Weer, 1977) and on squid giant axon (De Weer et al., 1979),

TABLE IV
Effect of Varying ADP Concentration on the Rate of Na/K Exchange at High Values of Intracellular ATP, in the Presence of External Na

Experiment	Ghost nucleotide concentration		Na efflux rate constant		
	ATP	ADP	Medium A (15 mM K)	Medium C (+ ouabain)	Ouabain-sensitive
	μM	μM	h^{-1}	h^{-1}	h^{-1}
A	790	120	0.872 (0.048)	0.596 (0.007)	0.276
	730	230	0.867 (0.012)	0.549 (0.017)	0.318
	730	570	0.873 (0.010)	0.587 (0.020)	0.286
B	820	200	0.762 (0.016)	0.472 (0.003)	0.290
	710	320	0.755 (0.014)	0.420 (0.011)	0.335
	750	430	0.732 (0.023)	0.460 (0.012)	0.272
C	750	290	0.640 (0.027)	0.420 (0.015)	0.220
	890	510	0.588 (0.017)	0.392 (0.023)	0.196
	880	720	0.550 (0.025)	0.350 (0.018)	0.200

All experiments were performed with the phosphoarginine regenerating system as described in Materials and Methods. The nucleotide concentrations are averages over a 35-min incubation. Each Na efflux rate constant is the mean of four separate efflux determinations, with the $\pm\text{SEM}$ given in parentheses. Further details are given in the text.

where no significant inhibition of ouabain-sensitive Na/K exchange was observed when ADP was elevated. In those preparations, quantitation of ATP and ADP levels is difficult, but it is almost certain (Kennedy and De Weer, 1977; De Weer et al., 1979) that the concentration of ATP was higher than that present in the experiments summarized in Fig. 5. Thus, it was of interest to determine whether the inhibitory effects of elevated ADP concentration also occurred at higher levels of ATP. As shown in Table IV, in the presence of a higher ATP concentration (almost 1 mM), Na/K exchange was virtually unaffected by changes in the concentration of ADP over the range of ~100–700 μM . This may be due to the fact that the absolute level of ATP, as well as the ATP/ADP ratio, was higher than those studied in connection with Fig. 5. However, because of

limitations imposed by the arginine kinase regenerating system, higher concentrations of ATP and/or ADP could not be examined. In any case, the extent of ADP inhibition of Na/K exchange seemed to be affected by the relative ATP concentration.

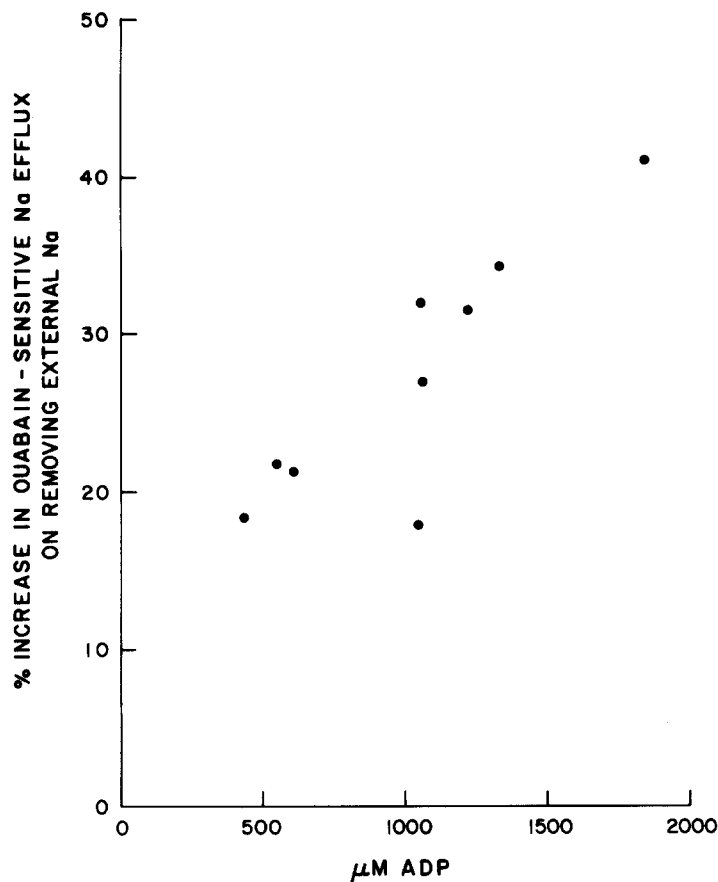

FIGURE 6. The percent stimulation of ouabain-sensitive Na efflux caused by removal of external Na, as internal ADP is increased. The ouabain-sensitive efflux rate constant for Na, ${}^{\circ}k_{Na}$, was determined at 37°C in the presence and absence of external Na, as described in Materials and Methods. The Na-containing medium (A) contained 135 mM NaCl, 15 mM KCl, and 10 mM HEPES (pH 7.4). The Na-free medium (B) contained 135 mM choline Cl, 15 mM KCl, and 10 mM HEPES (pH 7.4). Each point represents the percent change in the ouabain-sensitive Na flux components calculated according to the equation:

$$\frac{({}^{\circ}k_{Na})_B - ({}^{\circ}k_{Na})_A}{({}^{\circ}k_{Na})_A} \times 100.$$

The phosphoarginine regenerating system was used to set and maintain ADP and ATP concentrations. The mean ATP concentration was $651 \pm 58 \mu\text{M}$ (\pm SEM). Intracellular Mg concentration was 5 mM.

Na/K Exchange as a Function of External Na

It has been found previously that, in intact human red cells, the ouabain-sensitive efflux of Na into a medium containing sufficient K (e.g., 15 mM) to saturate the Na/K pump is essentially not affected by the removal of external Na (Sachs, 1970; Hoffman, J. F., unpublished experiments). In view of the foregoing results (Fig. 5), it could be argued that the inability to see an effect of external Na was

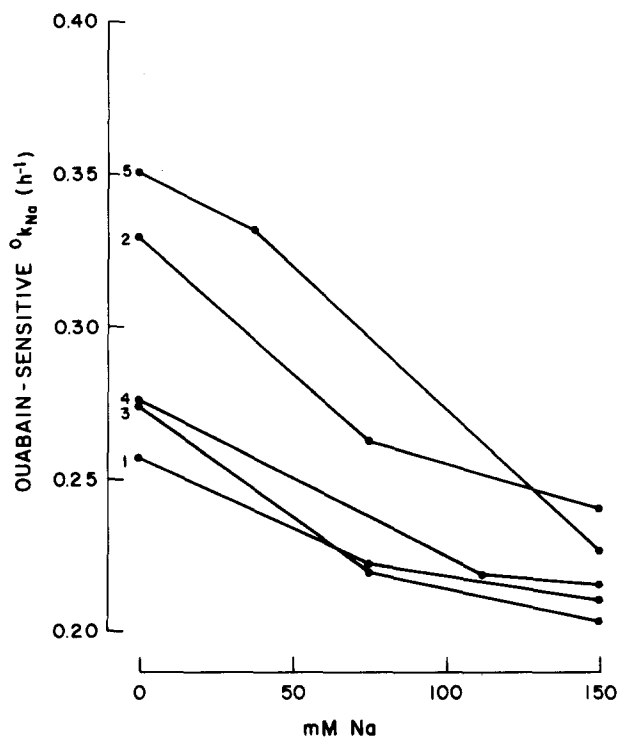

FIGURE 7. Inhibition of ouabain-sensitive Na efflux by elevation of external Na at a controlled preset ratio of ATP/ADP. The ouabain-sensitive Na efflux rate constant, ${}^0k_{Na}$, was determined in media containing various concentrations of Na, as described in Materials and Methods. The external medium consisted of 135 mM NaCl, 15 mM KCl, 10 mM HEPES (pH 7.4) with equiosmolar substitution by choline(Cl) used to lower the external Na(Cl) concentration. Straight lines connect points determined in a single experiment. The phosphoarginine regenerating system was used to control preset ADP and ATP concentrations. The mean ATP concentration was 560 ± 50 (\pm SEM) μ M and the mean ADP concentration was $1,040 \pm 70$ (\pm SEM) μ M. Intracellular Mg was 5 mM.

due to a high ratio of ATP to ADP. This in fact turns out to be the case, as shown by the results of the experiments illustrated in Fig. 6. Each point was determined from the difference in the ouabain-sensitive Na efflux rate constants measured in the presence and absence of external Na (choline substituted for an osmotically equivalent concentration of Na). The results are presented as the percent increase in Na/K exchange produced by removal of external Na. It is

apparent that the stimulation of the ouabain-sensitive component increases as the concentration of internal ADP increases. It should be mentioned that the effect of removal of external Na was comparable when K rather than choline was used to substitute for Na (data not shown).

To examine further the effect of external Na on the Na/K pump, additional experiments were carried out in which the ouabain-sensitive Na efflux was assessed at three different external Na concentrations, each in the presence of 20 mM external K. In these experiments, the nucleotide levels were preset with the phosphoarginine regenerating system to contain $\sim 550 \mu\text{M}$ ATP and $1,000 \mu\text{M}$ ADP. The results are presented in Fig. 7, which shows that the inhibition of

TABLE V
Effects of Varying the Concentration of Free Mg on Ouabain-sensitive Na/K Exchange

Experiment	Total substrate concentration			Computed concentrations			Na efflux rate constant		
	Mg	ATP	ADP	MgATP	MgADP	Free Mg	Medium A (15 mM K)	Medium C (+ ouabain)	Ouabain-sensitive
	<i>mM</i>	<i>mM</i>	<i>mM</i>	<i>mM</i>	<i>mM</i>	<i>mM</i>	h^{-1}	h^{-1}	h^{-1}
A	1.00	0.69	0.09	0.56	0.03	0.42	0.443 (0.010)	0.232 (0.017)	0.211
	2.00	0.64	0.08	0.60	0.05	1.36	0.452 (0.020)	0.238 (0.012)	0.214
	4.00	0.57	0.08	0.55	0.06	3.39	0.494 (0.015)	0.264 (0.011)	0.230
	6.00	0.52	0.07	0.51	0.06	5.44	0.454 (0.025)	0.237 (0.005)	0.217
B	0.65	0.65	0.12	0.43	0.02	0.20	0.476 (0.005)	0.244 (0.019)	0.232
	1.60	0.65	0.14	0.58	0.07	0.95	0.496 (0.009)	0.256 (0.019)	0.240
	3.50	0.72	0.12	0.70	0.09	2.72	0.539 (0.008)	0.286 (0.010)	0.253
	5.40	0.52	0.11	0.51	0.09	4.80	0.516 (0.009)	0.271 (0.012)	0.245

Both experiments were performed using the phosphocreatine regenerating system. Total Mg concentration refers to the Mg concentration incorporated at reversal. Stability constants were $10,000$ and $1,026 \text{ M}^{-1}$ for MgATP and MgADP, respectively (Alberty, 1969). Free Mg refers to Mg not complexed to ATP or ADP. Total nucleotide concentrations were determined by assay of samples taken simultaneously with efflux determination. Each efflux rate constant for Na is the mean of four separate determinations given with the \pm SEM in parentheses. The ouabain-sensitive rate constant for Na efflux was determined, in media containing Na and K, as the difference between the rate constants in the absence and presence of 10^{-4} M ouabain.

the ouabain-sensitive Na efflux is proportional to the concentration of external Na, with the fractional inhibition increasing as Na is increased. Some implications of these results will be considered in the Discussion.

Na/K Exchange as a Function of Free Mg

In all of the experiments described above, the total internal Mg concentration of the ghosts was preset at either 3 or 5 mM, even though the total nucleotide concentration varied from $\sim 100 \mu\text{M}$ to 2 mM. Since both ATP and ADP complex Mg, the concentrations of free Mg necessarily vary, depending upon the nucleotide composition and concentration. It was therefore of interest to estimate how changes in free Mg levels may have influenced the results described above. To this end, ghosts, after hemolysis, were divided into four parts, each of which was then resealed to contain a different Mg concentration. Total ATP and ADP

levels were measured, and free Mg, MgATP, and MgADP levels were then computed. As shown in Table V, MgATP was essentially constant for all conditions in either one of the two experiments. Free Mg levels were varied from ~0.5 to 5.0 mM to encompass approximately the maximal range encountered in the experiments described in this work. Over this range of Mg concentration, it can be seen that no significant effects on Na/K exchange were observed.

It should be noted that variations in free Mg can alter Na/K pump activity. For instance, Bodemann and Hoffman (1976) found that increasing internal Mg activated the Na/K pump, but the levels of Mg were probably much lower than those employed here (see recalculated Mg values in Hoffman, 1978). On the other hand, Flatman and Lew (1981) altered Mg levels in intact cells (with the divalent ionophore A23187) over a more extensive range than that studied in the present work. They found, like Bodemann and Hoffman (1976), that the Na/K pump was activated by increasing the free Mg concentration up to ~0.5 mM. However, Flatman and Lew (1981) found that further increases in the free Mg concentration, over the computed range examined here, inhibited Na/K exchange by ~30% (also compare De Weer, 1976). Whether these discrepant results reflect differences between intact cells and ghosts, or differences in ATP concentration and other possible intracellular complexing agents, and/or differences in the methods used to estimate the free Mg concentrations cannot be settled without further work.

DISCUSSION

The main purpose of this work was to evaluate the effects of varying the ATP and ADP concentrations on the magnitude of ouabain-sensitive Na/K and Na/Na exchange in resealed human red cell ghosts. We used techniques by which ATP levels could be varied at fixed concentrations of ADP and by which ADP could be varied at fixed concentrations of ATP under conditions where any ATP/ADP ratio could be clamped over the time period necessary to assay pump function. This was made possible by effectively eliminating adenylate kinase activity in the ghosts through extensive dilution of their intracellular contents, coupled with the use of the inhibitor $A_{p5}A$, and by incorporating a nucleotide regenerating system to provide for the control of stable ATP levels in the presence of ongoing ATPase activity.

The principle findings of this study are as follows. (a) For Na/Na exchange, (i) the flux increases to saturation with increasing concentrations of ADP (Fig. 3), and (ii) the $K_{1/2}^{ADP}$ for ADP is not particularly sensitive to the concentration of ATP (Tables II and III). (b) For Na/K exchange, (i) the flux increases to saturation with increasing concentrations of ATP at low values of ADP (Fig. 4), and (ii) at saturating concentrations of external K, increasing ADP at constant levels of ATP decreases the rate of Na/K exchange (Fig. 5). This effect of ADP is seen at low but not at high values of ATP (Table IV). (c) At a fixed low concentration of ATP, Na/K exchange is inhibited by external Na in proportion to the ADP level (Fig. 6), and at high ADP levels, it is inhibited in proportion to the concentration of external Na (Fig. 7).

Before discussing these points in more detail, it is of interest to consider the

results from a different perspective by viewing them from a thermodynamic standpoint. Since, as expressed by Lipmann (1960), the free energy available from the hydrolysis of ATP varies as a function of the phosphoryl potential (taken here as the ratio ATP/ADP, at constant AMP, P_i , Mg, and pH), changes in the ATP/ADP ratio might be expected to alter the characteristics of any ATP-consuming process such as the Na/K pump. In particular, since decreasing the ATP/ADP ratio decreases the free energy available for the translocation of the ions, this could be reflected as a decrease in the rate of transport as ADP is increased relative to ATP, which is in fact what was observed (Fig. 5). The effects of altering the concentration of Na across the membrane (as in Figs. 6 and 7) can be explained by the fact that when the phosphoryl potential is low, the pump can run only under conditions where less energy is required. For the circumstance where the Na gradient is oriented outward, Na may still be transported against an electrical potential (inside negative relative to outside), but we have not as yet evaluated the effects of variations in membrane potential at different settings of the phosphoryl potential. On the other hand, we also expect to explore more extensively the effects of changes in the phosphoryl potential when it is altered by varying the concentration of P_i at constant ratios of ATP to ADP. Preliminary (but variable) findings indicate that the addition of 10 mM P_i to ghosts containing relatively modest ratios of ATP to ADP results in the inhibition of ouabain-sensitive Na/K exchange.

The above analysis, of course, is limited because it states the case without reference to the possible detailed mechanisms that could be involved. We can consider the effects of varying ATP, ADP, and Na more specifically by referring to a reaction scheme such as that shown in Fig. 8. (An expanded version of this scheme and the rationale for the inclusion of the various phosphorylated intermediates is extensively discussed by Glynn, 1985.) Four steps are indicated in Fig. 8, labeled I, II, III, and IV, that appear to be focal points for providing explanations for the results reported in this paper. It should be noted that at steps I and IV, ADP is taken to act as a competitive inhibitor with ATP, while at steps II and III, ADP and external Na act, respectively, as product inhibitors. Presumably, as suggested by Post et al. (1972), the principal rate-limiting step in the overall cycle is the release of occluded K, from the $E_2(K)$ form, from the inner surface of the pump to the cytoplasm (see Glynn and Richards, 1982, for references). ATP acts at its low-affinity site to accelerate the release of this K (step IV) in the transport processes that involve K, such as Na/K exchange (results presented in Fig. 4; Glynn and Karlisch, 1976; Beaugé and Glynn, 1980; Eisner and Richards, 1981; Beaugé and DiPolo, 1981) and K/K exchange (Simons, 1974). It is reasonable to assume that ADP might also act at step IV to affect these transport processes by competing with ATP at its low-affinity site.

It was shown in Fig. 5 that ADP acts to inhibit ouabain-sensitive Na/K exchange with a rather low affinity. It is possible that this effect of ADP involves competition with ATP at either step I or step IV. If competition occurs at step I, then the high-affinity site for ATP interaction would necessarily be involved. Hegyvary and Post (1971) and Nørby and Jensen (1971) determined from equilibrium binding measurements that the Na/K-ATPase, in the absence of Mg, bound

ATP with a high affinity ($K_d = 0.1\text{--}0.2\ \mu\text{M}$) and ADP with a 5–10 times lower affinity ($K_d = 0.5\text{--}2\ \mu\text{M}$). Perhaps more to the point, Sakamoto and Tonomura (1980) have studied the effects of ADP on Na,K-ATPase at 37°C in the presence of 15 mM K and 10 mM MgCl₂. They found that ADP is a competitive inhibitor of Na,K-ATPase at both low (0.5–32 μM) and high (50–400 μM) concentrations of ATP. The values for K_m^{ATP} in the low and high concentration ranges were, respectively, 1.36 and 290 μM ; the corresponding values for K_i^{ADP} were 73 and

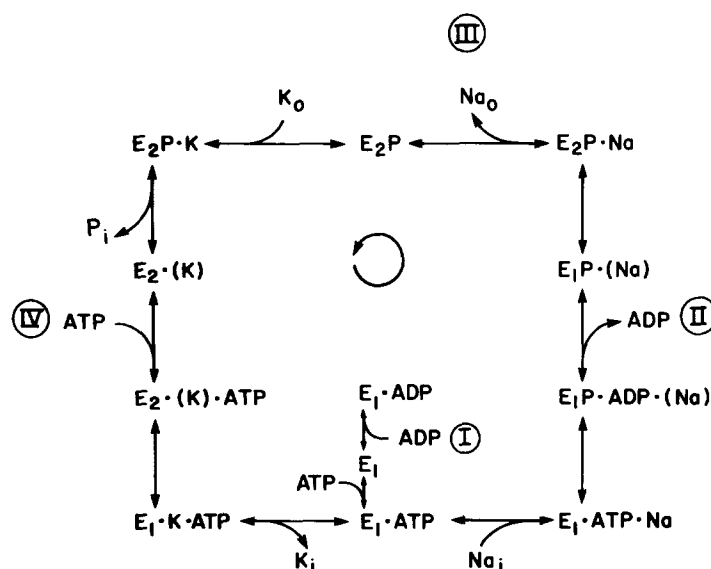

FIGURE 8. A consecutive model for the mechanism of the Na/K pump. The symbols E_1 , E_2 , E_1P , and E_2P refer to different conformations of the unphosphorylated and phosphorylated forms of Na,K-ATPase (E), respectively. The subscripts i and o refer, respectively, to ions located inside and outside the membrane. The enclosure of Na and K in parentheses represents occluded forms of these ions, that is, bound ions that are inaccessible to the inside or outside phase. Steps labeled I, II, and IV denote reactions that can be affected by ADP. Step I represents the high-affinity binding sites and step IV represents the low-affinity nucleotide binding sites. Step III indicates where external Na is involved as discussed in the text. The Na/K pump normally operates in the counterclockwise direction. Evidence supporting the various phosphorylated forms is reviewed by Glynn (1985). (Scheme modified from Karlisch et al., 1978.)

430 μM . Since, as seen in Fig. 5, ADP exerts its inhibitory effects at concentrations only two to three times that of ATP, it is unlikely, although still possible, that the high-affinity site (step I) is involved.

It thus seems more likely that the competitive effects of ADP with ATP occur at the low-affinity site (step IV). In addition to Sakamoto and Tonomura (1980), Hexum et al. (1970) and Robinson (1976a) have also shown that ADP acts as a competitive inhibitor of ATP activation of Na,K-ATPase. Beaugé and Glynn (1979) showed that ADP as well as ATP could release occluded K from the

enzyme. Furthermore, measurements of intrinsic fluorescence indicated that a K-induced conformational change of the enzyme could be reversed with either ADP or ATP (Beaugé and Glynn, 1980). In addition, activation of Na,K-ATPase by ADP at low concentrations of ATP in the presence of K has been observed by Mone and Kaplan (1982), and it has also been found that ADP can substitute for ATP in promoting K/K exchange (Kaplan and Kenney, 1982). Both types of results imply that ADP can act like ATP to release K from an occluded form (see Glynn and Richards, 1982). These various studies support the idea that the inhibition of the Na/K pump produced by increasing ADP (Fig. 5) could be, at least in part, due to ADP acting at step IV, provided that ADP is less effective than ATP in promoting K release. This presumably means that the conversion of $E_2(K)$ ADP to its E_1 form is slower than that for $E_2(K)$ ATP [perhaps for the reason that ADP has to come off of $E_2(K)$ ADP before ATP can bind, whereas $E_2(K)$ ATP can cycle directly to E_1 ATP]. Since these comparative rates have yet to be evaluated under our conditions (but see Glynn and Richards, 1982; Forbush, 1984), it is not possible to distinguish between steps I and IV as the site for ADP's inhibitory effects. Perhaps both sites are involved. It should be noted, however, that the inhibitory effect of ADP is dependent on the concentration of ATP since the effect is not apparent when the ATP concentration approaches the millimolar range (see Table IV). Presumably this is the reason that Kennedy and De Weer (1977) observed little effect on Na/K exchange when internal ADP was elevated in frog skeletal muscle. As already mentioned, we were prevented for technical reasons from studying the effects of high ADP concentrations at high levels of ATP.

As previously noted, step IV is not the only place in the enzyme cycle that is sensitive to ADP. Certainly for the effects in releasing occluded K, step IV is crucial. However, it is also possible that ADP could act at step II to modulate the inhibitory effects of external Na, acting at step III, on the transport of Na by the pump as presented in Figs. 6 and 7. In this instance, the Na/K pump is stimulated by the removal of external Na, with the stimulation increasing as the concentration of ADP is increased relative to that of ATP. It should be emphasized that these effects of ADP and external Na are dependent upon the presence of a saturating concentration of external K. Since high ADP only alters Na efflux when K_o is present, the action of ADP at step II presumably must be affected by K_o , separately from the involvement of K_o in K translocation. The scheme, as presented in Fig. 8, is inadequate to account for these effects because no explicit role is cast for either Na_o or K_o . We therefore suggest that the scheme as depicted in Fig. 8 be modified to include enzyme intermediates where both external Na (Na_o^*) and external K (K_o^*) are or can be liganded for either transient or permanent occupancy during the reaction cycle, depending on the levels of the different nucleotides and the concentration and species of ions present on the two sides of the membrane. The asterisk indicates a liganded ion and the subscript indicates the sided origins of the bound ion. K_o^* is needed to provide the signal for the pump to operate, exchanging K_o for Na_i as opposed to, say, Na/Na exchange. Na_o^* provides for the sensitivity, in the presence of K_o , of the Na/K pump to the combination of Na_o and high ADP. Although it is impractical to

specify which intermediates contain Na_o^* and K_o^* , or whether all of them do, the presumption is that these ions are liganded to modulatory sites that, in themselves, may or may not exist throughout the cycle. Evidence for Na_o (and K_o) binding to external modulatory sites has been provided by Sachs (1974, 1977), Cavieres and Ellory (1975), and Hobbs and Dunham (1976, 1978). The inclusion of the forms Na_o^* and K_o^* is not meant to imply bias as to the underlying reaction mechanism, that is, whether the reaction is ping-pong or not (see Garrahan and Garay, 1976). Thus, K_o^* could be bound to a modulatory site or to a former Na site without being transported inward. This could imply that one Na (out of the three that are transported) is released and a K_o^* is bound before the remaining Na ions are released. External K could be bound for inward transport either after or before the release of bound Na. (Another instance in human red cells that indicates the possible existence of a form where [some] K is bound before [all] Na is released is the modulation by external K of vanadate's effects on the Na/K pump [see Beaugé and Berberian, 1983]).

Thus, while ADP competes with ATP at step IV, ADP could act as a product inhibitor at step II to slow the conversion of an E_1 -type form to an E_2P -type form with the subsequent release of occluded Na. The distribution of the various enzyme forms, whether phosphorylated or not, that attend the $\text{E}_1\text{P} \rightleftharpoons \text{E}_2\text{P}$ steady state, which is normally poised in the E_2 direction when ADP is low, is presumably reversed or shifted to the left when the concentration of ADP is raised. This is to say that the relative concentration of any of the E_1 forms below step II could be changed by increasing the concentration of ADP or, alternatively, that the relative turnover of these forms is slowed in this situation. Unfortunately, there is no direct evidence that bears on this interpretation because the studies that are available have been carried out in K-free media. In the absence of external K, the effects of increasing ADP in promoting Na/Na exchange, such as those presented in Fig. 3 (see also Glynn and Hoffman, 1971), have been shown to occur in concert with promoting ATP-ADP exchange (Cavieres and Glynn, 1979; Kaplan and Hollis, 1980; Kaplan, 1982; Cavieres, 1983). This kind of shift toward E_1 forms has also been demonstrated, again in the absence of K, to be promoted by increasing concentrations of Na (Hara and Nakao, 1981). However, whether in the presence of external K the combinations of external Na and high ADP act in an analogous way to reduce the levels of the E_2P forms that involve Na, to account for the inhibition of the Na/K pump, cannot be stated at this time. However, if under the conditions of high K_o , high Na_o , and ADP, the net release of Na is hindered (step III), because the forms involved in the $\text{E}_1\text{P} \rightleftharpoons \text{E}_2\text{P}$ steady state are shifted toward the E_1 forms, then the cycle would be rate-limited at steps II and III rather than at step IV (and/or step I). Relief of this switch in the rate-limiting sequence of reactions would then be obtained by removing external Na. This explanation implies that ADP acts with greater effect at step IV (and/or step I) to retard K release or $\text{E}_1 \cdot \text{ATP}$ generation than at step II to slow the conformational changes, because Na/K exchange is accelerated either by removing external Na (Fig. 6) and/or by increasing ATP relative to ADP (Table IV). It should be noted that in contrast to the competition between ATP and ADP at step IV (and/or step I), this kind of interaction

presumably is less likely to occur at step II since the $K_{1/2}^{ADP}$ for Na/Na exchange appears to be relatively insensitive to changes in this concentration range of ATP (see Table II).

A critical and tacit assumption contained in the above analysis is that K influx is saturated at the concentrations of external K (15 mM) used in our experiments. We use saturation here to mean that ouabain-sensitive Na efflux is not limited by the concentration of external K, for we have found that this rate remains constant when medium K is raised from 15 to 50 mM (data not shown). This implies that no Na/Na exchange occurs, even at high concentrations of ADP. This has not yet been determined for our conditions, but it should be mentioned that the ouabain-sensitive Na influx into intact red cells was almost, but not completely, eliminated when external K was increased to saturation (Garrahan and Glynn, 1967*b*; Sachs, 1970). If Na/Na exchange were promoted to any appreciable extent by raising internal ADP, for instance, in the type of experiment depicted in Fig. 5, then the modulating role of ADP suggested for step IV (and/or step I) could be shifted to step II. If Na/Na exchange were not stimulated (that is, if Na influx were not increased by increasing ADP), then we would expect K influx to increase when Na was removed from the external medium. So far, ghost heterogeneity has prevented us from being able to accurately evaluate either Na or K influx under the appropriate intracellular conditions.

Finally, we can consider whether the ghost concentrations of ADP and ATP as referred to in this paper precisely reflect the concentrations of these nucleotides in the immediate proximity of the inner face of the Na/K pump. There is now substantial evidence (Parker and Hoffman, 1967; Okonkwo et al., 1975; Segel et al., 1975; Proverbio and Hoffman, 1977; Mercer and Dunham, 1981) indicating that ATP (and ADP) may be compartmentalized within the regional domain of the pump. ATP pooled within this membrane compartment appears to be used preferentially with regard to cytoplasmic ATP as the proximate substrate of the pump. There is a flow (exchange) of nucleotides between cytoplasm and membrane pool (see Proverbio and Hoffman, 1977; Mercer and Dunham, 1981), but the rates of this kind of equilibration are not known. However, membrane pool ATP seems to come into play when the pump activity has been increased above its resting rate by increasing the concentration of intracellular Na (see Parker and Hoffman, 1967), which indicates that local synthesis of ATP from ADP within the pool (carried out by reaction with membrane-bound phosphoglycerate kinase) occurs at a rate faster than cytoplasmic ATP can gain entry. It is not possible to estimate the extent to which this situation may obtain in our experiments when the Na content of the ghosts is high but when the operating rate of the Na/K pump is down-regulated by having high ADP at relatively low values of ATP. However, it should be kept in mind that the nucleotide ratio present in the membrane compartment may not be the same as the measured nucleotide ratios that define the cytoplasmic if not the total concentration of ATP and ADP.

We wish to thank John Barbaria, Jean Milton, and Paul Singer for their technical help during the course of this work. We also thank Bliss Forbush III and Mark Milanick for their comments on the manuscript and Ian M. Glynn for helpful discussions.

This work was supported in part by National Institutes of Health grants HL-09906 and AM-17433. B.G.K. was also supported by National Institutes of Health Fellowship AM-06000.

Original version received 8 August 1983 and accepted version received 29 July 1985.

REFERENCES

- Alberty, R. A. 1969. Standard Gibbs free energy, enthalpy and entropy changes as a function of pH and pMg for several reactions involving adenosine phosphates. *Journal of Biological Chemistry*. 224:3290-3302.
- Baker, P. F., M. P. Blaustein, R. D. Keynes, J. Manil, T. I. Shaw, and R. A. Steinhardt. 1969. The ouabain-sensitive fluxes of sodium and potassium in squid giant axons. *Journal of Physiology*. 200:459-496.
- Beaugé, L. A., and G. Berberian. 1983. The effects of several ligands on the potassium-vanadate interaction in the inhibition of the (Na⁺+K⁺)-ATPase and the Na⁺,K⁺ pump. *Biochimica et Biophysica Acta*. 727:336-350.
- Beaugé, L., and R. DiPolo. 1981. The effects of ATP on the interactions between monovalent cations and the sodium pump in dialyzed squid axons. *Journal of Physiology*. 314:457-480.
- Beaugé, L. A., and I. M. Glynn. 1979. Occlusion of K ions in the unphosphorylated sodium pump. *Nature*. 280:510-512.
- Beaugé, L. A., and I. M. Glynn. 1980. The equilibrium between different conformations of the unphosphorylated sodium pump: effects of ATP and of potassium ions, and their relevance to potassium transport. *Journal of Physiology*. 299:367-383.
- Bodemann, H. H., and J. F. Hoffman. 1976. Effects of Mg and Ca on the side dependencies of Na and K on ouabain binding to red blood cell ghosts and the control of Na transport by internal Mg. *Journal of General Physiology*. 67:547-561.
- Bodemann, H., and H. Passow. 1972. Factors controlling the resealing of the membrane of human erythrocyte ghosts after hypotonic hemolysis. *Journal of Membrane Biology*. 8:1-26.
- Brinley, F. J., and L. J. Mullins. 1968. Sodium fluxes in internally dialyzed squid axons. *Journal of General Physiology*. 52:181-210.
- Cavieses, J. D. 1977. The sodium pump in human red cells. In *Membrane Transport in Red Cells*. J. C. Ellory and V. Lew, editors. Academic Press, Inc., New York. 1-37.
- Cavieses, J. D. 1983. Ouabain-sensitive ATP-ADP exchange and Na-ATPase of resealed red cell ghosts. *Current Topics in Membranes and Transport*. 19:677-681.
- Cavieses, J. D., and J. C. Ellory. 1975. Allosteric inhibition of the sodium pump by external sodium. *Nature*. 255:338-340.
- Cavieses, J. D., and I. M. Glynn. 1979. Sodium-sodium exchange through the sodium pump: the roles of ATP and ADP. *Journal of Physiology*. 297:637-645.
- De Weer, P. 1970. Effect of intracellular adenosine-5'-diphosphate and orthophosphate on the sensitivity of sodium efflux from squid axon to external sodium and potassium. *Journal of General Physiology*. 56:583-620.
- De Weer, P. 1976. Axoplasmic free magnesium levels and magnesium extrusion from squid giant axons. *Journal of General Physiology*. 68:159-178.
- De Weer, P., B. G. Kennedy, and R. F. Abercrombie. 1979. Relationship between Na:K exchanging and Na:Na exchanging modes of operation of the sodium pump. In *Na,K-ATPase, Structure and Kinetics*. J. C. Skou and J. G. Nørby, editors. Academic Press, Inc., London. 503-515.
- Eisner, D. A., and D. E. Richards. 1981. The interaction of potassium ions and ATP on the sodium pump of resealed red cell ghosts. *Journal of Physiology*. 319:403-418.

- Flatman, P. W., and V. L. Lew. 1981. The magnesium dependence of sodium-pump-mediated sodium-potassium and sodium-sodium exchange in intact human red cells. *Journal of Physiology*. 315:421-446.
- Forbush, B., III. 1984. Rapid release of occluded ^{86}Rb from the Na pump. *Biophysical Journal*. 45:76a. (Abstr.)
- Garrahan, P. J., and R. P. Garay. 1976. The distinction between simultaneous and sequential models for sodium and potassium transport. *Current Topics in Membranes and Transport*. 8:29-97.
- Garrahan, P. J., and I. M. Glynn. 1967a. The behaviour of the sodium pump in red cells in the absence of external potassium. *Journal of Physiology*. 192:159-174.
- Garrahan, P. J., and I. M. Glynn. 1967b. Factors affecting the relative magnitude of the sodium:potassium and sodium:sodium exchanges catalysed by the sodium pump. *Journal of Physiology*. 192:189-216.
- Garrahan, P. J., and I. M. Glynn. 1967c. The stoichiometry of the sodium pump. *Journal of Physiology*. 192:217-235.
- Glynn, I. M. 1985. The Na,K-transporting adenosine triphosphatase. In *The Enzymes of Biological Membranes*. 2nd ed. A. Martinosi, editor. Plenum Press, New York. 3:35-114.
- Glynn, I. M., and J. F. Hoffman. 1971. Nucleotide requirements for sodium-sodium exchange catalysed by the sodium pump in human red cells. *Journal of Physiology*. 218:239-256.
- Glynn, I. M., and S. J. D. Karlish. 1975. The sodium pump. *Annual Review of Physiology*. 37:13-55.
- Glynn, I. M., and S. J. D. Karlish. 1976. ATP hydrolysis associated with an uncoupled sodium flux through the sodium pump: evidence for allosteric effects of intracellular ATP and extracellular sodium. *Journal of Physiology*. 256:465-496.
- Glynn, I. M., and D. E. Richards. 1982. Occlusion of rubidium ions by the sodium-potassium pump: its implications for the mechanism of potassium transport. *Journal of Physiology*. 30:17-43.
- Hara, Y., and M. Nakao. 1981. Sodium ion discharge from pig kidney Na^+, K^+ -ATPase. Na^+ -dependency of the $\text{E}_1\text{P} \rightleftharpoons \text{E}_2\text{P}$ equilibrium in the absence of KCl. *Journal of Biochemistry*. 90:923-931.
- Hegyvary, C., and R. L. Post. 1971. Binding of adenosine triphosphate to sodium and potassium ion-stimulated adenosine triphosphatase. *Journal of Biological Chemistry*. 246:5234-5240.
- Hexum, T., F. E. Samson, and R. H. Himes. 1970. Kinetic studies of membrane ($\text{Na}^+ \text{K}^+ \text{Mg}^{2+}$)-ATPase. *Biochimica et Biophysica Acta*. 212:322-331.
- Hobbs, A. S., and P. B. Dunham. 1976. Evidence for two sodium sites on the external aspect of Na-K pump in human erythrocytes. *Nature*. 260:651-652.
- Hobbs, A. S., and P. B. Dunham. 1978. Interaction of external alkali metal ions with the Na-K pump of human erythrocytes. A comparison of their effects on activation of the pump and on the rate of ouabain binding. *Journal of General Physiology*. 72:381-402.
- Hoffman, J. F. 1962. The active transport of sodium by ghosts of human red blood cells. *Journal of General Physiology*. 45:837-859.
- Hoffman, J. F. 1978. Asymmetry and the mechanism of the red cell Na-K pump, determined by ouabain binding. In *Molecular Specialization and Symmetry in Membrane Function*. A. K. Solomon and M. Karnovsky, editors. Harvard University Press, Cambridge, MA. 191-211.
- Hoffman, J. F. 1980. The link between metabolism and active transport of sodium in human red cell ghosts. *Journal of Membrane Biology*. 57:143-161.

- Hoffman, J. F., B. G. Kennedy, and G. Lunn. 1981. Modulation of red cell Na/K pump rates. *In Erythrocyte Membranes 2. Clinical and Experimental Advances*. W. C. Kruckberg, J. W. Eaton, and G. J. Brewer, editors. Alan R. Liss, Inc., New York. 5–9.
- Kanazawa, T., M. Saeto, and Y. Tonomura. 1970. Formation and decomposition of a phosphorylated intermediate in the reaction of Na⁺-K⁺ dependent ATPase. *Journal of Biochemistry*. 67:693–711.
- Kaplan, J. H. 1982. Sodium pump-mediated ATP:ADP exchange. *Journal of General Physiology*. 80:915–937.
- Kaplan, J. H., and R. J. Hollis. 1980. External Na dependence of ouabain-sensitive ATP:ADP exchange initiated by photolysis of intracellular caged-ATP in human red cell ghosts. *Nature*. 288:587–589.
- Kaplan, J. H., and L. J. Kenney. 1982. ADP supports ouabain-sensitive K-K exchange in human red blood cells. *Annals of the New York Academy of Sciences*. 402:292–295.
- Karlish, S. J. D., D. W. Yates, and I. M. Glynn. 1978. Conformational transitions between Na⁺-bound and K⁺-bound forms of [Na⁺ + K⁺]-ATPase, studied with formycin nucleotides. *Biochimica et Biophysica Acta*. 525:252–264.
- Kennedy, B. G., and P. De Weer. 1976. Strophanthidin-sensitive sodium fluxes in metabolically poisoned frog skeletal muscle. *Journal of General Physiology*. 68:405–420.
- Kennedy, B. G., and P. De Weer. 1977. Relationship between Na:K and Na:Na exchange by the sodium pump of skeletal muscle. *Nature*. 268:165–167.
- Kennedy, B. G., G. Lunn, and J. F. Hoffman. 1980. Effect of changing ATP/ADP ratios on the operation of the Na:K pump of red blood cell ghosts. *Federation Proceedings*. 39:1978. (Abstr.)
- Kennedy, B. G., G. Lunn, and J. F. Hoffman. 1983. Effect of intracellular adenine nucleotides on sodium pump catalyzed Na:K and Na:Na exchanges. *Current Topics in Membranes and Transport*. 19:683–696.
- Keynes, R. D., and R. A. Steinhardt. 1968. The components of the sodium efflux in frog muscle. *Journal of Physiology*. 198:581–599.
- Levin, M. L., F. C. Rector, and D. W. Seldin. 1968. Effects of potassium and ouabain on sodium transport in human red cells. *American Journal of Physiology*. 214:1328–1332.
- Lienhard, G. E., and I. I. Secemski. 1973. P¹, P⁵-di(adenosine-5') pentaphosphate, a potent multisubstrate inhibitor of adenylate kinase. *Journal of Biological Chemistry*. 248:1121–1123.
- Lipmann, F. 1960. Attempts toward a formulation of biological use of energy in terms of chemical potentials. *In Molecular Biology*. D. Nachmansohn, editor. Academic Press, Inc., New York. 37.
- Lowry, O. H., and J. V. Passonneau. 1972. *A Flexible system of Enzymatic Analysis*. Academic Press, Inc., New York. 291 pp.
- Mercer, R. W., and P. B. Dunham. 1981. Membrane-bound ATP fuels the Na/K pump. *Journal of General Physiology*. 78:547–568.
- Mone, M. D., and J. H. Kaplan. 1982. ADP interacts with a low affinity site on the (Na+K)ATPase. *Biophysical Journal*. 37:178a. (Abstr.)
- Morrison, J. F. 1973. Arginine kinase and other invertebrate guanidino kinases. *In The Enzymes*. 3rd ed. Vol. VIIIa: Group Transfer. P. D. Boyer, editor. Academic Press, Inc., New York. 457–485.
- Mullins, L. J., and F. J. Brinley. 1967. Some factors influencing sodium extrusion by internally dialyzed squid axons. *Journal of General Physiology*. 50:2333–2355.
- Neufeld, A. H., and H. M. Levy. 1969. A second ouabain-sensitive and sodium-dependent

- adenosine triphosphatase in brain microsomes. *Journal of Biological Chemistry*. 244:6493–6497.
- Nørby, J. G., and J. Jensen. 1971. Binding of ATP to brain microsomal ATPase. Determination of the ATP-binding capacity and the dissociation constant of the enzyme-ATP complex as a function of K^+ concentration. *Biochimica et Biophysica Acta*. 223:104–116.
- Okonkwo, P. O., G. Longenecker, and A. Askari. 1975. Studies on the mechanism of inhibition of the red cell metabolism by cardiac glycosides. *Journal of Pharmacology and Experimental Therapeutics*. 163:407–416.
- Parker, J. C., and J. F. Hoffman. 1967. The role of membrane phosphoglycerate kinase in the control of glycolytic rate by active cation transport in human red blood cells. *Journal of General Physiology*. 50:893–916.
- Post, R. L., C. Hegyvary, and S. Kume. 1972. Activation by adenosine triphosphate in the phosphorylation kinetics of sodium and potassium ion transport adenosine triphosphate. *Journal of Biological Chemistry*. 247:6530–6540.
- Proverbio, F., and J. F. Hoffman. 1977. Membrane compartmentalized ATP and its preferential use by the Na,K-ATPase of human red cell ghosts. *Journal of General Physiology*. 69:605–632.
- Robinson, J. D. 1976a. Substrate sites of the $(Na^+ + K^+)$ -dependent ATPase. *Biochimica et Biophysica Acta*. 429:1006–1019.
- Robinson, J. D. 1976b. The $(Na^+ + K^+)$ -dependent ATPase mode of inhibition of ADP/ATP exchange activity by $MgCl_2$. *Biochimica et Biophysica Acta*. 440:711–722.
- Robinson, J. D., and M. S. Flashner. 1979. The $(Na^+ + K^+)$ -activated ATPase enzymatic and transport properties. *Biochimica et Biophysica Acta*. 549:145–176.
- Sachs, J. R. 1970. Sodium movements in the human red blood cell. *Journal of General Physiology*. 56:322–341.
- Sachs, J. R. 1974. Interaction of external K, Na, and cardioactive steroids with Na-K pump of the human red blood cell. *Journal of General Physiology*. 63:123–143.
- Sachs, J. R. 1977. Kinetics of the inhibition of the Na:K pump by external sodium. *Journal of Physiology*. 264:449–470.
- Sakamoto, J., and Y. Tonomura. 1980. Order of release of ADP and P_i from phosphoenzyme with bound ADP and Ca^{2+} -dependent ATPase from sarcoplasmic reticulum and of Na^+ , K^+ -dependent ATPase studied by ADP-inhibition patterns. *Journal of Biochemistry*. 87:1721–1727.
- Segel, G. B., S. A. Feig, B. E. Glader, A. Muller, P. Ducher, and D. G. Nathan. 1975. Energy metabolism in human erythrocytes: the role of phosphoglycerate kinase in cation transport. *Blood*. 46:271–278.
- Simons, T. J. B. 1974. Potassium:potassium exchange catalysed by the sodium pump in human red cells. *Journal of Physiology*. 237:123–155.
- Tatibana, M., M. Nakao, and H. Yoshikawa. 1958. Adenylate kinase in human erythrocytes. *Journal of Biochemistry*. 45:1037.
- Watts, D. 1973. Creatine kinase (adenosine 5'-triphosphate-creatine phosphotransferase). In *The Enzymes*. 3rd ed. Vol. VIIa: Group Transfer. P. D. Boyer, editor. Academic Press, Inc., New York. 383–455.