

# Electrical Characteristics of Tunicate Heart Cell Membranes and Nexuses

MAHLON E. KRIEBEL

From the Department of Zoology, University of Washington, Seattle, Washington 98105, and the Department of Anatomy, Albert Einstein College of Medicine, Yeshiva University, Bronx, New York 10461. Dr. Kriebel's present address is the Department of Anatomy, Albert Einstein College of Medicine, Yeshiva University, Bronx, New York 10461

**ABSTRACT** The tubular ascidian heart is composed of a single layer of cells joined together by apical (zonulae occludentes) and spot (maculae occludentes) nexuses. Intercalated discs or desmosomes were not observed in this tissue. Rectangular pulses of current were applied across the opened and flattened myocardium. Assuming that all the transepithelial current flowed through a uniform gap between cells, the resistivity in the gap must be very high compared to that in bulk solution. It is likely, therefore, that the gap width is of the order of an ionic radius or smaller. Assuming that all the transepithelial current flowed through the cells and that the inner and outer membranes had the same resistivity, the membrane resistivity was about 210 ohms  $\text{cm}^2$  and the membrane capacitance was about 1.6  $\mu\text{F}$  per  $\text{cm}^2$ . The myocardial cells were found to be in electrical continuity with each other through the nexuses since current could be passed through a strip of myocardium in a sucrose gap. Assuming that the longitudinal resistance of the cytoplasm was negligible, the cell-to-cell resistivity of the nexuses was 0.2 ohm  $\text{cm}^2$ . It is concluded that the nexuses provide a low resistance pathway between cells and a transepithelial barrier.

## INTRODUCTION

The spread of excitation through the tubular ascidian heart is probably mediated by local current flow between unexcited cells serving as a current sink and excited cells serving as a current source (Kriebel, 1967 *a* and *b*, 1968). Impulse spread between cells by local current flow requires a low resistance pathway so that the adjoining cells are in electrical continuity and are not isolated by a wide, continuous layer of extracellular fluid (cf. Woodbury, 1962). Nexuses (tight junctions) probably represent the morphological structure between vertebrate heart cells that has the property of a low cell-to-cell resistance (Dewey and Barr, 1964; Barr, Dewey, and Berger, 1965).

Electron micrographs and phase contrast photographs presented here show that the heart walls of *Ciona* and *Chelyosoma* are one cell layer thick. The fusiform musculoendothelial cells are oriented about  $70^\circ$  to the heart axis. The lateral cell surfaces of neighboring cells are joined by apical (zonulae occludentes) and spot (maculae occludentes) nexuses (cf. Farquhar and Palade, 1963). Neither desmosomes nor intercalated discs are in evidence.

The width of nexuses appears to be uniform in all animal groups and nexuses are thought to represent a fusion of the outer layers of the unit membranes of adjoining cells (Robertson, 1961; Dewey and Barr, 1964; Elbers,

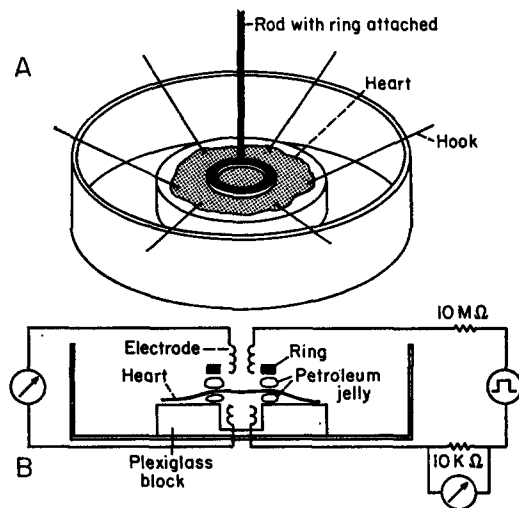

FIGURE 1 A. Diagrammatic representation of the chamber for measuring the transverse heart resistance. B. Cross-section through the above chamber.

1964). The possibility did exist, however, that there were thin gaps or tunnels filled with extracellular fluid in the nexus regions not detectable with the techniques currently employed in electron microscopy. The transepithelial heart resistance of ascidians has been determined and calculations are presented which show that if there is a uniform gap between cells it is so narrow that the conductivity for transepithelial ion flow is greatly reduced.

The longitudinal resistance of the heart was determined by placing it in a sucrose gap. The specific cell-to-cell nexus resistance was estimated by assuming that the longitudinal heart resistance was mainly due to rows of nexuses. An abstract has been published (Kriebel, 1966).

## METHODS

### A. Determination of the Cellular Structure

The tubular hearts of adult ascidians (subphylum Tunicata, phylum Chordata) *Ciona intestinalis* (California) and *Chelyosoma productum* (Washington) were cut in half and each half was opened along the heart-pericardial junction to form a flat sheet about 25 mm  $\times$  4 mm.

Hearts were placed under a coverslip supported by two ridges of petroleum jelly and were perfused with cold seawater. Hearts were neither stretched nor compressed and since they were beating they adjusted to normal *in situ* dimensions. Photographs were taken with a  $\times 100$  oil immersion phase contrast objective in order to determine the average cell area, the total length of apical cell boundaries per unit area of tissue, and the cellular orientation.

For electron microscopy, hearts were fixed for 1 hr in 4%  $\text{OsO}_4$ , buffered at pH 7.4 with 0.1 M s-collidine at  $0-4^\circ\text{C}$  (Bennett and Luft, 1959), and embedded in Epon

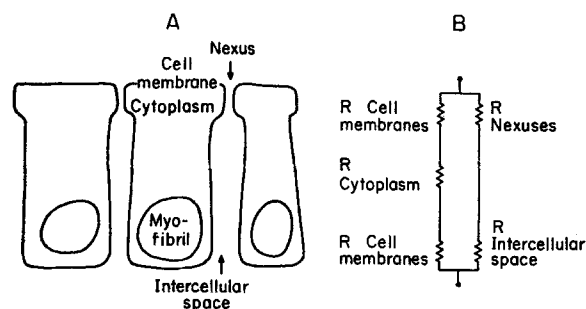

FIGURE 2 A. Diagrammatic cross-section through the heart as seen in Fig. 1 B. B. Electrical circuit of the resistances across the sheet of heart tissue as seen in Fig. 2 A.

according to the method of Luft (1961). Sections were cut at 600–800 Å on a LKB Ultratome. Micrographs were made with an RCA 3G electron microscope.

#### B. Determination of the Transverse Electrical Resistance of a Flat Sheet of Heart Tissue (Sandwich Preparation)

Pieces of opened heart were transferred to a small bath and gently positioned over a  $1 \text{ mm}^2$  chamber, ringed with petroleum jelly, in a block of Plexiglass (Fig. 1 A and B). The tissue was not stretched. A small celluloid ring, covered with petroleum jelly, was lowered onto the heart sealing off the  $1 \text{ mm}^2$  chamber. A hydraulic system was connected to the small chamber so that a constant volume could be maintained during sealing. This method of sealing was adequate since a piece of cellophane, "sandwiched" between the two chambers, insulated them electrically.

Square pulses of alternating polarity (1/sec, 20 msec duration) were passed between two electrodes (one in each chamber) with Tektronix waveform and pulse generators. The voltage drop across the sheet of heart tissue (Fig. 2) was measured between two additional electrodes connected to either a Grass Model 7 polygraph equipped with a Grass Model 7P5A preamplifier or a Tektronix 565 oscilloscope. The current passing through the heart was determined by recording the voltage drop across a 10 kohm resistor in series with the heart. A  $10 \text{ M}\Omega$  resistor was placed in series with the polarizing electrodes to approximate a constant current. The time constant of the apparatus was found to be  $2 \mu\text{sec}$  when the cellophane (see previous paragraph) was perforated making a 25 kohm channel.

*C. Determination of the Specific Resistivity of the Heart (Long Axis) with a Sucrose-Gap Technique*

A 950 mM solution of sucrose was found to be isosmotic with seawater by freezing point determinations. The sucrose was deionized in a mixed bed ion exchange resin (Amberlite MB-1; see Julian, Moore, and Goldman, 1962). There was less than

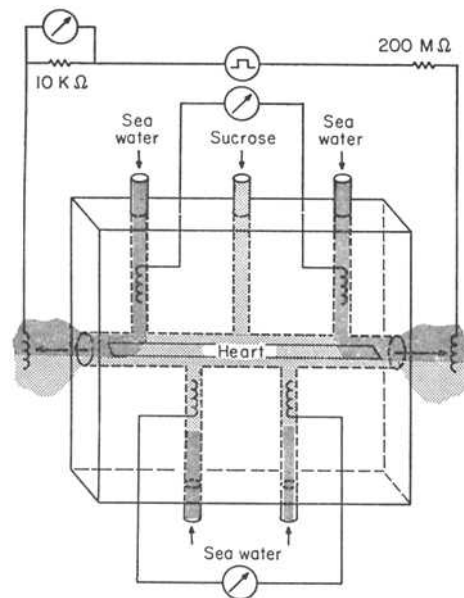

FIGURE 3. Diagrammatic representation of the sucrose gap chamber. The upper seawater inlets produced a 10 mm long gap and the lower inlets produced a 5 mm long gap.

0.25% hydrolysis of the sucrose by the resin as determined with freezing point analyses. The specific resistivity of the sucrose solution was determined with a Simpson Model (Simpson Electric Co., Chicago, Ill.) 311 vacuum tube volt-ohmmeter to be about  $2 \text{ M}\Omega\text{-cm}$ .

Small holes (0.020 inch diameter) were drilled through a block of Plexiglass to form the sucrose-gap chamber shown in Fig. 3. Stainless steel pins were positioned through the Plexiglass block into the middle of the gap chamber opposite the seawater inlets (not shown in Fig. 3). Two sets of pins were set exactly 5 mm and 10 mm apart so that a 10 mm or a 5 mm long sucrose gap was established by perfusing seawater through the respective inlets. One end of an opened heart was tied to a fine nylon filament ( $50 \mu$  diameter) and pulled into the sucrose-gap chamber which was initially filled with seawater. The heart was threaded on the seawater inlet side of the stainless steel pins. After positioning, the beating hearts adjusted to a normal length. The flow rates (about 1 cc/min) were adjusted by raising or lowering reservoirs so that the sucrose-seawater interfaces formed sharp boundaries across the heart. Schematized in Fig. 4 A.

Pulses of  $10^{-8}$  amp, of 80 msec duration, and alternating polarity were passed through the 10 mm or 5 mm long gap between Ag-AgCl electrodes positioned at each

end of the gap. The current was determined from the voltage drop across a 10 k $\Omega$  resistor in series with the preparation. A 200 M $\Omega$  resistor was placed in series to approximate a constant current during the development of the sucrose gap. The voltage drop across the gap was differentially recorded with a Grass Model 7P5A preamplifier with the input impedance increased to 100 M $\Omega$ , and with a Grass Model 7 polygraph. The preamplifier was calibrated against known resistances. With constant current, the recording method was nearly linear in the required range of 1 to 20 M $\Omega$ .

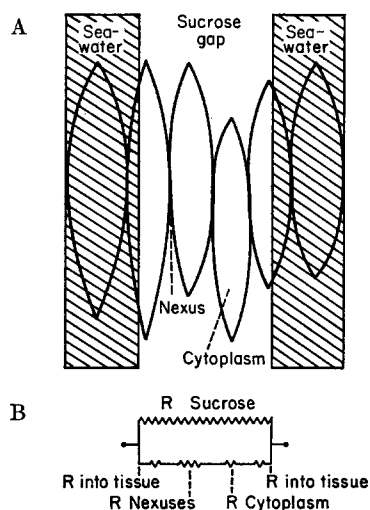

FIGURE 4 A. Diagrammatic flat view of the heart cells in the sucrose gap. B. Electrical circuit of the sucrose gap.

## RESULTS AND DISCUSSION

### A. Cellular Structure of the Myocardium

Phase contrast photographs show that the myocardium of both *Ciona* and *Chelyosoma* is composed of one musculoendothelial cell type. The cells are 90  $\mu$  long, 2  $\mu$  wide at the base (lumen surface), 5  $\mu$  wide at the apex, and 10  $\mu$  high in the central region (Figs. 5 A and 6 B). The myofibrils lie near the luminal surface and each cell contains one nucleus in the central region.

In both species, the heart thickness as determined by focusing on the apical and luminal surfaces of living tissue was 10  $\mu$ . The cell shape can be geometrically described with two cones of base diameters of 7  $\mu$  and altitudes of 50  $\mu$  (Table I).

Electron micrographs show that the heart wall is essentially one cell layer thick (Fig. 7 A) and that nexuses (zonulae occludentes) are present between all cells towards the apical surface (Fig. 7 B). This indicates that all cells must be circumjacentely joined to their neighbors by nexuses. In order to give the apical nexus dimensions, the *height* is defined as in the transepithelial direction (Fig. 7), the *length* is the cell border length per unit area of tissue at the level

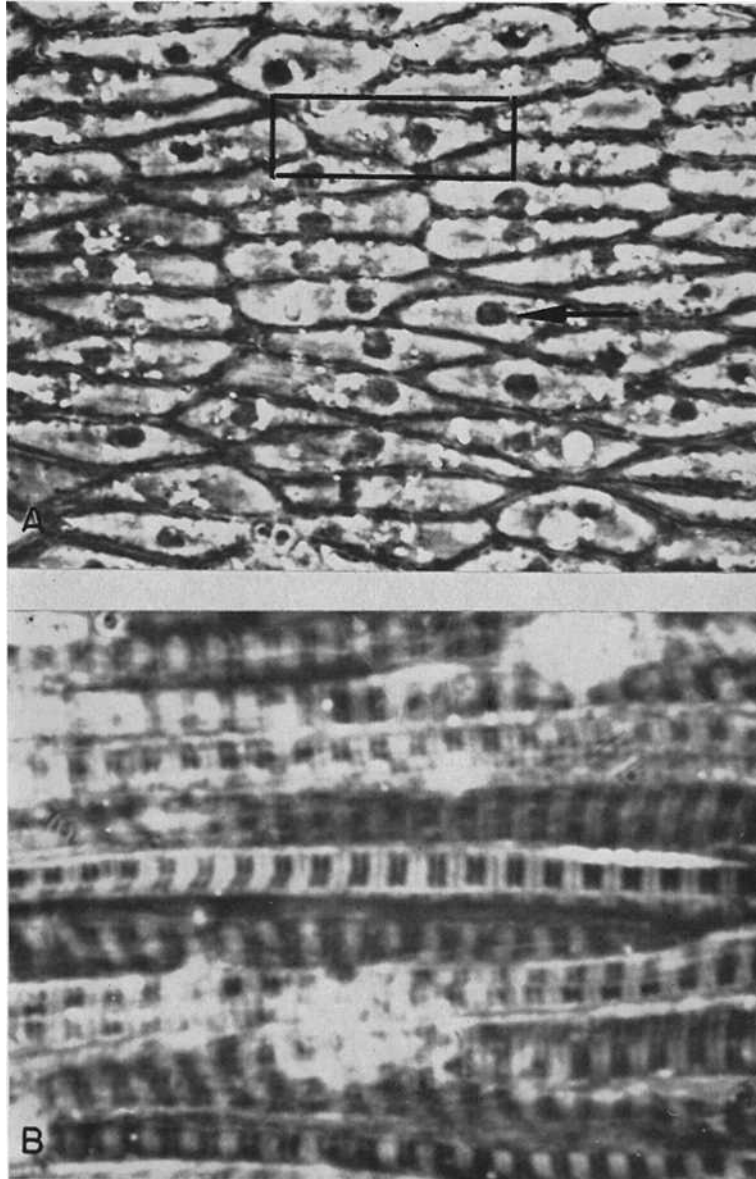

FIGURE 5. Phase contrast photographs of a piece of living *Chelyosoma* heart. A. The microscope was focused towards the apical surface showing the cell boundaries at the level of the apex nexuses in Fig. 6. One cell is enclosed within the box. A nucleus is indicated with the arrow.  $\times 1000$ . B. Same tissue as above but the microscope was focused on the mvofibrils towards the luminal surface.  $\times 2000$ .

of the apical nexus (Fig. 5 A), and the *width* or *gap* is the distance between cells.

There are randomly spaced nexus spots (maculae ocludentes) below the apex (Fig. 7 D). The intercellular space is continuous with the lumen of the heart since there are intercellular spaces near the lumen between most cells

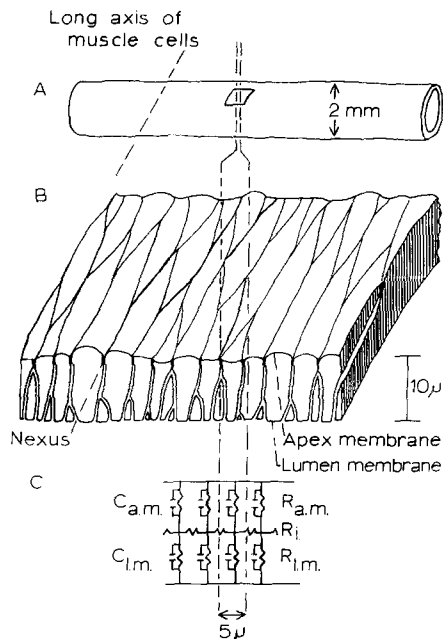

FIGURE 6. Equivalent circuit for the long axis of a *Chelyosoma* heart. A. Diagrammatic representation of a 10 mm long segment of heart. B. Semischematic diagram of the cells in the region of the box in (A). Apical nexuses are represented, myofibrils and spot nexuses are not shown. C. Equivalent circuit for each 5 μ length of heart. Values are calculated from Table I.

$R_{a.m.}$ , resistance of the apex membrane =  $7.7 \times 10^5$  ohms.  $C_{a.m.}$ , capacitance of the apex membrane =  $5.4 \times 10^{-10}$  farad.  $R_{i.}$ , internal resistance of the tissue =  $2.3 \times 10^3$  ohms.  $R_{l.m.}$ , resistance of the lumen membrane =  $1.5 \times 10^5$  ohms.  $C_{l.m.}$ , capacitance of the lumen membrane =  $2.5 \times 10^{-9}$  farad.

and some of these are continuous to the apical nexus (Fig. 7 A and C). The heights of the apical and spot nexuses were found to be about  $0.5 \mu$ . The total nexus height between cells was found to be  $1.5 \mu$  which is one-seventh of the lateral cell border.

#### B. Transepithelial Resistance of the Flat Sheet of Heart Tissue

Fig. 8 A shows the increase in resistance as a piece of opened heart was sealed between the two chambers as diagrammed in Fig. 1. Fig. 8 B shows the time course of the voltage change due to an applied current pulse across the heart.

The average specific transepithelial tissue resistance of nine *Ciona* hearts was 230 (range  $\pm 30$ ) ohms  $cm^2$ , the average time constant was 0.32 (range  $\pm 0.02$ ) msec, and the average capacitance was 1.34 (range  $\pm 0.15$ )  $\mu F$  per  $cm^2$ . These parameters from seven *Chelyosoma* hearts were 280 (range  $\pm 70$ ) ohms  $cm^2$ , 0.40 (range  $\pm 0.1$ ) msec, and 1.4 (range  $\pm 0.4$ )  $\mu F$  per  $cm^2$ .

TABLE I  
DIMENSIONS AND ELECTRICAL PARAMETERS  
OF THE MYOCARDIUM AND CELLS

	<i>Chelyosoma</i>	<i>Ciona</i>
Apex (or lumen) surface area/cell, $\mu^2$	$1.1 \times 10^2$	$1.0 \times 10^2$
Cell volume, $\mu^3$	$1.1 \times 10^3$	$1.0 \times 10^3$
Cell length, $\mu$	80-120	50-110
Maximal cell (also heart) thickness, $\mu$	10	10
Maximal cell width, $\mu$	5-6	4-5
Average diameter, $\mu$	7	7
Total cell surface, $\mu^2$	$1.1 \times 10^3$	$1.0 \times 10^3$
Nonspecialized membrane, $\mu^2$		$8.0 \times 10^2$
Nexus, $\mu^2$		$2.0 \times 10^2$
Transepithelial height of a single nexus, $\mu$		0.5
Total transepithelial nexus height (apical and spot nexuses), $\mu$		1.5
Specific transepithelial tissue resistance, ohms $cm^2$	$2.8 \times 10^2$	$2.3 \times 10^2$
Transepithelial resistance/cell, ohms	$2.8 \times 10^3$	$2.3 \times 10^3$
Specific membrane resistance, ohms $cm^2$	$2.3 \times 10^2$	$1.9 \times 10^2$
Transepithelial capacitance, $\mu F$ per $cm^2$	1.4	1.3
Transepithelial capacitance/cell, $\mu F$	$1.4 \times 10^{-6}$	$1.3 \times 10^{-6}$
Membrane capacitance, $\mu F$ per $cm^2$	1.7	1.6
Capacitance/cell, $\mu F$	$1.7 \times 10^{-5}$	$1.6 \times 10^{-5}$
Longitudinal heart resistance, $M\Omega \times mm$ length/ $mm$ width	2.8	1.6
Specific longitudinal resistivity of heart, ohms-cm	$2.8 \times 10^3$	$1.6 \times 10^3$
Specific nexus resistance,* ohms $cm^2$	0.3	0.2
Membrane resistance of one cell in tissue (calculated)		
Nonspecialized membrane, ohms		$2.7 \times 10^7$
Nexus, ohms		$1.0 \times 10^5$
Membrane resistance of one isolated cell, no nexus, ohms (calculated)		$2.3 \times 10^7$
Input resistance of one cell in tissue (measured), $\ddagger$ ohms	$3.9 \times 10^6$	

\* It is assumed that nexuses in *Chelyosoma* are about the same height as in *Ciona*.

$\ddagger$  Kriebel (1968).

The equivalent circuit of the transepithelial resistance of the heart is represented in Fig. 2 B and expressed by the equation:

$$\frac{1}{R_{\text{tissue}}} = \frac{1}{R_{\text{cytoplasm}} + 2R_{\text{cell membrane}}} + \frac{1}{R_{\text{nexus}} + R_{\text{intercellular space (gap)}}} \quad (1)$$

The total length of cell boundaries was over  $4 \times 10^5 \mu$  per  $mm^2$  of tissue. Assuming that the unit membrane is 75 A thick, the intercellular space below



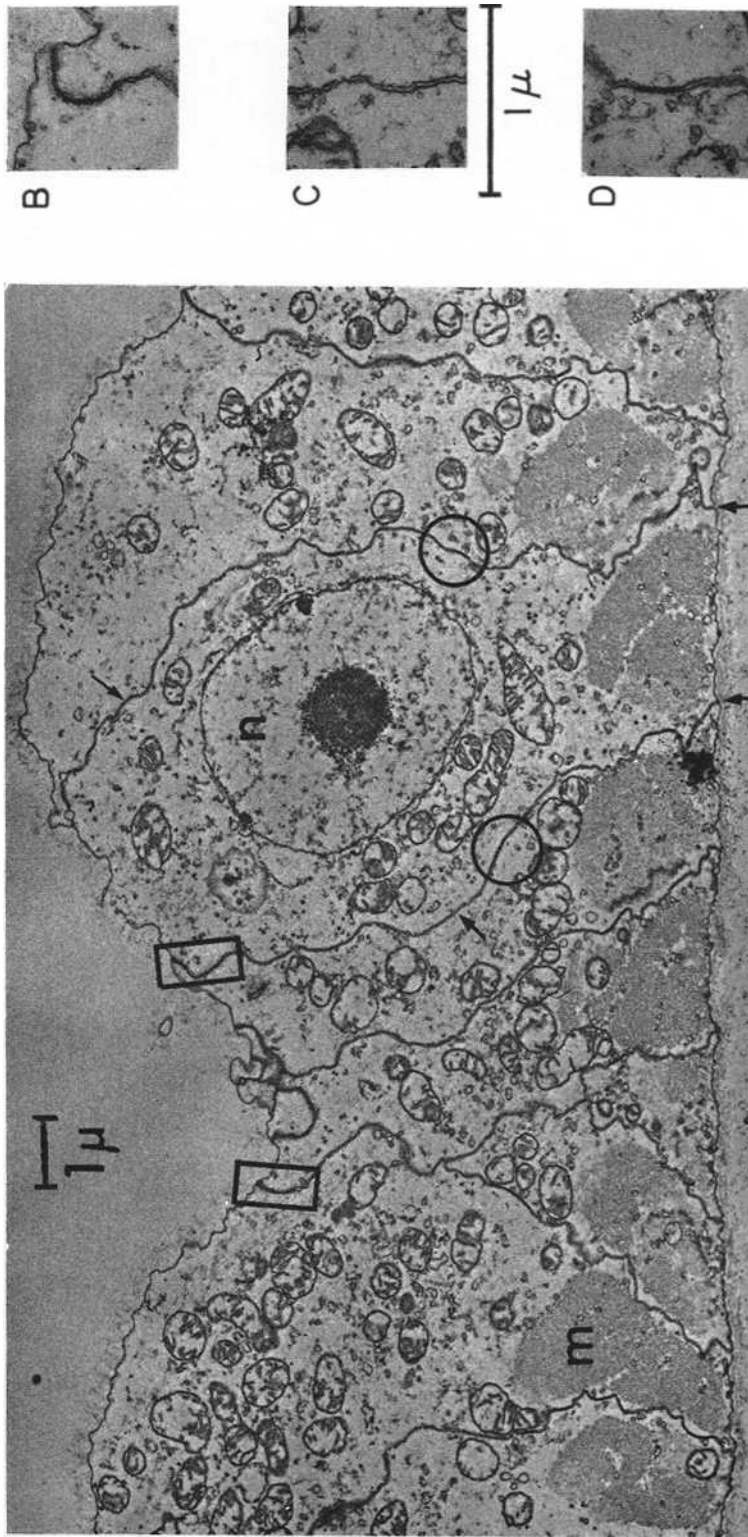

FIGURE 7. Electron micrographs of *Ciona* heart tissue. A. Cross-section through heart wall ( $10\ \mu$  thick) shows several cells.  $\times 9,100$ . There is one myofibril (*m*) and one nucleus (*n*) in each cell. Nexuses are indicated in regions where electron-dense lines representing membranes appear less than the usual  $200\ \text{A}$  distance apart. In many tissues only the inner cytoplasmic leaflet of the unit membrane stains with  $\text{OsO}_4$  (Dewey and Barr, 1964) so that a narrow gap still appears between adjacent cells in nexus regions. When the widths of the outer leaflets of the apposing unit membranes are subtracted from the  $200\ \text{A}$  space between cells (at arrows), the intercellular space is reduced to  $150\ \text{A}$  and the nexus gap of  $50\ \text{A}$  is obliterated. Note the presence of an apical nexuse between all cells (enclosed within boxes). Two spot nexuses are encircled. Note the absence of nexuses near the luminal surface (arrows). B. Apical nexuse.  $\times 24,000$ . C. Normal gap between adjacent cells.  $\times 24,000$ . D. Spot nexuse.  $\times 24,000$ .

the apical nexuses is about 150 Å wide (distance between the electron-dense cytoplasmic edges of adjacent membranes is at least 300 Å). The value of the term  $R_{\text{intercellular space}}$  would be less than 300 ohms (intercellular space filled with seawater, specific resistivity, 23 ohms-cm) which is small when compared to that of the term  $R_{\text{tissue}}$  so it may be omitted from expression (1).

Assuming that nexuses are filled with seawater, the resistivity equation can be used to calculate the gap width. In order to calculate the maximal hypothetical nexus gap with the resistivity equation (2),  $R_{\text{nexus}}$  was given a minimal value by arbitrarily ascribing an infinitely large value to  $R_{\text{cell membrane}}$ .

$$R_{\text{nexus (gap)}} = \rho \times \frac{\text{height of apex nexus}}{\text{maximal gap between cells} \times \text{cell border length}} \quad (2)$$

The resistivity term ( $\rho$ ) for seawater is about 23 ohms-cm. The resistance of 16 preparations (1 mm<sup>2</sup> pieces of tissue of both *Ciona* and *Chelyosoma*) averaged  $2.5 \times 10^3$  ohms so the term  $R_{\text{nexus}}$  equals 250 ohms cm<sup>2</sup>. The height (trans-epithelial dimension) of the apical nexuses was  $5 \times 10^{-5}$  cm as determined from electron micrographs (Fig. 7 B). The minimal cell border length which is equal to the nexus length as determined by phase contrast microscopy (Fig. 5 A) was  $4 \times 10^3$  cm per cm<sup>2</sup>.

On substitution, the maximal uniform gap in the nexus equals 0.12 Å. This demonstrates that if a uniform gap in the apical nexus is present, the resistivity for transepithelial ion flow cannot be that of the bulk solution since the gap would be less than the diameter of a hydrated sodium ion (which is about 7 Å; Mullins, 1961). Similar conclusions can be drawn from transepithelial resistances of other tissues (cf. Waltman, 1966).

However, it is possible that there are tunnels within the nexuses which are large enough to permit ions to pass across the heart wall between cells. Assuming that all current flowed through hypothetical tunnels with a diameter of 8 Å, there could be one tunnel for each 400 Å of cell border. Expressed another way, this would be one tunnel for every  $2 \times 10^6$  Å<sup>2</sup> of apical nexus surface between cells. The resistance through a 0.5 μ long tunnel would be  $5.5 \times 10^{13}$  ohms. The resistance between cells on each side of the hypothetical tunnel through the nexus (specific resistivity determined in the next section) would be  $5 \times 10^8$  ohms. Consequently, such a small number of hypothetical tunnels of high resistance would not short-circuit impulse current between cells by an appreciable amount.

If it is assumed that no current passed between cells, the measured transverse heart resistance gives a lower limit for the apical and luminal cell membranes. Since the calculated resistance of the intercellular space is low, the lateral cell surface can be considered electrically as part of the luminal membrane; therefore, there is about five times more cell membrane in electrical contact with the luminal medium than with the apical medium. The two

series-coupled membranes may have the same time constant since the voltage-time curve in Fig. 8 B approximates a single exponential curve.

Assuming that the specific membrane resistance of the apical and luminal surfaces is the same, the specific membrane resistance of *Ciona* and *Chelyosoma*

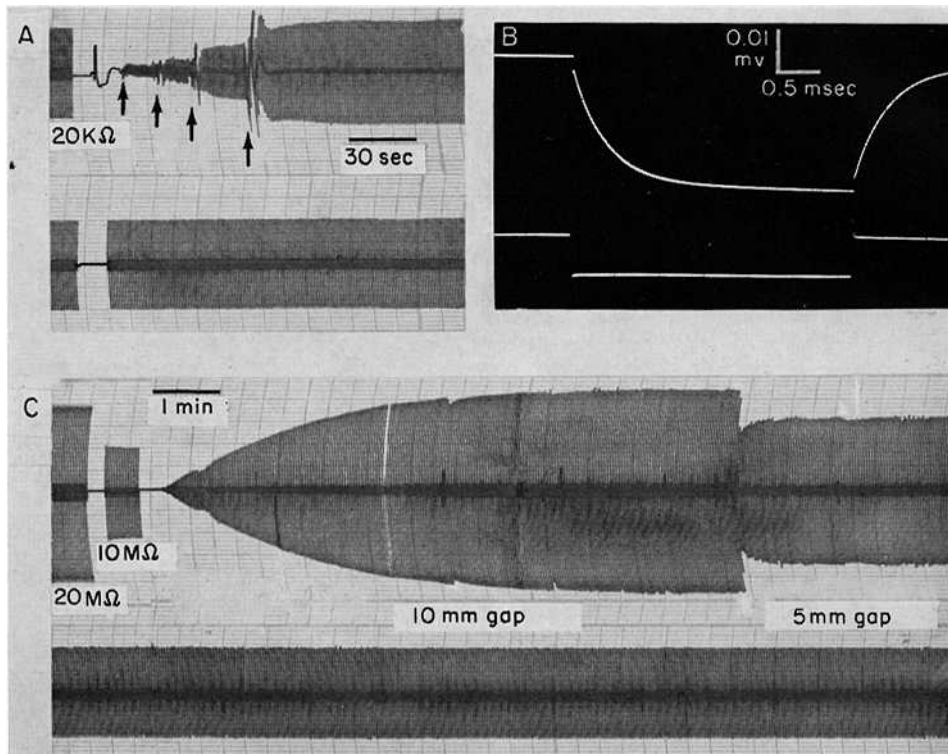

FIGURE 8 A. Continuous oscillograph record of the voltage developed across a  $1 \text{ mm}^2$  sheet of *Ciona* heart. Top trace, at the start of the record, the voltage was recorded across a calibrating  $20 \text{ kohm}$  resistor. The heart was progressively sealed between the electrodes by pressing small hooks (indicated on record by arrows) on top of the ring shown in Fig. 1. Heart resistance was  $24 \text{ kohms}$ . Bottom trace, voltage drop across a  $10 \text{ kohm}$  resistor in series with the heart. Polarizing pulses are alternating in polarity. Current,  $2 \times 10^{-8}$  amp. B. Oscilloscope record of the time course of the voltage drop across a  $1 \text{ mm}^2$  sheet of *Chelyosoma* heart. Top trace, voltage drop across heart tissue. Resistance,  $30 \text{ kohms}$ , time constant,  $0.40 \text{ msec}$ , and capacitance,  $1.3 \times 10^{-8}$  farad. Bottom trace, voltage drop across a  $10 \text{ kohm}$  resistor in series with the tissue. Current,  $10^{-9}$  amp. C. Continuous oscillograph record of the voltage developed across a heart in the  $10 \text{ mm}$  and  $5 \text{ mm}$  long sucrose gap. Top trace, at the start of the record the voltage drop was recorded across calibrating  $20 \text{ M}\Omega$  and  $10 \text{ M}\Omega$  resistors. Sucrose was first perfused through the  $10 \text{ mm}$  gap, then the gap was reduced to  $5 \text{ mm}$ . The difference in voltage between the  $10$  and  $5 \text{ mm}$  gaps represents the voltage drop through  $5 \text{ mm}$  of heart tissue (see text). Bottom trace, voltage drop across a  $10 \text{ kohm}$  resistor in series with the gap. Current pulses are alternating in polarity. Current,  $10^{-8}$  amp.

heart cells was about  $1.9 \times 10^2$  ohms  $\text{cm}^2$  and  $2.3 \times 10^2$  ohms  $\text{cm}^2$ , respectively (Table I). The membrane capacitance of *Ciona* and *Chelyosoma* heart cell membranes was about 1.6 and 1.7  $\mu\text{F}$  per  $\text{cm}^2$ , respectively. These values are less but of the same order of magnitude as those of vertebrate heart cell membranes (Weidmann, 1952; Woodbury and Crill, 1961; Woodbury and Gordon, 1965).

In conclusion, the nexus regions between cells do not contain an extracellular gap wide enough to permit ion movement. Transepithelial tunnels large enough to permit ions to flow through them may exist, but if present tunnels would be very rare and have such a high resistance relative to the cell-to-cell resistance (see next section) that they would have little effect on impulse spread through nexuses by local current flow. Assuming no tunnels, the transepithelial heart resistance is composed of the luminal (which includes the lateral cell surface) and apical cell membranes and cytoplasm in series.

### C. Cell-to-Cell Resistivity of the Nexuses

Hearts stopped beating within 30 sec after the start of sucrose perfusion and within several minutes the voltage that developed from applied current pulses across the sucrose gap reached a plateau indicating that all the extracellular ions in the gap (seawater) had been replaced by sucrose (Fig. 8 C). Since current could pass through the heart in the sucrose gap, the myocardial cells must be in electrical continuity through the nexuses; i.e., the cells were not isolated from each other by a layer of sucrose. Hearts were left in the gap for up to 2 hr with little increase in resistance (maximum 10%). This indicates that few ions were leached from the heart while the sucrose gap was being maintained. When the sucrose was replaced with seawater, the hearts began to beat within a few minutes.

The interelectrode resistance was less than  $3 \times 10^3$  ohms when the 10 mm long gap was filled with seawater. Since this value is extremely small compared to the resistance of the gap (heart present) when filled with sucrose, the electrode resistances may be neglected. Since all the cells are parallel and oriented  $70^\circ$  to the long axis of the heart (Fig. 6 B), the equivalent circuit of the sucrose gap can be represented as in Fig. 4 B and expressed by:

$$\frac{1}{R_{\text{total}}} = \frac{1}{R_{\text{sucrose}}} + \frac{1}{R_{\text{cytoplasm}} + \frac{R_{\text{nexuses}}}{(\text{cell-to-cell})} + 2R_{\text{into tissue}}} \quad (3)$$

Since the  $R_{\text{sucrose}}$  term in a 10 mm long gap (minus the heart) was over 400  $\text{M}\Omega$  and the  $R_{\text{total}}$  term with the heart was less than 20  $\text{M}\Omega$ , the short-circuiting term  $R_{\text{sucrose}}$  is less than 5% of the  $R_{\text{total}}$  term. Therefore, the omission of  $R_{\text{sucrose}}$  from the above expression (3) introduces little error in the determination of the longitudinal heart resistance.

The longitudinal resistance of a 5 mm long piece of heart was determined by subtracting the total resistance of the 5 mm long gap from that of the 10 mm long gap (Fig. 8 C) which eliminated the term  $2R_{\text{into tissue}}$  from expression (3). The average longitudinal resistance of six 5 mm long strips of *Ciona* hearts (middle regions of arms of the V-shaped hearts) and six 5 mm long strips of *Chelyosoma* hearts was 8.3 (range  $\pm 2.1$ ) and 14.1 (range  $\pm 3.0$ ) M $\Omega$  divided by the width in millimeters, respectively. There was a maximum of 20% variation in each preparation in from three to six successive measurements. Several hearts were pulled out of the chamber and rethreaded. In these cases the measurements were in agreement within 30%. There was no rectification in the current range of  $1 \times 10^{-9}$  to  $1 \times 10^{-8}$  amp. All nexus resistance calculations were made with currents of  $10^{-9}$  amp and the total voltage developed across the electrodes was about 20 mv. The voltage drop across the tissue in the sucrose gap was about 14 mv which is only about 14  $\mu$ v (or 140  $\mu$ v for  $10^{-8}$  amp) across each cell. The voltage drop across each  $R_{\text{into tissue}}$  term was about 3 mv ( $10^{-9}$  amp) in which case no rectification would be expected. At  $10^{-8}$  amp the voltage change at  $R_{\text{into tissue}}$  was 30 mv. This voltage did not stimulate the heart to contract indicating that the threshold for excitation of the heart near the seawater-sucrose interface had probably increased. This may explain the absence of rectification at  $10^{-8}$  amp.

The cytoplasmic resistance of a strip of heart tissue (10  $\mu$  thick by 5 mm long), assuming 2 times the specific resistivity of seawater (23 ohms-cm), would be  $2.3 \times 10^6$  ohms divided by the width of the heart in millimeters. This value is still only 3% of the measured longitudinal heart resistance suggesting that the longitudinal resistance of the tissue resulted primarily from the nexuses.

The specific nexus resistance (cell-to-cell) can be calculated from the longitudinal heart resistance, from the number of rows of nexuses in the 5 mm long piece of heart, and from the cell-to-cell contact area of each nexus (width of heart times height of nexus). The myocardial cells are about 5  $\mu$  wide. There are about 1000 rows of nexuses in the 5 mm long gap with the cells oriented about  $70^\circ$  to the long axis of the heart. The nexus area for each row of cells in the gap is  $1.5 \times 10^{-6}$  cm<sup>2</sup> per mm width of heart. The specific cell-to-cell nexus resistance in *Chelyosoma* and *Ciona* is 0.3 (range  $\pm 0.1$ ) ohm cm<sup>2</sup> and 0.2 (range  $\pm 0.1$ ) ohm cm<sup>2</sup>, respectively (six preparations for each species, Table I).

An equivalent circuit of the heart can be constructed from the membrane resistances and from the longitudinal heart resistance (Fig. 6 C). Since the heart wall is only 10  $\mu$  thick and the diameter may be up to  $2 \times 10^3 \mu$ , and since it has been shown that an impulse cannot pass through the raphe, the tubular heart can be considered electrically as a sheet of tissue (Kriebel, 1967 b).

The specific cell-to-cell nexus resistance of tunicate hearts is in good agreement with the low resistance pathway between cells of 1 ohm cm<sup>2</sup> calculated from the space constant of the rat atrium (Woodbury and Crill, 1961) and with the upper limit of 3 ohms cm<sup>2</sup> for the potassium flux resistance between sheep trabecular fibers (Weidmann, 1966).

This work represents part of a dissertation submitted to the University of Washington, Seattle, Washington, in partial fulfillment of the requirements for the Ph.D. degree. It was supported in part by training grants 1 T1 GM 1194, 5 T1 GM 1194, and NIH 5 T1 MH 6418 11.

I wish to thank Dr. R. Cloney for the electron microscopy and Drs. M. V. L. Bennett and E. Florey for suggestions while preparing the manuscript.

*Received for publication 12 October 1967.*

#### REFERENCES

- BARR, L., M. M. DEWEY, and W. BERGER. 1965. Propagation of action potentials and the structure of the nexus in cardiac muscle. *J. Gen. Physiol.* **48**:797.
- BENNETT, H. S., and J. LUFT. 1959. S-collidine as a basis for buffering fixatives. *J. Biophys. Biochem. Cytol.* **6**:113.
- DEWEY, M. M., and L. BARR. 1964. A study of the structure and distribution of the nexus. *J. Cell Biol.* **23**:553.
- ELBERS, P. F. 1964. The cell membrane: Image and interpretation. In *Surface Phenomena in Chemistry and Biology*. J. F. Danielli, K. Pankhurst, and A. C. Riddiford, editors. Academic Press Inc., New York. **2**:443.
- FARQUHAR, M., and G. PALADE. 1963. Junctional complexes in various epithelia. *J. Cell Biol.* **17**:375.
- JULIAN, F. J., J. W. MOORE, and D. E. GOLDMAN. 1962. Membrane potentials of the lobster giant axon obtained by use of the sucrose-gap technique. *J. Gen. Physiol.* **45**:1195.
- KRIEBEL, M. E. 1966. The role of cell nexuses in the spread of excitation in the tunicate myocardium. *Am. Zoologist.* **6**:147.
- KRIEBEL, M. E. 1967 *a*. Physiological Studies on the Tunicate Heart. Ph.D. Thesis. University of Washington. Seattle, Washington.
- KRIEBEL, M. E. 1967 *b*. Conduction velocity and intracellular action potentials of the tunicate heart. *J. Gen. Physiol.* **50**:2097.
- KRIEBEL, M. E. 1968. Electrical coupling between tunicate heart cells. *Life Sci.* **7**:181.
- LUFT, J. H. 1961. Improvements in epoxy resin embedding methods. *J. Biophys. and Biochem. Cytol.* **9**:409.
- MULLINS, L. J. 1961. The macromolecular properties of excitable membranes. *Ann. N. Y. Acad. Sci.* **94**:390.
- ROBERTSON, J. D. 1961. Ultrastructure of excitable membranes and the crayfish median-giant synapse. *Ann. N. Y. Acad. Sci.* **94**:339.
- WALTMAN, B. 1966. Electrical properties and fine structure of the ampullary canals of Lorenzini. *Acta Physiol. Scand.* **66** (Suppl. 264).
- WEIDMANN, S. 1952. The electrical constants of Purkinje fibres. *J. Physiol. (London)*. **118**:348.
- WEIDMANN, S. 1966. The diffusion of radiopotassium across intercalated disks of mammalian cardiac muscle. *J. Physiol. (London)*. **187**:323.
- WOODBURY, J. W. 1962. Section 2: Circulation. Cellular electrophysiology of the heart. In *Handbook of Physiology*. W. F. Hamilton and P. Dow, editors. Waverly Press, Inc. Baltimore, Md. **1**:237.
- WOODBURY, J. W., and W. E. CRILL. 1961. On the problem of impulse conduction in the atrium. In *Nervous Inhibition*. E. Florey, editor. Pergamon Press, Inc., New York. 124.
- WOODBURY, J. W., and A. M. GORDON. 1965. The electrical equivalent circuit of heart muscle. *J. Cellular Comp. Physiol.* **66**: (Suppl. 2): 35.