

# Effect of External and Internal pH Changes on K and Cl Conductances in the Muscle Fiber Membrane of a Giant Barnacle

S. HAGIWARA, R. GRUENER, H. HAYASHI, H. SAKATA, and  
A. D. GRINNELL

From the Division of Marine Biology and the Marine Neurobiology Facility of Brain Research Institute, Scripps Institution of Oceanography, University of California at San Diego, La Jolla, California 92037, and the Department of Zoology, University of California at Los Angeles, Los Angeles, California 90024. Dr. Gruener's present address is Department of Physiology, University of Arizona, Medical School, Tucson, Arizona 85721.

**ABSTRACT** The membrane potential and conductance of the giant muscle fiber of a barnacle (*Balanus nubilus* Darwin) were analyzed in relation to changes in the external (3.5–10.0) and the internal (4.7–9.6) pH, under various experimental conditions. A sharp increase in membrane conductance, associated with a large increase in conductance to Cl ions, was observed when the external pH was lowered to values below 5.0. The ratio of Cl to K conductance in normal barnacle saline is between  $\frac{1}{6}$ – $\frac{1}{7}$  at pH 7.7, whereas at pH 4.0 the ratio is about 6–9. The behavior of the membrane in response to pH changes in a Cl-depleted muscle fiber shows that the K conductance decreases with decreasing external pH for the whole range of pH examined. A steep increase in Cl conductance is also observed when the internal pH of the fiber is lowered below 5.0. The K to Cl conductance ratio increases with increasing internal pH in a manner very similar to that found when the external pH is raised above 5.0. These facts suggest that the membrane is amphoteric with positive and negative fixed charge groups having dissociation constants such that at pH greater than 5, negative groups predominate and cations permeate more easily than anions, while at lower pH positive groups predominate, facilitating the passage of anions through the membrane.

## INTRODUCTION

The resting potential of squid giant axon is determined mainly by the permeability of the membrane to cations, namely K ions. In contrast, the resting potential of frog skeletal muscle fiber is also influenced by Cl ions, since the

membrane is significantly permeable to Cl ions. From the relation between the membrane potential and the external concentrations of K and Cl ions, Hodgkin and Horowicz (1959) have shown that the resting frog muscle membrane is about twice as permeable to Cl as to K ions. The Cl permeability of the resting membrane of the crayfish muscle fiber is as high as that of the frog muscle fiber, whereas it is almost negligible in lobster muscle fibers (Grundfest, 1962). Recently Hagiwara and Takahashi (1967) have shown that Cl permeability is the major factor determining the resting potential in the muscle fibers of certain marine elasmobranch fishes. In this preparation, the Cl permeability is about seven times greater than the K permeability. Clearly, the range of resting Cl permeabilities found in different excitable tissues is considerable.

It has been shown, particularly in ion exchange membrane (Helfferrich, 1962), that the ionic permeability of the membrane is governed by fixed charges within the membrane. When the membrane has positive fixed charges, the passage to anions is facilitated but that to cations is retarded. Therefore the variety of Cl permeabilities, relative to K permeabilities, seen in different excitable membranes may reflect a diversity of membrane fixed charges in different tissues. This also suggests that different Cl and K permeabilities would be found if the fixed charges of the membrane were changed. Since some of the structural groups in biological membranes are weakly ionizable and can be dissociated or associated by changes in pH, it is possible that the membrane fixed charges might be altered by changing the pH of the external or internal environment of the fiber. This would result in a changed permeability to such ions.

Hutter and Warner (1967) found that Cl permeability decreases with decreasing external pH (between 10 and 5) in frog skeletal muscle fiber. In contrast, Cl conductance increases with decreasing external pH in crayfish muscle fibers (Reuben, Girardier, and Grundfest, 1962; De Mello and Hutter, 1966).

In the present work, the membrane permeabilities to K and Cl ions were analyzed as a function of changes in the pH of the external and internal environment of the giant muscle fibers (1–2 mm in diameter) of a barnacle (*Balanus nubilus*). The results support the idea that the major factors governing the ionic selectivity of the membrane are the fixed charges of the membrane originating from amphoteric structural groups.

#### MATERIALS AND METHODS

*Materials* Giant muscle fibers of a barnacle, *Balanus nubilus* Darwin, were used. The earliest part of this work was performed in Chile with specimens obtained at Viña del Mar and the latter part with those obtained from the Pacific Ocean off California. No systematic differences were found in the results obtained with specimens from the two different sources.

*Preparation and Recording* A single muscle fiber was prepared as described previously (Hagiwara and Naka, 1964) and placed in a Lucite chamber (Fig. 1 A). The chamber was made by cutting a channel (*Ch*), 5.5 cm long, 0.5 cm wide, and 0.5 cm deep, into a Lucite plate. One end of the channel was open at the edge of the plate and the other ended blindly in a reservoir (*R*). The fiber was placed on the bottom of the channel. The tendinous end of the fiber was placed near the blind end of the

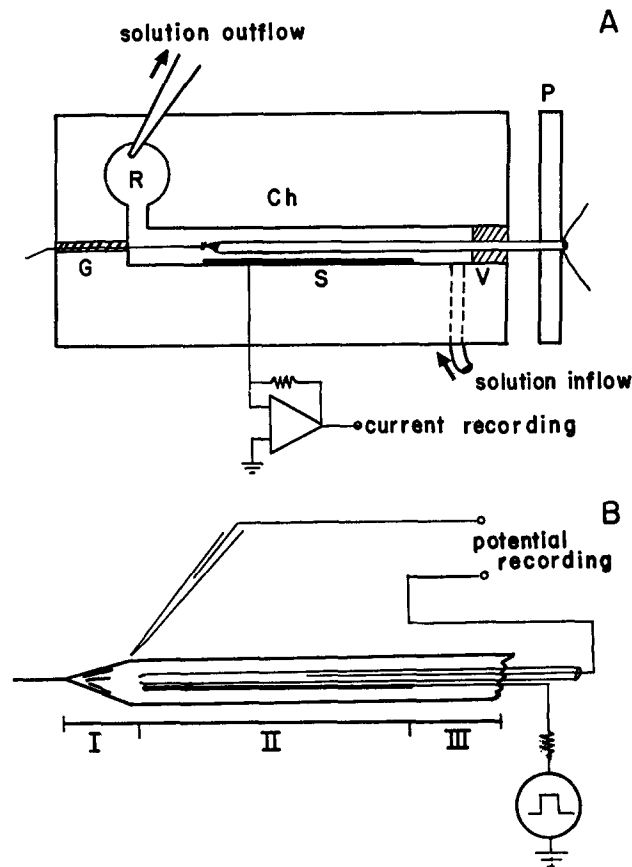

FIGURE 1. Schematic diagram of the experimental arrangement.

chamber and the ligature to the tendon was extended out from the channel through a fine groove (*G*) which was filled with vaseline to prevent saline from leaking out of the channel. The cut end of the fiber was extended to the edge of a thin (3 mm) Lucite plate (*P*) separated from the open end of the channel by about 5 mm. The space between the fiber and the walls of the channel was filled with vaseline for a length of about 5 mm from the open end of the channel. This prevented the saline from leaking out and also provided electrical insulation between the cut end and the rest of the fiber. Test solutions were introduced through a tubular orifice located near the vaseline insulation. Excess solution was removed from the reservoir by suction.

The volume of saline in the channel was about 1 ml and the velocity of saline flow was about 1 ml/sec, allowing the complete exchange of saline in the channel within a few seconds.

Glass micropipettes filled with 3 M KCl and of 5-10 megohms resistance were used for measuring resting potentials. The membrane potential was obtained as a potential difference between a pipette inside and one just outside the fiber. A silver-silver chloride electrode (*S*), immersed in the saline, served as the reference electrode. In order to observe changes in the membrane potential and to measure membrane resistance during changes of test solutions, two internal longitudinal electrodes were used. One was a length of glass tubing of about 50  $\mu$  tip diameter filled with 2 M potassium citrate, instead of KCl, to avoid possible diffusion of Cl from the tubing. The other was a silver wire of 60  $\mu$  diameter attached to the glass tubing with sticky wax. The insulation on this wire was removed over a length of 1.5 cm starting near the opening of the glass tubing and this uninsulated portion was platinized. The platinized wire served as a current-passing electrode and changes in the membrane potential were observed as a potential difference between the internal glass tube electrode and a KCl-filled external micropipette, whose tip was placed just outside the fiber opposite the opening of the internal glass tubing. With this arrangement the fiber membrane should be space-clamped in that part (length II, in Fig. 1 B) of the fiber corresponding to the uninsulated portion of the wire electrode. Since the opening of the glass electrode was located at the end of this stretch, the potential recorded through the glass electrode might not necessarily have followed faithfully that of the membrane under the space clamp. In order to avoid this, the tip of the electrode was always brought close to the tendinous end. Since the fiber ends blindly on this side, the space clamp condition would then have been extended to length I (Fig. 1 B). Membrane resistances were estimated from the ratio between the intensity of the applied current and the potential change produced by it. The estimated areas of (lengths) I and II of the membrane could be used for the calculations of the specific membrane resistance if the current which spread to stretch III of the membrane was neglected. In most experiments however, a specific value of the membrane resistance was not estimated since the major concern was the change in the resistance of the same membrane under different experimental conditions. In a few experiments, changes in membrane resistance were examined by using a double wire electrode. The electrode consisted of two longitudinal cemented silver wires. One wire, used for current injection, had a diameter of 200  $\mu$  and was insulated except for a final length of 1.5 cm, which was platinized. The other wire, used for potential measurements, was 60  $\mu$  in diameter and insulated except for a stretch of 2 mm centered in the platinized region of the first wire. This bare region of the fine wire was chlorided. The membrane current was recorded as an IR drop between the Ag-AgCl electrode in the saline and ground, by using a feedback circuit (Hagiwara, Takahashi, and Junge, 1968; see Fig. 1 A). The potential change and the current intensity were recorded with a Moseley dual ink writer (model 7100 BM), with a response time of about 100 msec. A current pulse duration of 1 sec was used in order to overcome this slow response time of the recording system.

To observe the effect of changes in the internal pH of the fiber a glass pipette of 200  $\mu$  tip diameter was introduced longitudinally into the fiber and the internal solu-

tion was injected along the whole length of the fiber until the fiber diameter became 1.5–2.0 times the original diameter. This technique was discussed previously in detail (Hagiwara and Naka, 1964). Potential changes due to the alteration of the external solution were observed by means of the injection pipette through chlorided silver wire located inside the pipette. To observe the membrane resistance, the double wire electrode described above was introduced after the withdrawal of the injection pipette.

*External Solutions* Compositions of the external saline solutions used for the study of the external pH effects are listed in Table I. In addition to the normal and KCl salines a few modified solutions were used. Calcium was eliminated from some

TABLE I  
COMPOSITIONS OF EXTERNAL SOLUTIONS

Saline	NaCl	Na <sub>2</sub> SO <sub>4</sub>	KCl	K <sub>2</sub> SO <sub>4</sub>	CaCl <sub>2</sub>	MgCl <sub>2</sub>	MgSO <sub>4</sub>
	<i>mM</i>	<i>mM</i>	<i>mM</i>	<i>mM</i>	<i>mM</i>	<i>mM</i>	<i>mM</i>
Normal saline	461.5	—	8	—	20	12	—
KCl saline	—	—	469.5	—	20	12	—
Na saline A	261.4	—	8	—	—	165.4	—
Na saline B	—	230.7	—	4	—	—	165.4
K <sub>2</sub> SO <sub>4</sub> saline	—	—	—	278	—	—	100

Na saline C; Na methanesulfonate, 461.5 mM; K methanesulfonate, 8 mM; Ca gluconate, 20 mM; Mg methanesulfonate, 12 mM; Buffer (10 mM) was added to each solution.

TABLE II  
BUFFER SYSTEMS USED

pH range	Buffer
3.5–4.0	Potassium (sodium) hydrogen phthalate and HCl (H <sub>2</sub> SO <sub>4</sub> )
4.0–6.0	Potassium (sodium) hydrogen phthalate and NaOH (KOH)
6.0–8.5	Tris (hydroxymethyl)aminomethane-maleate and NaOH (KOH)
8.5–10.0	Glycine and NaOH (KOH)

solutions (Na salines A and B, and K<sub>2</sub>SO<sub>4</sub> saline) to avoid its precipitation. In these solutions, the concentration of Mg<sup>++</sup> was raised to prevent the deterioration of the fiber due to the absence of ionized Ca. In order to prevent significant changes in the pH of the solutions, appropriate buffers were added to a final concentration of 10 mM. Table II shows the buffer system used for each pH range (Dawson et al., 1959). Compositions of the external solutions used when the internal pH was changed are listed in Table III. In those experiments Na was completely replaced with Tris (tris(hydroxymethyl)aminomethane). Since Tris does not dissociate completely at pH 7.7, the concentration of Tris-OH was raised by an appropriate amount taking into consideration its dissociation constant. External solutions 1 to 4 are the standard, low-K, low-Cl, and high-K solutions used when the external K and Cl reference concentrations were 120 mM and 450 mM, respectively. In order to obtain desired concentrations of K<sup>+</sup> and Cl<sup>-</sup> these solutions were mixed in the appropriate ratio.

Solutions 5-8 were used for the experiments when the external K and Cl reference concentrations were 450 mM and 120 mM, respectively.

*Internal Solutions* The compositions of the internal solutions are listed in Table IV. The nonbuffered internal solution had the following composition: K<sub>3</sub>-citrate

TABLE III  
COMPOSITIONS OF EXTERNAL SOLUTIONS

Saline	CaCl <sub>2</sub>	MgCl <sub>2</sub>	KCl	KOH	Tris-OH	HCl	Tris-maleate	HMSO <sub>3</sub>
	<i>mM</i>	<i>mM</i>	<i>mM</i>	<i>mM</i>	<i>mM</i>	<i>mM</i>	<i>mM</i>	<i>mM</i>
Solution 1	20	12	120	—	375	266	10	—
Solution 2	20	12	100	—	402	286	10	—
Solution 3	20	12	120	—	385	—	10	375
Solution 4	20	12	386	84	—	—	10	73
Solution 5	20	12	56	394	—	—	10	378
Solution 6	20	12	—	—	551	56	10	326
Solution 7	20	12	—	450	—	—	10	439
Solution 8	20	12	386	64	—	—	10	52

Tris-OH, Trizma base; HMSO<sub>3</sub>, methanesulfonic acid. The final pH was adjusted to 7.7 by adding a small amount of Tris-OH or HMSO<sub>3</sub>.

TABLE IV  
COMPOSITIONS OF INTERNAL SOLUTIONS

	pH	KCl	KOH	Tris-maleate	HMSO <sub>3</sub>	Sucrose	Glycine	KH phthalate	HCl	Tris-OH	Buffer concentration
		<i>mM</i>	<i>mM</i>	<i>mM</i>	<i>mM</i>	<i>mM</i>	<i>mM</i>	<i>mM</i>	<i>mM</i>	<i>mM</i>	
A	7.7	—	200	50	200	546	—	—	—	59	50
B	9.6	120	330	—	165	—	330	—	—	—	330
	9.0	120	330	190	—	295	—	—	—	—	190
	8.0	120	330	260	—	225	—	—	—	—	260
	7.0	120	330	330	5	150	—	—	—	—	330
	6.2	—	220	—	—	139	—	230	120	116	230
	5.5	120	147	—	—	302	—	183	—	—	183
	4.7	—	120	—	29	—	—	330	120	164	330

Tris-OH, Trizma base; HMSO<sub>3</sub>, methanesulfonic acid.

150 mM, sucrose 264 mM. Solution A is the Cl-free internal solution used to observe the effect of changes in the external pH while the internal pH was buffered. Solutions B are used for the study of the changes in the internal pH effects and the K and Cl concentrations are 450 and 120 mM, respectively. The buffer concentration was increased in order to keep the internal pH at the desired level. A small amount of chlorphenol red was added to the solution as a pH indicator in order to monitor the actual

internal pH after injection. All experiments were performed at room temperature (21–23°C).

## RESULTS

### 1. *Membrane Potential and Resistance in Normal External Saline*

The inside negative resting potential of the barnacle muscle fiber, immersed in normal barnacle saline at pH 7.7, ranged between 65 and 73 mv when observed with conventional transmembrane glass micropipettes filled with 3 M KCl. Changing the pH from 7.7, either down to 5.0 or up to 10.0, did not result in any appreciable change in the resting potential. Lowering the pH below 5.0, however, caused a shift of the membrane potential in the negative direction; i.e., the resting potential was increased. This increase started at pH 4.7 and reached a saturation level as the pH approached 4.0. The resting potential at this pH was  $-70$  to  $-73$  mv and was relatively independent of the original resting potential found at pH 7.7. Thus, a marked change in the membrane potential, in the negative direction, was observed when the original potential was low, whereas almost no change was seen if the original membrane potential was already more negative than  $-70$  mv. In order to observe the time course of membrane potential and resistance changes during changes in the external solutions, a longitudinal electrode was used throughout most of the present investigation. A drop of 5–10 mv in the resting potential was often found after insertion of the longitudinal electrode. Histological studies have shown that a number of invaginations are present in the surface membrane of the barnacle fiber (Hoyle and Smyth, 1963). The longitudinal introduction of a relatively large electrode may damage some of these infoldings, in turn creating a leakage which may reduce the resting membrane potential. In spite of relatively low resting potentials, found at pH 7.7 in these fibers, the reduction of pH below 5.0 tended to bring the membrane potential to 70–73 mv. Fig. 2 A and B show records obtained with a longitudinal electrode during changes in the pH of the bathing media. In this fiber the resting potential shifted to  $-63$  mv at pH 4.6 and  $-71$  at pH 4.0, while at pH's higher than 5.0 the potential was about  $-55$  mv. Records in Fig. 2 also show changes in membrane resistance during alterations of the external pH. Constant inward current pulses of 1 sec duration were applied to the membrane at 6 sec intervals. The intensity of the current was chosen so that the amplitude of the potential change was approximately 20 mv at pH 7.7. Each pulse increased the negative membrane potential with an exponential time course as shown in the records of Fig. 2 C. (In Fig. 2 C, the downward deflection indicates negative going potential change, but in all other records in this paper, the negative going potential change is indicated by an upward deflection.) At pH 7.7 the specific membrane resistance estimated from the final amplitude of the potential change was about 1–3 K  $\Omega$  cm<sup>2</sup>. As already mentioned, a num-

ber of infoldings are found in the fiber membrane. If these are taken into consideration, a much smaller value would be found for the specific membrane resistance. In the present work, however, no such estimates were undertaken, since only the relative value of the membrane resistance was of major concern. The resistance did not change appreciably in the range of pH between 5.0 and 10.0. However, it showed a marked decrease when the pH was reduced below 5.0. At pH 4.5 it decreased to about 50% of the value found at

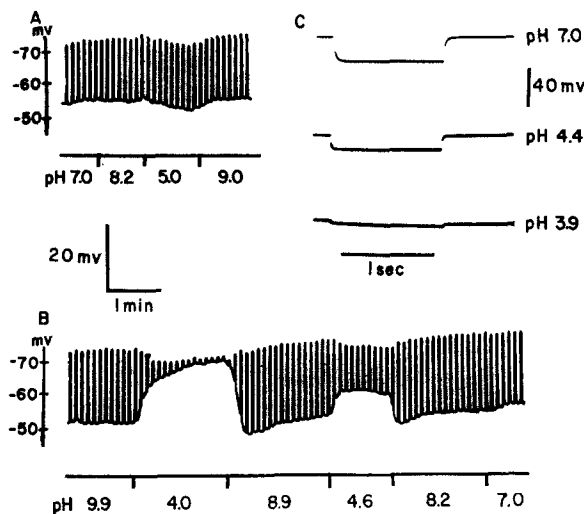

FIGURE 2 A and B. Changes in potential and resistance of the membrane during alteration of pH in normal barnacle saline. Inward current pulses of about 1 sec duration were applied to the membrane at a frequency of about 10/min. The intensity of the current was constant throughout. C. Potential changes in the membrane in normal saline at a faster time scale. The current intensity was the same for all three traces. The pH of the saline was 7.0, 4.4, and 3.9 from the top. All recordings were made with a longitudinal electrode. The upward deflection of the trace in A and B represents the negative going change of the internal potential and in C the positive going potential change.

pH 7.0, and at pH 4.0 the resistance decreased further to about 10% of its value at pH 7.0. The resistance, relative to that found at pH 7.0, was calculated for various pH's and plotted against pH in Fig. 3. All values approximate a single curve, indicating that the response is very constant among different fibers.

The foregoing results show that the membrane resistance decreases sharply at low pH and that this decrease is associated with a shift of the membrane potential toward  $-70$  and  $-73$  mv. This phenomenon involves an increase in the membrane conductance to some ion species—either  $K^+$  or  $Cl^-$ . In order to establish the identity of the ion species involved in the increase of conductance, the relative contributions of  $K^+$  and  $Cl^-$  to the membrane



potential were examined at pH 7.7 and 4.0. To avoid any possible reduction in the resting potential due to the insertion of the longitudinal electrode, the membrane potential was observed with transmembrane micropipettes. Muscle fibers were first equilibrated in the normal saline containing 8 mM K and 533.5 mM Cl and then, at either pH 7.7 or 4.0, the K concentration was altered from 8 mM to 16 and 32 mM by replacing an appropriate amount of the NaCl in the saline with KCl. The Cl concentration was kept constant at 533.5 mM. Observed membrane potentials were plotted against  $\log [K^+]_{out}$  in Fig. 4 A. From these relationships  $\partial V/\partial (\log [K^+]_{out})$  was estimated at  $[K^+]_{out} = 8$  mM and it was found to be 44–47 mv at pH 7.7, and about 5–7 mv at pH 4.0. Corresponding relationships for Cl (Fig. 4 B) were obtained by

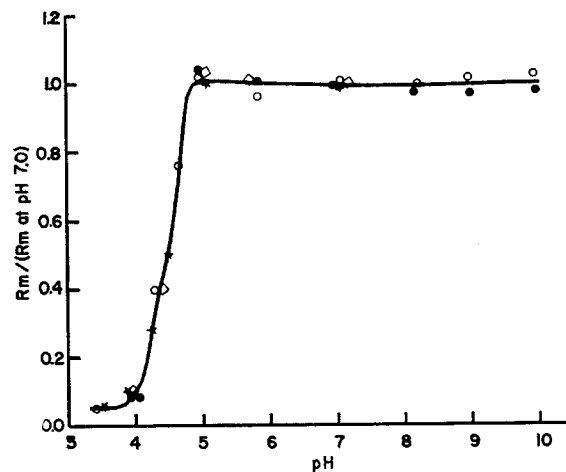

FIGURE 3. The relationship between membrane resistance (relative to that at pH 7.0) and the pH of the external normal barnacle saline. Four different symbols represent data obtained from four different fibers.

reducing  $[Cl^-]_{out}$  from 533.5 mM to 267 and 135 mM, while the K concentration was kept at 8 mM throughout. To obtain solutions of various Cl concentrations, the normal saline and Na saline C (methanesulfonate saline) were mixed in various proportions.  $\partial V/\partial (\log [Cl^-]_{out})$  at  $[Cl^-]_{out} = 533.5$  mM was about  $-7$  mv at pH 7.7 and  $-43$  to  $-47$  mv at pH 4.0. A similar result was also obtained with  $SO_4$  substitution for Cl (Na saline A and B). The above results show that the relative contribution of Cl ions to the resting potential increases when the pH is altered from 7.7 to 4.0. Since this is associated with a decrease in membrane resistance, the evidence indicates an increasing membrane conductance to  $Cl^-$  at pH 4.0. When the fiber is equilibrated in a solution containing the normal concentrations of  $K^+$  (8 mM) and  $Cl^-$  (533.5 mM), the equilibrium potentials of the membrane for  $K^+$  and

$\text{Cl}^-$ , calculated from the Nernst equation, are very close to the resting potential. Previous measurements of the internal K and Cl concentrations of these fibers (Hagiwara, Chichibu, and Naka, 1964) show  $[\text{K}]_{\text{in}} = 157 \text{ mM}$  and  $[\text{Cl}]_{\text{in}} = 32 \text{ mM}$ . These give  $\text{K}^+$  and  $\text{Cl}^-$  equilibrium potentials of about

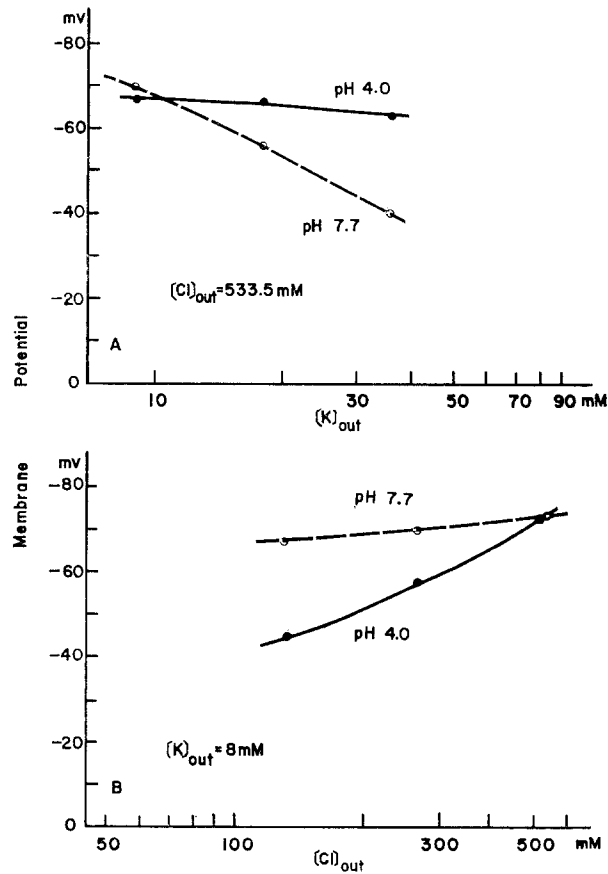

FIGURE 4 A. Relations between the membrane potential and the external K concentration at pH 7.7 and 4.0. B. Relations between the membrane potential and the external Cl concentration at pH 7.7 and 4.0. The Cl concentration was reduced by substituting methanesulfonate for Cl.

-75 and -71 mv, respectively. If Na conductance is neglected, the following relation will be expected (Hodgkin and Horowicz, 1959):

$$\frac{\frac{\partial V}{\partial (\log [\text{K}^+]_{\text{out}})}_{[\text{K}^+]_{\text{out}} = 8 \text{ mM}}}{-\frac{\partial V}{\partial (\log [\text{Cl}^-]_{\text{out}})}_{[\text{K}^+]_{\text{out}} = 8 \text{ mM}, [\text{Cl}^-]_{\text{out}} = 533.5 \text{ mM}}} = \frac{g_{\text{K}}}{g_{\text{Cl}}}$$

where  $g_K$  and  $g_{Cl}$  denote the membrane conductances to  $K^+$  and  $Cl^-$  at  $[K^+]_{out} = 8$  mM and  $[Cl^-]_{out} = 533.5$  mM, respectively. The above measurements indicate that  $g_K/g_{Cl}$  changes roughly from 6–7 to  $\frac{1}{6}$ – $\frac{1}{9}$  for a change of pH from 7.7 to 4.0. If  $g_K$  is assumed to show no appreciable change (as will be shown later  $g_K$  actually decreases slightly at low pH but this is neglected in this discussion), then  $g_{Cl}$  should increase by a factor of 36–63 when the pH is reduced from 7.7 to 4.0 and the total membrane resistance should decrease to about  $\frac{1}{6}$ – $\frac{1}{9}$  of the value found at pH 7.7. The observed ratio between the membrane resistance at pH 4.0 and 7.7 was approximately 0.1, which is not very different from the above figure. The conclusion reached from the foregoing experiments is, therefore, that the Cl conductance shows a drastic increase at pH below 5.0.

### 2. *Aftereffects of Low pH Exposure and Polyvalent Cations*

When the pH of the bathing solutions of the fibers was brought back to higher values (for example 7.7) after exposure of the fibers to low pH (3.9–4.7), the membrane resistance, as a rule, became significantly higher than that originally found at the higher pH's, and thereafter, declined slowly (in 2–3 min) to the original value. In spite of such a rebound-like phenomenon, the recovery was usually complete; i.e., the low pH effect was reversible for the pH values above 3.9. When a fiber was exposed to pH below 3.5, however, a rebound-like phenomenon was no longer seen upon returning to the neutral pH and the resistance stayed at relatively low values even after the pH was raised. In many cases, the recovery was not complete even after 5–10 min. In the present experiments, therefore, most observations were limited to pH's above 3.9.

The failure of the membrane resistance to increase after an early return of the fiber from extremely low (below 3.5) to normal pH could be prevented by introducing polyvalent cations into the bathing solution. This failure became significantly less when the external solution contained 100 mM Mg, and it was almost completely eliminated when 3 mM  $LaCl_3$  was added to the saline. Thus, some polyvalent cations protect the fiber membrane from the after effect of immersion in very low pH. The protection effect was different for various polyvalent cations. When compared at the same concentration,  $La^{+++}$  was much more effective than  $Ca^{++}$  or  $Mg^{++}$ .

### 3. *Effects of External pH in K-Rich Media*

Fibers contracted vigorously when immersed in KCl saline (pH 7.7). This contraction decayed slowly and an almost complete relaxation was found after 5–10 min. After such treatment the resting potential of fibers was –5 to –7 mv. The intensity of the current used for resistance measurements was adjusted so that the amplitude of the potential change was less than 10 mv at

pH 7.7. When pulses of higher intensities were used, inward and outward current pulses of the same intensity usually gave potential changes of different amplitudes. Fig. 5 A (filled circles) shows the relation between the membrane resistance—relative to the one found at pH 7.0—and pH, obtained in the KCl saline. The resistance decreased sharply when the pH was reduced below 5.0.

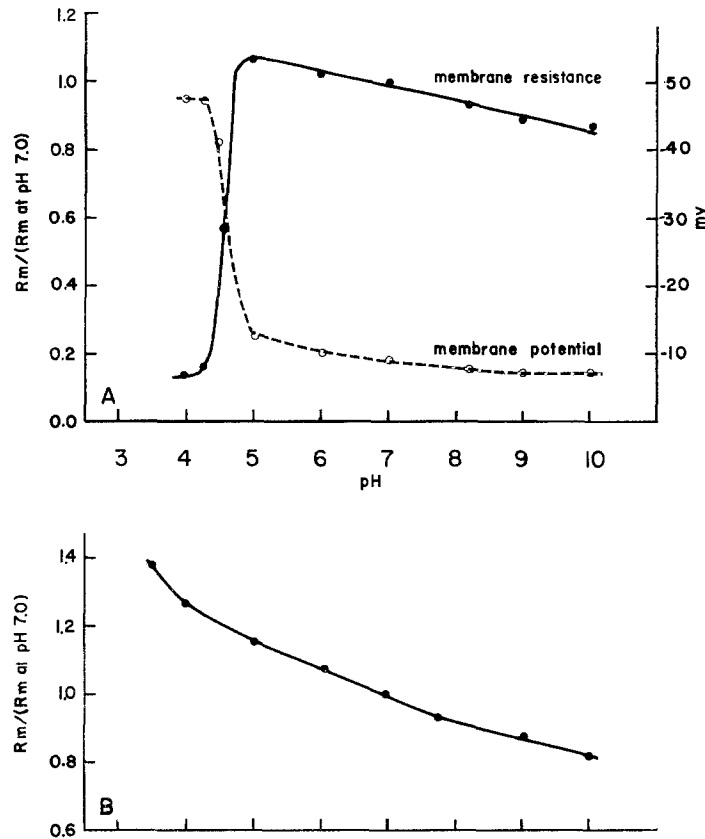

FIGURE 5 A. Relations between the membrane resistance (relative to that at pH 7.0) (filled circles) and membrane potential (open circles) and the pH of the external KCl saline. B. Relation between the membrane resistance (relative to that at pH 7.0) and the external pH in  $K_2SO_4$  saline. The internal Cl has been depleted in this fiber by soaking in  $SO_4$  saline for 24 hr.

This behavior of the membrane was similar to that found in normal saline. However, a slightly different behavior was found with the pH values higher than 5.0. In normal saline the membrane resistance was practically constant for this range but in KCl saline it decreased with the increase in pH. The change was almost linear with pH and the value of the slope was about 6% of the resistance at pH 7.0 for 1 pH unit change. The relationship between

relative resistance and pH, in K-rich saline, also showed very little variation among different fibers.

The membrane potential showed a characteristic dependence on pH in the KCl saline. Between pH 10.0 and 5.0 the resting potential shifted in the negative direction as the pH was reduced, but the change per pH unit was always small. The rate of change increased rapidly when the pH was reduced below 5.0 and the membrane potential soon reached a saturation level at about pH 3.9. These results are illustrated by open circles in Fig. 5 A, and were obtained from a fiber in which the membrane potential changed from  $-9$  mv at pH 7 to  $-47$  mv at the saturation level (pH 3.9). Fibers were always examined after less than 30 min immersion in KCl saline (pH 7.7) and did not show large deviations from the above values. The negative shift of the membrane potential below pH 5.0 can be explained in terms of an increase in membrane conductance to Cl ions. Since the Cl concentration of the KCl saline is the same as that of the normal saline, and the K concentration is nearly 60 times greater than normal, the equilibrium potential for Cl<sup>-</sup>, shortly after the immersion of the fiber, should be far more negative than the K equilibrium potential, which should, in fact, be more positive than the observed resting potential at pH 7.7. Since the K conductance dominates the Cl conductance at higher pH's, the membrane potential comes close to the K equilibrium potential. If immersion of the fibers in low pH solutions results in an increase in Cl conductance, the membrane potential should shift towards the Cl equilibrium potential. Prolonged immersion in KCl saline (pH 7.7), however, should result in a redistribution of Cl ions between the inside and the outside of the fiber and this should shift the Cl equilibrium potential in the positive direction toward the K equilibrium potential. In accord with this expectation, a less negative membrane potential value was found when the low pH solution was applied after prolonged immersion of the fiber in KCl saline (pH 7.7). In a representative experiment, one fiber was immersed in KCl saline (pH 7.7) for 20 min, another for 3.5 hr, before changing to low pH KCl saline. The membrane potential at low pH was  $-48$  mv for the former and  $-16$  mv for the latter fiber, while the corresponding potentials at pH 7.7 were  $-9$  mv and  $+3$  mv, respectively. This agrees with the expectation that the internal Cl concentration increases during prolonged immersion of the fiber in KCl saline. The rate of increase is, however, much slower in the barnacle muscle fiber than that found in frog muscle fibers (Hodgkin and Horowicz, 1959). This may be due to the large size of the fiber. This allows us to assume that the Cl equilibrium potential in the barnacle fiber is essentially unchanged for a period of 15–20 min. The large conductance increase found at low pH is associated with the membrane potential change of about  $-38$  mv. This might indicate that the conductance increase was at least in part due to the change in the membrane potential. However, this was not the

case since the current-voltage relation observed at low pH (pH 4.0) was practically linear for this range of membrane potential.

The potential change observed for the pH range between 5.0 and 10.0, however, cannot be explained in terms of the conductance change of the membrane to Cl ions since the negative shift of the membrane potential is associated with an increase in membrane resistance. Instead, this potential behavior apparently reflects an increase in the membrane conductance to K ions with increasing pH, the Cl conductance remaining essentially constant. Under this condition the membrane potential should approach the K equilibrium potential; i.e., the potential would shift, as it does, in the positive direction as the pH is increased.

If the reduction of the membrane resistance found at pH's below 5.0 is due to an increase in Cl conductance, and if the resistance increase associated with the decrease from pH 10 to pH 5 is due to the change in the K conductance, then the former should disappear and the latter should remain when Cl conductance is totally eliminated. To test this, the behavior of the membrane in a Cl-free medium was examined by replacing Cl with SO<sub>4</sub> (K<sub>2</sub>SO<sub>4</sub> saline). The fiber was kept in this solution at pH 7.7 for 24 hr. The resting potential of the fiber measured about +10 mv. Changing the pH between 3.5 and 10.0 did not result in any appreciable change in membrane potential. The membrane resistance however, increased with decreasing pH over the entire range of pH examined (Fig. 5 B). The resistance increased rapidly when the pH was decreased below 5.0 where, in contrast, a marked decrease had been found in the KCl medium. The result indicates that the decreasing resistance at low pH, in Cl-containing salines, is due exclusively to the increase in Cl conductance of the membrane, and the increasing resistance with decreasing pH (between 10.0 and 5.0) is due to a decrease in the K conductance. In normal saline (8 mM K), the membrane resistance was relatively constant for the pH range between 5.0 and 10.0. It seems probable to us that the K conductance may similarly depend on pH in normal saline, but that the dependence is masked by the constant Cl conductance or by the leakage due to injury, since K conductance itself seems to be smaller in normal saline than in K-rich media.

#### 4. *K and Cl Conductances at Different Internal pH's*

In the foregoing experiments, the pH of the external medium was altered. In a few experiments K-methanesulfonate solution containing chlorophenol red was injected into the fiber prior to the external pH changes. When the pH of the external saline was neutral, the color inside the fiber was red corresponding to pH 7-8. The color was unchanged while the external pH was altered in the range between 3.9 and 10.0. This result agrees with the one obtained by Caldwell (1958) who found that the internal pH of crab muscle fibers is close

to 7.0 in normal saline solution and is not greatly affected by changes in the pH of the external solution. In several other cases, the injected solution contained 50 mM buffer at pH 7.7 (internal solution A). The relationship between membrane resistance and the external pH is the same as that obtained with internally unbuffered fibers. These results suggest that the pH change in the external medium is the major cause for the membrane changes observed in the preceding experiments. This, however, does not preclude changes in the internal pH of the fiber just adjacent to the membrane.

In order to examine the relationship between the K and Cl conductances at different internal pH's, internal solutions of various pH's (internal solutions

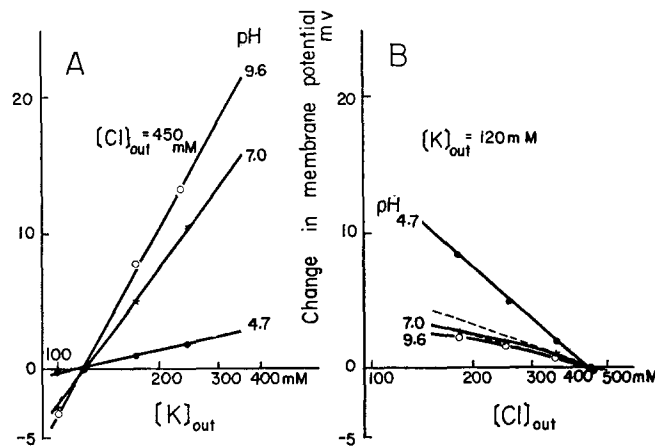

FIGURE 6 A. Relations between the change in the membrane potential and the external K concentration at three different internal pH's. The Cl concentration was kept at 450 mM throughout. B. Relations between the change in the membrane potential and the external Cl concentration at three different internal pH's. The K concentration was kept at 120 mM throughout. The reference membrane potential was the one in the solution containing 120 mM K and 450 mM Cl in both cases. The internal solutions injected into the fiber contained 450 mM K and 120 mM Cl.

B) were injected into the fiber and changes in the membrane potential were observed when either the K or Cl concentration was altered in the external solution at pH 7.7. The internal solution contained 450 mM K and 120 mM Cl; it was injected into the fiber until its diameter became 1.5–2.0 times the original diameter, thus bringing the actual internal concentrations of K and Cl close to those of the injected solution. Since the K and Cl concentrations in the external solution (solutions 1–4) were 120 and 450 mM, respectively, the equilibrium potential for  $K^+$  and  $Cl^-$  should not be very different and therefore, the ratio between  $\partial V/\partial (\log [K^+]_{out})$  and  $-\partial V/\partial (\log [Cl^-]_{out})$  (at  $[K]_{out} = 120$  mM and  $[Cl]_{out} = 450$  mM) should give an approximate value of  $g_K/g_{Cl}$  for these K and Cl concentrations. In this experiment external Na

has been removed and replaced with Tris. In Fig. 6 A changes in membrane potential from those found at  $[K^+]_{out} = 120$  mM and  $[Cl^-]_{out} = 450$  mM are plotted against the external K concentration for three different internal pH's. The external K concentration was altered from 120 to 100, 170, and 240 mM by keeping Cl concentration at 450 mM. The slope ( $\partial V/\partial (\log [K^+]_{out})$ ) increases as the internal pH increases. A similar set of experiments was performed by changing the external Cl concentration from 450 to 350, 250, and

TABLE V  
 $\partial V/\partial (\text{LOG } [K^+]_{out})$ ,  $-\partial V/\partial (\text{LOG } [Cl^-]_{out})$ ,  
 AND MEMBRANE POTENTIAL

Internal pH	(1) $\partial V/\partial (\log [K^+]_{out})$	(2) $-\partial V/\partial (\log [Cl^-]_{out})$	(3) Ratio (1)/(2)	(4) Membrane potential
	<i>mv</i>	<i>mv</i>		<i>mv</i>
9.6	46	6.7	6.9	-23
9.6	42	7.0	6.0	-22
9.0	43	8.6	5.0	-22
9.0	45	7.0	6.4	-21
8.0	38	8.5	4.5	-21
8.0	39	8.4	4.6	-22
8.0	34	9.1	3.7	-20
7.0	33	10-11	3.3-3.0	-20
7.0	32	6.5	4.9	-20
7.0	33	8.5	3.8	-20
6.2	36	11.3	3.2	-23
5.5	26	9	2.9	-19
5.5	30	10	3.0	-21
4.7	5.8	22	0.26	-23
4.7	10	12	0.8	-23

Slopes and membrane potentials were at  $[K^+]_{out} = 120$  mM and  $[Cl^-]_{out} = 450$  mM.

180 mM; the results are shown in Fig. 6 B. The negative value of the slope increases with decreasing internal pH.  $\partial V/\partial (\log [K^+]_{out})$  and  $-\partial V/\partial (\log [Cl^-]_{out})$  were then estimated in the same fiber at  $[K^+]_{out} = 120$  mM and  $[Cl^-]_{out} = 450$  mM and they are listed in Table V together with the membrane potentials at these external  $K^+$  and  $Cl^-$  concentrations.

The ratio between the two slopes was calculated in order to estimate  $g_K/g_{Cl}$ . Since changes of the ratio from 1.0 to 2.0 and from 1.0 to  $1/2$  should have an equally important meaning, the logarithm of the ratio was plotted against the internal pH instead of the ratio itself (Fig. 7, filled circles). The ordinate



increases with increasing internal pH over the entire range of pH examined (pH 4.7–9.6). However, the change was much more rapid for the range of pH below 5.0. In other words, the relative conductance of Cl ions to K ions shows a drastic increase when the internal pH is reduced below 5.0. This behavior of the Cl conductance is very similar to the one found with the low external pH. In a few experiments, the membrane resistances of fibers injected with solutions of pH 4.7 and 7.0 were compared. Much smaller resistance values were always found in fibers injected with a low pH solution ( $60 \pm 25 \Omega \cdot \text{cm}^2$  at pH 4.7 and  $400 \pm 150 \Omega \cdot \text{cm}^2$  at pH 7.7, examined with nine fibers for each pH). Therefore, the drastic decrease of the conductance ratio at low pH is primarily due to the increase in Cl conductance as is the case with low external pH solutions. For internal solutions with a pH above 5.0, the ratio of  $g_{\text{K}}$  to

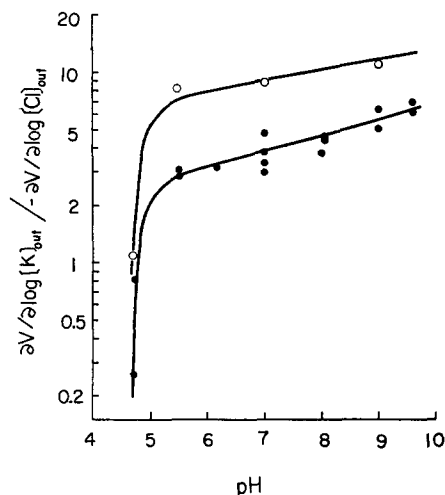

FIGURE 7. The ratio between  $\partial V / \partial (\log [K^+]_{\text{out}})$  and  $-\partial V / \partial (\log [Cl^-]_{\text{out}})$  is plotted on a logarithmic scale against the internal pH. Data represented by filled and open circles were obtained when  $[K^+]_{\text{out}} = 120$  mM and  $[Cl^-]_{\text{out}} = 450$  mM and  $[K^+]_{\text{out}} = 450$  mM and  $[Cl^-]_{\text{out}} = 120$  mM, respectively.

$g_{\text{Cl}}$  increases with increasing pH much more gradually. Since in the present experiments it was not possible to observe the membrane resistance of the same muscle fiber at different internal pH's, individual variation in membrane resistance among different fibers made it difficult to conclude whether these changes are due to the change in the K or Cl conductance. However, judging from the result obtained with the external pH changes, it seems more likely that the increase in the conductance ratio is due to the increase in the K conductance rather than a decrease in the Cl conductance with increasing internal pH. Open circles in Fig. 7 show the result obtained with external solutions containing 450 mM K and 120 mM Cl. Although the relative K conductance is higher than the Cl conductance at a given pH, the general shape of the curve is very similar to that obtained at  $[K^+]_{\text{out}} = 120$  mM and  $[Cl^-]_{\text{out}} = 450$  mM. From the foregoing results it is concluded that the

behavior of the K and Cl permeabilities of the membrane at different internal pH's is very similar to that found with different external pH's.

Table V indicates that membrane potentials, obtained in external solution containing 120 mM K and 450 mM Cl, show little change as the internal pH is changed. This probably indicates that the equilibrium potentials for the K and Cl ions are in fact very similar under these conditions. Theoretically the sum of  $\partial V/\partial(\log[K^+]_{\text{out}})$  and  $-\partial V/\partial(\log[Cl^-]_{\text{out}})$  should be about 58 mv if  $K^+$  and  $Cl^-$  are the only permeant ions (Hodgkin and Horowicz, 1959). The sum is, in fact, close to 58 mv at high internal pH (52.7 mv and 49 mv at pH 9.6). However, it becomes smaller as the internal pH is reduced. A similar tendency was often found in the experiments in which the external pH was changed. This may indicate that membrane leakage due to longitudinal electrode insertion becomes greater at low pH. Since the sum of the K and Cl conductances at low pH (4.7) is larger than that at neutral pH (7.7), the leakage effect should decrease at low pH if the leakage conductance is independent of pH. However, the experimental results are in the opposite direction and this indicates that the leakage conductance should become much larger at low pH. This may suggest that the conductance of some other ions such as  $H^+$  may contribute to the membrane conductance when the internal  $H^+$  concentration is raised. In the present experiments, the internal pH of the fiber was buffered at pH's different from the normal internal pH. However, no experiment was performed to bring back the internal pH to its original value; in other words reversibility was not checked. In order to test for any progressive deterioration at extremely low (pH 4.7) or high (pH 9.6) internal pH's, membrane resistance and potential were repeatedly measured for a period of 45 min while alterations of the external  $K^+$  and Cl concentrations were undertaken. No significant progressive changes were ever found.

#### DISCUSSION

The present results show that the Cl conductance of the barnacle muscle fiber membrane undergoes a drastic increase when either the external or the internal pH is reduced below 5.0, while the K conductance increases with increasing pH over the whole range of pH examined.

The effects on the membrane of varying the pH of the external media have been observed in several other tissues. In frog skeletal muscle fibers, Hutter and Warner (1967) have shown that membrane conductance decreases with decreasing pH in the range between pH 10.0 and 5.0. This conductance decrease was found to be due to a decrease in Cl conductance; therefore, the pH behavior of the Cl conductance of the frog muscle fiber, in this range of pH, is in the direction opposite to that found for the barnacle fiber at pH below 5.0. The present data on barnacle fiber do not, however, give much information on the behavior of the Cl conductance for the external pH range of 10-5,

since the relative contribution of Cl conductance to the total membrane conductance was very small compared to that of K conductance. The experiments in Cl-free, K-rich media suggest that Cl conductance in the pH range between 5.0 and 10.0 does not decrease with decreasing pH, at least not to the same extent as it does in the frog fiber. Reuben, Girardier, and Grundfest (1962) have shown that in crayfish muscle fibers the Cl conductance decreases when the external pH is raised from the normal neutral pH to pH 10.0. This suggests that the change in Cl conductance in crustacean muscle fibers may be in the opposite direction to that found in frog skeletal muscle fibers, even in the range of pH above 5.0. De Mello and Hutter (1966) have shown that in certain crustacean (*Astacus*) muscle fibers the anion conductance increases when the external pH is reduced from pH 8.5 to 4.5. This result agrees with our findings in barnacle muscle fibers. A similar increase in Cl conductance at low pH has been observed in the epithelial membrane of the rabbit gall bladder (Wright and Diamond, 1968). In this preparation the Cl conductance becomes comparable to the K conductance at about pH 3. No data are available for the effect of changes in the internal pH in other tissues. The present results show that such effects are very similar to those found for the external pH.

The behavior of Cl and K conductances in the barnacle muscle fiber membrane, as well as in the gall bladder epithelial cell membrane, at low pH, is in accord with the classical idea of the amphoteric membrane. The selective permeability of the membrane is ascribed to the presence of fixed charges which attract and afford passage to oppositely charged ions but exclude cations. If the structural groups of the membrane are weakly ionizable, the sign and density of fixed charges should vary with pH and this should, in turn, result in a change in ion permeability. Lowering the pH should reduce or eliminate negative fixed charges and increase or unmask positive charges originating from these weakly ionized groups. Therefore, lowering the pH should result in an increase in anion permeability. The maximum slope of the membrane conductance vs. pH is found at about 4.0. This fact indicates that the pK of the structural group responsible for Cl conductance changes seems to be about 4.0. However, it may be unwise to estimate the chemical nature of such a group from this value alone since it represents the pH of the external solution but not necessarily that of the membrane proper.

The authors wish to thank Dr. J. Diamond for his valuable suggestions throughout this study.

The present study was aided by United States Public Health Service Grant NB-03536 and United States Air Force Grant AF-AFOSR-933-66 to Dr. Hagiwara and also Public Health Service Grant NB06232 to Dr. A. Grinnell.

We are particularly grateful to the Convenio Universidad de Chile—University of California for making possible the portion of this work done in Chile, and to the staff of the Laboratory of Cellular Physiology, Monte Mar, Chile, for their generous assistance.

*Received for publication 3 June 1968.*

## REFERENCES

- CALDWELL, P. C. 1958. Studies of the internal pH of large muscle and nerve fibres. *J. Physiol. (London)*. **142**:22.
- DAWSON, R. M. C., D. C. ELLIOTT, W. H. ELLIOTT, and K. M. JONES. 1959. Data for Biochemical Research. Oxford University Press, Oxford.
- DE MELLO, W., and O. F. HUTTER. 1966. The anion conductance of crustacean muscle. *J. Physiol. (London)*. **183**:11P.
- GRUNDFEST, H. 1962. Ionic transport across neuronal and non-neuronal membranes. In Properties of Membranes and Diseases of the Nervous System. Donald B. Tower, editor. Springer Publishing Co., Inc., New York. p. 71.
- HAGIWARA, S., CHICHIBU, S., and NAKA, K. 1964. The effects of various ions on resting and spike potentials of barnacle muscle fibers. *J. Gen. Physiol.* **48**:163.
- HAGIWARA, S., and K. NAKA. 1964. The initiation of spike potential in barnacle muscle fibers under low intracellular  $Ca^{++}$ . *J. Gen. Physiol.* **48**:141.
- HAGIWARA, S., and K. TAKAHASHI. 1967. Resting and spike potentials of skeletal muscle fibres of salt-water elasmobranch and teleost fish. *J. Physiol. (London)*. **190**:499.
- HAGIWARA, S., K. TAKAHASHI, and D. JUNGE. 1968. Excitation-contraction coupling in a barnacle muscle fiber as examined with voltage clamp technique. *J. Gen. Physiol.* **51**:157.
- HELFERICH, F. 1962. Ion Exchange. McGraw-Hill Book Co., New York.
- HODGKIN, A. L., and P. HOROWICZ. 1959. The influence of potassium and chloride ions on the membrane potential of single muscle fibers. *J. Physiol. (London)*. **148**:127.
- HOYLE, G., and T. SMYTH. 1963. Neuromuscular physiology of giant muscle fibers of a barnacle, *Balanus nubilus* Darwin. *Comp. Biochem. Physiol.* **10**:291.
- HUTTER, O. F., and A. E. WARNER. 1967. The pH sensitivity of the chloride conductance of frog skeletal muscle. *J. Physiol. (London)*. **189**:403.
- REUBEN, J. P., L. GIRARDIER, and H. GRUNDFEST. 1962. The chloride permeability of crayfish muscle fibers. *Biol. Bull.* **123**:509.
- WRIGHT, E., and J. DIAMOND. 1968. Effects of pH and polyvalent cations on the selective permeability of gallbladder epithelium to monovalent ions. *Biochim. Biophys. Acta*. In press.