

Effects of Epinephrine on the Pacemaker Potassium Current of Cardiac Purkinje Fibers

RICHARD W. TSIEN

From the Department of Physiology, Yale University School of Medicine, New Haven, Connecticut 06510

ABSTRACT Epinephrine promotes spontaneous activity in cardiac Purkinje fibers through its action on the pacemaker potassium current (i_{K_2}). The mechanism of the acceleratory effect was studied by means of a voltage clamp technique. The results showed that the hormone speeds the deactivation of i_{K_2} during pacemaker activity by displacing the kinetic parameters of i_{K_2} toward less negative potentials. This depolarizing voltage shift is the sole explanation of the acceleratory effect since epinephrine did not alter the rectifier properties of i_{K_2} , or the underlying inward leakage current, or the threshold for i_{Na} . The dose dependence of the voltage shift in the i_{K_2} activation curve was similar in 1.8 and 5.4 mM $[Ca]_o$. The maximal voltage shift (usually ~ 20 mV) was produced by epinephrine concentrations of $> 10^{-6}$ M. The half-maximal effect was evoked by 60 nM epinephrine, nearly an order of magnitude lower than required for half-maximal effect on the secondary inward current (Carmeliet and Vereecke, 1969). The β -blocker propranolol (10^{-6} M) prevented the effect of epinephrine (10^{-7} M) but by itself gave no voltage shift. Epinephrine shifted the activation rate coefficient α_s to a greater extent than the deactivation rate coefficient β_s , and often steepened the voltage dependence of the steady-state activation curve. These deviations from simple voltage shift behavior were discussed in terms of possible mechanisms of epinephrine's action on the i_{K_2} channel.

INTRODUCTION

Epinephrine promotes spontaneous activity in cardiac Purkinje fibers through its acceleratory effect on the pacemaker depolarization (Otsuka, 1958). This positive chronotropic action is quite dramatic and its mechanism is of considerable interest. In one of the earliest studies, Trautwein and Schmidt (1960) looked for an effect of epinephrine on the rapid sodium current which underlies the upstroke of the action potential. No change in the sodium current inactivation curve (Weidmann, 1955 *a*) was found. Similarly, epinephrine did not significantly alter the current-voltage relationship of Purkinje fibers in sodium-free solution (Kassebaum, 1964).

More recently, attention has turned to the slow potassium current which underlies the pacemaker depolarization (Deck and Trautwein, 1964; Vassalle, 1966; Noble and Tsien, 1968). This component, i_{K_2} , is often referred to as the pacemaker potassium current. Its time and voltage dependence can be described (Noble and Tsien, 1968) by a Hodgkin-Huxley variable, s , which changes from near zero to unity between -90 and -60 mV, the range of potentials over which pacemaker activity occurs. i_{K_2} activates rather quickly during the action potential plateau and only plays an important role in the ensuing diastolic depolarization. After the action potential, repolarization to negative levels (near -90 mV) causes i_{K_2} deactivation and a slow decay of outward current. The slow decay progressively unmasks a steady inward background current (probably carried by sodium ions) that produces the slow pacemaker depolarization. Thus, the fall of i_{K_2} is the crucial rate-limiting process in the pacemaker potential.

The characterization of i_{K_2} and its role led to the suggestion that this component might be epinephrine sensitive. Hauswirth et al. (1968) found that, in fact, i_{K_2} was modified by epinephrine, and that the alteration in the kinetics of this component was appropriate to account for the acceleratory effect. The present paper extends these preliminary observations.

METHODS

The experiments were carried out in Purkinje fibers from calf hearts, but were similar in approach to the previous work of Hauswirth et al. (1968) in sheep Purkinje fibers. The pacemaker potassium current, i_{K_2} , was analyzed by means of a two-microelectrode voltage clamp technique in shortened preparations (Deck et al., 1964). The experiments studied the influence of epinephrine during maintained exposure to various concentrations of the drug.

Preparations and Solutions

Calf hearts were obtained at a local slaughterhouse. Hearts were removed from the animals within 3–5 min of sacrifice, at a time when vigorous beating still takes place. The ventricles were opened and rinsed; the hearts were then transported back to the laboratory in a large volume of Tyrode's solution that was vigorously oxygenated en route and kept near 0°C with frozen cubes of Tyrode's. These procedures during the 25-min period before dissection seemed to improve the eventual viability of Purkinje fiber preparations. At the laboratory, the ventricles were rinsed with warm Tyrode's solution, and short segments of free-running Purkinje tissue were excised. The preparations were incubated in continuously oxygenated Tyrode's solution at 35°C . At least 1 h was allowed for healing over and equilibration before impaling the first preparation.

As in the work of Dudel et al. (1967), a Tyrode's solution containing 5.4 mM $[\text{Ca}]_o$ was generally used. This concentration is about three times the normal plasma level, but it is helpful experimentally since calcium ions promote healing over and prolong the survival of preparations under voltage clamp conditions. The composition of the Tyrode's solution was as follows: 150 mM Na, 4 mM K, 5.4 mM Ca, 0.5 mM

Mg, 155.8 mM Cl, 5 mM glucose, and 10 mM Tris-maleate (pH 7.2–7.4). In some of the experiments only 1.8 mM CaCl_2 was used. (See figure legends.)

Epinephrine bitartrate (Sigma Chemical Co., St. Louis, Mo.), isoproterenol bitartrate (Sigma), and phenylephrine HCl (Sigma) were the catecholamines used. These compounds were weighed out shortly before use in each particular experiment. Catecholamine solutions also included Na_2EDTA (4×10^{-5} M) to retard oxidation. l-propranolol HCl (Ayerst Laboratories, New York, N. Y.) was sometimes used as a β -adrenergic blocking agent, and was made up from a refrigerated stock solution. Tetrodotoxin (Sankyo, Tokyo, Japan) 10^{-6} g/ml, and D600 (α -isopropyl- α [(N-methyl-N-homoveratryl)- γ -aminopropyl]-3,4,5-trimethoxyphenylacetoneitrile · HCl, Knoll, Ludwigshafen am Rhein, Germany) 5×10^{-7} g/ml, were used in some experiments to inhibit inward current components which might interfere with the analysis of i_{K_2} .

All drug-containing solutions were kept at room temperature and warmed to bath temperature by water-jacketed inflow tubes just before entering the bath itself. During the experiments, the test solutions were preoxygenated and flowed continuously through the small Plexiglass chamber. The chamber contained about 0.8 ml solution and was water jacketed to maintain the temperature near 35–36°C. The bathing temperature was monitored by a bead thermistor and the resulting signal was continuously registered on the chart recorder. During a given experiment the temperature was kept constant to within $\pm 0.2^\circ\text{C}$.

Current and Voltage Recording

The voltage clamp technique of Deck et al. (1964) was employed. Short Purkinje fiber preparations (1–2 mm in length) were impaled by two intracellular microelectrodes. The current-passing microelectrode contained 1.5 M potassium citrate and was inserted midway between the cut ends of the preparation. About 300 μm away the preparation was impaled by a second microelectrode, containing 3 M KCl. This microelectrode was connected to a unity gain electrometer for measurement of intracellular potential. The resulting voltage signal was amplified by a very low-drift amplifier (which also serves as a preamplifier for the chart recorder) and then applied to the input of the voltage clamp amplifier. (In earlier work (McAllister and Noble, 1966; Noble and Tsien, 1968) the input to the voltage clamp amplifier was taken from the oscilloscope's cathode follower output; this procedure is less satisfactory because of voltage drifts in the oscilloscope amplifiers.) The input of the voltage clamp amplifier also received rectangular command pulses whose amplitude and duration are controlled by the experimenter.

The voltage clamp amplifier (Melcor no. 1957, Melcor Electronics Corp., Farmingdale, N. Y.) had an output voltage range of ± 110 V. The output was connected to the current-passing microelectrode through a mercury-wetted relay which was automatically open circuited by a safeguard circuit, after a suggestion of New and Trautwein (1972). The present circuit was designed and built by Mr. H. Abildgaard and is shown here (Fig. 1) because it may be of general use.

A neon bulb (NB) was directly connected to the clamp amplifier output, and fired when the output voltage exceeded ± 100 V for a millisecond or so. The firing triggered

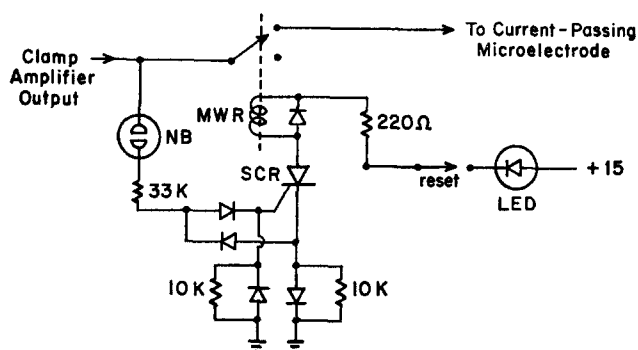

FIGURE 1. A simple circuit for safeguarding the preparation against damage.

a silicon-controlled rectifier (SCR) in series with the relay coil (MWR) and a light-emitting diode (LED), which signaled the overload condition. These devices remained "latched" in the conducting state, and the clamp amplifier output was interrupted, until the experimenter reset the circuit by briefly opening the reset switch.

The safeguard circuit was valuable in increasing the chances of carrying out pharmacological experiments lasting 3–4 h. In epinephrine-containing solutions, preparations show more vigorous contractile responses to depolarizing pulses, which tend to dislodge one or both of the microelectrodes, thereby causing a damaging surge of current from the clamp amplifier. The safeguard circuit curtailed the current surges, and in most cases, the impalements recovered within tens of seconds to their original state.

The transmembrane current was measured by an operational amplifier circuit connected to the bath by a Ag/AgCl pellet. The circuit holds the bath potential at virtual ground, and gives an output signal proportional to membrane current. This signal was recorded together with the membrane potential signal on two devices: a Tektronix 5031 storage oscilloscope (Tektronix, Inc., Beaverton, Ore.), and a Brush 440 four-channel chart recorder (Gould, Inc., Instrument Systems Div., Cleveland, Ohio). The recorder had a frequency response that is 3 dB down at 125 Hz. In most experiments, the current signal was additionally filtered with an RC circuit and displayed on one chart-recorder channel at high amplification. The filtering (τ usually 7 ms) reduced noise, but did not affect the measurement of i_{K_2} , since this component has a relaxation time of ~ 1 s over the range of potentials where current changes were measured.

Experimental Procedure and Possible Errors

The analysis of the kinetic and rectifier properties of i_{K_2} has been extensively described elsewhere (Noble and Tsien, 1968; for a more explanatory account, see Tsien, 1970). In operational terms, the properties of i_{K_2} were investigated by applying a series of rectangular voltage pulses of different magnitudes from a holding potential within the diastolic range (near -75 mV). A typical run required 20 min or more in a given test solution; the rate of data acquisition was very much limited by the slow time-course of i_{K_2} . To guard against progressive changes in experimental properties over the course of the run, certain test pulses were repeated at the beginning and end of the run to

show reproducibility. Solution changes were rapidly completed because of the small size of the experimental chamber, but to ensure steady conditions, a new test solution was allowed to flow for at least 10 min before starting the voltage clamp run. Repeat runs in the same drug-containing solution demonstrated that the effect of epinephrine on i_{K_2} is steadily maintained as long as the drug is present.

A cumulative-dose method was employed to study the concentration dependence of the epinephrine effect. After the initial control run, successive test runs studied the progressively higher doses of epinephrine. After the highest dose, the drug was washed out (usually over a 40-min period), and a final control run was carried out. This procedure required only one washout period, and allowed a larger amount of information to be gleaned from an individual experiment. The results of the initial and final controls generally agreed to within a few millivolts, and were averaged for the analysis. In some experiments, the preparation deteriorated during the long washout period before the final control had been completed, and in these cases only the initial control results were used.

Voltage drift is the most obvious source of error in the experiments, and would be directly reflected in the measured voltage shifts. Since the electronic devices gave little drift over the period of the experiments, the most serious source is the tip of the voltage-measuring microelectrode. The present experiments were carried out with continuous voltage microelectrode impalements. Some indication of the amount of drift was given by the potential recorded upon withdrawing the microelectrode at the end of the experiment. This value agreed with the initial level within a few millivolts and the polarity of the deviation did not appear systematic. Another index of the amount of voltage drift was the "threshold" for the excitatory sodium current, since the inactivation curve of i_{Na} is not shifted by epinephrine (Trautwein and Schmidt, 1960), and it turns out that the threshold for its activation is also unaffected. The threshold level, V_{NaT} , was determined within 1 mV by step depolarizations from the holding potential. V_{NaT} was operationally defined by the appearance of a clear-cut inward current surge on the pen recorder tracing of membrane current.

Another possible source of error was voltage nonuniformity arising from the structure of Purkinje fibers (Sommer and Johnson, 1968) and the inherent limitations of the two-microelectrode method (Deck et al. (1964); McAllister and Noble, 1966; Johnson and Lieberman, 1971). Problems of spatial and temporal nonuniformity make it impossible to characterize large, rapidly changing inward currents like i_{Na} . But these difficulties are much less serious in the case of a small, slowly changing outward current such as i_{K_2} , where the degree of nonuniformity should be small (see Tsien, 1970; Mobley and Page, 1972). The possibility of an increase in nonuniformity in epinephrine-containing solutions is considered in Results.

RESULTS

The time-dependent current changes which generate the pacemaker depolarization can be studied by applying the voltage clamp technique. Fig. 2 illustrates the effect of epinephrine on pacemaker activity and the slow current changes underlying the acceleratory action. The top panel shows a pen recording of normal electrical activity in 4 mM $[K]_o$, where the preparations typi-

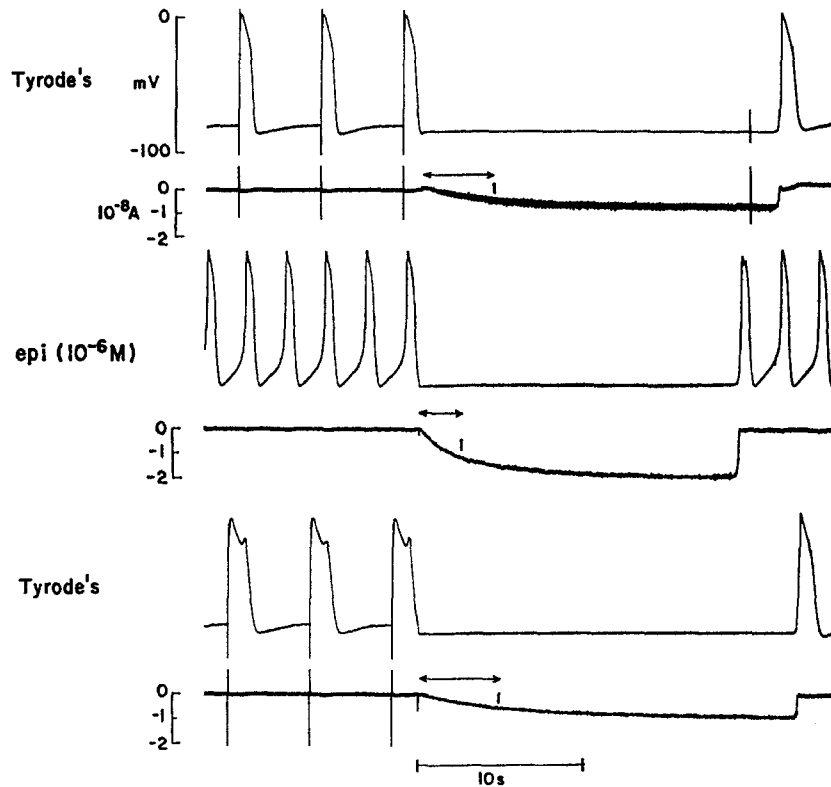

FIGURE 2. Effect of epinephrine on the slow current change which underlies pacemaker depolarization. Pen recorder tracings of intracellular potential and transmembrane current from a preparation before, during, and after exposure to 10^{-6} M epinephrine. The preparation is externally stimulated in the drug-free runs (vertical bars on current trace are shock artifacts). In each panel, voltage clamp control was initiated at the beginning of the diastolic depolarization (left arrow). This produced a slow onset of net inward current. The exponential time constant of the slow current change is indicated by the horizontal line and vertical bar. Preparation 86-3 in 5.4 mM $[Ca]_o$.

cally showed some diastolic depolarization but not spontaneous activity. After three action potentials (stimulated at 0.2 Hz) the voltage clamp circuit is turned on just at the termination of the action potential repolarization (cf. Peper and Trautwein, 1969). A slowly developing net inward current appears in the current record; this would have generated a diastolic depolarization were it not for the voltage clamp circuit. The increase in net inward current is produced by the decay of outward i_{K_2} , which unmasks a time-independent inward background current. The identification of the slow current change with a potassium component is established by experiments where the polarity of the slow current change is reversed by stepping the membrane potential to values negative to E_K (Vassalle, 1966; Noble and Tsien, 1968; Peper and

Trautwein, 1969). The agreement of the reversal potential values and the calculated E_K in various $[K]_o$ (Noble and Tsien, 1968; Peper and Trautwein, 1969) indicates that the slow current changes are due to the time dependence of a potassium channel.

The middle panel shows the effect of exposing the same preparation to epinephrine (10^{-6} M) for several minutes. The fiber now shows spontaneous activity. In this case, application of the voltage clamp at the maximum diastolic potential produces a more rapid onset of net inward current, and a larger amount of inward current in the steady state. Presuming that the inward background current is unchanged (see below) this experiment would indicate that epinephrine causes a more rapid and more complete deactivation of i_K . This effect is appropriate, of course, to the increased rate of diastolic depolarization and the appearance of spontaneous activity.

The lower panel shows that the effect of epinephrine is fully reversible upon removal of the drug; the spontaneous activity is no longer apparent and the diastolic current is restored to its original behavior.

Further information can be obtained by extending this protocol to study the current changes over the entire range of potentials where the pacemaker depolarization takes place. Fig. 3 shows such an experiment, in a short Purkinje preparation that has become partially depolarized as a result of the microelectrode impalements. The partially depolarized condition is no handicap in this context; the normal diastolic potential can be readily restored by a small hyperpolarizing current, and a typical diastolic depolarization can be observed after a stimulated action potential (left panels). During the voltage clamp procedure, the membrane potential is held at a level positive to the pacemaker range. From this "holding potential," hyperpolarizing pulses step the potential to various levels within the pacemaker range. The clamp steps are shown in the left panels, and the corresponding current changes are superimposed on the right side. The time constant of the current change (marked by vertical bar) becomes shorter as the clamp level becomes more negative. Comparison of the top right and middle right panels shows that epinephrine alters the slow current changes at *all* potentials within the range where the pacemaker activity occurs. Once again the drug effect is fully reversible (bottom panels).

These experimental results can be expressed in terms of the exponential rate of decay. Fig. 4 shows that the rate constant is steeply dependent on potential in both control and drug-containing solutions. While a low concentration of epinephrine (10^{-8} M) has no apparent effect, the higher dose (10^{-6} M) increases the rate constant two- to threefold at any given potential.

This result could be due to an overall increase in rate or a voltage shift of the rate constant function. It is important to distinguish between these possibilities since each suggests a different mechanism of action. The effect might be comparable on one hand to an increase in temperature, and on the other hand,

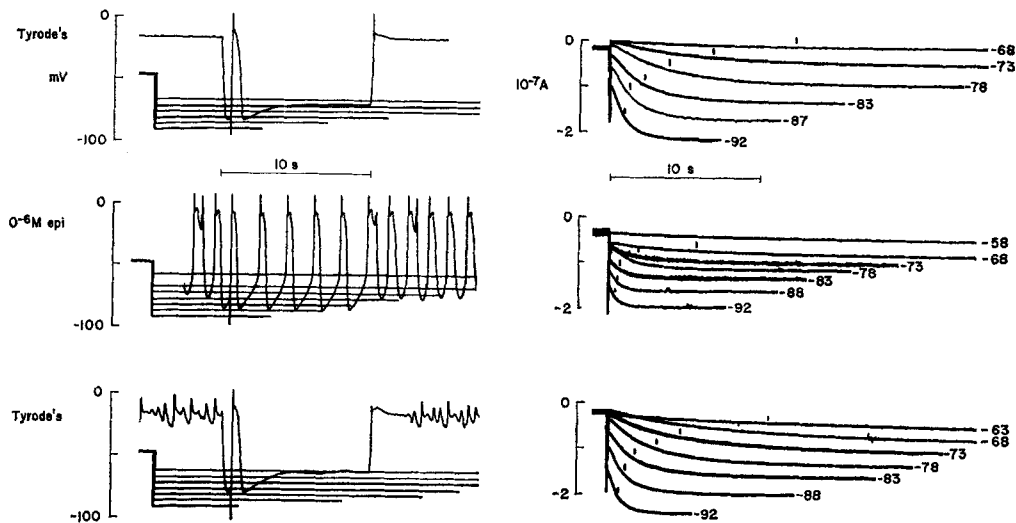

FIGURE 3. Effect of epinephrine on slow current changes over the pacemaker range of potentials. Voltage tracings (left panels) show superimposed chart-recordings of a series of hyperpolarizing voltage clamp steps, and the corresponding membrane current records are given in the right-hand panels. With each family of current records, the time constant of the decay of i_{K_2} (marked by vertical bars) became briefer as the hyperpolarizing step level (indicated in millivolts) became more negative. The left panels also show the electrical activity in this partially depolarized preparation. Epinephrine evoked low voltage oscillations due to its action on plateau currents (see Tsien et al., 1972) which largely disappeared after removing the drug. To examine activity in the normal pacemaker range of potentials the membrane was hyperpolarized in each case by a 10-s current pulse (not shown) to restore full excitability. An external stimulus then gave an action potential (overshoot $> +20$ mV, not registered on chart recording) and typical diastolic pacemaker activity for Tyrode's and epinephrine-containing solutions. Preparation 71-4, 5.4 mM $[Ca]_o$.

to the action of Ca^{++} ions (Frankenhaeuser and Hodgkin, 1957). Since the rate constant function is U-shaped (Noble and Tsien, 1968), the alternatives can be distinguished by comparing the curves at more positive potentials.

Over the range of potentials approaching the plateau the rate constant for the pacemaker current can be determined by the procedure illustrated in Fig. 5 (inset). The rate of activation is not easy to obtain from current records *during* depolarizing pulses because of interference from other current components which become activated with stronger depolarizations. However, the depolarizing clamp pulse (in this case, to -54 mV) is followed by a tail of i_{K_2} (at -80 mV) which is relatively free from other components (see Hauswirth et al. 1972). The amplitude of this tail (or the absolute level of the tail peak) is an index of the degree of activation which occurred during the depolarizing clamp pulse (Noble and Tsien, 1968).

Fig. 5 shows the result of this method, and demonstrates that epinephrine

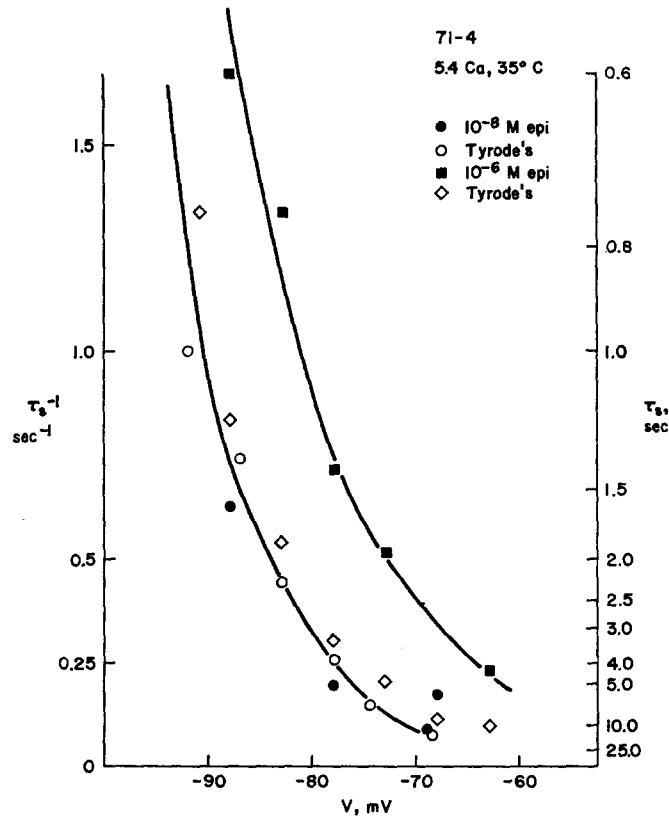

FIGURE 4. Voltage dependence of the i_{K_2} rate constant, and the effect of epinephrine. Results were obtained from the records shown in Fig. 3, as well as an earlier run in 10^{-8} M epinephrine. Smooth curves drawn by eye through the points. In this experiment $\Delta V_\beta \approx 6$ mV for $\beta_s = \beta'_s = 0.5$ s $^{-1}$.

slows the onset of i_{K_2} at -54 mV. The envelope of tails is fitted by an exponential whose time constant in the drug solution is more than three times slower in Tyrode's. This epinephrine-dependent slowing contrasts with the increase in rate in the diastolic potential range, in accord with the idea that epinephrine acts by producing a voltage shift, and not by speeding the kinetics at all potentials.

The nature and extent of the voltage shift may also be illustrated by considering the *steady-state* properties of i_{K_2} . Fig. 6 shows a steady-state activation curve (Noble and Tsien, 1968) from the same experimental preparation. Here, long clamp steps (30–40 s) were used to activate or deactivate the i_{K_2} tail at -80 mV (ordinate). The data in Tyrode's solution (open symbols) shows that i_{K_2} is about half activated at -80 mV in the steady state. Depolarization to -54 mV or beyond gives full activation; hyperpolarization to very negative potentials (below -90 mV) produces full deactivation. The level of inward

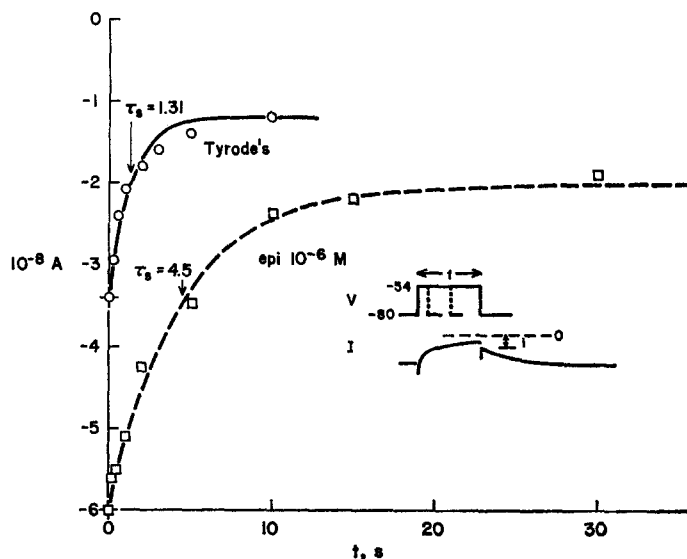

FIGURE 5. Effect of epinephrine on the rate of onset of i_{K_2} at -54 mV. The onset time constant was determined by following the development of the i_{K_2} tail current at -80 mV, as a function of the duration (t) of the preceding depolarization to -54 mV (see inset). The vertical scale gives the *level* of the peak tail current (inset). The development of the tail amplitude is thus seen on top of a base line, the steady-state current at -80 mV. This changes from -3.5 to -6.0×10^{-8} A under the influence of the drug (see also Fig. 6 a). The curves are exponentials with time constants as indicated.

current at the bottom of the activation curve corresponds to fully unmasked inward background current.

In the presence of epinephrine (10^{-6} M) the steady-state activation curve is quite different. Now i_{K_2} is fully deactivated at the -80 mV holding potential, and stronger depolarizations are required to activate i_{K_2} . This means that, at any given potential level between -90 and -55 mV, there is a smaller fraction of i_{K_2} activated in the steady state, and, therefore, a greater tendency for a diastolic depolarization (see also Fig. 2).

Is the modification of i_{K_2} the only important factor in the pacemaker action of the sympathetic hormone? Fig. 6 shows that two leading possibilities can be ruled out. First, the "sodium threshold" (V_{NaT} : see Methods) is not appreciably altered by exposure to epinephrine, in good agreement with earlier observations which show that the sodium inactivation curve (h_∞) is unaffected (Trautwein and Schmidt, 1960; Kassebaum, 1964). Second, the background current (the level of current at the bottom of the i_{K_2} activation curve) is also relatively unchanged; this was a general finding. It appears, therefore, that the modification of i_{K_2} is the *only* action of epinephrine in accelerating the pacemaker depolarization.

Can the Effect Be Described as a Simple Voltage Shift?

Up to this point, the present results are in good agreement with the preliminary report of Hauswirth et al. (1968). These authors summarized the effect of epinephrine as a simple shift in the voltage dependence of the kinetics of i_{K_2} . The existence of a straightforward voltage shift would be appealing because it would strongly suggest that the mechanism of action involves a modification of the local electric field near the i_{K_2} channel. Calcium and other multivalent ions produce voltage shifts in a variety of excitable tissues (Weidmann, 1955 *b*; Frankenhaeuser and Hodgkin, 1957) and the prevailing interpretation (cf. Moore and Jakobsson, 1971) is that these effects depend upon a change in the membrane's external surface potential. Since calcium ions also produce a voltage shift in i_{K_2} (Noble and Tsien, unpublished; Brown, 1974) the finding of a simple voltage shift in the epinephrine experiments would argue that in this case a change in surface potential might be involved (Hauswirth et al., 1968).

In view of the surface potential hypothesis, it is worth considering whether or not the present results can be entirely described by a simple displacement in the kinetic parameters of i_{K_2} . My experiments indicate that this is not the case. One aspect of the evidence appears in Fig. 6 (bottom) which plots the i_{K_2} time constant (the results in Fig. 5 appear as the data points at -54 mV). The data is represented as a time constant, rather than its reciprocal, in order to clearly illustrate the fact that the maximal value of time constant is *increased* by epinephrine. This behavior is typically observed (see Table I) and it was present in the preliminary experiments of Hauswirth et al. although much less obvious because a rate constant plot was shown (see Fig. 3 of Hauswirth et al. 1968). The slowing of the maximum time constant seen here is *not* generally found in cases where voltage shifts occur: Ehrenstein and Gilbert (1973) found only a simple voltage shift for τ_n with increases in $[Ca]_o$ in squid giant axon.

Apart from increasing the maximum time constant, epinephrine also alters the *shape* of the time constant curve in Fig. 6 (bottom). This point is more clearly illustrated in Fig. 7, which shows the results from Fig. 6 and another experiment where the data was rather complete. In these cases the experimental information is given in the form of α_s and β_s , the Hodgkin-Huxley-type rate coefficients for i_{K_2} (Noble and Tsien, 1968). However, the inherent experimental content is no different than that provided by the time constant ($\tau_s = (\alpha_s + \beta_s)^{-1}$), together with the steady-state degree of activation ($s_\infty = \alpha_s/(\alpha_s + \beta_s)$), as given in the previous figure. Plotting the rate coefficients is convenient because these are perhaps more immediately related to energy barrier models of the activation process (see Discussion). In both panels of Fig. 7 it is apparent that the deactivation rate coefficient, β_s , is shifted to a lesser degree than α_s . This finding was consistent in all experiments (Table I;

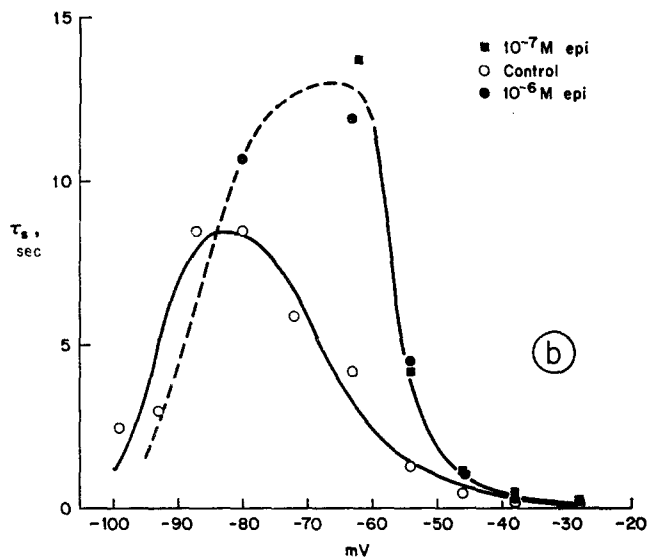
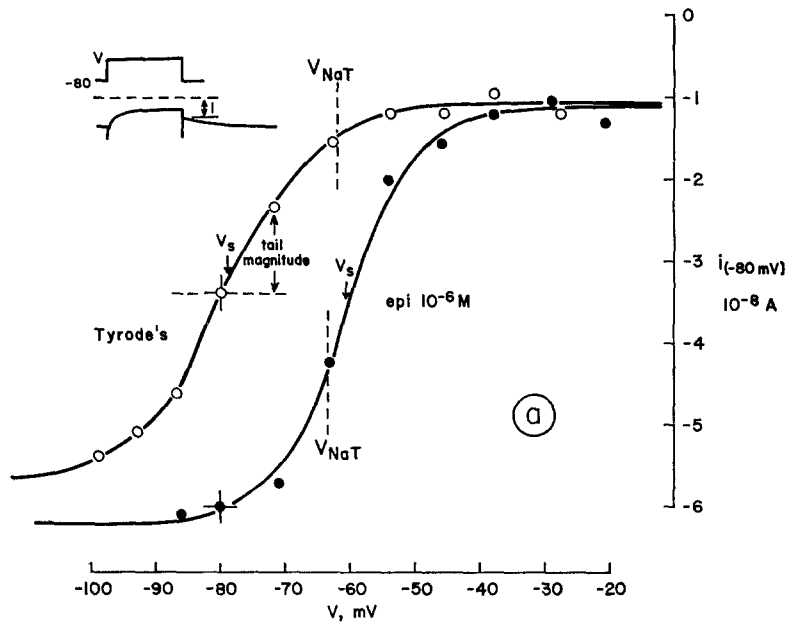

FIGURE 6. (a) Effect of epinephrine on the steady-state activation curve. As the inset indicates, the potential is stepped to a test level (V) for some 30–40 s. The degree of activation at V is then determined by measuring the tail current after return to the holding potential (-80 mV). (Tail currents are extrapolated back to the time of return to -80 mV to avoid interference from transient inward current components.) As in Fig. 5, the vertical scale gives the level of the tail current peak, but information on the tail magnitude and the steady-state current at the holding potential is retained. In the presence of epinephrine, the tail current level becomes more inward for all V between -90 and -50 mV. The midpoint of the activation curve (V_s) is shifted in the depolarizing direction. V_{NaT} is the operationally defined sodium current threshold (see Methods) and is hardly changed. Outside the range over which activation occurs, the saturating current levels approximately coincide; the magnitude of the activated current and the underlying background current are relatively unaffected. (b) Effect of epinephrine on the time constant of i_{K_2} at various potentials. Includes the results of Fig. 5, at -54 mV. In the epinephrine-containing solutions the data is incomplete in the negative range of potentials (dashed curve shows result expected from other experiments). It is evident, however, that the maximal time constant is increased by the drug. The results in Figs. 5, 6, and 7 a are from preparation 57-3, in 1.8 mM $[Ca]_o$.

TABLE I
EPINEPHRINE'S EFFECTS ON i_{K_2} : DEVIATIONS FROM
SIMPLE VOLTAGE SHIFT BEHAVIOR

Preparation	[Ca ⁺⁺] _o	Voltage shifts			(τ _s) _{max}			1/k, steepness			
		$\overline{\Delta V_s}$	$\overline{\Delta V_\beta}$	Ratio, $\frac{\overline{\Delta V_s}}{\overline{\Delta V_\beta}}$	Control	epi	Ratio control/ epi	Control	epi	Ratio control/ epi	
	mM		mV			s			mV ⁻¹		
57-3	1.8	19.0	~7	2.71	8.5	12.8	1.51	0.125	0.229	1.83	
71-4	5.4	—	9	—	—	—	—	—	—	—	
75-1	5.4	18.0	6.0	3.0	—	—	—	0.151	0.242	1.61	
87-4	5.4	26.5	12.5	2.12	4.6	8.0	1.74	0.178	0.308	1.73	
93-6	1.8	17.3	7.5	2.31	4.2	7.0	1.67	0.154	0.223	1.45	
94-1	5.4	16.5	—	—	4.2	>5	—	0.225	0.125	0.55	
94-11	5.4	23.0	12	1.92	3.9	6.7	1.72	0.174	0.242	1.39	
90-3	5.4	—	—	—	—	—	—	0.136	0.255*	1.88	
90-7	5.4	{	7.7*	—	—	—	—	0.141	{	0.296*	{
92-8	5.4	18.7‡	—	—	—	—	—	0.205‡	0.364‡	1.77	
Average:		18.3		2.42			1.66			1.59	

Columns headed by the label "epi" show results obtained in 10⁻⁶ M or 10⁻⁵ epinephrine bitartrate. ΔV_s is the depolarizing voltage shift of the steady-state activation curve ($\Delta V_s \cong \Delta V_\alpha$). ΔV_β is the depolarizing voltage shift of β . This was measured at a level of $\beta_s = \beta_\infty = 0.5 \text{ s}^{-1}$ (except in 94-11 and 57-3; see Fig. 7). The parameter k applies to the equation $(1 + \exp(V_s - V)/k)^{-1}$ which may be used to fit the activation curve. k was usually obtained by measuring the maximum slope of the activation curve and setting that value equal to 1/4 k .

* indicates the presence of both inward current inhibitors, D600 (5×10^{-7} g/ml) and TTX (10^{-6} g/ml).

‡ indicates the presence of D600 (5×10^{-7} g/ml) only.

compare Fig. 4 and Fig. 6 bottom). Once again, the simple voltage shift concept does not adequately describe the results. A possible explanation of these deviations from simple voltage shift behavior is given in the Discussion.

Epinephrine Changes the Steepness of the Activation Curve

It is apparent in Fig. 7 (top) that the *steepness* of the voltage dependence of the activation rate coefficient, α_s , may be increased by epinephrine. There is also an associated steepening in the steady-state activation curve (Fig. 6, top). A particularly dramatic example of this steepening effect is shown in Fig. 8 (top). In this experiment, the activation curve is steepened twofold. Steepening occurred in eight out of nine experiments (see Table I) but generally to a more modest extent than in this particular case.

The steepening effect has some precedent in action of calcium ions in nerve membrane. Frankenhaeuser and Hodgkin (1957) and Moore and Jakobsson (1971) found that the steepness of the sodium inactivation curve (h_∞) increases

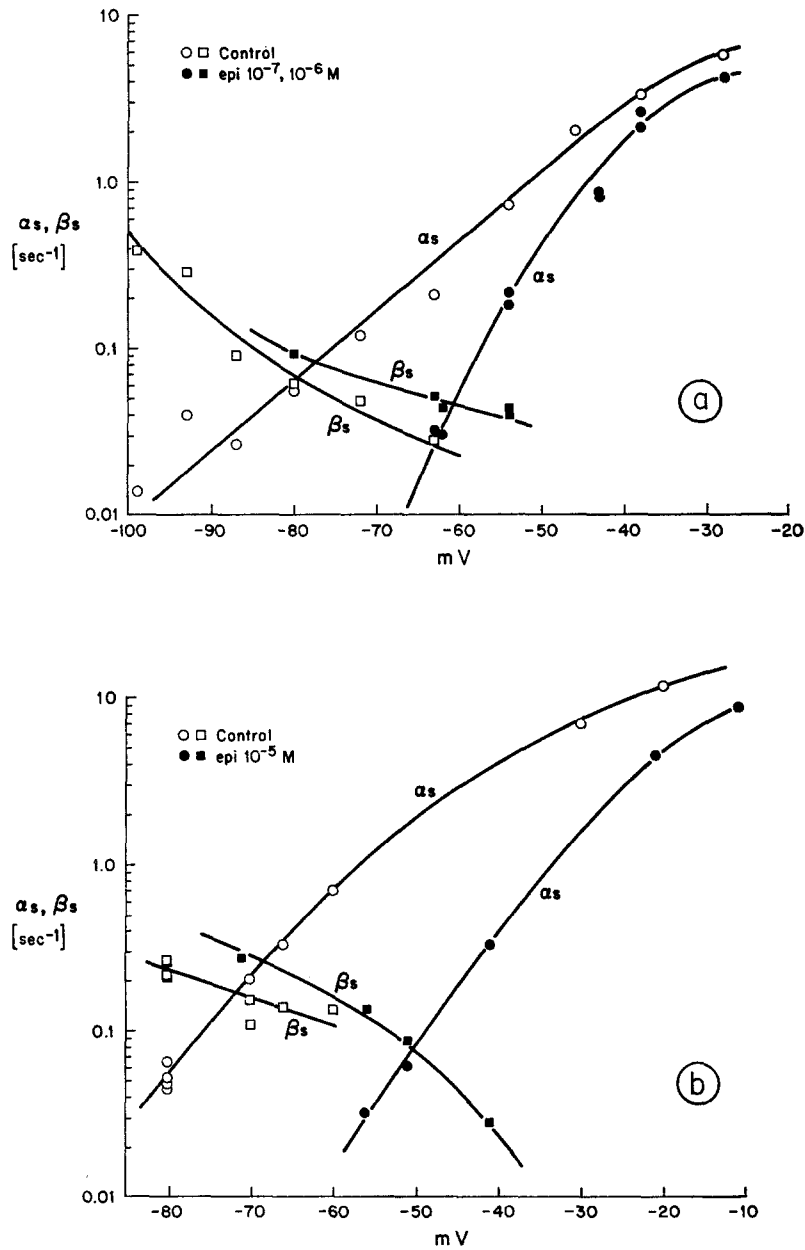

FIGURE 7. Effect of epinephrine on the rate coefficients of i_{K_2} : α_s (circles) and β_s (squares). Control results (open symbols) are compared with data in epinephrine-containing solution (filled symbols). Top experiment 57-3 (points were calculated from data in Fig. 6: see text). Bottom, experiment 94-11. Smooth curves drawn by eye. Despite differences in detail, both experiments show that ΔV_α is considerably larger than ΔV_β . Over the diastolic range of potentials, the rate coefficient curves are approximately linear in this semi-log plot, but α_s appears to saturate with strong depolarizations, possibly indicating that a voltage-insensitive process becomes rate limiting (see Tsien and Noble, 1969).

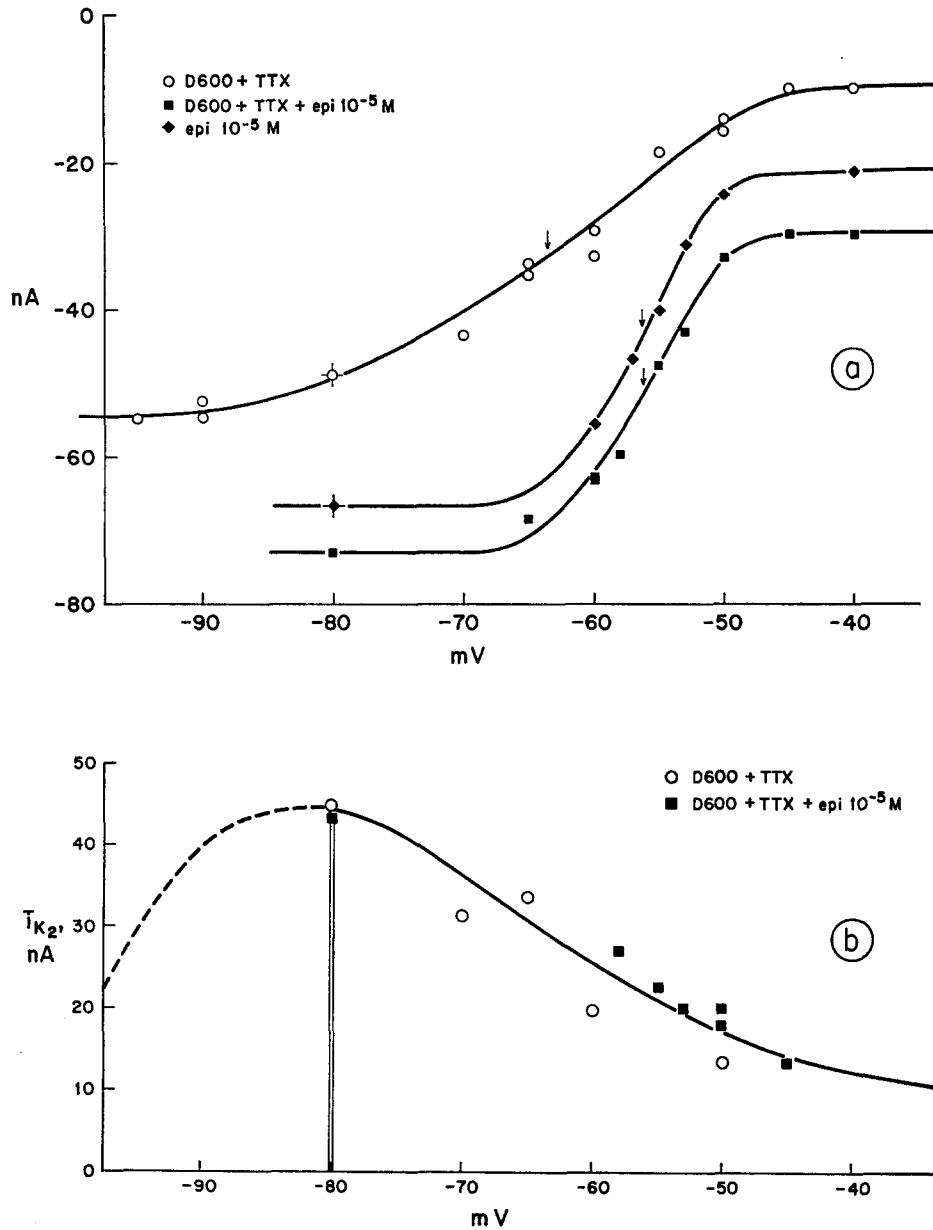

FIGURE 8. (a) Effect of epinephrine on the steepness of the i_{K_2} activation curve. Preparation 90-7, 5.4 mM $[Ca]_o$. Experimental analysis similar to that in Fig. 6 A. Open circles give the control activation curve, in the presence of D600 (5×10^{-7} g/ml) and TTX (10^{-6} g/ml). Filled symbols show the effect of 10^{-5} M epinephrine, (■) in the maintained presence of D600 + TTX, and (◆) after washing out the inward current inhibitors. There is marked steepening of the activation curve, independent of the presence or absence of D600 (which largely and reversibly blocked the secondary inward current in this experiment). Unlike Fig. 6 A, there is a shift in background current level which may be attributed to a progressive increase in inward leakage current. (b) The inward rectifier characteristic of i_{K_2} is unaffected by epinephrine. Ordinate plots the magnitude of the fully activated current (\bar{i}_{K_2}). Values of $(\bar{i}_{K_2})_{-80}$ (vertical lines) were obtained from the amplitudes of the corresponding activation curves (8 a). Points at other test potentials (abscissa) are determined by measuring the ratio (slow current onset at V)/(slow current decay at -80 mV) and scaling by $(\bar{i}_{K_2})_{-80}$. (For explanation of this approach see Noble and Tsien 1968). Dashed curve shows shape of rectifier curve expected from other experiments on i_{K_2} .

as $[Ca]_o$ is elevated. Before accepting the present results at face value, however, it is reasonable to ask whether the epinephrine effect is merely an artifact. The "steepening" of an activation curve sometimes indicates that voltage control has become increasingly inadequate (see Johnson and Lieberman, 1971; Jack et al., 1974) so that a large regenerative inward current is poorly controlled. This possibility is particularly serious in these experiments because (a) the shift in i_{K_2} kinetics brings the activation curve into the potential range over which the secondary inward current also becomes activated (Carmeliet and Vereecke, 1969; Vitek and Trautwein, 1971) and (b) epinephrine is known to increase the magnitude of the secondary inward current in Purkinje fibers (Carmeliet and Vereecke, 1969).

The question of a possible lack of voltage control due to these factors may be approached by using pharmacological inhibitors to block the secondary inward current. Organic compounds, in particular verapamil and its methoxy-derivative, D600 (Kohlhardt et al., 1972) are especially helpful in this context; unlike Mn^{+++} and La^{++} , the organic blockers do not affect the diastolic depolarization or the kinetics of i_{K_2} . As in ventricular muscle (Kohlhardt et al., 1972), D600 suppresses contraction as well as secondary inward current in Purkinje fibers, in a rapid and reversible manner (unpublished observations). Fig. 8 *a* illustrates the fact that blocking the secondary inward current does not prevent the activation curve from becoming more steep in the presence of epinephrine. In this experiment, the control run and the exposure to the catecholamine was carried out in the presence of D600 (which abolished the low voltage oscillations generated by the secondary inward current), and also tetrodotoxin. Not only did the steepening occur with the addition of epinephrine, but it also remained unchanged even after the inward current inhibitors had been removed and after the secondary inward current was restored. Similar results were obtained in two other experiments using D600 (Table I). It is highly unlikely, therefore, that the steepening effect is explained by a loss of voltage control due to the secondary inward current.

This experiment also suggests that the effect of epinephrine on i_{K_2} is not subsidiary to an increase in calcium entry due to augmentation of the secondary inward current (see *Concentration Dependence of the Voltage Shift*, below).

Inward Rectifier Properties of i_{K_2} Are Unaffected by Epinephrine

Previous experiments have shown that i_{K_2} channels have the property of inward-going rectification. The current-voltage relationship of the open (i.e. fully activated) i_{K_2} channels has been designated \bar{i}_{K_2} (Noble and Tsien, 1968). The voltage dependence of \bar{i}_{K_2} is rather striking, and included a region of negative slope between -70 mV and the plateau range of potentials (Hauswirth et al. 1972). Although the mechanism of inward rectification is not well understood (see Adrian, 1969), it seems likely that the rectifier characteristic

corresponds to some voltage-sensitive process which decreases the channel's permeability as the membrane is increasingly depolarized (Armstrong and Binstock, 1965; Grundfest, 1966; Horowicz et al. 1968). Since epinephrine has a large effect on the voltage sensitivity of the activation gates, one might expect that the catecholamine would also modify the voltage sensitivity of inward-going rectification in this system.

Fig. 8 (bottom) compares inward rectifier characteristics obtained in Tyrode's solution, and in epinephrine solution, in the maintained presence of tetrodotoxin and D600. The method of analysis is explained elsewhere (Noble and Tsien, 1968; Tsien, 1970) but a brief description may be given here. The vertical lines are the fully activated i_{K_2} current (\bar{i}_{K_2}) at -80 mV. These values are directly obtained as the amplitude of the activation curves in Fig. 8 (top). These values are very reliable since many data points contribute, and it is clear that no change in the magnitude of \bar{i}_{K_2} (-80 mV) takes place. The points at other potentials are obtained by taking the ratio of the magnitudes of the slow current onset during a voltage step and the slow current tail after return to the holding potential. Each ratio is scaled by the magnitude of \bar{i}_{K_2} at -80 mV to give the current magnitude at voltage levels other than -80 mV. This method is valid even though the activation curve is shifted, but it assumes that the entire slow current onset is due to i_{K_2} , and is dependent, therefore, on the lack of interference from other time-dependent components.

The results show that epinephrine does not alter the inward rectifier characteristic over the range where pacemaker activity occurs. There is no change in the negative slope behavior of the \bar{i}_{K_2} curve in contrast to the clear-cut effect on the voltage-dependent activation. The lack of effect on \bar{i}_{K_2} has functional significance, since the property of inward rectification plays a role in the generation of the pacemaker depolarization (Noble and Tsien, 1968; McAllister et al.).¹ The absence of a shift in \bar{i}_{K_2} is also interesting in providing evidence that activation and inward rectification are controlled by functionally distinct processes (Noble and Tsien, 1968; Tsien and Noble, 1969). This distinction was previously suggested by the fact that changes in $[K]_o$ shifted the \bar{i}_{K_2} characteristic *without* modifying the location of the activation curve (Noble and Tsien, 1968). In a sense, therefore, potassium ions and epinephrine have non-overlapping actions on i_{K_2} . The independence of inward rectification and Hodgkin-Huxley-type activation can most easily be explained if activation is a quantal process at the level of the single channel.

Modification of i_{K_2} May Be Classified as a β -Adrenergic Effect

Most of the actions of catecholamines in heart may be classified as β -adrenergic effects but it is now clear that α -adrenergic effects also exist. Purkinje fibers

¹ McAllister, R. E., D. Noble, and R. W. Tsien. 1974. Reconstruction of the electrical activity of cardiac Purkinje fibres. Submitted to *J. Physiol. (Lond.)*.

themselves exhibit α -adrenergic sensitivity (Giotti et al., 1973; Cranefield et al., 1971). It is important, therefore, to determine the nature of the effect of epinephrine on i_{K_1} .

Isoproterenol is a relatively pure β -agonist. I find that isoproterenol has an epinephrine-like effect on the kinetics of i_{K_2} , in good agreement with its previously known acceleratory action (Kassebaum and Van Dyke, 1966). Furthermore, preexposure to the β -blocker *l*-propranolol (10^{-6} M) abolishes the voltage shift that would normally be produced by epinephrine (10^{-7} M). Propranolol alone produces no voltage shift in either direction. These experiments reinforce the view that propranolol has a genuine effect as a β -blocker in Purkinje fibers, an action which is distinct from its local anaesthetic action on the fast sodium current at higher concentrations (Davis and Temte, 1968).

The α -agonist phenylephrine (10^{-6} M) had no detectable effect on i_{K_1} in the presence of 10^{-6} M propranolol (single experiment). Gelles et al.² have examined the action of dopamine on i_{K_2} and have observed an epinephrine-like effect. Although dopamine sometimes produces α -adrenergic effects, Gelles et al. were able to block its effect with propranolol so that it seems safe to conclude that dopamine produced its action through its interaction with β -receptors.

Variability in the Properties of i_{K_2}

The remainder of this paper, and the following paper are concerned with the sensitivity of i_{K_2} to a variety of chronotropic agents. In studying the effects of pharmacological agents on this component, it is convenient to use the location of the activation curve as an index of the overall effect. This can be represented by V_s , the potential required for half activation in the steady state.

The values of V_s in Tyrode's solution showed considerable variability from preparation to preparation. Such variations are important, not only for pharmacological studies, but also for reconstructing pacemaker activity (McAllister et al.).¹ Table II gives values for V_s , as well as values for the "sodium threshold," V_{NaT} (see Methods), and for the maximum diastolic potential, V_{MDF} . The variability in V_{NaT} is comparable to Weidmann's (1955 *b*) range of values for the location of the sodium inactivation curve (V_h fell between extremes of -84 and -60 mV) and for the threshold for a regenerative response to depolarizing current pulses (between extremes of -76 and -60 mV). The present experiments show a definite correlation between V_{NaT} and V_s . This could be interpreted in terms of a general membrane surface potential, varying from one preparation to another. But it also could be explained if there were large tip potential artifacts. Although this possibility is difficult to rule

² Gelles, J. M., R. S. Aronson, and B. F. Hoffman. Voltage clamp analysis of the effects of dopamine on the transmembrane ionic currents underlying the action potential in sheep cardiac Purkinje fibers. Submitted for publication.

TABLE II
VOLTAGE PARAMETERS RELEVANT TO PACEMAKER ACTIVITY

Preparation	V_{MDP}	V_{NaT}	V_s	$\overline{\Delta V_s}$
70-3	-87	-62	-65	18
75-1	-83	—	-70	18
76-5	-86	-62	-72.5	—
76-6	-87	-60	-72.5	—
77-1	-87	-60	-68	—
81-2	-69	-44	-57	18
81-3	-66	-44	-48	8
83-3	-72	-46	-57	—
83-7	-87	-51	-60	—
84-2	-83	-48	-53.5	—
86-2	(-20)	-63	-71.5	—
87-2	-83	-56	-67.2	—
87-4	-85	-62	-72.5	26.5
87-5	-82	<-56	-56.5	—
90-1	-82	<-52	-68.2	—
90-3	-70	-55	-62	14*
90-7	-86	—	-63.5*	7.7* 7.3
92-6	(-17)	-55	-69.4	—
92-8	(-26)	-60	-75.7‡	18.7‡
94-1	-68	-59	-72.8‡	16.5‡
94-8	(-32)	-62	-71.5	—
94-11	(-25)	<-60	-72.2	23.0
Mean \pm SE		-55.8 \pm 6.5	-65.8 \pm 7.4	

Results from experiments in 5.4 mM $[\text{Ca}]_o$, in millivolts. V_{MDP} is maximum diastolic potential following the action potential repolarization, usually at the beginning of the experiment. (The value of V_{MDP} at the end of a typical experiment not used because of a slow progressive increase in leakage current over several hours of voltage clamping.) Values in parenthesis indicate preparations in a partially depolarized condition. V_{NaT} , V_s and ΔV_s are defined in the text. ΔV_s was determined for either 10^{-6} or 10^{-5} M epinephrine. (*) and (‡) are defined in Table I.

out entirely, it is probably not the major explanation of the variability in V_s or V_{NaT} . This can be seen from the much poorer correlation between either of these parameters, and V_{MDP} . Preparation 84-2 provides a specific example. V_{MDP} is reasonably negative: -83 mV is a typical value for fibers in 4 mM $[\text{K}]_o$. However, the value of V_s , -53.5 mV, is quite depolarized. Since both measurements are made during the course of a single continuous microelectrode impalement, and nearly always within a period of 20 min, it is difficult to argue that the value of V_s is spurious without also stating that the value of V_{MDP} is similarly incorrect. If V_s were "corrected" for the hypothetical voltage artifact, to a more typical value, -70 mV, V_{MDP} would likewise be corrected to -99.5 mV, which is quite unrealistic in 4 mM $[\text{K}]_o$.

In addition to the variability in V_s , considerable variability was also observed in the magnitude of the maximal voltage shift, $\overline{\Delta V_s}$, obtained with a high

concentration of epinephrine (usually 10^{-5} M). Although the maximal voltage shift was typically about 20 mV, it was sometimes as small as 8 mV. There was no obvious correlation between the observation of a small $\overline{\Delta V_s}$ and a V_s less negative than usual in the absence of epinephrine (see Table II).

Whatever the explanation, the variability in both V_s and $\overline{\Delta V_s}$ makes it difficult to express the results of pharmacological experiments in terms of absolute membrane potential. It seems more reasonable to use each preparation as its own control (see Methods). In a given experiment a continuous voltage impalement was used in determining V_s in a sequence of solutions with different drug concentrations. The V_s values were used to determine the voltage shift, ΔV_s , in each solution, relative to drug-free Tyrode's. The ΔV_s values were then normalized by the maximal shift, $\overline{\Delta V_s}$, which was obtained by a high concentration of epinephrine, usually 10^{-5} M, but occasionally 10^{-6} M.

Concentration Dependence of the Voltage Shift

Fig. 9 shows results from six experiments where the normalized voltage shift ($\Delta V_s/\overline{\Delta V_s}$) was determined in various concentrations of epinephrine. The sensitivity to epinephrine is similar in solutions containing 1.8 mM $[Ca]_o$ (open symbols) and 5.4 mM $[Ca]_o$ (closed symbols), despite the fact that calcium ions also produce voltage shifts in i_{K_2} (Noble and Tsien, unpublished; Brown, 1974). The direct effect of elevating the calcium concentration does not appear in Fig. 9 because of the normalization procedure. The actions of epinephrine

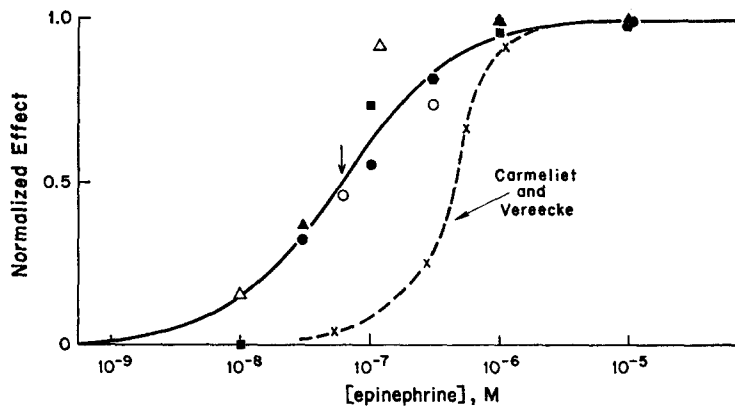

FIGURE 9. Normalized dose-response curve for the epinephrine voltage shift. $\Delta V_s/\overline{\Delta V_s}$ vs. log epinephrine concentration from seven experiments in 1.8 mM $[Ca]_o$ (open symbols) and 5.4 mM $[Ca]_o$ (filled symbols). The data was fitted by eye to a one-for-one binding curve which is half maximal at 60 nM epinephrine (arrow). For comparison, the crosses and dashed curve show Carmeliet and Vereecke's (1969) dose-response relation for the effect of epinephrine on the secondary inward current in cow Purkinje fibers, in the presence of 1.8 mM $[Ca]_o$, as determined by the prolongation of the secondary depolarization.

and Ca-like ions on i_{K_2} seem to be additive, however, judging from the similar values of ΔV_s in 1.8 and 5.4 mM $[Ca]_o$ (Table I). This result seems to agree with Reuter's (1965) observations of the combined effects of epinephrine and calcium ions on pacemaker activity; the question of additivity is further pursued in Fig. 6 of the following paper.

The data is fitted reasonably well by a simple binding curve (solid curve in Fig. 9). This curve is predicted by a model for the drug action where epinephrine molecules combine with the β -adrenergic receptor in a one-to-one fashion, and where the voltage shift is directly proportional to the number of receptors occupied. Although this model is both straightforward and plausible, the following paper will present other experimental evidence which makes this explanation very unlikely.

The results show that i_{K_2} is very sensitive to epinephrine. This sensitivity may be compared to the dose dependence of spontaneous activity produced by the drug. Purkinje fibers in 4 mM $[K]_o$ typically show diastolic depolarization but without spontaneous activity. Exposure to 10^{-8} M epinephrine barely affects the diastolic depolarization; 10^{-7} M evokes rapid spontaneous activity at a rate not much lower than in 10^{-6} M epinephrine. These results will be documented in a later paper which also studies the effects of epinephrine on the action potential plateau. But it is clear that the steepest increase in pacemaker activity takes place over the concentrations between 10^{-8} M and 10^{-7} M, in general agreement with the data in Fig. 9.

The midpoint of the i_{K_2} dose-response curve lies at an epinephrine concentration of 60 nM. This value is about one order of magnitude lower than the concentration required for half-maximal effect on the secondary inward current, as shown by the crosses (from Carmeliet and Vereecke's (1969) experiments in cow Purkinje fibers). Carmeliet and Vereecke used various indirect indices of the increase in secondary inward current, but a very similar dose-response curve for norepinephrine has also been obtained by Reuter³ from direct measurements of the secondary inward current magnitude in cat papillary muscle using the double sucrose gap method. The differing epinephrine sensitivities of i_{K_2} and the secondary inward current are consistent with the fact that the pacemaker depolarization is more sensitive to catecholamines than the plateau level. Since it is possible (at 10^{-7} M epinephrine) to evoke a large fraction of the i_{K_2} voltage shift without appreciably increasing the secondary inward current, it is unlikely that the i_{K_2} effect is subsidiary to an increase in calcium influx (see also Fig. 8). Further interpretation of the different dose-response curves involves hypotheses for the mechanism of epinephrine's actions, and will be deferred to the following paper.

³ Reuter, H. 1974. Localization of β -adrenergic receptors, and effects of noradrenaline and cyclic nucleotides on action potentials, ionic currents and tension in mammalian cardiac muscle. *J. Physiol. (Lond.)*. In press.

DISCUSSION

The main conclusion of this paper is that epinephrine brings about an acceleration of pacemaker activity in Purkinje fibers through a rather selective effect on the kinetics of i_{K_2} , the pacemaker potassium current. In agreement with a preliminary report (Hauswirth et al., 1968) the change in kinetics can be described approximately as a "voltage shift," that is, a displacement of the kinetic parameters of i_{K_2} along the voltage axis toward less negative potentials.

The experiments indicate furthermore that the alteration in i_{K_2} is the sole mechanism of the positive chronotropic effect. Other factors may now be ruled out: (a) Epinephrine does not increase the magnitude of the inward background current which is progressively unmasked by i_{K_2} deactivation during pacemaker activity; (b) epinephrine does not alter the current-voltage relation of the fully activated pacemaker K current ($\overline{i_{K_2}}$), implying that the catecholamine modifies the *gating* of channels without affecting the properties of the individual channels when open; (c) epinephrine does not alter the threshold for the fast sodium current which underlies the action potential upstroke.

The last result was obtained by determining V_{NaT} , the most negative potential at which a detectable inward sodium transient appears with step depolarizations (see Methods). The constancy of V_{NaT} indicates that the voltage-dependent activation of i_{Na} (m^3) is not shifted along the voltage axis, and agrees with the observation that the inactivation process (h) is similarly unaffected (Trautwein and Schmidt, 1960). It should be mentioned, however, that Otsuka (1958) found that in spontaneously firing preparations, epinephrine altered the apparent threshold potential (judged by the disappearance of the oscilloscope trace). Otsuka's result is probably not in conflict with the present findings since the apparent threshold depends critically upon the degree of accommodation of i_{Na} which occurs during the preceding diastolic depolarization. In epinephrine-containing solution, the steep pacemaker depolarization allows less time for accommodation and presumably gives rise to a more negative apparent threshold.

Are the present results compatible with epinephrine's positive chronotropic effect? The acceleration of the pacemaker has been quantitatively reconstructed in computer calculations which incorporate the voltage shift in i_{K_2} kinetics (McAllister et al.).¹ In the reconstructed activity, a very large speeding of pacemaker depolarization can be achieved by voltage shifts of the observed magnitudes, i.e. 20–25 mV. In this regard, the voltage clamp results can successfully account for the positive chronotropic effect. There is only one obvious remaining discrepancy. In experimental recordings (Otsuka, 1958), the maximum diastolic potential becomes more negative under the influence of epi-

nephrine. The computer reconstruction does not simulate this behavior because it does not include any modification in the current generated by electrogenic sodium transport, (Vassalle, 1970; Vassalle and Barnabei, 1971; Hiroaka and Hecht, 1973). The present experiments were not designed to clarify the contribution of electrogenic pump; the voltage clamp protocol limited the rate of sodium entry and probably minimized the degree of pump activation. The absence of a noticeable change in background current (Figs. 3, 6 A) does not conflict, therefore, with the view (Vassalle and Barnabei, 1971; Carpentier and Vassalle, 1971) that the electrogenic current is increased by epinephrine during spontaneous activity.

Departures from Simple Voltage Shift Behavior

One of the surprising results was that the alteration in i_{K_2} kinetics differed significantly from simple voltage shift behavior in a number of respects. The kinetic parameters of i_{K_2} were not simply and uniformly displaced along the voltage axis: Thus, (a) Exposure to epinephrine slows the maximum time constant, $(\tau_s)_{max}$, of the exponential changes in i_{K_2} . (b) Epinephrine shifts the activation rate coefficient, α_s , more than it shifts the deactivation rate coefficient, β_s . Usually, $\Delta V_s \cong \Delta V_{\alpha\lambda} \cong 2\Delta V_\beta$. (c) Epinephrine often increases the steepness of the voltage-dependent activation curve. In each of these respects, the action of epinephrine on i_{K_2} is different from the simple voltage shift behavior exhibited by the potassium current in squid nerve when the external calcium ion concentration is increased (Ehrenstein and Gilbert, 1973).

The deviations from simple voltage shift behavior are relevant to recent hypotheses which attribute the action of epinephrine to some sort of alteration in membrane surface charge, in much the same way that Huxley (Frankenhaeuser and Hodgkin, 1957) explained the effects of calcium ions on nerve. The basic idea is that a change in surface charge alters the electric field within the membrane which is sensed by the activation reaction, without changing the measured membrane potential. Either an addition of positive charge to the external surface (Hauswirth et al., 1968) or a net removal of positive charge from the internal surface (Tsien, 1973; McNaughton and Noble, 1973) would be appropriate to produce a voltage shift toward less negative potentials. These hypotheses are discussed later (Tsien, 1974). At this point, the main question is whether the deviations from simple voltage shift behavior can be accounted for by *any* surface charge mechanism.

Previous treatments of voltage shift phenomena have described surface charge as a blurred layer (Chandler et al., 1965; Gilbert and Ehrenstein, 1969) or as a regular array of point charges whose overall effect is quite similar to that of a smeared layer (Cole, 1969). These models lead to predictions of uniform voltage shift behavior, and in most other cases this has been compatible with the experimental observations (but cf. Frankenhaeuser and Hodgkin

1957, Fig. 8; Moore and Jakobsson, 1971). In the present case, the smeared charge model seems inappropriate if only because epinephrine (unlike calcium ion) shifts the kinetics of i_{K_2} without affecting i_{Na} . If surface charge were involved, the selective nature of the epinephrine effect would argue in favor of a rather specific change in surface charge at a discrete point on the membrane surface.

If the surface charge modification were, in fact, discrete rather than smeared, would this account for the deviations from simple voltage shift behavior? This question may be answered by considering a plausible model of the gating reaction. Suppose that the opening and closing of a channel were controlled by the movements of a charged particle from one edge of the membrane to the other (cf. Hodgkin and Huxley, 1952). In the simplest case (see, e.g. Tsien and Noble, 1969), the two positions would be separated by a single energy barrier and the rate coefficients α_s and β_s would be determined by the height of the barrier as seen from the respective sides of the membrane. Since α_s and β_s depend upon opposite approaches to the energy barrier, they must in turn depend upon the electric field over *different* segments of the particle's path through the membrane. This fact is important because a discrete surface charge modification will in general produce a nonlinear change in the membrane potential profile (Brown, 1974). In principle, therefore, α_s and β_s would be altered to different extents. The quantitative details will depend, of course, on the proximity of the point charge to the channel, and the effect of screening counterions in the aqueous solution. It seems possible, however, that observations (a) and (b) might thus be explained.

A Change in the Effective Valency of the Gating Reaction?

In another respect, however, the discrete surface charge model is not sufficient to account for the experimental results. It cannot explain the third observation, the steepening of the activation curve. The activation curve is measured under "steady-state" conditions, and should therefore be governed by the total energy difference between the open and closed states. No change in the steepness of the activation curve is to be expected, even if the shape of the potential profile is altered. Within the context of the model, the change in steepness can be accounted for only if the particle's effective valency (z) were increased.

Can the various effects of epinephrine on i_{K_2} be explained entirely by a change in z ? Effects of changing z can easily be predicted using a single energy barrier model (see Tsien and Noble, 1969). The electrostatic energy difference between "open" and "closed" states is proportional to the product zV . For a given level of electrostatic energy, and hence, a specific value of α_s or β_s , a change in z (to z') can be compensated for by a change in V (to V'), where $zV = z'V'$. The typical increase in the steepness of the activation curve cor-

responds to an increase in valency from $|z| = 4$ to $|z'| = 6$. If the midpoint of the activation curve, V_s , were located at -66 mV in the control solution, (Table II) the change in valency would be accompanied by a 22-mV voltage shift, to $V'_s = -44$. Thus, the hypothetical valency change could account for the usual amount of voltage shift observed, as well as the steepening of the activation curve.

The main drawback of this explanation is that it fails to account for the other departures from simple voltage shift behavior. First, the increase in valency would not give rise to a slowing of the maximal time constant, as observed experimentally; the location of $(\tau_s)_{\max}$ would simply be shifted along the voltage axis. Second, ΔV_β would be larger than ΔV_s , since ΔV_β is measured over a more negative range of potentials. This prediction also disagrees with experimental results (Table I).

In conclusion, each of the simple mechanisms discussed above does not by itself account for all aspects of the epinephrine effect. A more unifying explanation may become possible as we gain information about membrane channels and the processes which control their permeability. Meanwhile, it is interesting to ask if simple voltage shift behavior is typical of Hodgkin-Huxley-type processes in other excitable membranes (see Ehrenstein and Gilbert, 1973). Deviation from simple behavior has already been found for sodium inactivation in squid axon (Frankenhaeuser and Hodgkin, 1957), where $h_\infty(V)$ is steepened as $[Ca]_o$ is increased (see also Moore and Jakobsson, 1971). It remains to be seen whether steepening, and other such deviations from simple behavior occur more generally in membranes where voltage shifts are observed.

I am grateful to W. K. Chandler and Roger Tsien for their helpful comments on the manuscript. This investigation was supported by U. S. Public Health Service Research Grant 5 R01 HL13306 (National Heart and Lung Institute).

Received for publication 14 February 1974.

REFERENCES

- ADRIAN, R. H. 1969. Rectification in muscle membrane. *In* Progress in Biophysics. Butler and Noble, editors. 19:341.
- ARMSTRONG, C. M., and L. BINSTOCK. 1965. Anomalous rectification in the squid giant axon injected with tetraethylammonium chloride. *J. Gen. Physiol.* 48:859.
- BROWN, R. H., JR. 1974. Membrane surface charge: discrete and uniform modelling. *Prog. Biophys. Mol. Biol.* In press.
- CARMELIET, E., and J. VEREECKE. 1969. Adrenaline and the plateau phase of the cardiac action potential. *Pfluegers Archiv. Gesamte Physiol. Menschen Tiere.* 313:303.
- CARPENTIER, R., and M. VASSALLE. 1971. Enhancement and inhibition of a frequency-activated electrogenic sodium pump in cardiac Purkinje fibers. *In* Research in physiology—a liber memorialis in honor of Dr. C. McC. Brooks. F. F. Kao, K. Koizumi, and M. Vassalle, editors. Gaggi Aulo Editore, Bologna.
- CHANDLER, W. K., A. L. HODGKIN, and H. MEVES. 1965. The effect of changing the internal

- solution on sodium inactivation and related phenomena in giant axons. *J. Physiol. (Lond.)*. 180:821.
- COLE, K. S. 1969. Zeta potential and discrete vs. uniform surface charges. *Biophys. J.* 9:465.
- CRANFIELD, P. F., B. F. HOFFMAN, and A. WIT. 1971. Block of conduction in partially depolarized cardiac Purkinje fibers induced by an α -adrenergic agent. *Nat. New Biol.* 234:159.
- DAVIS, L. D., and J. TEMTE. 1968. Effects of propranolol on the transmembrane potentials of ventricular muscle and Purkinje fibers of the dog. *Circ. Res.* 22:661.
- DECK, K. A., R. KERN, and W. TRAUTWEIN. 1964. Voltage clamp technique in mammalian cardiac fibres. *Pfluegers Archiv. Gesamte Physiol. Menschen Tiere.* 280:50.
- DECK, K. A., and W. TRAUTWEIN. 1964. Ionic currents in cardiac excitation. *Pfluegers Archiv. Gesamte Physiol. Menschen Tiere.* 280:63.
- DUDEL, J., K. PEPPER, R. RÜDEL, and W. TRAUTWEIN. 1967. The dynamic chloride component of membrane current in Purkinje fibres. *Pfluegers Archiv. Gesamte Physiol. Menschen Tiere.* 295:197.
- EHRENSTEIN, G., and D. L. GILBERT. 1973. Evidence for membrane surface charge from measurement of potassium kinetics as a function of external divalent cation concentration. *Biophys. J.* 13:495.
- FRANKENHAEUSER, B., and A. L. HODGKIN. 1957. The action of calcium on the electrical properties of squid axons. *J. Physiol. (Lond.)*. 137:217.
- GILBERT, D. L., and G. EHRENSTEIN. 1969. Effect of divalent cations on potassium conductance of squid axons: determination of surface charge. *Biophys. J.* 9:447.
- GIOTTI, A., F. LEDDA, and P. F. MANNAIONI. 1973. Effects of noradrenaline and isoprenaline, in combination with α - and β -receptor blocking substances, on the action potential of cardiac Purkinje fibers. *J. Physiol. (Lond.)*. 229:99.
- GRUNDFEST, H. 1966. Heterogeneity of excitable membrane: electrophysiological and pharmacological evidence and some consequences. *Ann. N. Y. Acad. Sci.* 137:901.
- HAUSWIRTH, O., D. NOBLE, and R. W. TSIEN. 1968. Adrenaline: mechanism of action on the pacemaker potential in cardiac Purkinje fibers. *Science (Wash. D. C.)*. 162:916.
- HAUSWIRTH, O., D. NOBLE, and R. W. TSIEN. 1972. Separation of the pacemaker and plateau components of delayed rectification in cardiac Purkinje fibres. *J. Physiol. (Lond.)*. 225:211.
- HIROAKA, M., and H. H. HECHT. 1973. Recovery from hypothermia in cardiac Purkinje fibers: considerations for an electrogenic mechanism. *Pfluegers Archiv. Gesamte Physiol. Menschen Tiere.* 339:25.
- HODGKIN, A. L., and A. F. HUXLEY. 1952. A quantitative description of membrane current and its application to conduction and excitation in nerve. *J. Physiol. (Lond.)*. 117:500.
- HOROWICZ, P., P. GAGE, and R. S. EISENBERG. 1968. The role of electrochemical gradient in determining potassium fluxes in frog striated muscle. *J. Gen. Physiol.* 51:1935.
- JACK, J. J. B., D. NOBLE, and R. W. TSIEN. 1974. *Electric Current Flow in Excitable Cells*. Oxford University Press, Inc., New York. In press.
- JOHNSON, E. A., and M. LIEBERMAN. 1971. Heart: Excitation and Contraction. *Annu. Rev. Physiol.* 33:479.
- KASSEBAUM, D. G. 1964. Membrane effects of epinephrine in the heart. *Proc. Int. Pharmacol. Meet.* 5:95.
- KASSEBAUM, D. G., and VAN DYKE. 1966. Electrophysiological effects of isoproterenol on Purkinje fibers of the heart. *Circ. Res.* 19:940.
- KOHLHARDT, M., B. BAUER, H. KRAUSE, and A. FLECKENSTEIN. 1972. Differentiation of the transmembrane Na and Ca channels in mammalian cardiac fibres by the use of specific inhibitors. *Pfluegers Archiv. Gesamte Physiol. Menschen Tiere.* 317:359.
- MCALLISTER, R. E., and D. NOBLE. 1966. The time and voltage dependence of the slow outward current in cardiac Purkinje fibres. *J. Physiol. (Lond.)*. 186:632.
- MCNAUGHTON, P. A., and D. NOBLE. 1973. The role of intracellular calcium ion concentration in mediating the adrenaline-induced acceleration of the cardiac pacemaker potential. *J. Physiol. (Lond.)*. 234:53.

- MOBLEY, B. A., and E. PAGE. 1972. The surface area of sheep cardiac Purkinje fibres. *J. Physiol. (Lond.)*. 220:547.
- MOORE, L. E., and E. JACOBSSON. 1971. Interpretation of the sodium permeability changes of myelinated nerve in terms of linear relaxation theory. *J. Theor. Biol.* 33:77.
- NEW, W., and W. TRAUTWEIN. 1972. Inward membrane currents in mammalian myocardium. *Pfluegers Archiv. Gesamte Physiol. Menschen Tiere*. 334:1.
- NOBLE, D., and R. W. TSIEN. 1968. The kinetics and rectifier properties of the slow potassium current in cardiac Purkinje fibres. *J. Physiol. (Lond.)*. 195:185.
- OTSUKA, M. 1958. Die Wirkung von Adrenalin auf Purkinje-Fasern von Säugetierherzen. *Pfluegers Archiv. Gesamte Physiol. Menschen Tiere*. 226:512.
- PEPER, K., and W. TRAUTWEIN. 1969. A note on the pacemaker current in Purkinje fibres. *Pfluegers Archiv. Gesamte Physiol. Menschen Tiere*. 309:356.
- REUTER, H. 1965. Über den Einfluss von Pharmaka auf die Kopplung von Erregung und Kontraktion im Herzen. Habilitationsschrift, University of Mainz, Mainz, Germany.
- SOMMER, J. R., and E. A. JOHNSON. 1968. Cardiac muscle: a comparative study of Purkinje fibres and ventricular fibres. *J. Cell. Biol.* 3:497.
- TRAUTWEIN, W., and R. F. SCHMIDT. 1960. Zur Membranwirkung des Adrenalins an der Herzmuskelfaser. *Pfluegers Archiv. Gesamte Physiol. Menschen Tiere*. 271:715.
- TSIEN, R. W. 1970. The kinetics of conductance changes in heart cells. Ph.D. Thesis. Oxford University.
- TSIEN, R. W. 1973. Control of conductance in cardiac membrane permeability. *Neurosci. Res. Program Bull.* 11:204.
- TSIEN, R. W. 1974. Mode of action of chronotropic agents in cardiac Purkinje fibers: does epinephrine act by directly modifying the external surface charge? *J. Gen. Physiol.* 64:320.
- TSIEN, R. W., W. R. GILES, and P. GREENGARD. 1972. Cyclic AMP mediates the action of epinephrine on the action potential plateau of cardiac Purkinje fibres. *Nat. New Biol.* 240:181.
- TSIEN, R. W., and D. NOBLE. 1969. A transition state theory approach to the kinetics of conductance changes in excitable membranes. *J. Membr. Biol.* 1:248.
- VASSALLE, M. 1966. Analysis of cardiac pacemaker potential by means of a "voltage-clamp" technique. *Am. J. Physiol.* 210:1334.
- VASSALLE, M. 1970. Electrogenic suppression of automaticity in sheep and dog Purkinje fibers. *Circ. Res.* 27:361.
- VASSALLE, M., and O. BARNABEI. 1971. Norepinephrine and potassium fluxes in cardiac Purkinje fibres. *Pfluegers Archiv. Gesamte Physiol. Menschen Tiere*. 322:287.
- VITEK, M., and W. TRAUTWEIN. 1971. Slow inward current and action potential in cardiac Purkinje fibres. The effect of Mn^{++} ions. *Pfluegers Archiv. Gesamte Physiol. Menschen Tiere*. 323:204.
- WEIDMANN, S. 1955 a. The effect of the cardiac membrane potential on the rapid availability of the sodium carrying system. *J. Physiol. (Lond.)*. 127:213.
- WEIDMANN, S. 1955 b. Effects of calcium ions and local anesthetics on electrical properties of Purkinje fibres. *J. Physiol. (Lond.)*. 129:568.