

## Phospholipase C- $\gamma$ 1 Interacts with Conserved Phosphotyrosyl Residues in the Linker Region of Syk and Is a Substrate for Syk

CHE-LEUNG LAW,\* KAREN A. CHANDRAN, SVETLANA P. SIDORENKO,†  
AND EDWARD A. CLARK

*Department of Microbiology, University of Washington,  
Seattle, Washington 98195*

Received 24 July 1995/Returned for modification 27 September 1995/Accepted 3 January 1996

**Antigen receptor ligation on lymphocytes activates protein tyrosine kinases and phospholipase C- $\gamma$  (PLC- $\gamma$ ) isoforms. Glutathione *S*-transferase fusion proteins containing the C-terminal Src-homology 2 [SH2(C)] domain of PLC- $\gamma$ 1 bound to tyrosyl phosphorylated Syk. Syk isolated from antigen receptor-activated B cells phosphorylated PLC- $\gamma$ 1 on Tyr-771 and the key regulatory residue Tyr-783 *in vitro*, whereas Lyn from the same B cells phosphorylated PLC- $\gamma$ 1 only on Tyr-771. The ability of Syk to phosphorylate PLC- $\gamma$ 1 required antigen receptor ligation, while Lyn was constitutively active. An mCD8-Syk cDNA construct could be expressed as a tyrosyl-phosphorylated chimeric protein tyrosine kinase in COS cells, was recognized by PLC- $\gamma$ 1 SH2(C) *in vitro*, and induced tyrosyl phosphorylation of endogenous PLC- $\gamma$ 1 *in vivo*. Substitution of Tyr-525 and Tyr-526 at the autophosphorylation site of Syk in mCD8-Syk substantially reduced the kinase activity and the binding of this variant chimera to PLC- $\gamma$ 1 SH2(C) *in vitro*; it also failed to induce tyrosyl phosphorylation of PLC- $\gamma$ 1 *in vivo*. In contrast, substitution of Tyr-348 and Tyr-352 in the linker region of Syk in mCD8-Syk did not affect the kinase activity of this variant chimera but almost completely eliminated its binding to PLC- $\gamma$ 1 SH(C) and completely eliminated its ability to induce tyrosyl phosphorylation of PLC- $\gamma$ 1 *in vivo*. Thus, an optimal kinase activity of Syk and an interaction between the linker region of Syk with PLC- $\gamma$ 1 are required for the tyrosyl phosphorylation of PLC- $\gamma$ 1.**

The B-cell receptor (BCR) complex consists of the surface immunoglobulin (sIg) noncovalently linked to the Ig $\alpha$ /Ig $\beta$  heterodimer with cytoplasmic tails containing immunoreceptor tyrosine-based activation motifs responsible for signal transduction (4, 31). Members of the Src family of protein tyrosine kinases (PTK), including Lyn, Blk, and Fyn, and a member of the Syk/Zap70 family, Syk, are among the signal-transducing molecules that interact with the BCR (4, 31).

Stimulation of the BCR complex induces rapid tyrosyl phosphorylation of receptor-associated PTKs and activates both phospholipase C- $\gamma$ 1 (PLC- $\gamma$ 1) (6) and PLC- $\gamma$ 2 (11). The hydrolysis of phosphoinositides by activated PLC- $\gamma$  isoforms into diacylglycerol and inositol phosphates results in activation of protein kinase C and increases in the concentration of intracellular free Ca<sup>2+</sup> (2). Ligands of receptor protein tyrosine kinases (RPTK), e.g., epidermal growth factor (EGF) and platelet-derived growth factor (PDGF) receptors (5, 9), induce receptor oligomerization and autophosphorylation, generating docking sites for Src homology domains (SH2) including the C-terminal SH2 domain of PLC- $\gamma$ 1. This allows RPTK to phosphorylate and activate PLC- $\gamma$ 1. PLC- $\gamma$  isoforms are *in vitro* substrates for Src family kinases (23), and SH2 domains of Src family kinases can bind to tyrosyl-phosphorylated PLC- $\gamma$ 2 (30).

In leukocytes, the PTKs Syk and Zap-70 are required for the activation of PLC- $\gamma$  isoforms in cytotoxic T cells (16), a chicken B-cell line (17, 41), and basophils (32). A lack of Zap-70

expression is the underlying cause of an autosomal recessive form of severe combined immunodeficiency characterized by the failure of CD4<sup>+</sup> T cells to respond to antigen receptor stimulation and by an absence of peripheral CD8<sup>+</sup> T cells (1, 8, 10). Recently, we reported that Syk, PLC- $\gamma$ 1, and a 120-kDa phosphoprotein form a complex in human B cells (38). Despite evidence implying an essential function of the Syk/Zap-70 kinases in the antigen receptor-mediated activation of PLC- $\gamma$  isoforms in both B and T lymphocytes, relatively little is known about the nature of the physical connections between PLC- $\gamma$  isoforms, PTKs, and the antigen receptor *in vivo*. It is also unclear which PTK(s) actually phosphorylates PLC- $\gamma$  isoforms on tyrosines (Tyr) upon ligation of the antigen receptors.

In this report, we present evidence that (i) PLC- $\gamma$ 1 can directly interact with Syk via its C-terminal SH2 domain; (ii) Syk isolated from BCR-activated B cells can phosphorylate PLC- $\gamma$ 1 *in vitro* on a key regulatory Tyr residue that is involved in the *in vivo* activation of PLC- $\gamma$ 1; and (iii) both the binding of PLC- $\gamma$ 1 SH2(C) to Syk and *in vivo* tyrosine phosphorylation of PLC- $\gamma$ 1 are dependent on two Tyr residues (Tyr-348 and Tyr-352), which are located in the linker region joining the C-terminal SH2 domain and the kinase domain of Syk. We propose that Syk in lymphocytes is functionally analogous to receptor PTKs, including the EGF (5) and the PDGF (9) receptors, in such a way that upon oligomerization, Syk phosphorylates itself, is bound by PLC- $\gamma$ 1 via its SH2(C) domain, and thus can phosphorylate and activate PLC- $\gamma$ 1.

### MATERIALS AND METHODS

**Cells, antibodies, and reagents.** COS cells and the Burkitt's lymphoma lines Daudi and Ramos were maintained as previously described (20). Anti-Syk serum and anti-phosphotyrosine monoclonal antibody (MAb) PY20 were purchased from Santa Cruz Biotechnology, La Jolla, Calif.; biotinylated anti-phosphotyrosine MAb 4G10 and mouse anti-PLC- $\gamma$ 1 were purchased from Upstate Biotechnology, Lake Placid, N.Y.; and rabbit anti-PLC- $\gamma$ 1 serum was a kind gift from Graham Carpenter, Vanderbilt University. Normal goat IgG F(ab')<sub>2</sub> and

\* Corresponding author. Mailing address: Department of Microbiology, Box 357242, University of Washington, Seattle, WA 98195. Phone: (206) 543-7169. Fax: (206) 685-0305. Electronic mail address: cheleung@u.washington.edu.

† Permanent address: Kavetsky Institute of Experimental Pathology, Oncology and Radiology, Ukrainian Academy of Sciences, Kiev, Ukraine.

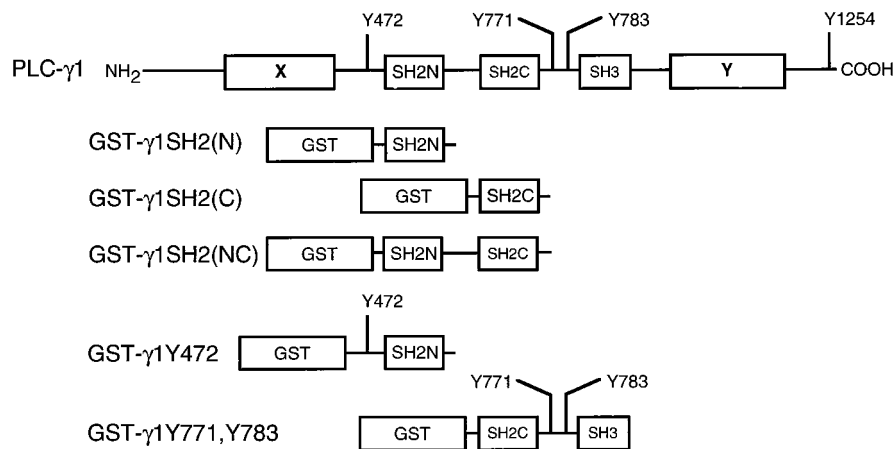

FIG. 1. PLC- $\gamma$ 1 fusion protein constructs. The locations of Tyr residues in PLC- $\gamma$ 1 known to be phosphorylated by activated growth factor receptor PTK are indicated in the top diagram. Lower diagrams show the different portions of PLC- $\gamma$ 1 that were included in each of the GST fusion protein constructs. Replacement of Y-771 or Y-783 with Phe in GST- $\gamma$ 1Y771,Y783 gives GST- $\gamma$ 1Y771F or GST- $\gamma$ 1Y783F, respectively.

goat anti-human IgM F(ab')<sub>2</sub> were purchased from Jackson ImmunoResearch, West Grove, Pa. Normal rat IgG was purchased from Pierce, Rockford, Ill. Rat anti-mouse CD8 $\alpha$ , 53-6.72, was obtained from the American Type Culture Collection, Rockville, Md. Glutathione-agarose was purchased from Sigma, St. Louis, Mo., and protein A- and protein G-Sepharose were purchased from Pharmacia Biotech, Piscataway, N.J.

**Plasmid constructs.** For the generation of glutathione *S*-transferase (GST) fusion proteins containing the SH2 domains of PLC- $\gamma$ 1 and substrates for the *in vitro* kinase assay (Fig. 1), cDNAs encoding different regions of PLC- $\gamma$ 1 were generated by using total RNA from Daudi cells as the template and reverse transcription-PCR with Superscript reverse transcriptase (Life Technologies, Gaithersburg, Md.). The following primer pairs were used:

GST- $\gamma$ 1SH2(N)  
 5' primer: 5' GCG GGA TCC TCC AAT GAG AAG TGG TTC CAT 3'  
 3' primer: 5' GCG GAA TTC GGC GTT GGT CTG TGG GAC AGG 3'  
 GST- $\gamma$ 1SH2(C)  
 5' primer: 5' GCG GGA TCC GAG AGC AAA GAA TGG TAC CAC 3'  
 3' primer: 5' GCG GAA TTC TGC CTC CTC GTT GAT GGG ATA 3'  
 GST- $\gamma$ 1SH2(NC)  
 5' primer: 5' GCG GGA TCC TCC AAT GAG AAG TGG TTC CAT 3'  
 3' primer: 5' GCG GAA TTC TGC CTC CTC GTT GAT GGG ATA 3'  
 GST- $\gamma$ 1Y472  
 5' primer: 5' GCG GGA TCC TCA CCC AAC CAG CTT AAG 3'  
 3' primer: 5' GCG GAA TTC GGC GTT GGT CTG TGG GAC AGG 3'  
 GST- $\gamma$ 1Y771,Y783  
 5' primer: 5' GCG GGA TCC GAG AGC AAA GAA TGG TAC CAC 3'  
 3' primer: 5' GCG GAA TTC TCC AGG GCC ACG GGG TTG 3'

Underlined nucleotides indicate *Bam*HI and *Eco*RI sites in the 5' and 3' primers, respectively; these sites were used to clone the PCR products into the pGEX-2T vector (Pharmacia Biotech) for protein production in *Escherichia coli* BL21(DE3). For the construction of the mCD8-Syk chimera, a cDNA encoding the extracellular and transmembrane domains of mouse CD8 $\alpha$  (mCD8) was generated by reverse transcription-PCR with total RNA from a CD8<sup>+</sup> mouse cytotoxic T-lymphocyte clone as template, a 5' primer of 5' GCG GCG GCC GCC CAC ACC ATG GCC TCA CCG TTG ACC 3', and a 3' primer of 5' GCG GGA TCC CCT GTG GTA GCA GAT GAG AGT 3'. Underlined nucleotides are *Not*I and *Bam*HI sites used for cloning. The coding region of human Syk was amplified by using the 5' primer 5' GCG GGA TCC GCC ATG GCT GAC AGC GCC AAC CAC 3', the 3' primer 5' GCG GAA TTC TTA GTT CAC CAC GTC ATA GTA GTA ATT 3', and pHSyk-1 (20) as the template. The PCR product was cut with *Bam*HI and *Eco*RI (at the underlined nucleotides) and cloned into the pBluescript II SK<sup>+</sup> vector (Stratagene, La Jolla, Calif.). The insert was then excised from the pBluescript plasmid with *Bam*HI and *Xho*I and ligated together with the cut mCD8 $\alpha$  fragment into *Not*I-*Xho*I-cut expression vector pCDNA3 (Invitrogen, San Diego, Calif.). Site-directed mutagenesis was conducted with the Unique site elimination kit (Pharmacia Biotech) and the appropriate selection and mutagenesis primers. Two variants of the GST- $\gamma$ 1Y771,Y783 with either Tyr-771 or Tyr-783 substituted with phenylalanine (Phe) to give GST- $\gamma$ 1Y771F or GST- $\gamma$ 1Y783F, respectively, were generated. Four variants of mCD8-Syk with either Lys-397 and Lys-402 replaced with Gln (mCD8-SykATP<sup>-</sup>), Tyr-296 replaced with Phe (mCD8-SykY296F), Tyr-348 and Tyr-352 replaced with Phe (mCD8-SykY348F,Y352F), or Tyr-525 and Tyr-526

replaced with Phe (mCD8-SykY525F,Y526F) were also generated. All constructs were sequenced to confirm sequence fidelity.

**Purification of GST fusion proteins.** Overnight cultures of *E. coli* BL21(DE3) containing the expression plasmids were diluted 10-fold into new medium plus 50  $\mu$ g of ampicillin per ml and cultured for 1 h at 37°C. Expression of fusion proteins was induced by the addition of 0.1 mM isopropyl- $\beta$ -D-thiogalactoside (IPTG) for 2.5 h at 30°C. Cells were then pelleted and resuspended in phosphate-buffered saline (PBS) containing 0.1% Triton X-100, 2 mM phenylmethylsulfonyl fluoride, 10  $\mu$ g of aprotinin per ml, 10  $\mu$ g of leupeptin per ml, 1  $\mu$ g of pepstatin per ml, and 100  $\mu$ g of soybean trypsin inhibitor per ml. Lysis was done by sonication for 1 min on ice. Cell debris was removed by centrifugation at 15,000  $\times$  g for 15 min at 4°C. Supernatants were filtered through 0.45- $\mu$ m-pore-size filters and then passed over 2 ml of glutathione-agarose pre-equilibrated in PBS. The glutathione-agarose beads were washed with 30 volumes of PBS. Bound GST fusion proteins were eluted with 10 mM of glutathione in 50 mM Tris (pH 8.0) and dialyzed against PBS. Protein concentrations were determined by the Bradford assay.

**COS cell transfection.** The DEAE-dextran method was used to transiently express cDNAs in COS cells. Briefly, COS cells were seeded at approximately 3  $\times$  10<sup>6</sup> cells per 150-mm-diameter plate 16 h before transfection. The cells were washed twice with serum-free Dulbecco modified Eagle medium. Transfection medium containing 400  $\mu$ g of DEAE-dextran per ml, 0.1 mM chloroquine, and 3  $\mu$ g of cDNA constructs per ml was added. After a 3- to 4-h incubation at 37°C in a tissue culture incubator, the cells were pulsed with 10% dimethyl sulfoxide in 1  $\times$  PBS at room temperature for 2 min and then returned to fully supplemented Dulbecco modified Eagle medium. After 24 h, the medium was replaced with Dulbecco modified Eagle medium containing 5% fetal calf serum. Cells were harvested for analysis 72 h after transfection.

**B-cell stimulation.** The Burkitt's lymphoma cell line Daudi or Ramos was pelleted and resuspended in fully supplemented RPMI 1640 at 10  $\times$  10<sup>6</sup> cells per ml. Cells were allowed to equilibrate at 37°C for 10 to 15 min. Stimulation was initiated by adding F(ab')<sub>2</sub> fragments of goat anti-human IgM to a final concentration of 10  $\mu$ g/ml or by adding 2.5 mM H<sub>2</sub>O<sub>2</sub> plus 100  $\mu$ M sodium orthovanadate. The control for F(ab')<sub>2</sub> fragments of goat anti-human IgM was either F(ab')<sub>2</sub> fragments of normal goat IgG or F(ab')<sub>2</sub> fragments of goat anti-mouse IgM, and the control for H<sub>2</sub>O<sub>2</sub> plus orthovanadate was medium. Stimulation was stopped by dilution of the cell suspensions into >10 volumes of ice-cold 1  $\times$  PBS-0.02% Na<sub>3</sub>. The cells were pelleted and washed once more with ice-cold PBS before lysis in 0.5% Nonidet P-40 lysis buffer (150 mM NaCl, 50 mM Tris [pH 8.0], 5 mM EDTA) supplemented with protease inhibitors (2 mM phenylmethylsulfonyl fluoride, 10  $\mu$ g of aprotinin per ml, 10  $\mu$ g of leupeptin per ml, 1  $\mu$ g of pepstatin per ml, and 100  $\mu$ g of soybean trypsin inhibitor per ml) and phosphatase inhibitors (10 mM NaF, 1 mM Na<sub>3</sub>VO<sub>4</sub>, and 5 mM Na<sub>4</sub>P<sub>2</sub>O<sub>7</sub>).

**Immunoprecipitation and Western blotting.** Immunoprecipitation, sodium dodecyl sulfate-polyacrylamide gel electrophoresis (SDS-PAGE), and the *in vitro* kinase assay were performed as described previously (22). Western blotting (immunoblotting) was performed with an enhanced chemiluminescence (ECL) kit (Amersham Life Science, Arlington Heights, Ill.). In Western blotting with GST fusion proteins, the blots were incubated with 20 nM fusion proteins in Tris-buffered saline (10 mM Tris [pH 8.0], 150 mM NaCl) plus 0.01% Tween 20 and 2.5% bovine serum albumin for 2 h at room temperature. Binding of GST fusion proteins was detected by an anti-GST MAb (Santa Cruz Biotechnology) plus horseradish peroxidase-conjugated goat anti-mouse serum (Jackson ImmunoResearch) and ECL.

## RESULTS

**SH2 domains of PLC- $\gamma$ 1 bind to Syk.** Since SH2 domains recognize tyrosyl-phosphorylated ligands (29), we reasoned that upon stimulation of the sIgM/BCR, the SH2 domains of PLC- $\gamma$ 1 might be responsible for relocalizing PLC- $\gamma$ 1 to BCR-activated PTK(s) to facilitate its own activation. To test this, we generated GST fusion proteins containing either the N-terminal [GST- $\gamma$ 1SH2(N)], C-terminal [GST- $\gamma$ 1SH2(C)], or both [GST- $\gamma$ 1SH2(NC)] SH2 domains of PLC- $\gamma$ 1 (Fig. 1). B cells were stimulated by cross-linking IgM receptors or H<sub>2</sub>O<sub>2</sub> plus sodium orthovanadate, which elicit signal transduction events in lymphocytes resembling antigen receptor-mediated signaling (35–37). Figure 2A shows that GST- $\gamma$ 1SH2(NC) recognized similar patterns of tyrosyl-phosphorylated proteins from B cells activated by either anti-IgM or H<sub>2</sub>O<sub>2</sub> plus sodium orthovanadate. GST- $\gamma$ 1SH2(N) and GST- $\gamma$ 1SH2(C) each precipitated a subset of these proteins. Thus, GST- $\gamma$ 1SH2(N) precipitated 140- and 70-kDa phosphoproteins whereas GST- $\gamma$ 1SH2(C) precipitated 120-, 80-, 76-, and 70-kDa phosphoproteins (Fig. 2A, upper panel). Western blotting with an anti-Syk serum revealed that Syk was part of the 70-kDa protein band present in the GST- $\gamma$ 1SH2(NC) precipitates obtained from activated B cells (Fig. 2A, lower panel). To determine if the interaction between the SH2 domains of PLC- $\gamma$ 1 and Syk was direct, GST fusion proteins were used in a Western blot of Syk isolated from resting or anti-IgM-activated B cells. GST- $\gamma$ 1SH2(C) and GST- $\gamma$ 1SH2(NC) recognized tyrosyl-phosphorylated Syk isolated from anti-IgM-activated B cells (Fig. 2B), but GST- $\gamma$ 1SH2(N) and GST alone did not (data not shown). GST- $\gamma$ 1SH2(C) also precipitated a 70-kDa phosphoprotein which was not recognized by the anti-Syk serum (Fig. 2A); however, GST- $\gamma$ 1SH2(C) clearly bound to tyrosyl-phosphorylated Syk on Western blots (Fig. 2B). It is possible that GST- $\gamma$ 1SH2(C) bound to only a small amount of highly tyrosyl-phosphorylated Syk in solution, which could not be detected by the anti-Syk serum used in this study. Alternatively, GST- $\gamma$ 1SH2(C) might precipitate another 70-kDa tyrosyl-phosphorylated protein(s) in addition to Syk. Taken together, these data demonstrate that PLC- $\gamma$ 1 can directly interact with Syk via its SH2 domains; the SH2(C) domain probably confers the specificity for interacting with Syk (Fig. 2; also see Fig. 5).

**Syk phosphorylates PLC- $\gamma$ 1 in vitro.** Tyr-472, Tyr-771, Tyr-783, and Tyr-1254 of PLC- $\gamma$ 1 can be phosphorylated in vitro by activated EGF receptors (15, 26, 44) and in vivo by activated PDGF receptors (14). Phosphorylation of Tyr-783 and Tyr-1254 correlates with the activation of PLC- $\gamma$ 1 in vivo by PDGF (14). Since GST- $\gamma$ 1SH2(C) bound to tyrosyl-phosphorylated Syk, we examined if Syk could phosphorylate PLC- $\gamma$ 1. GST fusion proteins containing either Tyr-472 (GST- $\gamma$ 1Y472) or Tyr-771 and Tyr-783 (GST- $\gamma$ 1Y771,Y783) of PLC- $\gamma$ 1 were used as substrates in kinase assays (Fig. 1). Syk isolated from control stimulated or anti-IgM-stimulated B cells had little activity against GST (Fig. 3A). Syk isolated from control stimulated B cells also did not phosphorylate GST- $\gamma$ 1Y472 and had minimal activity against GST- $\gamma$ 1Y771,Y783 (Fig. 3A). In contrast, Syk isolated from anti-IgM stimulated B cells not only showed increased autophosphorylation but also strongly phosphorylated GST- $\gamma$ 1Y771,Y783 (Fig. 3A). Phosphoamino acid analysis confirmed that phosphorylation on GST- $\gamma$ 1Y771,Y783 was exclusively on Tyr residues (data not shown). Substituting Tyr-771 or Tyr-783 with Phe greatly reduced the levels of phosphorylation of these substrates, showing that in vivo-activated Syk phosphorylated GST- $\gamma$ 1Y771,Y783 on both Tyr-771 and Tyr-783 (Fig. 3A). The BCR-associated PTK Lyn also phosphorylated GST- $\gamma$ 1Y771,Y783 (Fig. 3B), but unlike Syk,

this activity was present in unstimulated cells and only modestly increased in response to anti-IgM stimulation. Interestingly, whereas the level of phosphorylation of GST- $\gamma$ 1Y771F by Lyn was greatly reduced, phosphorylation of GST- $\gamma$ 1Y783 was similar to that of GST- $\gamma$ 1Y771,Y783, suggesting that Lyn, unlike Syk, phosphorylated GST- $\gamma$ 1Y771,Y783 principally on Tyr-771 (Fig. 3B). Similar results were obtained when another Src family kinase, Fgr, was tested instead of Lyn (data not shown). No phosphorylation of GST- $\gamma$ 1Y472 by either Syk or Lyn was detectable. These data show that Syk could phosphorylate PLC- $\gamma$ 1 in vitro on a key Tyr (Tyr-783), which is essential for initiating the enzymatic activity of PLC- $\gamma$ 1 (14).

**A chimera of mCD8-Syk can be expressed as an active transmembrane PTK in COS cells.** To study the requirements for Syk activation, we generated a plasmid construct made up of the extracellular and transmembrane domains of mCD8 $\alpha$  fused in frame with the complete coding sequence of human Syk (mCD8-Syk) (Fig. 4A). This construct encodes a monomeric PTK of 97 kDa (Fig. 4B, left panel, reducing lanes); when transiently expressed in COS cells, this plasmid produced a disulfide-linked oligomeric (>200-kDa) transmembrane fusion protein (Fig. 4B, left panel, nonreducing lanes). Compared with expressing wild-type cytosolic Syk in COS cells, mCD8-Syk was heavily tyrosyl phosphorylated (Fig. 4B, right panel) and induced high levels of tyrosyl phosphorylation of cellular proteins (Fig. 4C). Tyrosyl phosphorylation of both mCD8-Syk and cellular proteins was strictly dependent on kinase activity; substitution of the two Lys residues in the ATP-binding site with Gln (mCD8-SykATP<sup>-</sup>) reduced the tyrosyl phosphorylation of this chimera to background levels (Fig. 4B). On the other hand, the fusion protein (mCD8-SykY525F,Y526F) with substitutions of Phe at Tyr-525 and Tyr-526 (two Tyr residues at positions corresponding to the autophosphorylation sites in the Src family PTKs [7, 20]) had reduced kinase activity compared with mCD8-Syk but was still tyrosyl phosphorylated (Fig. 4B and C). The residual kinase activity of membrane-associated mCD8-SykY525F,Y526F in vivo, however, was considerably higher than that of soluble wild-type Syk (Fig. 4B and C). These results also suggest that Tyr-525 and/or Tyr-526 are probably not the only Tyr residues in Syk that can be phosphorylated.

**Tyr-525 and Tyr-526 of Syk are required for optimal binding by the SH2 domains of PLC- $\gamma$ 1.** We next determined if GST fusion proteins of PLC- $\gamma$ 1 SH2 domains could interact with either CD8-Syk or mutant CD8-SykY525F,Y526F. GST fusion proteins of PLC- $\gamma$ 1 did not precipitate any detectable tyrosyl-phosphorylated proteins from mock-transfected COS cells (Fig. 5A). Both GST- $\gamma$ 1SH2(C) and GST- $\gamma$ 1SH2(NC) precipitated tyrosyl-phosphorylated proteins 68 to 72 kDa and 87 to 97 kDa in size from COS cells expressing either mCD8-Syk or mCD8-SykY525F,Y526F. The phosphoprotein levels detected in the CD8-SykY525F,Y526F transfectants with the SH2 fusion proteins were lower than those in the mCD8-Syk transfectants. Probing of the precipitates with an anti-Syk serum revealed that GST- $\gamma$ 1SH2(C) and GST- $\gamma$ 1SH2(NC) could indeed precipitate mCD8-Syk (Fig. 5B). In contrast, mCD8-SykY525F,Y526F was only minimally precipitated by GST- $\gamma$ 1SH2(NC) and was not precipitated by GST- $\gamma$ 1SH2(C). These data confirm the results, obtained with activated B cells, that the C-terminal SH2 domain of PLC- $\gamma$ 1 could mediate binding to tyrosyl-phosphorylated Syk (Fig. 2). Furthermore, Tyr-525 and Tyr-526 at the autophosphorylation site of Syk are apparently required for optimal binding of Syk by the SH2 domains of PLC- $\gamma$ 1.

**Tyr-525 and Tyr-526 of Syk are required for the in vivo tyrosyl phosphorylation of PLC- $\gamma$ 1.** The observations that mCD8-Syk was expressed as an active PTK in COS cells and

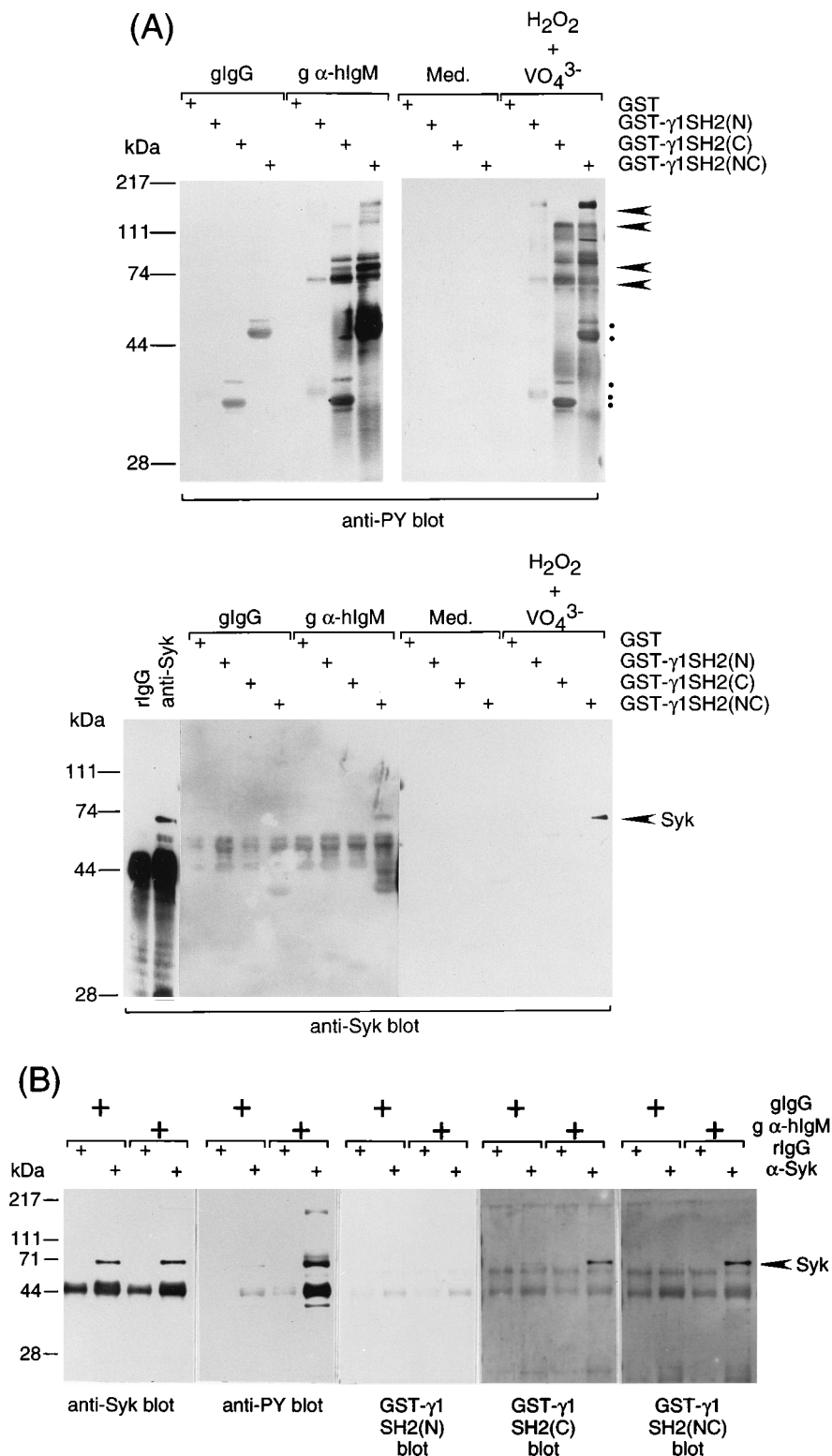

FIG. 2. SH2 domains of PLC-γ1 interact with multiple tyrosyl-phosphorylated proteins including Syk. (A) Nonidet P-40 lysates from Daudi B cells stimulated for 5 min with either 10 μg of control goat IgG (gIgG) per ml, 10 μg of goat anti-human IgM (g α-hlgM) per ml, medium (Med.), or hydrogen peroxide (2.5 mM) plus sodium orthovanadate (100 μM) (H<sub>2</sub>O<sub>2</sub> + VO<sub>4</sub><sup>3-</sup>) were precipitated with 5 μg of GST, GST-γ1SH2(N), GST-γ1SH2(C), or GST-γ1SH2(NC) plus glutathione-agarose. Bound proteins were resolved by reducing SDS-PAGE and immunoblotted with the anti-phosphotyrosine (anti-PY) MAb 4G10 or anti-Syk serum, respectively. Proteins of 33 to 35 and 45 to 48 kDa are the GST fusion proteins (dots). Arrowheads indicate precipitated phosphoproteins (see “SH2 domains of PLC-γ1 bind to Syk” in Results). (B) Syk was immunoprecipitated from Daudi cells stimulated with either goat IgG or goat anti-human IgM, resolved by reducing SDS-PAGE, and immunoblotted with either anti-Syk serum, 4G10 (anti-PY), GST-γ1SH2(N), GST-γ1SH2(C), or GST-γ1SH2(NC). The negative control for the immunoprecipitating anti-Syk serum was normal rabbit IgG (rIgG). Western blotting with GST alone did not detect any proteins (data not shown).

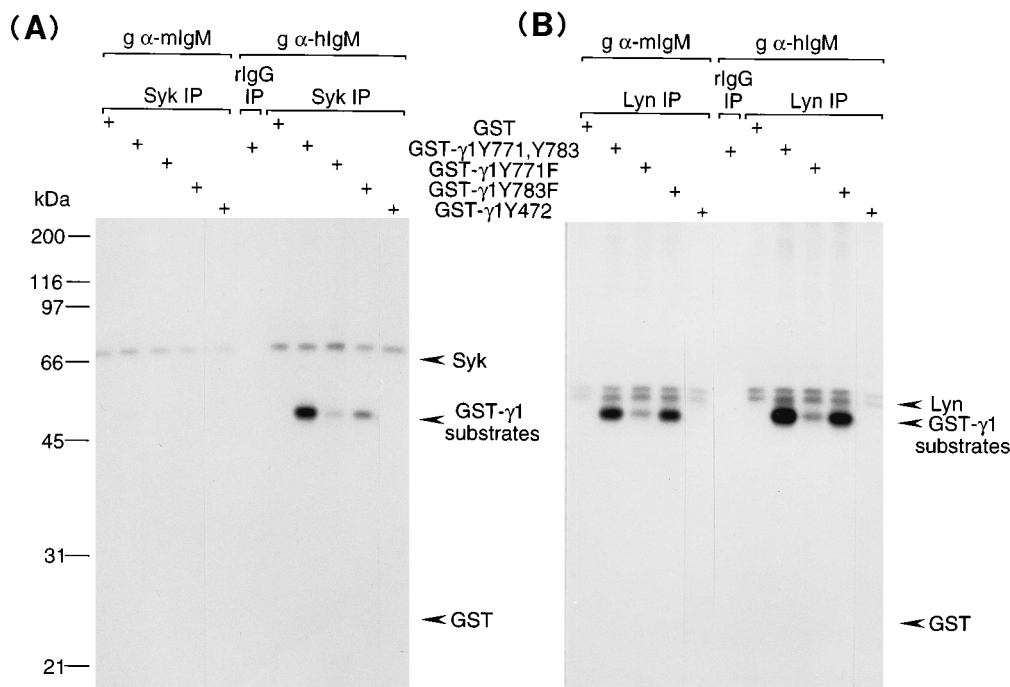

FIG. 3. Phosphorylation of GST PLC- $\gamma$ 1 fusion proteins by Syk and Lyn *in vitro*. Syk (A) and Lyn (B) were immunoprecipitated (Syk IP or Lyn IP) from lysates of Ramos B cells stimulated with goat anti-mouse IgM (g  $\alpha$ -mIgM) or goat anti-human IgM (g  $\alpha$ -hIgM). Immunoprecipitates were then subjected to *in vitro* kinase assays in the presence of the indicated substrates, reducing SDS-PAGE, and autoradiography. A rabbit IgG immunoprecipitate (rlgG IP) plus the GST- $\gamma$ 1Y771,Y783 substrate was used as the negative control. Arrowheads show the mobilities of the indicated proteins.

can be recognized by the PLC- $\gamma$ 1 SH2 domains prompted us to determine if endogenous PLC- $\gamma$ 1 expressed in COS cells could become tyrosyl phosphorylated upon transfection with mCD8-Syk. PLC- $\gamma$ 1 in both mock-transfected COS cells and COS cells transfected with soluble wild-type Syk was not tyrosyl phosphorylated (Fig. 6). Transfection of mCD8-Syk into COS cells resulted in tyrosyl phosphorylation of endogenous PLC- $\gamma$ 1. However, transfection of mCD8-SykY525F,Y526F did not induce tyrosyl phosphorylation of endogenous PLC- $\gamma$ 1 in COS cells (Fig. 6), even though the mutated Syk fusion protein was tyrosyl phosphorylated (Fig. 4B) and augmented the tyrosyl phosphorylation of other cellular proteins (Fig. 4C). Hence, both the kinase activity and Tyr-525 and Tyr-526 of Syk were needed for *in vivo* tyrosyl phosphorylation of PLC- $\gamma$ 1.

**The linker region of Syk contains a binding site for PLC- $\gamma$ 1.** The mCD8-Syk chimeras that can be tyrosyl phosphorylated in COS cells provided a system to further define the PLC- $\gamma$ 1 binding site in Syk. Although Tyr-525 and Tyr-526 of Syk were needed for optimal binding by SH2 domains of PLC- $\gamma$ 1, these Tyr residues do not conform to the PLC- $\gamma$ 1 SH2(C)-binding-site sequence, pTyrXXPro, defined by Songyang et al. (40); therefore, it seemed possible that they would not participate directly in PLC- $\gamma$ 1 binding. A comparison of the amino acid sequences of Syk and Zap-70 revealed 19 conserved Tyr residues; of these, Tyr-348 and Tyr-352 of Syk and Tyr-315 and Tyr-319 of Zap-70, located in the linker region between the SH2 domains and the kinase domains, have the TyrXXPro sequence (Fig. 7). In addition, Tyr-296 of Syk has the TyrXXPro sequence, but this motif is not present in Zap-70 (Fig. 7). Additional variants of mCD8-Syk with Tyr-296 and with Tyr-348 and Tyr-352 substituted with Phe (mCD8-SykY296F and mCD8-

SykY348F,Y352F) were then generated to determine if these sites could participate in PLC- $\gamma$ 1 binding (Fig. 4A). Both variants were expressed in COS cells at comparable levels to that of mCD8-Syk (Fig. 8A, left panel). Phosphotyrosine immunoblotting revealed that whereas mCD8-SykY296F was phosphorylated to the same extent as mCD8-Syk, the level of phosphorylation of mCD8-SykY348F,Y352F was slightly lower (Fig. 8A, left panel). This suggested that Tyr-348 and/or Tyr-352 may be among the autophosphorylation sites in Syk. The enzymatic activities of these two variants were similar to that of mCD8-Syk as indicated by the levels of tyrosyl phosphorylation of COS cell proteins in these transfectants (Fig. 8A, right panel). Thus, these Tyr residues in the linker region probably do not significantly influence Syk activity. The spectrum of proteins precipitated by GST- $\gamma$ 1SH2(C) and GST- $\gamma$ 1SH2(NC) from mCD8-SykY296F transfectants is similar to that precipitated from mCD8-Syk transfectants (Fig. 5A and 8B, left panel). The signals obtained from the mCD8-SykY348F,Y352F transfectant were considerably less intense, in particular the species around 97 kDa (the size of the different mCD8-Syk fusion proteins) (Fig. 8B, left panel). Immunoblotting with an anti-Syk serum of the same precipitates showed that both GST- $\gamma$ 1SH2(C) and GST- $\gamma$ 1SH2(NC) precipitated mCD8-Syk and mCD8-SykY296F (Fig. 8B, right panel). However, even though mCD8-SykY348F,Y352F demonstrated kinase activity comparable to that of mCD8-Syk or mCD8-SykY296F and was tyrosyl phosphorylated, GST- $\gamma$ 1SH2(C) did not bind to it and GST- $\gamma$ 1SH2(NC) showed barely detectable binding (Fig. 8B, right panel). Immunoblotting of PLC- $\gamma$ 1 precipitates revealed that mCD8-SykY296F, like mCD8-Syk, was capable of inducing tyrosyl phosphorylation of PLC- $\gamma$ 1 in COS cells whereas mCD8-SykY348F,Y352F had completely lost this activity (Fig. 8C).

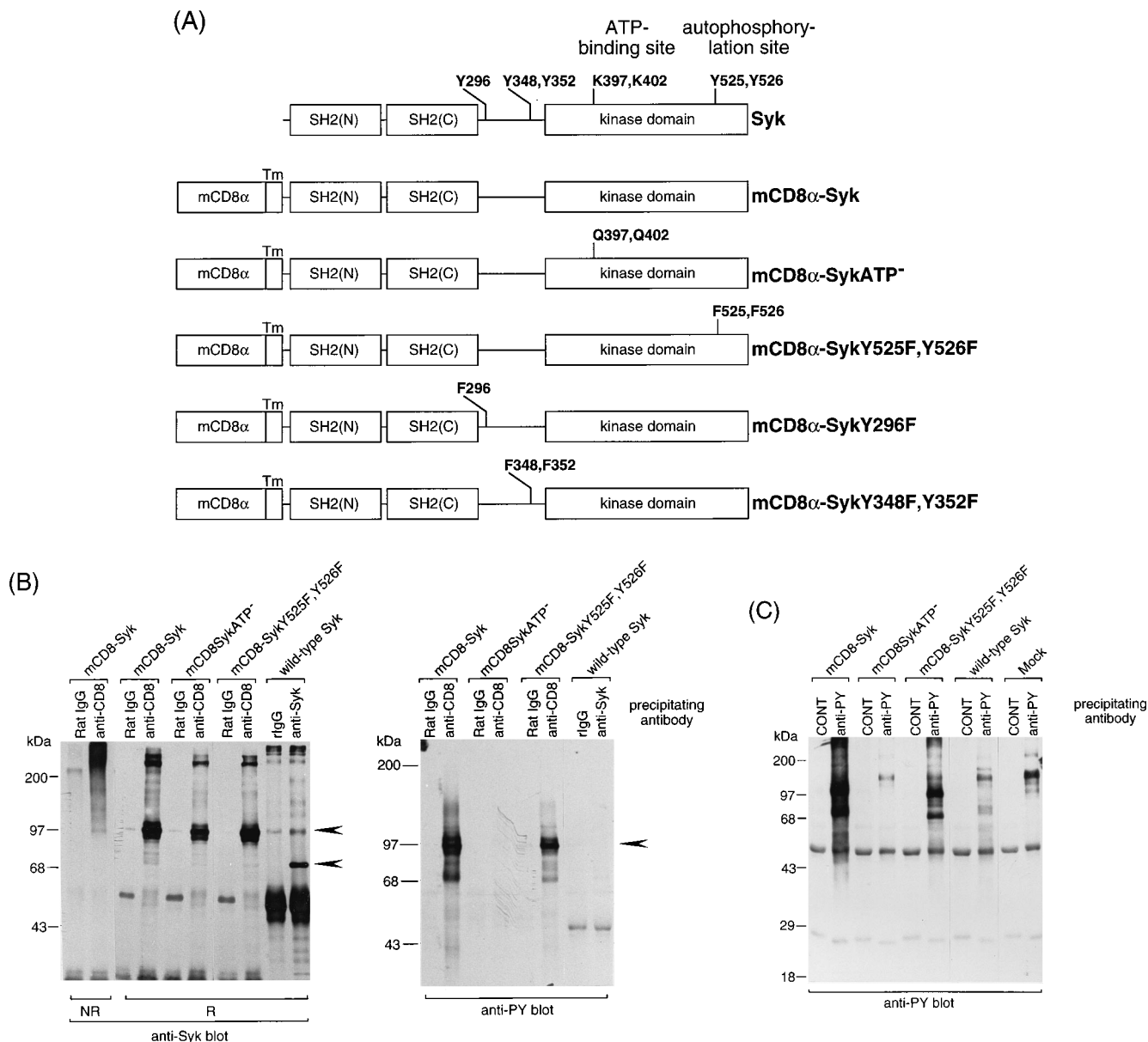

FIG. 4. Expression of mCD8-Syk chimeras in COS cells. (A) Schematics of the different mCD8-Syk constructs used. (B) COS cells were transfected with either the mCD8-Syk, mCD8-SykATP<sup>-</sup>, mCD8-SykY525F,Y526F, or phSyk-1 (Syk) constructs. The chimeras and Syk were immunoprecipitated with either anti-mCD8 $\alpha$  or anti-Syk serum, resolved by reducing (R) or non-reducing (NR) SDS-PAGE, and immunoblotted with either anti-Syk serum (left panel) or 4G10 (anti-PY) (right panel). Arrowheads show the mobilities of the reduced mCD8-Syk chimeras and wild-type Syk. (C) Tyrosyl-phosphorylated proteins from the same transfectants as in panel B were immunoprecipitated with the anti-phosphotyrosine MAb PY20 (anti-PY), resolved by reducing SDS-PAGE, and immunoblotted with 4G10. Normal mouse IgG was used as a control (CONT) for PY20.

## DISCUSSION

Increasing evidence is now available suggesting a critical role for Syk in activating PLC- $\gamma$  isoforms in hematopoietic cells including lymphocytes (1, 8, 16, 17, 41) and basophils (32). In particular, Syk-negative B cells cannot be activated by BCR ligation to tyrosyl phosphorylate PLC- $\gamma$ 2 (41). Although a complex of Syk, PLC- $\gamma$ 1, and a 120-kDa phosphoprotein in B cells can be isolated (38), just how Syk actually activates PLC- $\gamma$ 1 is not clear. A recent report showed that SH2 domains of murine PLC- $\gamma$ 1 can bind to tyrosyl-phosphorylated murine Syk (39). Our results confirm and extend this observation. In

this study, we demonstrate the ability of Syk to tyrosyl phosphorylate PLC- $\gamma$ 1 on a key regulatory residue *in vitro*. The abilities of different mCD8-Syk chimeras to be bound by the SH2 domains of PLC- $\gamma$ 1 *in vitro* were also correlated to the abilities of these chimeras to induce tyrosyl phosphorylation of PLC- $\gamma$ 1 *in vivo*.

Individual SH2 domains of PLC- $\gamma$ 1 precipitated distinct but overlapping sets of tyrosyl-phosphorylated proteins from stimulated B cells (Fig. 2). Phosphoproteins of 140 kDa interacted preferentially with PLC- $\gamma$ 1 SH2(N), whereas phosphoproteins of about 70 kDa interacted preferentially with PLC- $\gamma$ 1 SH2(C). Similar to the SH2 domains of Lyn, Fyn, and Blk (24),

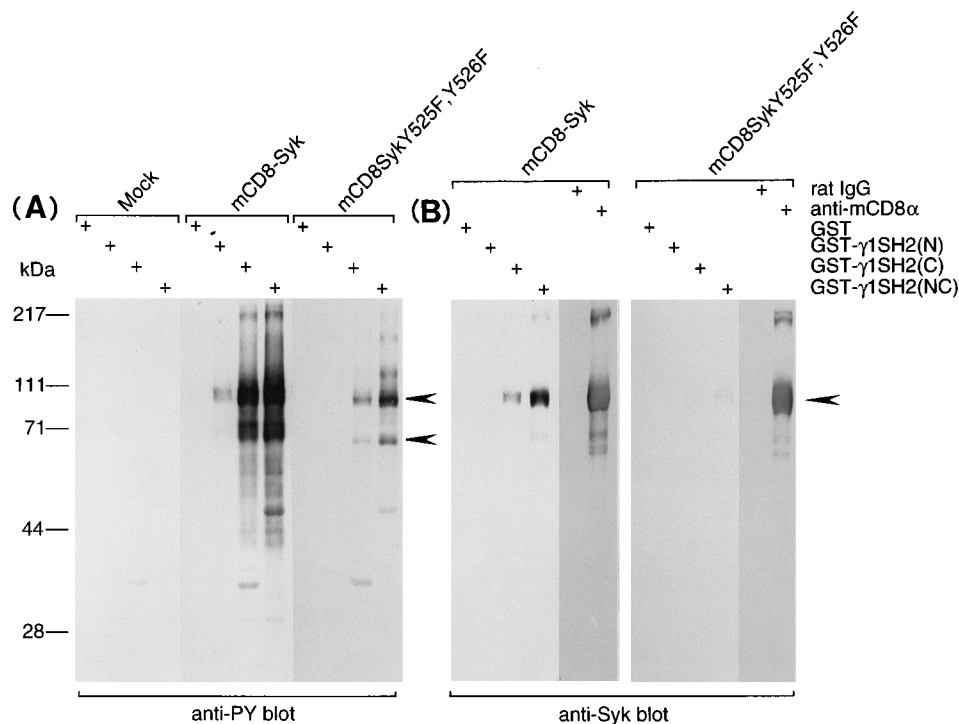

FIG. 5. Tyr-525 and Tyr-526 of Syk are required for binding by GST- $\gamma$ 1SH2(C). COS cells were transfected with either the vector alone (Mock), mCD8-Syk, or mCD8-SykY525F,Y526F constructs. Cell lysates were precipitated with 5  $\mu$ g of GST, GST- $\gamma$ 1SH2(N), GST- $\gamma$ 1SH2(C), or GST- $\gamma$ 1SH2(NC) plus glutathione-agarose. Precipitates were resolved by reducing SDS-PAGE and immunoblotted with either 4G10 (anti-PY) (A) or anti-Syk serum (B). Part of the lysate from the mCD8-Syk and mCD8-SykY525F,Y526F transfectants was also immunoprecipitated with anti-mCD8 $\alpha$  and immunoblotted with anti-Syk to demonstrate comparable levels of transgene expression. Arrowheads show the mobilities of the mCD8-Syk chimera and an additional 72-kDa phosphoprotein precipitated by GST- $\gamma$ 1SH2(C) and GST- $\gamma$ 1SH2(NC).

the SH2 domains of PLC- $\gamma$ 1 also bound to multiple tyrosyl-phosphorylated proteins (Fig. 2). Immunoblotting identified Syk as part of the 70-kDa tyrosyl-phosphorylated proteins precipitated by GST- $\gamma$ 1SH2(NC) (Fig. 2A). Since GST- $\gamma$ 1SH2(C) recognized tyrosyl-phosphorylated Syk on Western blots (Fig. 2B), we conclude that the C-terminal SH2 domain of PLC- $\gamma$ 1 can directly interact with Syk and that the presence of the N-terminal SH2 domain increases overall binding to Syk.

Binding of ligands to RPTKs, e.g., the EGF (33, 45), PDGF (42, 43), and fibroblast growth factor (25) receptors, induces receptor oligomerization and autophosphorylation, which generate docking sites for signal transduction molecules including PLC- $\gamma$ 1. Mutation of Tyr-1021 of the PDGF receptor to Phe blocks both *in vivo* PLC- $\gamma$ 1 binding and ligand-induced increase in intracellular free  $\text{Ca}^{2+}$  concentration, emphasizing the importance of the direct physical interaction between PLC- $\gamma$ 1 and activated RPTK (42, 43). Syk is an integral component of the BCR in both human (20, 21) and murine (3) B cells. Within the BCR complex, Syk can associate with the Ig $\alpha$ -Ig $\beta$  heterodimer (3, 18) and CD22 (19). Augmentation of tyrosyl phosphorylation of Syk and its kinase activity are among the earliest detectable BCR-mediated signal transduction events preceding the activation of PLC- $\gamma$  isoforms and intracellular  $\text{Ca}^{2+}$  mobilization (12, 13, 20). By analogy to the binding of PLC- $\gamma$ 1 to activated RPTKs, we propose that the interaction of PLC- $\gamma$ 1 SH2 domains to tyrosyl-phosphorylated Syk directs PLC- $\gamma$ 1 to the sIgM-BCR during receptor activation. Since the PLC- $\gamma$ 1 SH2 fusion proteins could precipitate additional phosphoproteins from activated B-cell lysates (Fig. 2), it is also possible that PLC- $\gamma$ 1 interacts with other regulatory proteins during B-cell activation. In fact, the 140-kDa

protein precipitated by the N-terminal SH2 fusion protein was recently identified to be the B-cell-associated surface antigen CD22, and both Syk and PLC- $\gamma$ 1 can be found associated with CD22 in activated B cells (19).

Activated EGF receptor phosphorylates PLC- $\gamma$ 1 at Tyr-472, Tyr-771, Tyr-783, and Tyr-1254 *in vitro* (15, 44). Substitution of Tyr-783 and Tyr-1254 of PLC- $\gamma$ 1 profoundly inhibits the PDGF-induced hydrolysis of inositol phospholipids *in vivo* (14). In T lymphocytes, antigen receptor ligation also induces phosphorylation of these Tyr residues in PLC- $\gamma$ 1 (27). However, the PTK(s) responsible for the tyrosyl phosphorylation of PLC- $\gamma$  isoforms in lymphocytes remains to be defined. Mutagenesis studies on the GST- $\gamma$ 1Y771,Y783 substrate for Syk revealed that Tyr-771 and Tyr-783 are two major residues phosphorylated by Syk (Fig. 3), suggesting that Syk can potentially activate PLC- $\gamma$ 1 by phosphorylating Tyr-783 of PLC- $\gamma$ 1. The *in vitro* tyrosyl phosphorylation of GST- $\gamma$ 1Y771,Y783 by Syk is specific, since (i) cross-linking of BCR, a potent stimulus for the enzymatic activity of Syk, dramatically augments its activity toward GST- $\gamma$ 1Y771,Y783 (Fig. 3); (ii) Tyr residues in other parts of PLC- $\gamma$ 1, e.g., Tyr-472, were not phosphorylated by Syk (Fig. 3); and (iii) Syk does not phosphorylate other proteins *in vitro*, including CD22 and enolase, a substrate for variety of PTKs including the Src family kinases (data not shown). Although the Src family kinases can phosphorylate PLC- $\gamma$ 1 and PLC- $\gamma$ 2 (23) and their N-terminal unique regions bind to PLC- $\gamma$ 2 (30) *in vitro*, their roles in the activation of PLC- $\gamma$  isoforms during antigen receptor-mediated lymphocyte activation are still unclear. In this study, the Src family kinases Lyn and Fgr preferentially phosphorylated GST- $\gamma$ 1Y771,Y783 on Tyr-771 but not Tyr-783, the key residues involved in

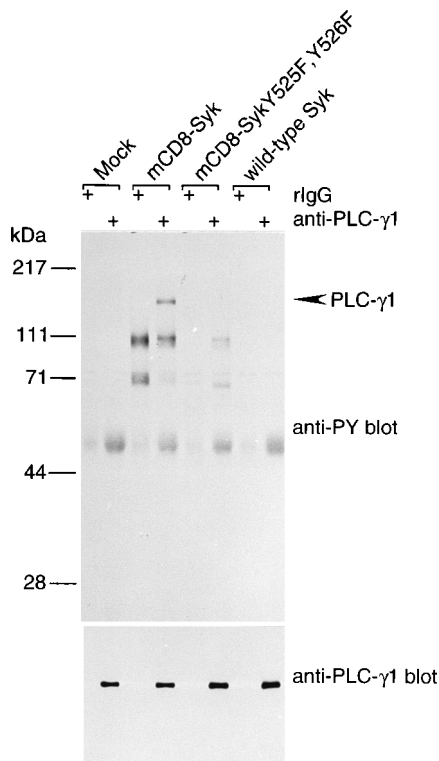

FIG. 6. Tyr-525 and Tyr-526 of Syk are required for CD8-Syk-induced tyrosyl phosphorylation of PLC- $\gamma$ 1 in vivo. COS cells were transfected with either the vector (Mock), mCD8-Syk, mCD8-SykY525F,Y526F, or phSyk-1 (Syk) constructs. PLC- $\gamma$ 1 was immunoprecipitated with a rabbit anti-PLC- $\gamma$ 1 serum, resolved by SDS-PAGE, and immunoblotted with either 4G10 (anti-PY) or a mouse anti-PLC- $\gamma$ 1 MAb.

PLC- $\gamma$ 1 activation in vitro (Fig. 3; data not shown). We also could not detect Lyn among the phosphoproteins that were precipitated by the SH2 domains of PLC- $\gamma$  shown in Fig. 2 (data not shown). Moreover, in the DT40 chicken B-cell line, anti-IgM induces the activation of Syk and PLC- $\gamma$ 2 and augmentation of intracellular free Ca<sup>2+</sup> concentration even in the absence any detectable Src family kinases (41), suggesting that an Src family kinase is not obligatory for the activation of PLC- $\gamma$ 2. With the present observation that Tyr-783 of GST- $\gamma$ 1Y771,Y783 could be phosphorylated by Syk in vitro (Fig. 3),

we propose that Syk may be the PTK that phosphorylates PLC- $\gamma$ 1 in vivo upon antigen receptor stimulation of B cells.

Expression of a mCD8-Syk construct in COS cells alone resulted in the generation of an active transmembrane PTK (Fig. 4). Soluble wild-type Syk, however, showed undetectable tyrosyl phosphorylation and much lower overall PTK activity (Fig. 4B and C). Clustering of Syk activates its activity (16), and mCD8-Syk is oligomeric when expressed in COS cells (Fig. 4A); therefore, it is possible that oligomerization of mCD8-Syk in COS cells alone results in its autophosphorylation and enzymatic activation. Active mCD8-Syk might be able to activate the other PTK(s) present in COS cells. Hence, the overall tyrosyl phosphorylation of the various mCD8-Syk chimera might represent a summation of autophosphorylation and phosphorylation by the other activated PTK(s) in COS cells. Similar to Syk isolated from stimulated B cells (Fig. 3), the mCD8-Syk chimera could phosphorylate GST- $\gamma$ 1Y771,Y783 in vitro on Tyr (data not shown) and could be recognized by GST- $\gamma$ 1SH2(C) and GST- $\gamma$ 1SH2(NC) (Fig. 4 and 7). This not only further supports the notion that the specificity of interaction between Syk and PLC- $\gamma$ 1 is conferred by the C-terminal SH2 domain of PLC- $\gamma$ 1 but also provides us with a convenient tool to define the PLC- $\gamma$ 1-binding site(s) in Syk.

Substitution of Tyr-525 and Tyr-526 resulted in reduced autophosphorylation activity of the chimera and tyrosyl phosphorylation of cellular proteins in COS cells (Fig. 4). Interestingly, this substitution almost completely eliminated the ability of mCD8-SykY525F,Y526F to be bound by the PLC- $\gamma$ 1 SH2 fusion proteins, even though this Syk mutant retained considerable kinase activity (Fig. 3 and 4). Possible explanations for these results are as follows: (i) PLC- $\gamma$ 1 SH2 domains bind directly to the autophosphorylation sites at Tyr-525 and Tyr-526, and (ii) substitution of Tyr-525 and Tyr-526 reduces the enzymatic activity in Syk; consequently, mCD8-SykY525F,Y526F is not able to phosphorylate the appropriate Tyr(s) in Syk which constitutes the actual binding site for the SH2 domains of PLC- $\gamma$ 1. Using a phosphopeptide library, Songyang et al. showed that both SH2 domains of PLC- $\gamma$ 1 bind phosphopeptides of pTyr-hydrophobic-X-hydrophobic with different specificities for the amino acids 3' to the pTyr residue (40). Since the Tyr-525-Tyr-Lys-Ala-Gln sequence at the autophosphorylation site does not conform to this preferred target sequence for PLC- $\gamma$ 1 SH2(C), the second possibility seems more likely.

PLC- $\gamma$ 1 binds to the pTyr-Ile-Ile-Pro-Leu-Pro motif in the cytoplasmic tail of the PDGF receptor (28, 40). This sequence agrees with the pTyrXXPro motif which the C-terminal SH2

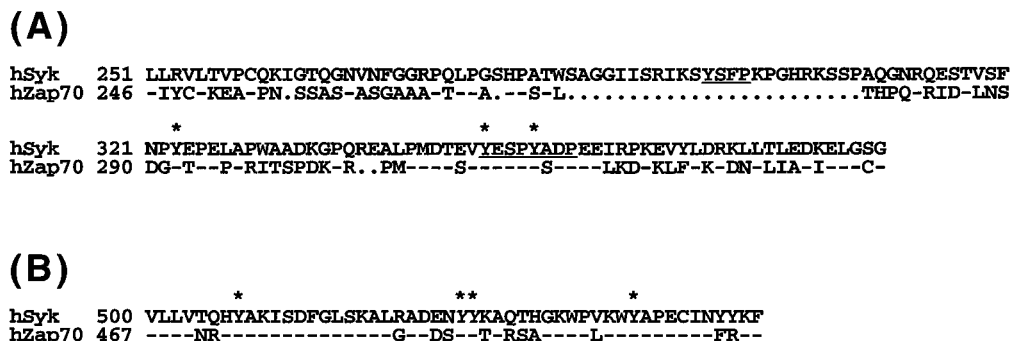

FIG. 7. Amino acid sequence comparison between human Syk (hSyk) and human Zap-70 (hZap70). Linker regions (A) and parts of the kinase domains (B) of hSyk and hZap70 were compared. Dashes indicate conserved residues, and dots indicate gaps. Conserved Tyr residues are marked by asterisks. TyrXXPro motifs are underlined, and Tyr residues at the autophosphorylation sites are in italics.



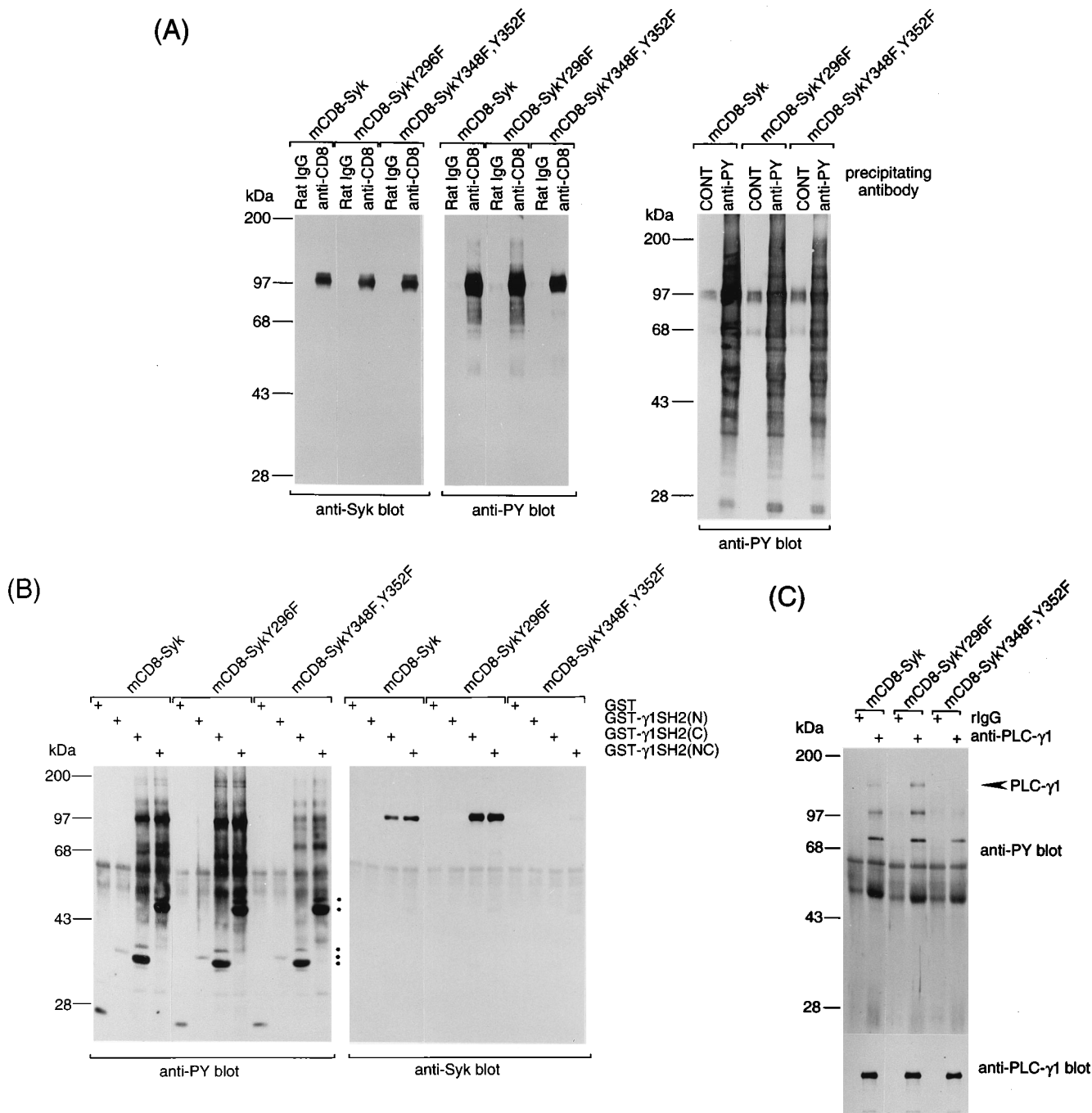

FIG. 8. PLC- $\gamma$ 1 binds to the linker region of Syk. (A) COS cells were transiently transfected with the mCD8-Syk, mCD8-SykY296F, or mCD8-SykY348F, Y352F constructs. Chimeras were immunoprecipitated by anti-mCD8, resolved by reducing SDS-PAGE, and immunoblotted with either an anti-Syk serum or 4G10 (anti-PY) (left panel). Cellular tyrosyl-phosphorylated proteins were immunoprecipitated by PY20, resolved by reducing SDS-PAGE, and immunoblotted with 4G10 (right panel). (B) Cell lysates from the transfectants in panel A were precipitated with GST, GST- $\gamma$ 1SH2(N), GST- $\gamma$ 1SH2(C), or GST- $\gamma$ 1SH2(NC). Proteins were resolved by reducing SDS-PAGE and immunoblotted with either 4G10 (anti-PY) (left panel) or an anti-Syk serum (right panel). Dots on the right side of the anti-PY blot indicate mobilities of the GST fusion proteins and their partially degraded products. (C) PLC- $\gamma$ 1 was precipitated from cell lysates of the transfectant in panel A, resolved by reducing SDS-PAGE, and immunoblotted with either 4G10 (anti-PY) or an anti-PLC- $\gamma$ 1 serum.

domain of PLC- $\gamma$ 1 has been predicted to bind by using a phosphopeptide library (40). Since the C-terminal SH2 domain of PLC- $\gamma$ 1 apparently conferred the specificity for binding to tyrosyl-phosphorylated Syk (Fig. 2, 5, and 7), it is possible that a pTyrXXPro motif in Syk is the target sequence for PLC- $\gamma$ 1. Thirty-one conserved Tyr residues are present in Syk from

different mammalian species (20, 34). Three of them, all located in the linker region joining the SH2 domains of Syk to its kinase domain, show sequence identity with the TyrXXPro motif (Fig. 7). Both Syk and Zap-70 have been implicated in the activation of PLC- $\gamma$  isoforms, and Zap-70 can substitute for Syk in restoring the anti-IgM-induced PLC- $\gamma$ 2 in the Syk-

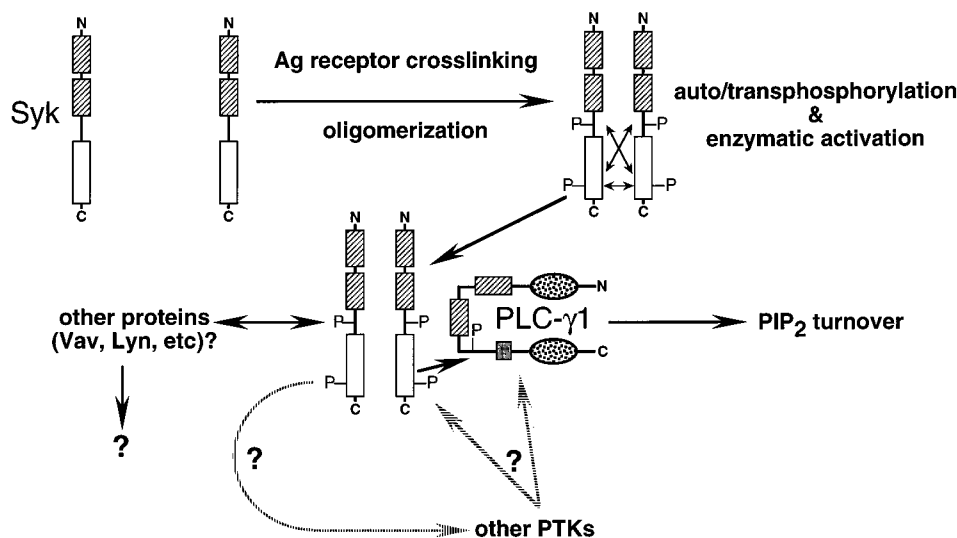

FIG. 9. Model of Syk activation and PLC- $\gamma$ 1 binding. Clustering of Syk results in its auto- or transphosphorylation and enzymatic activation. Phosphorylated sites in the linker region of Syk are then bound by PLC- $\gamma$ 1 via its SH2 domains; PLC- $\gamma$ 1 then becomes tyrosyl phosphorylated by Syk and potentially by the other Syk-regulated PTK(s). The Syk-regulated PTK(s) may also phosphorylate Syk on additional sites, while proteins other than PLC- $\gamma$ 1 may also interact with activated Syk. Abbreviations: Ag, antigen; PIP<sub>2</sub>, phosphatidylinositol 4,5-bisphosphate.

DT40 chicken B cell (17); therefore, corresponding TyrXXPro motifs may be present in Zap-70 as well. A comparison between human Syk and Zap-70 indeed revealed the presence of two such motifs at Tyr-315 and Tyr-319 of Zap-70 (Fig. 7). Site-directed mutagenesis on the mCD8-Syk chimera showed that substitution of either Tyr-296 or Tyr-348 and Tyr-352 in Syk with Phe had little effect on the enzymatic activities of these variant chimeras (Fig. 8A). However, mCD8-SykY348F, Y352F was phosphorylated slightly less than mCD8-Syk or mCD8-SykY296F (Fig. 8A), suggesting that Tyr-348 and/or Tyr-352 is among the phosphorylation sites in Syk. At the same time, the interaction between the SH2 domains of PLC- $\gamma$ 1 and mCD8-SykY348F, Y352F became almost undetectable (Fig. 8B). In contrast, substitution of Tyr-296 had virtually no effect. These results demonstrate that Tyr-348 and/or Tyr-352 in the linker region of Syk constitutes a functional domain in Syk that is responsible for the binding of PLC- $\gamma$ 1. It is still unclear if both Tyr residues are needed to mediate interaction with PLC- $\gamma$ 1. However, Tyr-352-Ala-Asp-Pro appears to give a better fit to the pTyr-hydrophobic-X-hydrophobic sequence than Tyr-348-Glu-Ser-Pro does.

The biological significance of the *in vitro* interaction between mCD8-Syk and PLC- $\gamma$ 1 SH2(C) is supported by the ability of mCD8-Syk to induce tyrosyl phosphorylation of endogenous PLC- $\gamma$ 1 in COS cells (Fig. 6). Substitution of Tyr-525 and Tyr-526 in Syk, as illustrated by mCD8-SykY525F, Y526F, produced a chimera with reduced kinase activity, greatly diminished its recognition by GST- $\gamma$ 1SH2(C) and GST- $\gamma$ 1SH2(NC) *in vitro* (Fig. 5), and eliminated tyrosyl phosphorylation of PLC- $\gamma$ 1 *in vivo* (Fig. 6). Hence, an optimal kinase activity of Syk is necessary for the induction of tyrosyl phosphorylation of PLC- $\gamma$ 1 *in vivo*. Moreover, the results obtained from the mCD8-SykY348F, Y352F chimera demonstrate that as well as the kinase activity, a functional binding site on activated Syk for PLC- $\gamma$ 1 is needed for the *in vivo* phosphorylation of PLC- $\gamma$ 1 (Fig. 8B and C).

In conclusion, our data are consistent with a model in which BCR engagement results in clustering of the receptor associated Syk. Expression of the mCD8-Syk chimera in COS cells would mimic the BCR-induced clustering. According to this

model (Fig. 9), auto- or transphosphorylation of Syk molecules occurs upon clustering, creating docking sites for PLC- $\gamma$ 1. PLC- $\gamma$ 1 would then bind to Syk through its C-terminal SH2 domain and become phosphorylated by Syk on key regulatory Tyr residues (Fig. 9). It remains to be determined if phosphorylation of PLC- $\gamma$ 1 by Syk is sufficient to fully activate the phospholipase activity of PLC- $\gamma$ 1. It is most likely that additional regulatory factors are involved, because both Syk and PLC- $\gamma$ 1 can bind to other cellular proteins in B lymphocytes including CD22 (19). Data obtained in this study also do not rule out the possibility that another PTK(s) is involved. Hence, the docking of PLC- $\gamma$ 1 to Syk may localize PLC- $\gamma$ 1 to the proximity of an undefined PTK(s) required for full PLC- $\gamma$ 1 activation (Fig. 9).

#### ACKNOWLEDGMENTS

We thank Stephen J. Klaus and Friederike Siebelt for their critical review of the manuscript.

This work was supported by NIH grants GM42508 and RR00166. Che-Leung Law is a Special Fellow of the Leukemia Society of America.

#### REFERENCES

- Arpaia, E., M. Shahar, H. Dadi, A. Cohen, and C. M. Roifman. 1994. Defective T cell receptor signaling and CD8+ thymic selection in humans lacking zap-70 kinase. *Cell* **76**:947-958.
- Berridge, M. J. 1993. Inositol trisphosphate and calcium signalling. *Nature (London)* **361**:315-325.
- Burg, D. L., M. T. Furlong, M. L. Harrison, and R. L. Geahlen. 1994. Interactions of Lyn with the antigen receptor during B cell activation. *J. Biol. Chem.* **269**:28136-28142.
- Cambier, J. C., C. M. Pleiman, and M. R. Clark. 1994. Signal transduction by the B cell antigen receptor and its coreceptors. *Annu. Rev. Immunol.* **12**:457-486.
- Carraway, K. L., III, and L. C. Cantley. 1994. A new acquaintance for erbB3 and erbB4: a role for receptor heterodimerization in growth signaling. *Cell* **78**:5-8.
- Carter, R. H., D. J. Park, S. G. Rhee, and D. T. Fearon. 1991. Tyrosine phosphorylation of phospholipase C induced by membrane immunoglobulin in B lymphocytes. *Proc. Natl. Acad. Sci. USA* **88**:2745-2749.
- Chan, A. C., M. Dalton, R. Johnson, G. H. Kong, T. Wang, R. Thoma, and T. Kurosaki. 1995. Activation of ZAP-70 kinase activity by phosphorylation

- of tyrosine 493 is required for lymphocyte antigen receptor function. *EMBO J.* **14**:2499–2508.
8. Chan, A. C., T. A. Kadlecsek, M. E. Elder, A. H. Filipovich, W. L. Kuo, M. Iwashima, T. G. Parslow, and A. Weiss. 1994. ZAP-70 deficiency in an autosomal recessive form of severe combined immunodeficiency. *Science* **264**:1599–1601.
  9. Claesson, W. L. 1994. Platelet-derived growth factor receptor signals. *J. Biol. Chem.* **269**:32023–32026.
  10. Elder, M. E., D. Lin, J. Clever, A. C. Chan, T. J. Hope, A. Weiss, and T. G. Parslow. 1994. Human severe combined immunodeficiency due to a defect in ZAP-70, a T cell tyrosine kinase. *Science* **264**:1596–1599.
  11. Hempel, W. M., R. C. Schatzman, and A. L. DeFranco. 1992. Tyrosine phosphorylation of phospholipase C-gamma 2 upon cross-linking of membrane Ig on murine B lymphocytes. *J. Immunol.* **148**:3021–3027.
  12. Hutchcroft, J. E., M. L. Harrison, and R. L. Geahlen. 1992. Association of the 72-kDa protein-tyrosine kinase PTK72 with the B cell antigen receptor. *J. Biol. Chem.* **267**:8613–8619.
  13. Hutchcroft, J. E., M. L. Harrison, and R. L. Geahlen. 1991. B lymphocyte activation is accompanied by phosphorylation of a 72-kDa protein-tyrosine kinase. *J. Biol. Chem.* **266**:14846–14849.
  14. Kim, H. K., J. W. Kim, A. Zilberstein, B. Margolis, J. G. Kim, J. Schlessinger, and S. G. Rhee. 1991. PDGF stimulation of inositol phospholipid hydrolysis requires PLC-gamma 1 phosphorylation on tyrosine residues 783 and 1254. *Cell* **65**:435–441.
  15. Kim, J. W., S. S. Sim, U. H. Kim, S. Nishibe, M. I. Wahl, G. Carpenter, and S. G. Rhee. 1990. Tyrosine residues in bovine phospholipase C-gamma phosphorylated by the epidermal growth factor receptor *in vitro*. *J. Biol. Chem.* **265**:3940–3943.
  16. Kolanus, W., C. Romeo, and B. Seed. 1993. T cell activation by clustered tyrosine kinases. *Cell* **74**:171–183.
  17. Kong, G.-H., J.-Y. Bu, T. Kurosaki, A. S. Shaw, and A. C. Chan. 1995. Reconstitution of Syk function by the ZAP-70 protein tyrosine kinase. *Immunity* **2**:485–492.
  18. Law, C.-L., K. A. Chandran, and E. A. Clark. Unpublished data.
  19. Law, C.-L., S. P. Sidorenko, K. A. Chandran, Z. Zhao, S.-H. Shen, E. H. Fischer, and E. A. Clark. CD22 associates with protein tyrosine phosphatase 1C, Syk and phospholipase C- $\gamma$ 1 upon B cell activation. *J. Exp. Med.*, in press.
  20. Law, C. L., S. P. Sidorenko, K. A. Chandran, K. E. Draves, A. C. Chan, A. Weiss, S. Edelhoff, C. M. Disteche, and E. A. Clark. 1994. Molecular cloning of human Syk. A B cell protein-tyrosine kinase associated with the surface immunoglobulin M-B cell receptor complex. *J. Biol. Chem.* **269**:12310–12319.
  21. Leprince, C., K. E. Draves, R. L. Geahlen, J. A. Ledbetter, and E. A. Clark. 1993. CD22 associates with the human surface IgM-B-cell antigen receptor complex. *Proc. Natl. Acad. Sci. USA* **90**:3236–3240.
  22. Leprince, C., K. E. Draves, J. A. Ledbetter, R. M. Torres, and E. A. Clark. 1992. Characterization of molecular components associated with surface immunoglobulin M in human B lymphocytes: presence of tyrosine and serine/threonine protein kinases. *Eur. J. Immunol.* **22**:2093–2099.
  23. Liao, F., H. S. Shin, and S. G. Rhee. 1993. *In vitro* tyrosine phosphorylation of PLC-gamma 1 and PLC-gamma 2 by src-family protein tyrosine kinases. *Biochem. Biophys. Res. Commun.* **191**:1028–1033.
  24. Malek, S. N., and S. Desiderio. 1993. SH2 domains of the protein-tyrosine kinases Blk, Lyn, and Fyn(T) bind distinct sets of phosphoproteins from B lymphocytes. *J. Biol. Chem.* **268**:22557–22565.
  25. Mohammadi, M., C. A. Dionne, W. Li, N. Li, T. Spivak, A. M. Honegger, M. Jaye, and J. Schlessinger. 1992. Point mutation in FGF receptor eliminates phosphatidylinositol hydrolysis without affecting mitogenesis. *Nature (London)* **358**:681–684.
  26. Nishibe, S., M. I. Wahl, S. S. M. Hernandez, N. K. Tonks, S. G. Rhee, and G. Carpenter. 1990. Increase of the catalytic activity of phospholipase C-gamma 1 by tyrosine phosphorylation. *Science* **250**:1253–1256.
  27. Park, D. J., H. W. Rho, and S. G. Rhee. 1991. CD3 stimulation causes phosphorylation of phospholipase C-gamma 1 on serine and tyrosine residues in a human T-cell line. *Proc. Natl. Acad. Sci. USA* **88**:5453–5456.
  28. Pascal, S. M., A. U. Singer, G. Gish, T. Yamazaki, S. E. Shoelson, T. Pawson, L. E. Kay, and K. J. D. Forman. 1994. Nuclear magnetic resonance structure of an SH2 domain of phospholipase C-gamma 1 complexed with a high affinity binding peptide. *Cell* **77**:461–472.
  29. Pawson, T. 1995. Protein modules and signalling networks. *Nature (London)* **373**:573–580.
  30. Pleiman, C. M., M. R. Clark, L. K. Gauen, S. Winitz, K. M. Coggeshall, G. L. Johnson, A. S. Shaw, and J. C. Cambier. 1993. Mapping of sites on the Src family protein tyrosine kinases p55blk, p59fyn, and p56lyn which interact with the effector molecules phospholipase C-gamma 2, microtubule-associated protein kinase, GTPase-activating protein, and phosphatidylinositol 3-kinase. *Mol. Cell. Biol.* **13**:5877–5887.
  31. Pleiman, C. M., D. D'Ambrosio, and J. C. Cambier. 1994. The B-cell antigen receptor complex: structure and signal transduction. *Immunol. Today* **15**:393–399.
  32. Rivera, V. M., and J. S. Brugge. 1995. Clustering of Syk is sufficient to induce tyrosine phosphorylation and release of allergic mediators from rat basophilic leukemia cells. *Mol. Cell. Biol.* **15**:1582–1590.
  33. Rotin, D., B. Margolis, M. Mohammadi, R. J. Daly, G. Daum, N. Li, E. H. Fischer, W. H. Burgess, A. Ullrich, and J. Schlessinger. 1992. SH2 domains prevent tyrosine dephosphorylation of the EGF receptor: identification of Tyr992 as the high-affinity binding site for SH2 domains of phospholipase C gamma. *EMBO J.* **11**:559–567.
  34. Rowley, R. B., J. B. Bolen, and J. Fargnoli. 1995. Molecular cloning of rodent p72Syk. Evidence of alternative mRNA splicing. *J. Biol. Chem.* **270**:12659–12664.
  35. Schieven, G. L., J. M. Kiriara, D. L. Burg, R. L. Geahlen, and J. A. Ledbetter. 1993. p72syk tyrosine kinase is activated by oxidizing conditions that induce lymphocyte tyrosine phosphorylation and Ca<sup>2+</sup> signals. *J. Biol. Chem.* **268**:16688–16692.
  36. Schieven, G. L., J. M. Kiriara, D. E. Myers, J. A. Ledbetter, and F. M. Uckun. 1993. Reactive oxygen intermediates activate NF-kappa B in a tyrosine kinase-dependent mechanism and in combination with vanadate activate the p56lck and p59fyn tyrosine kinases in human lymphocytes. *Blood* **82**:1212–1220.
  37. Schieven, G. L., R. S. Mittler, S. G. Nadler, J. M. Kiriara, J. B. Bolen, S. B. Kanner, and J. A. Ledbetter. 1994. ZAP-70 tyrosine kinase, CD45, and T cell receptor involvement in UV- and H<sub>2</sub>O<sub>2</sub>-induced T cell signal transduction. *J. Biol. Chem.* **269**:20718–20726.
  38. Sidorenko, S. P., C. L. Law, K. A. Chandran, and E. A. Clark. 1995. Human spleen tyrosine kinase p72Syk associates with the Src-family kinase p53/56Lyn and a 120-kDa phosphoprotein. *Proc. Natl. Acad. Sci. USA* **92**:359–363.
  39. Sillman, A. L., and J. G. Monroe. 1995. Association of p72syk with the src homology-2 (SH2) domains of PLC-gamma 1 in B lymphocytes. *J. Biol. Chem.* **270**:11806–11811.
  40. Songyang, Z., S. E. Shoelson, M. Chaudhuri, G. Gish, T. Pawson, W. G. Haser, F. King, T. Roberts, S. Ratnoffsky, R. J. Lechleider, B. G. Neel, R. B. Birge, J. E. Fafardo, M. M. Chou, J. Hanafusa, B. Schaffhausen, and L. C. Cantley. 1993. SH2 domains recognize specific phosphopeptide sequences. *Cell* **72**:767–778.
  41. Takata, M., H. Sabe, A. Hata, T. Inazu, Y. Homma, T. Nukada, H. Yamamura, and T. Kurosaki. 1994. Tyrosine kinases Lyn and Syk regulate B cell receptor-coupled Ca<sup>2+</sup> mobilization through distinct pathways. *EMBO J.* **13**:1341–1349.
  42. Valius, M., C. Bazenet, and A. Kazlauskas. 1993. Tyrosines 1021 and 1009 are phosphorylation sites in the carboxy terminus of the platelet-derived growth factor receptor beta subunit and are required for binding of phospholipase C gamma and a 64-kilodalton protein, respectively. *Mol. Cell. Biol.* **13**:133–143.
  43. Valius, M., and A. Kazlauskas. 1993. Phospholipase C-gamma 1 and phosphatidylinositol 3 kinase are the downstream mediators of the PDGF receptor's mitogenic signal. *Cell* **73**:321–334.
  44. Wahl, M. I., S. Nishibe, J. W. Kim, H. Kim, S. G. Rhee, and G. Carpenter. 1990. Identification of two epidermal growth factor-sensitive tyrosine phosphorylation sites of phospholipase C-gamma in intact HSC-1 cells. *J. Biol. Chem.* **265**:3944–3948.
  45. Zhu, G., S. J. Decker, and A. R. Saltiel. 1992. Direct analysis of the binding of Src-homology 2 domains of phospholipase C to the activated epidermal growth factor receptor. *Proc. Natl. Acad. Sci. USA* **89**:9559–9563.