

Human Dendritic Cell-Specific Intercellular Adhesion Molecule-Grabbing Nonintegrin (CD209) Is a Receptor for *Yersinia pestis* That Promotes Phagocytosis by Dendritic Cells[∇]

Pei Zhang,¹ Mikael Skurnik,² Shu-Sheng Zhang,¹ Olivier Schwartz,³ Ramaswamy Kalyanasundaram,¹ Silvia Bulgheresi,⁴ Johnny J. He,⁵ John D. Klena,⁶ B. Joseph Hinnebusch,⁷ and Tie Chen^{1*}

Department of Biomedical Sciences, College of Medicine, University of Illinois at Chicago (UIC), 1601 Parkview Avenue, Rockford, Illinois 61107¹; Department of Bacteriology and Immunology, Haartman Institute, University of Helsinki and Helsinki University Central Hospital Laboratory Diagnostics, Helsinki 00014, Finland²; Virus and Immunity Group in the Department of Virology, Institut Pasteur, Paris, France³; Faculty of Life Sciences, Department of Marine Biology, University of Vienna, Vienna, Austria⁴; Department of Microbiology and Immunology, Indiana University School of Medicine, Indianapolis, Indiana 46202⁵; School of Biological Sciences, University of Canterbury, Christchurch, New Zealand⁶; and Laboratory of Zoonotic Pathogens, Rocky Mountain Laboratories, National Institute of Allergy and Infectious Diseases, National Institutes of Health, 903 South 4th Street, Hamilton, Montana 59840⁷

Received 11 September 2007/Returned for modification 22 October 2007/Accepted 29 January 2008

***Yersinia pestis* is the etiologic agent of bubonic and pneumonic plagues. It is speculated that *Y. pestis* hijacks antigen-presenting cells (APCs), such as dendritic cells (DCs) and alveolar macrophages, in order to be delivered to lymph nodes. However, how APCs initially capture the bacterium remains uncharacterized. It is well known that HIV-1 uses human DC-specific intercellular adhesion molecule-grabbing nonintegrin (DC-SIGN) (CD209) receptor, expressed by APCs, to be captured and delivered to target cell, such as CD4⁺ lymphocytes. Several gram-negative bacteria utilize their core lipopolysaccharides (LPS) as ligands to interact with the human DC-SIGN. Therefore, it is possible that *Y. pestis*, whose core LPS is naturally exposed, might exploit DC-SIGN to invade APCs. We demonstrate in this study that *Y. pestis* directly interacts with DC-SIGN and invades both DCs and alveolar macrophages. In contrast, when engineered to cover the core LPS, *Y. pestis* loses its ability to invade DCs, alveolar macrophages, and DC-SIGN-expressing transfectants. The interaction between *Y. pestis* and human DCs can be reduced by a combination treatment with anti-CD209 and anti-CD207 antibodies. This study shows that human DC-SIGN is a receptor for *Y. pestis* that promotes phagocytosis by DCs in vitro.**

The genus *Yersinia* belongs to the gram-negative bacteria and is composed of 11 species (27, 57). Three *Yersinia* species are pathogenic to humans and animals. *Yersinia pseudotuberculosis* and *Yersinia enterocolitica* cause mild enteric diseases and are mainly transmitted by contaminated food and surface water. However, the etiologic agent of bubonic and pneumonic plagues is *Yersinia pestis*, the most virulent species. *Y. pestis* is also a young pathogen, directly evolved from *Y. pseudotuberculosis* within the last 10,000 to 20,000 years (1, 2).

All three pathogenic *Yersinia* species share a virulence plasmid, pCD1 (pYV), which is essential for pathogenic processes (8, 44). This plasmid encodes a type III secretion system, including LcrV (low-calcium response V, or V antigen) (16), YadA (a surface-expressed adherence molecule; however, *yadA* is a pseudogene in *Y. pestis*) (47, 51), and a number of cytotoxins and effectors that inhibit bacterial phagocytosis and processes of innate immunity (58). *Y. pestis* harbors two additional plasmids, pPCP1 (9.6 kb), which encodes the plasminogen activator (Pla), and pMT1 (pFra) (102 kb), which encodes

the F1 capsule protein and a phospholipase D (Ymt). The products of these genes are necessary for tissue invasion (29) and infection of the plague flea vector (24, 50). Capsule formation by *Y. pestis* has been reported to confer antiphagocytic ability (18, 59). Recent studies further confirmed the important roles of pPCP1 in the virulence of bubonic and pneumonic plagues (36, 50). However, despite extensive studies characterizing plasmid-encoded virulence determinants, the presence of pPCP1 and pMT1 does not account for the remarkable increase in virulence detected in *Y. pestis*. In fact, *Y. pseudotuberculosis*, even when transformed with additional virulence factors, such as the pPCP plasmid of *Y. pestis*, does not cause plague-like disease after subdermal injection (35).

Two other chromosomally located invasion genes, *inv* and *ail*, have been identified as important for the interaction of enteropathogenic *Yersinia* species with host cells (6, 25, 26, 40). Although *Y. pestis* does not express invasins, whose functions are probably replaced by a flea bite, Ail-like proteins have been reported (4, 34).

Another well-documented, but often neglected, virulence factor is the lipopolysaccharide (LPS), which plays a major role in the pathogenicity of gram-negative bacterial pathogens, such as *Escherichia coli*, *Shigella*, *Klebsiella*, *Yersinia*, and *Salmonella*, promoting toxicity and resistance to serum killing and phagocytosis (5, 10, 17, 41, 42, 48). LPS generally consists of

* Corresponding author. Mailing address: Department of Biomedical Sciences, College of Medicine, University of Illinois at Chicago (UIC), 1601 Parkview Avenue, Rockford, IL 61107. Phone: (815) 395-5893. Fax: (815) 395-5666. E-mail: tiechen@uic.edu.

[∇] Published ahead of print on 19 February 2008.

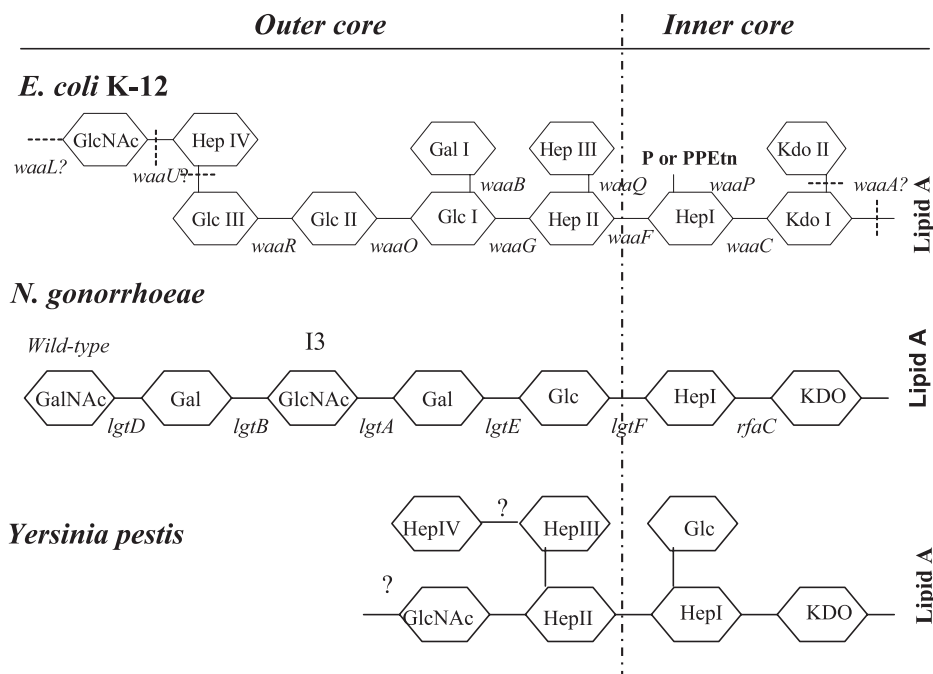

FIG. 1. Structures of inner-core and outer-core regions of the LPS or LOS of *Y. pestis*, *E. coli* K-12, and *N. gonorrhoeae* and the genes involved in their synthesis. Genes involved in the biosynthesis of core LPS are shown at their approximate sites of action (solid lines). The sites that are variably substituted or still under investigation are indicated by dashed lines. GlcNAc, *N*-acetylglucosamine; GalNAc, *N*-acetylgalactosamine; Glc, glucose; Hep, heptose; Gal, galactose; P, phosphate; PPEtn, phosphoethanolamine; KDO, 2-keto-3-deoxyoctonate; PEA, phosphoethanolamine. It should be noted that *Y. pestis*, *E. coli* K-12, and *N. gonorrhoeae* do not naturally possess an O antigen.

three structural regions: (i) the lipid A backbone, (ii) an oligosaccharide core (core LPS), and (iii) the somatic O polysaccharide outer region (also called O antigen, O-specific antigen, or O-specific side chain) (Fig. 1). Core LPS is divided into inner and outer domains (Fig. 1). Strains of *Y. pestis* do not contain an O antigen (45), and therefore, the shortened LPS is also referred to as lipooligosaccharide (LOS). Gram-negative bacteria are classified as smooth or rough based on the presence or lack of the O antigen, respectively.

Antigen-presenting cells (APCs) have been shown to be positioned to interact with *Y. pestis* immediately upon injection of the bacterium by an infected flea (58). It is generally accepted that APCs deliver *Y. pestis* to lymph nodes. Dendritic cells (DCs) are APCs and express a C-type lectin called DC-specific intercellular adhesion molecule-grabbing nonintegrin (DC-SIGN) (CD209), an innate immune receptor (56) that can interact with several bacterial species (55, 56). DC-SIGN is also expressed in certain types of macrophages (23), including human alveolar macrophages (54). This model is reminiscent of how human immunodeficiency virus type 1 (HIV-1) targets APCs. It is well established that HIV-1 hijacks DC-SIGN so as to be captured and trafficked to target cells, such as CD4 lymphocytes (19, 21, 39).

Recently, we showed that DC-SIGN is a receptor for the core LPSs of several gram-negative bacterial strains, promoting bacterial adherence and phagocytosis (32, 61, 62). In this study, we explore the model that (i) after *Y. pestis* overcomes the first line of host defense, such as the skin via a flea bite, it encounters secondary host defense systems, such as macrophages and DCs (Langerhans cells in the skin) (38) or alveolar

macrophages through aspiration, and (ii) APCs capture *Y. pestis* through a core LPS–DC-SIGN interaction.

MATERIALS AND METHODS

Bacterial strains. (i) *E. coli*. *E. coli* strain K-12 CS180 contains core LPS but lacks O antigen (49). CS1861 is the strain of CS180 harboring pSS37, a plasmid containing all of the genes necessary for the expression of the *Shigella dysenteriae* 1 O antigen (31, 33, 49) (Fig. 1). *E. coli* strains were cultured on Luria-Bertani medium (LB) supplemented with 1.5% agar at 37°C overnight.

(ii) *Y. pseudotuberculosis*. *Y. pseudotuberculosis* Y1 is a serotype O:1a strain lacking the virulence plasmid (pYV) and expression of the Ail protein (unpublished data). The strain was from CDC and was once used as a control strain for invasion (11).

(iii) *Y. pestis*. All strains of *Y. pestis* used in this study are derived from the KIM strain (20). The O antigen-expressing KIM-6/pAY100.1 was constructed by transformation of the pAY100.1 plasmid from strain KIM-D27/pAY100.1, which expresses the O antigen from *Y. enterocolitica* serotype O:3 (43). The strains were cultured on gonococcus (GC)-based plates (Difco, Sparks, MD) supplemented with 1% hemoglobin (USB Co., Cleveland, OH).

Due to concerns about biosafety, all *Yersinia* strains used in this study were virulence plasmid-cured and/or Pgm-negative strains, selected using a combination of magnesium oxalate and Congo red selection methods (46).

(iv) *N. gonorrhoeae*. *Neisseria gonorrhoeae* strain F62 was cultured on GC-based-plates (Difco, Sparks, MD) supplemented with 1% IsovitaleX and maintained as previously described (12, 14). *N. gonorrhoeae* is the etiologic agent for gonorrhea, a sexually transmitted disease. An isogenic mutant, I3, derived from wild-type F62, contains a mutation within *lgtB* (*lgtB* mutant) and binds to the DC-SIGN receptor (61, 62). This mutant was a gift from E. C. Gotschlich at Rockefeller University (Fig. 1) (22). For *N. gonorrhoeae*, only Opa⁻ (opacity protein-negative) and pilus⁻ variants were used.

Cellular-biology reagents. Anti-CD209 and -CD207 monoclonal antibodies specific for human DC-SIGN and human langerin, respectively, were purchased from Pharmingen (San Diego, CA) and R&D Systems (Minneapolis, MN). YTH71.3, an antibody that recognizes CEACAM1 (CD66a), CEACAM6 (CD66c), and CEACAM3 (CD66d), was purchased from Roche (Indianapolis,

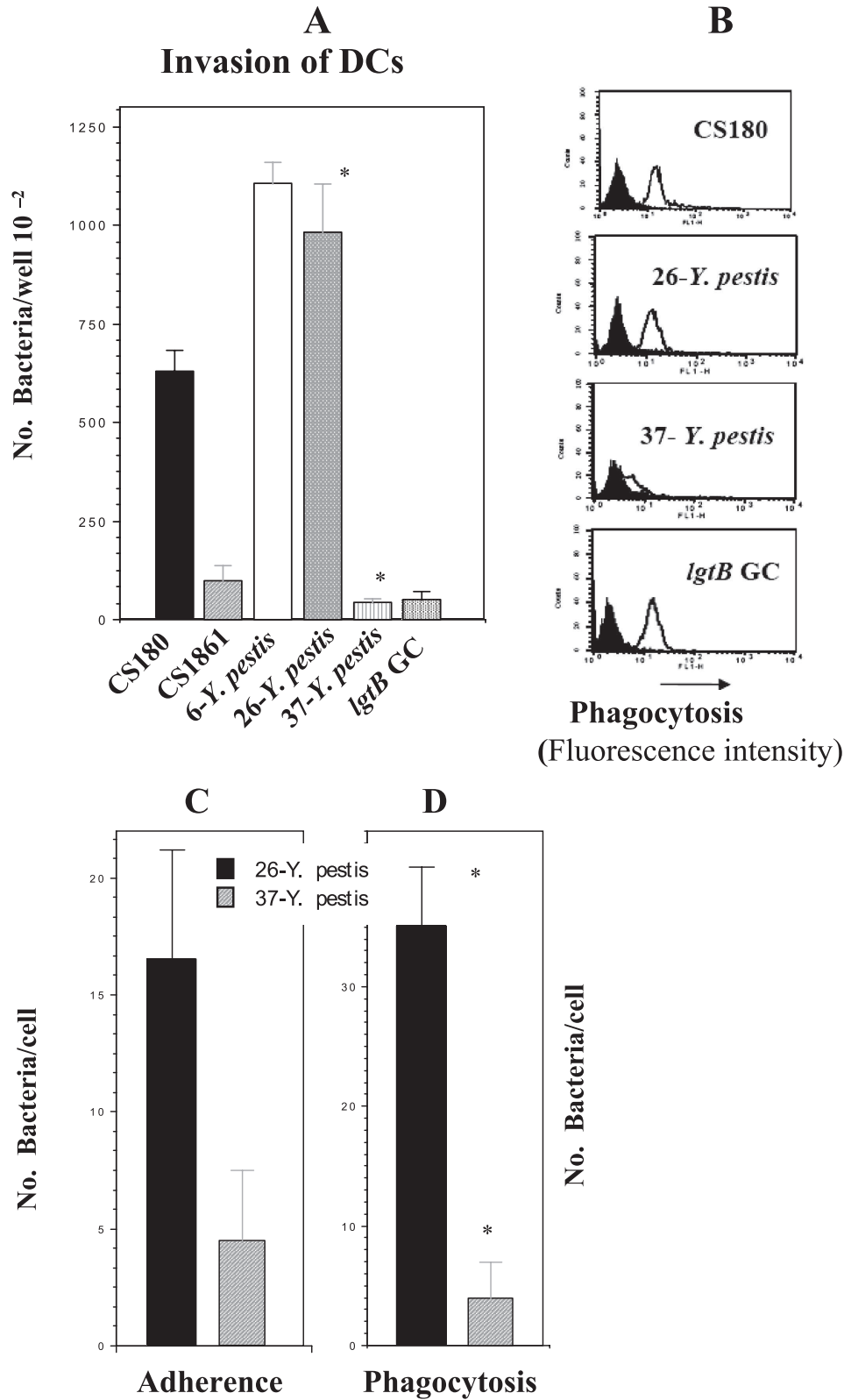

FIG. 2. 26- or 6-*Y. pestis* invades DCs. Gentamicin protection-, flow cytometry-, and fluorescence microscopy-based assays were used to determine the DC invasion rates of *Y. pestis*. *E. coli* strain K-12 (CS180 and CS1861) and the *N. gonorrhoeae* F62 *lgtB* mutant were utilized as controls, whose invasive nature has been reported recently (32, 61, 62). (A) Data from the gentamicin protection assay. (B) Data from flow cytometry. Labeled and unlabeled bacteria are shown in open and filled curves, respectively. (C and D) Adherence (C) and phagocytosis (D) data acquired from fluorescence microscopy assays. (A and D) *, $P < 0.001$, calculated by Student's *t* test, in the comparison of the invasion of DCs by 26- and 37-*Y. pestis*. *n* was nine samples for each test. The error bars indicate standard errors.

IN). Anti-*Y. pestis* polyclonal antiserum was generated from rabbits challenged with KIM-6 cultured at 21°C (28). Fluorescein isothiocyanate (FITC)- and phycoerythrin (PE)-conjugated anti-rabbit immunoglobulin G (whole-molecule) antibodies produced in goats were purchased from Sigma (St. Louis, MO). Mouse anti-F antigen monoclonal antibody and the anti-mouse antibodies conjugated with FITC and PE were purchased from eBiomedical Sciences (San Diego, CA).

Mannan, the ligand antagonist of human mannose receptor, was purchased from Sigma (St. Louis, MO).

Mermaid is a DC-SIGN-like molecule expressed by the marine nematode *Laxus oneistus*. The carbohydrate recognition domain of Mermaid shares both structural and functional similarity with that of DC-SIGN as described previously (9). A recombinant form of Mermaid (His-Mermaid) was expressed and purified as described previously (9).

Preparation of human DCs. Peripheral blood mononuclear cells (PBMC) were isolated from buffy coats obtained from human blood donors by density gradient centrifugation over Ficoll-Paque^{plus} (1.077 g/ml; Pharmacia, Piscataway, NJ). Blood was loaded in a 1:1 (vol/vol) ratio on Ficoll and centrifuged without braking for 30 min. The PBMC were washed four times with phosphate-buffered saline (PBS), and monocytes were purified from the PBMC using CD14 microbeads (Miltenyi Biotec, Auburn, CA) as previously described (37). To increase purity, the cells were passed over a second CD14 microbead column. The final purity of the isolated monocytes was >98% as assessed by labeling with CD14-FITC antibody (Caltag, Carlsbad, CA) and flow cytometric analysis. Purified CD14-positive (CD14⁺) monocytes (5×10^5 cells/ml) were cultured for 6 days to promote differentiation of immature monocyte-derived DCs in culture medium consisting of RPMI 1640 (BioWhittaker, Walkersville, MD), 10% heat-inactivated fetal bovine serum (HyClone, Logan, UT), 100 U/ml penicillin, and 100 µg/ml streptomycin in the presence of 20 ng/ml recombinant human granulocyte-macrophage colony-stimulating factor (Immunex, Seattle, WA) and 10 ng/ml recombinant human interleukin 4 (Peprotech, Rock Hill, NJ). The DCs derived from these cultured monocytes display typical dendrites, and in mixed lymphocyte cultures, they promote activation of alloreactive T cells. The phenotype of these cells is HLA-DR⁺ CD1a⁺ CD86⁺ CD40⁺ CD14⁻ (37). Upon LPS stimulation, these DCs express CD83 (63, 64). We have utilized this protocol for identification of DC-SIGN as a receptor for the core LPSs of several gram-negative bacteria and to explore how *N. gonorrhoeae* enhances HIV infection (32, 60, 61).

Human alveolar macrophage isolation and treatment. Bronchoalveolar lavage (BAL) cells were collected from volunteers following a protocol described recently by Tailleux et al. (54). Acquisition of the BAL cells was approved by the Institutional Review Board and Study Committees at the College of Medicine—Rockford, University of Illinois. The collected BAL cells were washed and cultured in RPMI 1640 (BioWhittaker, Walkersville, MD) supplemented with 10% heat-inactivated fetal calf serum (FCS) (HyClone, Logan, UT), 2 mM L-glutamine, and antibiotics in a 96-well plate for 3 h at 37°C before nonadherent cells were removed. Half of the cells were treated with interleukin 4 (10 ng/ml; Peprotech, Rock Hill, NJ), tumor necrosis factor alpha (50 ng/ml; Peprotech, Rock Hill, NJ), and *E. coli*-derived LPS (100 ng/ml; Sigma, St. Louis, MO). Invasion experiments followed, after the two sets of cells were placed at 37°C with 5% CO₂ for 2 days.

Cultured cell lines. HeLa-DC-SIGN cells were generated by transfecting HeLa cells with human DC-SIGN cDNA, followed by selection for stable surface DC-SIGN expression as originally described (52). The cell lines were recently used for identification of core LPSs from several gram-negative bacteria as ligands for the DC-SIGN receptor (32, 61, 62).

Adherence and phagocytosis assays. The assays for adherence and phagocytosis have been described previously (12, 14). Briefly, host cells (HeLa cells, DCs, and alveolar macrophages) were plated in 24- or 96-well plates. The cells were suspended in RPMI with 2% FCS at a concentration of 4×10^5 /ml. One-half milliliter each of these cell suspensions was added to 24-well plates, and after the addition of 50 µl of bacterial suspensions at a concentration of 1×10^7 CFU/ml, the cells were allowed to incubate for 2.5 h (2 h for DCs and alveolar macrophages) at 37°C in the presence of 5% CO₂. The cell monolayers were then washed three times with PBS. The number of associated bacteria (adherent and internalized) per cell was quantified by washing the cells three times with RPMI containing 2% FCS and plating the culture after the cells were lysed by 0.5% saponin (Calbiochem Corp., San Diego, CA).

To determine the internalization of bacteria, gentamicin, which kills extracellular bacteria but cannot penetrate into host cells, was added to each well to a final concentration of 100 µg/ml, and the cultures were incubated for 60 min. The cells were washed twice to remove the antibiotics (for DCs, cytospin is necessary during the washing, since DCs do not attach to plastic wells). Then, the cells were suspended in PBS containing 0.5% saponin, diluted, and plated on GC or LB

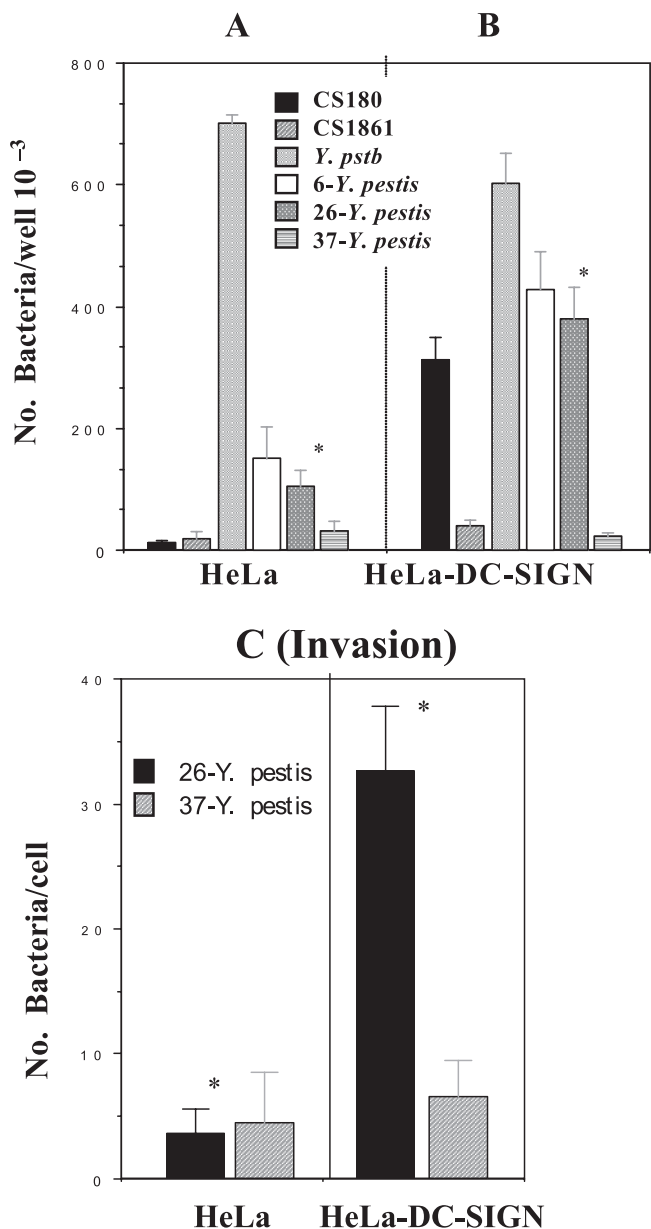

FIG. 3. HeLa-DC-SIGN cells phagocytose 26-*Y. pestis*. (A and B) The phagocytoses of two sets of bacteria, *E. coli* K-12 (CS180 and CS1861) and 6-, 26-, and 37-*Y. pestis*, with HeLa (A) and HeLa-DC-SIGN cells (B) were performed by incubating the cell lines for 2.5 h with the indicated bacterial strains and by killing the extracellular bacteria with 100 µg/ml (final concentration) of gentamicin as described in Materials and Methods. The number of phagocytosed bacteria was determined by counting CFU recovered following gentamicin treatment. (C) Results from fluorescence microscopy assay. Only data for *Y. pestis* are shown. *, $P < 0.001$, based on Student's *t* test comparing the interaction of HeLa-DC-SIGN cells with 26-*Y. pestis* to the interaction of HeLa with the same bacterium. *n* was nine samples for each test. The error bars indicate standard errors.

plates. The level of internalization of bacteria in these host cells was calculated by determining the number of CFU recovered from lysed cells. All experiments were performed in triplicate, and data were expressed as means \pm standard errors. Statistical significance was calculated using Student's *t* test.

For the inhibition assay, reagents were added 20 min prior to the addition of bacteria at the following concentrations: anti-DC-SIGN antibody, 5 µg/ml; DC-

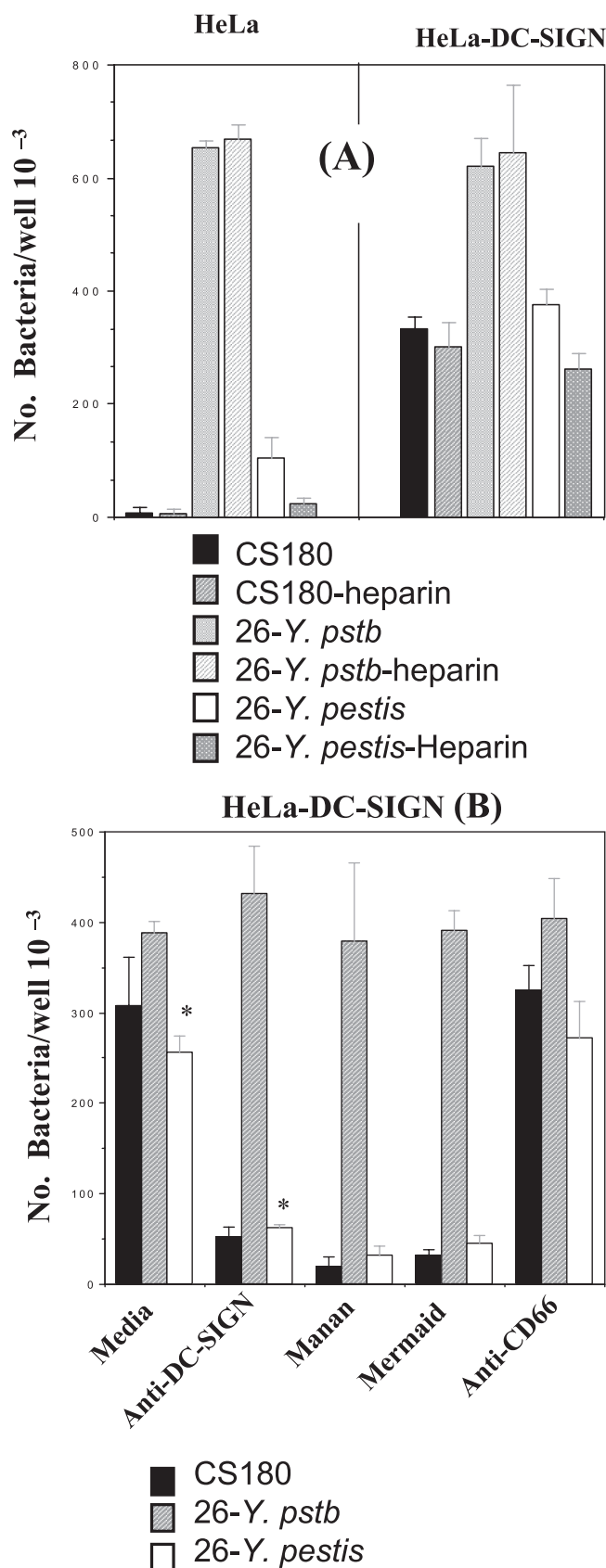

FIG. 4. DC-SIGN-mediated phagocytosis of *Y. pestis* is inhibited by heparin, anti-DC-SIGN antibody, mannan, and DC-SIGN-like Mer-

maid. (A) *E. coli* K-12 CS180, *Y. pseudotuberculosis* serotype O:1a, and 26-*Y. pestis* were incubated with HeLa and HeLa-DC-SIGN cells for 2.5 h in the presence or absence of heparin (30 $\mu\text{g/ml}$). (B) 26-*Y. pestis* was incubated with HeLa-DC-SIGN cells for 2.5 h in the presence or absence of anti-CD66 (5 $\mu\text{g/ml}$) and DC-SIGN (5 $\mu\text{g/ml}$), mannan (500 $\mu\text{g/ml}$), and DC-SIGN-like protein (His-Mermaid; 10 $\mu\text{g/ml}$). All reagents were added to the media for 20 min before the addition of bacteria. Heparin (30 $\mu\text{g/ml}$) was added to every sample in order to eliminate the non-DC-SIGN-specific interaction. The concentration of each reagent used in the experiment was based on previously published data (32, 61, 62). The phagocytosis rate of *Y. pestis* was evaluated by the recovery of bacteria from gentamicin protection. *E. coli* K-12 CS180 and *Y. pseudotuberculosis* serotype O:1a were control strains. In addition, only half the number of *Y. pseudotuberculosis* cells were added to the HeLa-DC-SIGN sample in order to better compare the effects of these reagents among the three strains. (A) *Y. pseudotuberculosis* promotes effective internalization into HeLa cells. *, $P < 0.001$, based on Student's *t* test comparing the interaction of HeLa-DC-SIGN cells with 26-*Y. pestis* in the presence of anti-DC-SIGN antibody to the interaction without the presence of antibody. *n* was nine samples for each test. The error bars indicate standard errors.

maid. (A) *E. coli* K-12 CS180, *Y. pseudotuberculosis* serotype O:1a, and 26-*Y. pestis* were incubated with HeLa and HeLa-DC-SIGN cells for 2.5 h in the presence or absence of heparin (30 $\mu\text{g/ml}$). (B) 26-*Y. pestis* was incubated with HeLa-DC-SIGN cells for 2.5 h in the presence or absence of anti-CD66 (5 $\mu\text{g/ml}$) and DC-SIGN (5 $\mu\text{g/ml}$), mannan (500 $\mu\text{g/ml}$), and DC-SIGN-like protein (His-Mermaid; 10 $\mu\text{g/ml}$). All reagents were added to the media for 20 min before the addition of bacteria. Heparin (30 $\mu\text{g/ml}$) was added to every sample in order to eliminate the non-DC-SIGN-specific interaction. The concentration of each reagent used in the experiment was based on previously published data (32, 61, 62). The phagocytosis rate of *Y. pestis* was evaluated by the recovery of bacteria from gentamicin protection. *E. coli* K-12 CS180 and *Y. pseudotuberculosis* serotype O:1a were control strains. In addition, only half the number of *Y. pseudotuberculosis* cells were added to the HeLa-DC-SIGN sample in order to better compare the effects of these reagents among the three strains. (A) *Y. pseudotuberculosis* promotes effective internalization into HeLa cells. *, $P < 0.001$, based on Student's *t* test comparing the interaction of HeLa-DC-SIGN cells with 26-*Y. pestis* in the presence of anti-DC-SIGN antibody to the interaction without the presence of antibody. *n* was nine samples for each test. The error bars indicate standard errors.

Statistical significance was mainly calculated using Statview, a statistical program from SAS Institute, North Carolina. Because all statistical analyses described were single comparisons, only Student's *t* test was utilized.

Determination of phagocytosis by flow cytometry. The following method was used to supplement the survival-based phagocytosis assay described above (61). The measurement of the phagocytosis rate of bacteria by DCs was adapted as follows. Briefly, bacteria were suspended in RPMI medium containing 5- and 6-carboxyfluorescein diacetate, succinimidyl ester (Molecular Probes, Eugene, OR), for 40 min and washed twice with RPMI to remove the excess dye. Labeled bacteria were added to the DC cultures for 2 h. The cell cultures were washed twice to remove unbound bacteria. The DCs plus associated bacteria were fixed with 2% paraformaldehyde. Before flow cytometry, a 1:10 dilution of trypan blue (0.4%; Sigma, St. Louis, MO) was added to the fixed cell cultures, and the mixture was incubated at ambient temperature for 10 min (61) to quench the fluorescence from extracellularly labeled bacteria. Trypan blue blocks fluorescence but cannot penetrate host cells; therefore, fluorescence from internalized bacteria is not influenced by the addition of trypan blue. The rate of bacterial internalization was determined by comparing the percentage of fluorescence-positive DCs with that of unlabeled DCs.

Microscopic assay to determine cellular interactions. Purified DCs and HeLa-DC-SIGN cells were plated in 24-well plates, with each well containing a coverslip. The host cells were infected with *Y. pestis* following the same procedures described for the interaction assays. After a 2-h incubation, *Y. pestis*-infected DCs and HeLa-DC-SIGN cells were washed twice with PBS with cytospin and fixed with 2% paraformaldehyde in PBS. Infected DCs on the coverslips were stained with anti-*Y. pestis* antiserum from rabbits for 45 min. Subsequently, FITC-anti-rabbit antibody (the second antibody) was used to label the extracellular bacteria (green). The coverslips were treated with PBS containing 0.5% Triton X-100 for 10 min to make holes in the membranes of the DCs and HeLa-DC-SIGN cells. After the cells were washed three times with PBS, the same anti-*Y. pestis* antiserum was added for 45 min to stain the intracellular *Y. pestis* cells. Following three washes, the PE-conjugated anti-rabbit antibody was added to label the intracellular bacteria (red). The numbers of adherent (green) and internalized (red) bacteria per host cell were determined by using a fluorescence microscope and counting the bacteria associated with 100 host cells on coverslips. It should be noted that *Y. pestis* cultured at 37°C did not stain well with this rabbit antiserum, and therefore, the anti-F antigen monoclonal antibody was used instead of anti-*Y. pestis* polyclonal antiserum. Corresponding anti-mouse immunoglobulin G secondary antibodies conjugated with FITC and PE were used.

maid. (A) *E. coli* K-12 CS180, *Y. pseudotuberculosis* serotype O:1a, and 26-*Y. pestis* were incubated with HeLa and HeLa-DC-SIGN cells for 2.5 h in the presence or absence of heparin (30 $\mu\text{g/ml}$). (B) 26-*Y. pestis* was incubated with HeLa-DC-SIGN cells for 2.5 h in the presence or absence of anti-CD66 (5 $\mu\text{g/ml}$) and DC-SIGN (5 $\mu\text{g/ml}$), mannan (500 $\mu\text{g/ml}$), and DC-SIGN-like protein (His-Mermaid; 10 $\mu\text{g/ml}$). All reagents were added to the media for 20 min before the addition of bacteria. Heparin (30 $\mu\text{g/ml}$) was added to every sample in order to eliminate the non-DC-SIGN-specific interaction. The concentration of each reagent used in the experiment was based on previously published data (32, 61, 62). The phagocytosis rate of *Y. pestis* was evaluated by the recovery of bacteria from gentamicin protection. *E. coli* K-12 CS180 and *Y. pseudotuberculosis* serotype O:1a were control strains. In addition, only half the number of *Y. pseudotuberculosis* cells were added to the HeLa-DC-SIGN sample in order to better compare the effects of these reagents among the three strains. (A) *Y. pseudotuberculosis* promotes effective internalization into HeLa cells. *, $P < 0.001$, based on Student's *t* test comparing the interaction of HeLa-DC-SIGN cells with 26-*Y. pestis* in the presence of anti-DC-SIGN antibody to the interaction without the presence of antibody. *n* was nine samples for each test. The error bars indicate standard errors.

RESULTS

***Y. pestis* cultured at 26°C or 6°C, but not 37°C, invades and survives inside DCs.** We examined the ability of *Y. pestis* KIM-6 cultured at 37°C, 26°C, and 6°C to invade DCs (*Y. pestis* is capable of replication at 6°C, although the generation time is significantly increased). (*Y. pestis* cells cultured at 37°C, 26°C, and 6°C are referred to as 37-*Y. pestis*, 26-*Y. pestis*, and 6-*Y. pestis*, respectively, hereafter.) We used *E. coli* strains K-12 CS180 (a strain with the core LPS exposed) and CS1861 (CS180 expressing an O antigen) as controls. We have used this pair of strains to demonstrate that exposure of the core LPS of *E. coli* is essential to initiate core LPS-DC interaction (32, 61). The *N. gonorrhoeae* F62 *lgtB* mutant was also used as a control. We and others have recently shown that the *Neisseria lgtB* mutant invades DCs (53, 61).

The results from both a gentamicin protection assay (Fig. 2A) and flow cytometry (Fig. 2B) show that 6- and 26-*Y. pestis*, but not 37-*Y. pestis*, invades DCs. 37-*Y. pestis* expresses the F1 capsule, which most likely blocks or inhibits the interaction between the potential receptors and *Y. pestis*. These results were also confirmed by microscopic approaches (Fig. 2C and D). A spontaneous and undefined F1⁻ mutant of KIM5 recovered its ability to invade DCs at all temperatures, supporting this conclusion (data not shown). An important issue that should be recognized is that the gentamicin killing assay is dependent on bacterial survival inside host cells. As the flow cytometric data show, *Y. pestis*, *E. coli*, and *N. gonorrhoeae* promote similar levels of internalization, but *Y. pestis* was recovered at a higher rate than *E. coli*, suggesting that *Y. pestis* survives inside DCs very well. In contrast, the recovery rate for *N. gonorrhoeae* was very low, similar to the previously described results (61).

Temperature regulates the interaction of *Y. pestis* with DC-SIGN. The DC-SIGN receptor on DCs is responsible for interaction with the core LPSs of several gram-negative bacteria (32, 61, 62). To investigate if DC-SIGN is responsible for the interaction of DCs with *Y. pestis*, a stably transfected DC-SIGN HeLa cell line (HeLa-DC-SIGN) was tested for its ability to phagocytose 26- and 6-*Y. pestis*. Again, *E. coli* CS180 and CS1861 were used as controls for core LPS involvement. *Y. pseudotuberculosis* was also used as a control, since it may express three invasion factors—invasin, YadA, and Ail—and invade most epithelial cells (6, 25, 40).

26- and 6-*Y. pestis* promotes a typical and strong DC-SIGN-mediated invasion reaction (Fig. 3B and C). There is no interaction of HeLa and HeLa-DC-SIGN cells with 37-*Y. pestis*, probably due to F1 capsule formation. Finally, Fig. 3 also shows that 26- and 6-*Y. pestis* can interact with HeLa cells (Fig. 3A), which is independent from the interaction with DC-SIGN. We address this phenomenon below and in the Discussion. In conclusion, *Y. pestis* interacts with the DC-SIGN receptor directly.

Inhibition of the *Y. pestis*-host cell interaction by heparin, anti-DC-SIGN antibody, mannan, and a DC-SIGN-like molecule. Figure 3 shows that 26- and 6-*Y. pestis* can also interact with HeLa cells, which is independent from the interaction with DC-SIGN. Our preliminary data showed that this DC-SIGN-independent interaction is in part mediated by cell surface heparan sulfate proteoglycan receptor, which can be inhibited by the

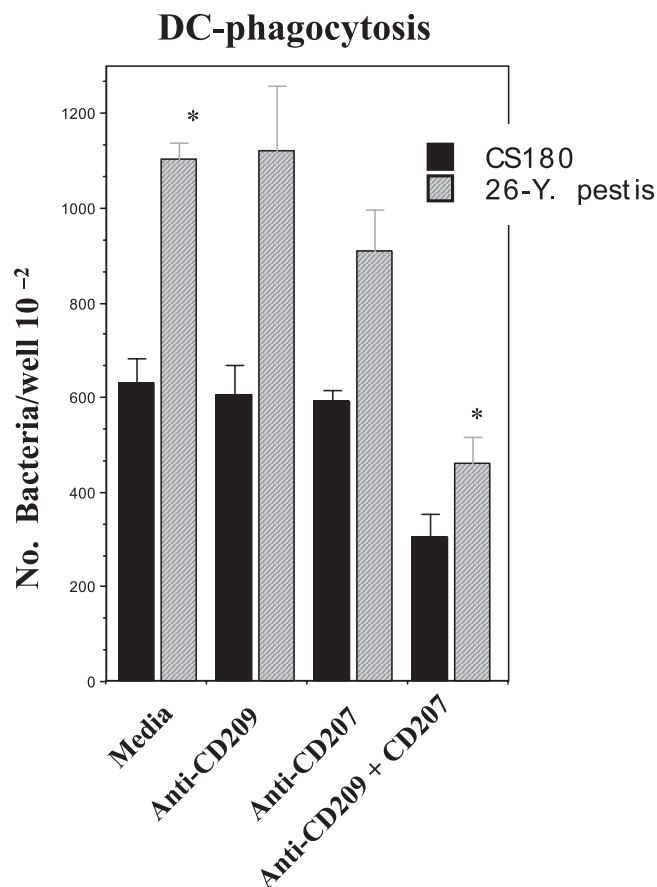

FIG. 5. Reduction of phagocytosis of *Y. pestis* by DCs in the presence of anti-DC-SIGN and -langerin (CD207) antibodies. Other than the addition of the anti-CD209 and anti-CD207 antibodies, the same procedures were followed as for DCs in Fig. 2. *, $P < 0.001$ by Student's *t* test comparing the interaction of DCs with 26-*Y. pestis* in the presence of anti-DC-SIGN and CD207 antibodies to the interaction without the presence of antibody. *n* was nine samples for each test. The error bars indicate standard errors.

addition of heparin, a synthetic form of heparan sulfate (Fig. 4A). We present this information because heparin was added in the remaining assays measuring bacterium-HeLa-DC-SIGN cell interaction in order to eliminate or reduce some non-DC-SIGN-specific interaction between *Y. pestis* and epithelial cells.

To verify that the interaction of *Y. pestis* with DC-SIGN was specific, we examined whether core LPS-DC-SIGN could be inhibited by anti-DC-SIGN antibody; mannan, which specifically binds mannose-related receptors; and a recombinant form of Mermaid (His-Mermaid), a newly identified DC-SIGN-like protein. The carbohydrate recognition domain of Mermaid shares both structural and functional similarity with that of DC-SIGN (9); therefore, a recombinant form of Mermaid was able to inhibit the core LPS-DC-SIGN interaction (62). Anti-CD66 antibody was employed as a control antibody. In addition, *E. coli* K-12 CS180 and *Y. pseudotuberculosis* serotype O:1a grown at 26°C, mediating a DC-SIGN-dependent and -independent interaction, respectively, were utilized as control strains. Anti-DC-SIGN antibody and His-Mermaid inhibited invasion of 26-*Y. pestis* in HeLa-DC-SIGN cells (Fig.

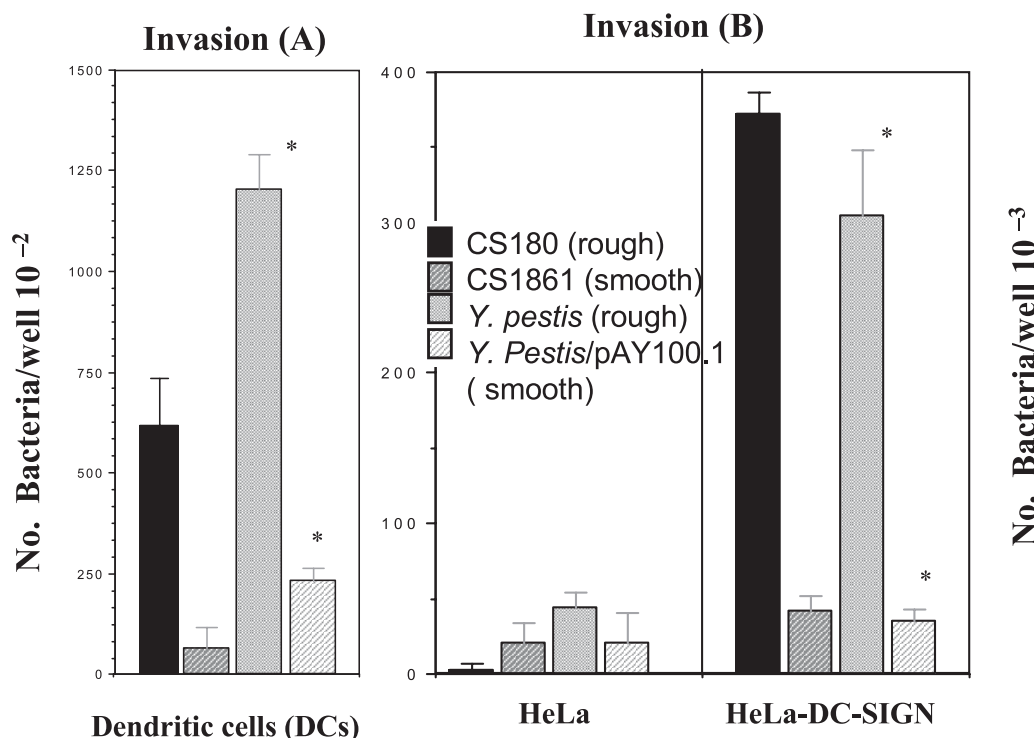

FIG. 6. O antigen-expressing *Y. pestis* loses the ability to invade DCs and HeLa-DC-SIGN cells. *Y. pestis* KIM (rough)/*Y. pestis* KIM-6/pAY100.1 (smooth) were tested for the ability to invade DCs (A) and HeLa-DC-SIGN cells (B). *E. coli* K-12 CS1861 (smooth)/CS180 (rough) were used as controls. The same methods described in the legends to Fig. 2 and 3 were applied in these experiments. *, $P < 0.001$ by Student's *t* test comparing the interaction of DCs (A) and HeLa-DC-SIGN cells (B) with *Y. pestis* KIM-6 (rough) to interaction with *Y. pestis* KIM-6/pAY100.1 (smooth). *n* was nine samples for each test. The error bars indicate standard errors.

4B). Further, mannan demonstrated the strongest inhibition ability. It should be noted that the concentrations of anti-DC-SIGN antibody, mannan, Mermaid, and heparin used in this study did not influence the viability of either bacteria or HeLa cells (62). Together, the data indicate that there is a specific interaction between DC-SIGN and LPS/LOS of *Y. pestis*.

Reduction of DC phagocytosis of *Y. pestis* by combination of anti-DC-SIGN and -langerin (CD207) antibodies. As indicated in our recent publications, the anti-DC-SIGN antibody was not effective in inhibition of the LPS core-mediated phagocytosis of *E. coli* and *N. gonorrhoeae* by DCs (32, 61, 62). We have speculated that, besides DC-SIGN, other receptors might also be involved in the phagocytosis of the core-exposed gram-negative bacteria. Fortunately, our recent unpublished observations indicate that langerin (CD207) from APCs is also a receptor for *Y. pestis*. Therefore, the experiments shown in Fig. 2 were performed in the presence of these two antibodies. As shown in Fig. 5, both antibodies, if used separately, failed to show any significant impact on the phagocytosis of *Y. pestis*. However, when the two antibodies were added together, the phagocytosis of *Y. pestis* by DCs was indeed reduced. Nevertheless, this reduction was not as strong as the inhibition of the interaction of 26-*Y. pestis* with HeLa-DC-SIGN cells (Fig. 4), suggesting that additional receptors for *Y. pestis* are present on DCs. We are currently investigating this observation further.

O antigen-expressing *Y. pestis* loses the ability to interact with DCs and DC-SIGN. Our previous publications (32, 61, 62)

and the inhibition assays (Fig. 4) clearly suggested that interaction of *Y. pestis* with DCs and DC-SIGN is due to the exposure of core LPS/LOS. However, it is possible that other surface components might bind to DC-SIGN when O antigen is deleted during evolution. *Y. pestis* might utilize other surface components, rather than core LPS, to interact with DCs and DC-SIGN. We used the KIM-6/pAY100.1 strain (smooth), which expresses O antigen from *Y. enterocolitica* serotype O:3 (43), to address this concern. We hypothesized that the ability of 26-*Y. pestis* to interact with DCs and DC-SIGN would be inhibited when the exposed core LPS is shielded by the expression of O antigen. Figure 6 shows that DCs (Fig. 6A) and HeLa-DC-SIGN cells (Fig. 6B) lost the ability to promote effective phagocytosis of *Y. pestis* expressing O antigen (KIM-6/pAY100.1). As indicated above, the interaction assay with HeLa-DC-SIGN cells was performed in the presence of heparin.

***Y. pestis*, but not its O antigen-expressing derivative, invades human alveolar macrophages.** The approaches described above were designed to address the initial stages of bubonic rather than pneumonic plague. With regard to biodefense concerns, pneumonic plague is considerably more worrisome, as the disease could initiate widespread pathogen dissemination. Therefore, we sought to determine which host immune cells are the initial targeting cells for pneumonic plague. DC-SIGN is synthesized on certain types of macrophages (23), especially human alveolar macrophages (54). We subsequently studied the role human alveolar macrophages play in *Y. pestis* infection

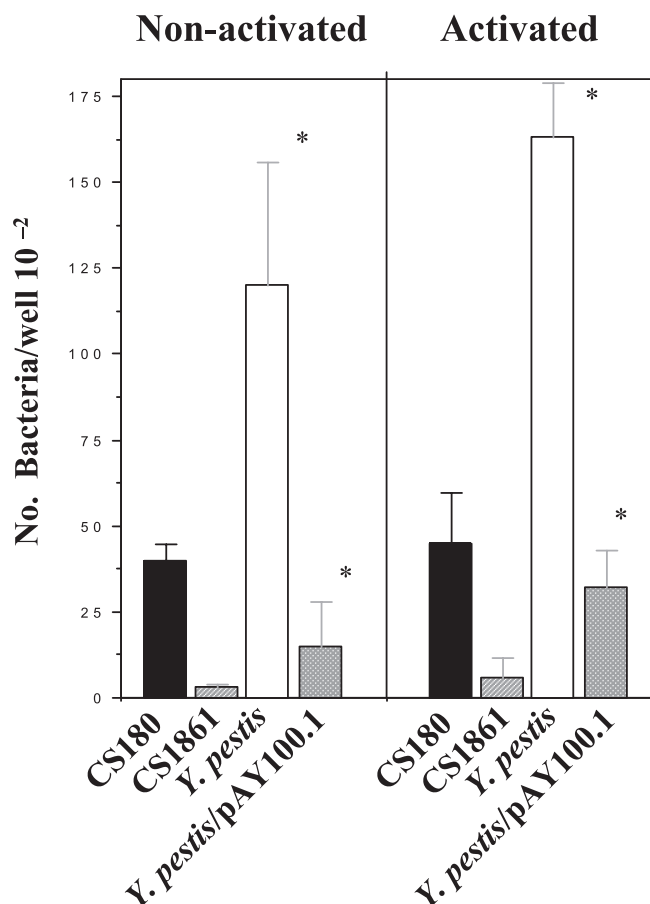

FIG. 7. Interaction of human alveolar macrophages with *Y. pestis*. Purified human alveolar macrophages were plated on 96-well plates. Half of the plated cells were activated by the addition of activators (B). The invasion assay followed the same procedures as for DCs in Fig. 2. The two pairs of strains used were *Y. pestis* KIM-6/*Y. pestis* KIM-6/pAY100.1 and *E. coli* K-12 CS180/*E. coli* K12 CS1861. *, $P < 0.001$ by Student's *t* test comparing the interaction of alveolar macrophages with *Y. pestis* KIM-6 (rough) to interaction with *Y. pestis* KIM-6/pAY100.1 (smooth). *n* was nine samples for each test. The error bars indicate standard errors.

using the methods described for human DCs. Again, two sets of strains were used for this study: *Y. pestis* KIM-6 (rough)/KIM-6/pAY100.1 (smooth) and *E. coli* K-12 CS180 (rough)/CS1861 (smooth). We also explored whether there were any differences between the phagocytosis of these bacteria and activated/nonactivated macrophages. Figure 7 shows that *Y. pestis* KIM-6 (rough) and *E. coli* K-12 CS180 (rough), rather than their smooth counterparts, invade human alveolar macrophages. It also appears that activated alveolar macrophages phagocytose more bacteria (Fig. 7B) than nonactivated macrophages, but without any statistical significance. All strains used were grown at 26°C, and the experiments were performed in the absence of heparin. This result suggests that phagocytosis of these bacteria by human alveolar macrophages is also via core LPS-DC-SIGN interaction. In short, *Y. pestis*, but not its O antigen-expressing derivative, is able to invade and survive effectively in human alveolar macrophages.

DISCUSSION

Recently, we observed that the LOS/LPS core saccharides of several gram-negative pathogens act as ligands for DC-SIGN, facilitating phagocytosis by DCs (32, 61, 62). However, it is well known that the O antigen plays a major role in the pathogenicity of gram-negative bacterial pathogens, such as *E. coli*, *Shigella*, *Klebsiella*, and *Salmonella*, promoting resistance to serum killing and phagocytosis (5, 10, 17, 42).

An important corollary to this hypothesis is that some pathogens, and probably *Y. pestis*, have evolved mechanisms for exploiting the very host defenses designed to eliminate them, resulting in an expanded ability to disseminate. Given that *Y. pestis* cannot produce an O antigen, we suggest that the exposure of the *Y. pestis* core LOS/LPS to DCs plays a fundamental role in the pathogenic process. Our results support the hypothesis that DCs use the DC-SIGN receptor to capture *Y. pestis* and may deliver the bacterium to lymph nodes to establish infection.

The idea that DCs use DC-SIGN to capture microbial pathogens for delivery to lymphocytes has been emerging since the discovery of DC-SIGN as a receptor for the gp120 antigen of HIV-1. Extensive studies of the relationship of HIV-DC-SIGN have established that DCs serve as the carrier for HIV-1, with DC-SIGN as the receptor for viral particles and delivering them to target cells, such as CD4 lymphocytes (21, 39). This concept appears to apply to *Y. pestis*, as well.

Y. pestis must be resistant to killing and digestion by DCs. Other investigators have reported that *Y. pestis* survives in macrophages (7, 15, 18). The phagocytosis experiments we used in this study are based on the ability for bacterial survival inside host cells, because gentamicin kills the extracellular bacteria but does not penetrate host cells. We were amazed to observe that *Y. pestis* survives inside DCs extremely well compared to *N. gonorrhoeae* (Fig. 2) or *E. coli*. Indeed, *Y. pestis* possessed the strongest ability to survive inside DCs among the bacterial species (*E. coli*, *Salmonella*, *Haemophilus*, and *Neisseria*) we have tested to date (unpublished data).

Although *Y. pestis* does not express invasins, it promotes a DC-SIGN-independent interaction with HeLa cells (Fig. 3 and 4). However, the interaction was inhibited by the addition of heparin, a synthetic form of heparan sulfate (Fig. 4A). Our unpublished data indicate that Ail-mediated interaction with epithelial cells involves the heparan sulfate proteoglycan. Therefore, to reduce the background (DC-SIGN-independent interaction), we added heparin in some *Y. pestis* interaction experiments.

In summary, we believe that this study has suggested four significant points. (i) The study indicates a concept for *Y. pestis* infection; after overcoming the initial, nonspecific immune defense system (e.g., the skin), *Y. pestis* may induce DCs, through the core LPS-DC-SIGN interaction, to be captured and carried to lymph nodes, utilizing a mechanism similar to that demonstrated in HIV-DC-SIGN interaction. (ii) Expression of O antigen usually enhances bacterial biological effects. However, our studies indicate that the loss of O antigen during evolution may be an important trait necessary for *Y. pestis* to disseminate from the flea bite site and establish infection at the lymph node. *Y. pestis* strains have evolved mechanisms for exploiting the very host defenses designed to eliminate them,

in order to disseminate to other parts of the host. (iii) The study will help us better understand how the life cycle of *Y. pestis* impacts infection. Given its unique life cycle, *Y. pestis* must survive and grow in a broad range of temperatures from 4°C to 41°C (7). During hibernation of rodents in winter, the temperature of the fleas associated with these animals is about 5°C (30). In the other seasons, fleas reside in rodent burrows or mammalian hair with temperatures fluctuating between 21°C and 28°C. After establishment of infection, *Y. pestis* survives and grows within bodies and body fluids of mammals (37°C to 41°C) (3). As shown in our data, *Y. pestis* grown at 6°C and 26°C, rather than 37°C, interacts with DCs and DC-SIGN. This may explain how *Y. pestis* from fleas is infectious to humans. Once delivered to lymph nodes, *Y. pestis* needs to overcome host immune systems by expressing factors, such as capsule, at 37°C to attack host cells. (iv) We emphasize that all the strains used in this work did not carry the virulence plasmid and were therefore not able to inhibit endocytosis by host cells, as the normal wild-type strain does. Therefore, we suggest that binding to DCs while blocking endocytosis via an active type III secretion system may readily allow the transport of viable bacteria to lymph nodes. (v) Human DC-SIGN is a cellular receptor for *Y. pestis*.

ACKNOWLEDGMENTS

We thank Nawal Lutfiyya at College of Medicine—Rockford, University of Illinois, for her help with statistical analysis. We thank Ines Chen and Emil C. Gotschlich for useful suggestions and editorial comments on the manuscript. We are indebted to Emil C. Gotschlich for his continual collegiality with regard to the supply of *Neisseria* strains.

This work was supported by PHS grants and an internal grant from the College of Medicine—Rockford, University of Illinois, to T. Chen. The work in the Skurnik laboratory is supported by funding from the Academy of Finland (grant 114075).

REFERENCES

- Achtman, M., G. Morelli, P. Zhu, T. Wirth, I. Diehl, B. Kusecek, A. J. Vogler, D. M. Wagner, C. J. Allender, W. R. Easterday, V. Chenal-Francoise, P. Worsham, N. R. Thomson, J. Parkhill, L. E. Lindler, E. Carniel, and P. Keim. 2004. Microevolution and history of the plague bacillus, *Yersinia pestis*. *Proc. Natl. Acad. Sci. USA* **101**:17837–17842.
- Achtman, M., K. Zurth, G. Morelli, G. Torrea, A. Guiyoule, and E. Carniel. 1999. *Yersinia pestis*, the cause of plague, is a recently emerged clone of *Yersinia pseudotuberculosis*. *Proc. Natl. Acad. Sci. USA* **96**:14043–14048.
- Anisimov, A. P., L. E. Lindler, and G. B. Pier. 2004. Intraspecific diversity of *Yersinia pestis*. *Clin. Microbiol. Rev.* **17**:434–464.
- Bartra, S. S., K. L. Styer, D. M. O'Bryant, M. L. Nilles, B. J. Hinnebusch, A. Aballay, and G. V. Plano. 2007. Resistance of *Yersinia pestis* to complement-dependent killing is mediated by the Ail outer membrane protein. *Infect. Immun.* **76**:612–622.
- Bengochea, J. A., H. Najdenski, and M. Skurnik. 2004. Lipopolysaccharide O antigen status of *Yersinia enterocolitica* O:8 is essential for virulence and absence of O antigen affects the expression of other *Yersinia* virulence factors. *Mol. Microbiol.* **52**:451–469.
- Bliska, J. B., M. C. Copass, and S. Falkow. 1993. The *Yersinia pseudotuberculosis* adhesin YadA mediates intimate bacterial attachment to and entry into HEp-2 cells. *Infect. Immun.* **61**:3914–3921.
- Brubaker, R. R. 1991. Factors promoting acute and chronic diseases caused by yersiniae. *Clin. Microbiol. Rev.* **4**:309–324.
- Brubaker, R. R. 1983. The *Vva*⁺ virulence factor of yersiniae: the molecular basis of the attendant nutritional requirement for Ca⁺⁺. *Rev. Infect. Dis.* **5**(Suppl. 4):S748–S758.
- Bulgheresi, S., I. Schabussova, T. Chen, N. P. Mullin, R. M. Maizels, and J. A. Ott. 2006. A new C-type lectin similar to the human immunoreceptor DC-SIGN mediates symbiont acquisition by a marine nematode. *Appl. Environ. Microbiol.* **72**:2950–2956.
- Burns, S. M., and S. I. Hull. 1998. Comparison of loss of serum resistance by defined lipopolysaccharide mutants and an acapsular mutant of uropathogenic *Escherichia coli* O75:K5. *Infect. Immun.* **66**:4244–4253.
- Chen, T., R. Belland, J. Wilson, and J. Swanson. 1995. Adherence of pilus⁺ Opa⁺ gonococci to epithelial cells in vitro involves heparan sulfate. *J. Exp. Med.* **182**:511–517.
- Chen, T., S. Bolland, I. Chen, J. Parker, M. Pantelic, F. Grunert, and W. Zimmermann. 2001. The CGM1a (CEACAM3/CD66d) mediated phagocytic pathway of *Neisseria gonorrhoeae* expressing Opacity (Opa) proteins is also the pathway to cell death. *J. Biol. Chem.* **276**:17413–17419.
- Chen, T., and E. Gotschlich. 1996. CGM1a antigen of neutrophils, a receptor of gonococcal opacity proteins. *Proc. Natl. Acad. Sci. USA* **93**:14851–14856.
- Chen, T., F. Grunert, A. Medina-Marino, and E. Gotschlich. 1997. Several carcinoembryonic antigens (CD66) serve as receptors for gonococcal opacity proteins. *J. Exp. Med.* **185**:1557–1564.
- Cornelis, G. R. 2002. *Yersinia* type III secretion: send in the effectors. *J. Cell Biol.* **158**:401–408.
- Cornelis, G. R., and H. Wolf-Watz. 1997. The *Yersinia* Yop virulon: a bacterial system for subverting eukaryotic cells. *Mol. Microbiol.* **23**:861–867.
- Cortes, G., N. Borrell, B. de Astorza, C. Gomez, J. Saulea, and S. Alberti. 2002. Molecular analysis of the contribution of the capsular polysaccharide and the lipopolysaccharide O side chain to the virulence of *Klebsiella pneumoniae* in a murine model of pneumonia. *Infect. Immun.* **70**:2583–2590.
- Du, Y., R. Rosqvist, and A. Forsberg. 2002. Role of fraction 1 antigen of *Yersinia pestis* in inhibition of phagocytosis. *Infect. Immun.* **70**:1453–1460.
- Engering, A., S. J. Van Vliet, T. B. Geijtenbeek, and Y. Van Kooyk. 2002. Subset of DC-SIGN⁺ dendritic cells in human blood transmits HIV-1 to T lymphocytes. *Blood* **100**:1780–1786.
- Fetherston, J. D., P. Schuetze, and R. D. Perry. 1992. Loss of the pigmentation phenotype in *Yersinia pestis* is due to the spontaneous deletion of 102 kb of chromosomal DNA which is flanked by a repetitive element. *Mol. Microbiol.* **6**:2693–2704.
- Geijtenbeek, T. B., D. S. Kwon, R. Torensma, S. J. van Vliet, G. C. van Duinhoven, J. Middel, I. L. Cornelissen, H. S. Nottet, V. N. KewalRamani, D. R. Littman, C. G. Figdor, and Y. van Kooyk. 2000. DC-SIGN, a dendritic cell-specific HIV-1-binding protein that enhances trans-infection of T cells. *Cell* **100**:587–597.
- Gotschlich, E. 1994. Genetic locus for the biosynthesis of the variable portion of *Neisseria gonorrhoeae* lipooligosaccharide. *J. Exp. Med.* **180**:2181–2190.
- Granelli-Piperno, A., A. Pritsker, M. Pack, I. Shimeliovich, J. F. Arrighi, C. G. Park, C. Trumppheller, V. Piguet, T. M. Moran, and R. M. Steinman. 2005. Dendritic cell-specific intercellular adhesion molecule 3-grabbing non-integrin/CD209 is abundant on macrophages in the normal human lymph node and is not required for dendritic cell stimulation of the mixed leukocyte reaction. *J. Immunol.* **175**:4265–4273.
- Hinnebusch, B. J., A. E. Rudolph, P. Cherepanov, J. E. Dixon, T. G. Schwan, and A. Forsberg. 2002. Role of *Yersinia* murine toxin in survival of *Yersinia pestis* in the midgut of the flea vector. *Science* **296**:733–735.
- Isberg, R., L. Deborah, S. Voorhis, and S. Falkow. 1987. Identification of invasins: a protein that allows enteric bacteria to penetrate cultured mammalian cells. *Cell* **50**:769–778.
- Isberg, R., and S. Falkow. 1985. A single genetic locus encoded by *Yersinia pseudotuberculosis* permits invasion of cultured animal cells by *Escherichia coli* K-12. *Nature* **317**:262–264.
- Isberg, R. R., and P. Barnes. 2001. Subversion of integrins by enteropathogenic *Yersinia*. *J. Cell Sci.* **114**:21–28.
- Jarrett, C. O., E. Deak, K. E. Isherwood, P. C. Oyston, E. R. Fischer, A. R. Whitney, S. D. Kobayashi, F. R. DeLeo, and B. J. Hinnebusch. 2004. Transmission of *Yersinia pestis* from an infectious biofilm in the flea vector. *J. Infect. Dis.* **190**:783–792.
- Karlyshev, A. V., E. E. Galyov, O. Smirnov, A. P. Guzeyev, V. M. Abramov, and V. P. Zavyalov. 1992. A new gene of the f1 operon of *Y. pestis* involved in the capsule biogenesis. *FEBS Lett.* **297**:77–80.
- Kauffman, A. S., M. J. Paul, and I. Zucker. 2004. Increased heat loss affects hibernation in golden-mantled ground squirrels. *Am. J. Physiol. Regul. Integr. Comp. Physiol.* **287**:R167–R173.
- Klena, J., R. S. Ashford II, and C. A. Schnaitman. 1992. Role of *Escherichia coli* K-12 *rfa* genes and the *rff* gene of *Shigella dysenteriae* 1 in generation of lipopolysaccharide core heterogeneity and attachment of O antigen. *J. Bacteriol.* **174**:7297–7307.
- Klena, J., P. Zhang, O. Schwartz, S. Hull, and T. Chen. 2005. The core lipopolysaccharide of *Escherichia coli* is a ligand for DC-SIGN (CD209) receptor. *J. Bacteriol.* **187**:1710–1715.
- Klena, J. D., and C. A. Schnaitman. 1993. Function of the *rff* gene cluster and the *rfe* gene in the synthesis of O antigen by *Shigella dysenteriae* 1. *Mol. Microbiol.* **9**:393–402.
- Kolodziejek, A. M., D. J. Sinclair, K. S. Seo, D. R. Schneider, C. F. Deobald, H. N. Rohde, A. K. Viall, S. S. Minnich, C. J. Hovde, S. A. Minnich, and G. A. Bohach. 2007. Phenotypic characterization of OmpX, an Ail homologue of *Yersinia pestis* KIM. *Microbiology* **153**:2941–2951.
- Kutyrev, V., R. J. Mehig, V. L. Motin, M. S. Pokrovskaya, G. B. Smirnov, and R. R. Brubaker. 1999. Expression of the plague plasminogen activator in *Yersinia pseudotuberculosis* and *Escherichia coli*. *Infect. Immun.* **67**:1359–1367.

36. Lathem, W. W., P. A. Price, V. L. Miller, and W. E. Goldman. 2007. A plasminogen-activating protease specifically controls the development of primary pneumonic plague. *Science* **315**:509–513.
37. Li, G., Y. J. Kim, C. Mantel, and H. E. Broxmeyer. 2003. P-selectin enhances generation of CD14⁺CD16⁺ dendritic-like cells and inhibits macrophage maturation from human peripheral blood monocytes. *J. Immunol.* **171**:669–677.
38. Marketon, M. M., R. W. DePaolo, K. L. DeBord, B. Jabri, and O. Schneewind. 2005. Plague bacteria target immune cells during infection. *Science* **309**:1739–1741.
39. McDonald, D., L. Wu, S. M. Bohks, V. N. KewalRamani, D. Unutmaz, and T. J. Hope. 2003. Recruitment of HIV and its receptors to dendritic cell-T cell junctions. *Science* **300**:1295–1297.
40. Miller, V. L., and S. Falkow. 1988. Evidence for two genetic loci in *Yersinia enterocolitica* that can promote invasion of epithelial cells. *Infect. Immun.* **56**:1242–1248.
41. Morona, R., C. Daniels, and L. Van Den Bosch. 2003. Genetic modulation of *Shigella flexneri* 2a lipopolysaccharide O antigen modal chain length reveals that it has been optimized for virulence. *Microbiology* **149**:925–939.
42. Murray, G. L., S. R. Attridge, and R. Morona. 2003. Regulation of *Salmonella typhimurium* lipopolysaccharide O antigen chain length is required for virulence; identification of FepE as a second Wzz. *Mol. Microbiol.* **47**:1395–1406.
43. Oyston, P. C., J. L. Prior, S. Kiljunen, M. Skurnik, J. Hill, and R. W. Titball. 2003. Expression of heterologous O-antigen in *Yersinia pestis* KIM does not affect virulence by the intravenous route. *J. Med. Microbiol.* **52**:289–294.
44. Portnoy, D. A., and R. J. Martinez. 1985. Role of a plasmid in the pathogenicity of *Yersinia* species. *Curr. Top. Microbiol. Immunol.* **118**:29–51.
45. Prior, J. L., J. Parkhill, P. G. Hitchen, K. L. Mungall, K. Stevens, H. R. Morris, A. J. Reason, P. C. Oyston, A. Dell, B. W. Wren, and R. W. Titball. 2001. The failure of different strains of *Yersinia pestis* to produce lipopolysaccharide O-antigen under different growth conditions is due to mutations in the O-antigen gene cluster. *FEMS Microbiol. Lett.* **197**:229–233.
46. Riley, G., and S. Toma. 1989. Detection of pathogenic *Yersinia enterocolitica* by using Congo red-magnesium oxalate agar medium. *J. Clin. Microbiol.* **27**:213–214.
47. Rosqvist, R., M. Skurnik, and H. Wolf-Watz. 1988. Increased virulence of *Yersinia pseudotuberculosis* by two independent mutations. *Nature* **334**:522–524.
48. Russo, T. A., B. A. Davidson, U. B. Carlino-MacDonald, J. D. Helinski, R. L. Priore, and P. R. Knight III. 2003. The effects of *Escherichia coli* capsule, O-antigen, host neutrophils, and complement in a rat model of Gram-negative pneumonia. *FEMS Microbiol. Lett.* **226**:355–361.
49. Schnaitman, C. A., and J. D. Klena. 1993. Genetics of lipopolysaccharide biosynthesis in enteric bacteria. *Microbiol. Rev.* **57**:655–682.
50. Sebbane, F., C. O. Jarrett, D. Gardner, D. Long, and B. J. Hinnebusch. 2006. Role of the *Yersinia pestis* plasminogen activator in the incidence of distinct septicemic and bubonic forms of flea-borne plague. *Proc. Natl. Acad. Sci. USA* **103**:5526–5530.
51. Skurnik, M., and H. Wolf-Watz. 1989. Analysis of the *yopA* gene encoding the Yop1 virulence determinants of *Yersinia* spp. *Mol. Microbiol.* **3**:517–529.
52. SolFoulon, N., A. Moris, C. Nobile, C. Boccaccio, A. Engering, J. P. Abastado, J. M. Heard, Y. van Kooyk, and O. Schwartz. 2002. HIV-1 Nef-induced upregulation of DC-SIGN in dendritic cells promotes lymphocyte clustering and viral spread. *Immunity* **16**:145–155.
53. Steeghs, L., U. Uronen-Hansson, S. Van Vliet, A. Van Mourik, N. Klein, Y. Van Kooyk, R. Callard, J. Van de Winkel, and P. Van der Ley. 2006. Lipopolysaccharide-mediated targeting of *Neisseria meningitidis* to dendritic cells: binding of *IgtB* LPS to DC-SIGN. *Cell. Microbiol.* **8**:316–325.
54. Tailleux, L., N. Pham-Thi, A. Bergeron-Lafaurie, J. L. Herrmann, P. Charles, O. Schwartz, P. Scheinmann, P. H. Lagrange, J. de Blic, A. Tazi, B. Gicquel, and O. Neyrolles. 2005. DC-SIGN induction in alveolar macrophages defines privileged target host cells for mycobacteria in patients with tuberculosis. *PLoS Med.* **2**:e381.
55. Tailleux, L., O. Schwartz, J. L. Herrmann, E. Pivert, M. Jackson, A. Amara, L. Legres, D. Dreher, L. P. Nicod, J. C. Gluckman, P. H. Lagrange, B. Gicquel, and O. Neyrolles. 2003. DC-SIGN is the major *Mycobacterium tuberculosis* receptor on human dendritic cells. *J. Exp. Med.* **197**:121–127.
56. van Kooyk, Y., and T. B. Geijtenbeek. 2003. DC-SIGN: escape mechanism for pathogens. *Nat. Rev. Immunol.* **3**:697–709.
57. Vazquez-Torres, A., and F. C. Fang. 2000. Cellular routes of invasion by enteropathogens. *Curr. Opin. Microbiol.* **3**:54–59.
58. Viboud, G. I., and J. B. Bliska. 2005. *Yersinia* outer proteins: role in modulation of host cell signaling responses and pathogenesis. *Annu. Rev. Microbiol.* **59**:69–89.
59. Weeks, S., J. Hill, A. Friedlander, and S. Welkos. 2002. Anti-V antigen antibody protects macrophages from *Yersinia pestis*-induced cell death and promotes phagocytosis. *Microb. Pathog.* **32**:227–237.
60. Zhang, J., G. Li, A. Bafica, M. Pantelic, P. Zhang, H. Broxmeyer, L. M. Wetzler, J. He, and T. Chen. 2005. *Neisseria gonorrhoeae* enhances the infection of dendritic cells by human immunodeficiency virus type-1 (HIV-1). *J. Immunol.* **174**:7995–8002.
61. Zhang, P., O. Schwartz, M. Pantelic, G. Li, Q. Knazze, C. Nobile, M. Radovich, J. He, S. C. Hong, J. Klena, and T. Chen. 2006. DC-SIGN (CD209) recognition of *Neisseria gonorrhoeae* is circumvented by lipooligosaccharide variation. *J. Leukoc. Biol.* **79**:731–738.
62. Zhang, P., S. Snyder, P. Feng, P. Azadi, S. Zhang, S. Bulgheresi, K. E. Sanderson, J. He, J. Klena, and T. Chen. 2006. Role of *N*-acetylglucosamine within core lipopolysaccharide of several species of Gram-negative bacteria in targeting the DC-SIGN (CD209). *J. Immunol.* **177**:4002–4011.
63. Zhou, L. J., and T. F. Tedder. 1996. CD14⁺ blood monocytes can differentiate into functionally mature CD83⁺ dendritic cells. *Proc. Natl. Acad. Sci. USA* **93**:2588–2592.
64. Zhou, L. J., and T. F. Tedder. 1995. Human blood dendritic cells selectively express CD83, a member of the immunoglobulin superfamily. *J. Immunol.* **154**:3821–3835.