

# Identification of the Dicyclohexylcarbodiimide-Reactive Protein Component of the Adenosine 5'-Triphosphate Energy-Transducing System of *Escherichia coli*

ROBERT H. FILLINGAME<sup>1</sup>

Department of Biological Chemistry, Harvard Medical School, Boston, Massachusetts 02115

Received for publication 30 June 1975

Membranes of *Escherichia coli* contain an adenosine 5'-triphosphate (ATP) energy-transducing system that is inhibited by treatment with dicyclohexylcarbodiimide (DCCD). The carbodiimide-reactive protein component of this system has been identified after treatment with [<sup>14</sup>C]DCCD. This protein has an apparent molecular weight of 9,000 as judged from acrylamide gel electrophoresis in the presence of sodium dodecyl sulfate and is extracted from the membrane with chloroform-methanol (2:1). These properties are similar to the analogous protein previously identified in mitochondria (Cattell et al., 1971). A mutant strain, RF-7, has been isolated which derives energy from oxidative phosphorylation in the presence of 5 mM DCCD. The ATP hydrolase activity of the membrane system in the mutant was considerably less sensitive to inhibition by DCCD than that in the wild type. The carbodiimide-reactive protein, which was easily labeled by [<sup>14</sup>C]DCCD in the wild type, was labeled much less rapidly in the carbodiimide-resistant mutant. It is thus concluded that the reaction of DCCD with this specific protein leads to inhibition of the ATP energy-transducing reactions. The mutation causing carbodiimide resistance in strain RF-7 was mapped. It is co-transduced with the *uncA* gene at a frequency exceeding 90%. The mutationally altered protein causing the carbodiimide resistance was not conclusively identified. However, reconstitution experiments indicate that the altered protein is not one of the subunits of the soluble ATP hydrolase activity, which can be removed from the membrane by washing with 1 mM tris(hydroxymethyl)amino-methane buffer lacking Mg<sup>2+</sup>. The carbodiimide-reactive protein remains with the membrane residue after removal of the soluble ATP hydrolase and is thus distinct from these subunits as well.

The membrane-associated adenosine triphosphatase (ATPase) of *Escherichia coli* is inhibited by dicyclohexylcarbodiimide (DCCD) (15, 19, 32), as are other energy-transducing reactions of this adenosine 5'-triphosphate (ATP) energy-transducing system, e.g., oxidative phosphorylation, ATP-dependent transhydrogenation, and ATP-driven transport of sugars and amino acids by anaerobic or cyanide-poisoned cells (22, 23, 28, 29). Analogous systems in mitochondria, chloroplasts, and other bacteria are also inhibited by DCCD (5, 21, 26). The ATPase activity of these systems becomes insensitive to DCCD when it is removed from the membrane by manipulation of the ionic conditions of the medium (21, 31, 32, 38). It can be inferred that the carbodiimide-reactive component resides in the washed membrane residue since reconstitution of the solubilized ATP-

ase with the washed membrane fraction restores DCCD sensitivity (1, 9, 21, 24, 32). Abrams et al. (1) have presented genetic evidence for such a membrane-associated component in *Streptococcus faecalis*.

Other experiments suggest that the DCCD-reactive component of the ATP energy-transducing system may play a prominent role in energy transduction. (i) Respiration-driven reactions are greatly reduced in *E. coli* membranes from which the ATPase has been removed (7, 18, 28), the energized state being dissipated in its absence as shown schematically in Fig. 1. However, when such stripped membranes were treated with DCCD, the capacity to be energized by respiration was restored (8, 28, 35), presumably because the energy-dissipating reaction was blocked (Fig. 1). Analogous effects of DCCD or oligomycin have been observed with membrane particles from mitochondria and chloroplasts (6, 13, 26, 31). (ii) Several ATPase mutants of *E. coli* have been isolated in which

<sup>1</sup> Present address: Department of Physiological Chemistry, Medical Sciences Building, University of Wisconsin, Madison, Wis. 53706.

## I. NATIVE MEMBRANES

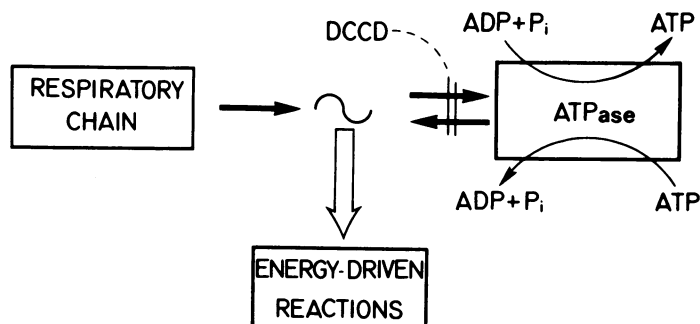

## II. ATPase DEPLETED MEMBRANES

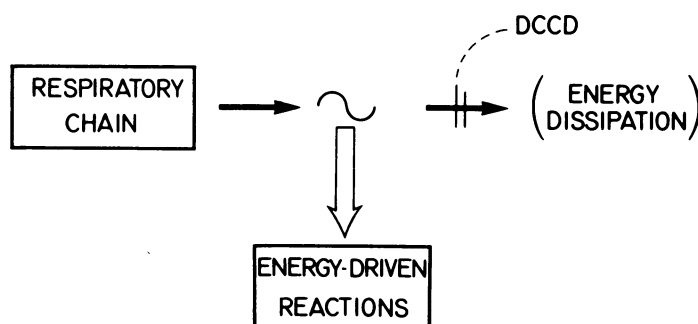

FIG. 1. Schematic representation of relationship of respiratory chain and the membrane-bound ATPase to the energized state ( $\sim$ ). The phenomenological site of inhibition of DCCD in this scheme is also indicated.

the energized state (generated via respiration) was dissipated in the presence of the structurally altered ATPase. In the mutants examined, the membrane was shown to be quite permeable to protons (2, 33, 35), which is probably the mode of energy dissipation, and the membrane potential normally established by respiration was not observed (2). Treatment with DCCD reduced the proton permeability of these mutant membranes to normal, which permitted establishment of the membrane potential (2, 33, 35). This treatment, which blocks dissipation of the energized state, restored respiration-dependent active transport (2, 33, 34, 35, 42, 43), transhydrogenation (8), and quenching of fluorescence by an acridine dye (28, 35) in the mutants. (iii) Several mutants of *E. coli*, incapable of oxidative phosphorylation or ATP-driven energy-transducing reactions, have been isolated that exhibit normal respiration and normal levels of ATPase activity (11, 19, 28, 36). In the cases examined the ATPase was not sensitive to DCCD (19, 28). These observations suggest that the DCCD sensitivity of the ATPase activity may be an index of whether the ATPase is linked to the membrane in an energy-transducing manner.

The mechanism by which DCCD inhibits the membrane-associated ATPase and the nature of the carbodiimide-reactive component in *E. coli* are unknown. Studies with the analogous energy-transducing system in mitochondria hint at the mechanism and nature of this component. DCCD reacts irreversibly and probably covalently with a specific carbodiimide-reactive protein in mitochondria (6, 9, 12, 40). Studies with [ $^{14}\text{C}$ ]DCCD have shown labeling of primarily one membrane protein as analyzed by electrophoresis on polyacrylamide gels in the presence of sodium dodecyl sulfate (12, 40). However, no direct evidence was presented that demonstrated that reaction of DCCD with this protein was related to inhibition of the ATPase. The initial purpose of the present study was to determine the site of inhibition of DCCD in *E. coli* by comparing the species of protein labeled by [ $^{14}\text{C}$ ]DCCD in wild-type and a carbodiimide-resistant mutant.

## MATERIALS AND METHODS

**Strains and medium.** The strains used are listed in Table 1. All strains were routinely grown in medium 63 (14) containing 0.2 mM L-arginine, 0.1% Casamino Acids (Difco), and 2 mg of thiamine per

TABLE 1. *E. coli* K-12 strains used

Strain	Genetic markers	Source (reference)	Phenotype
AN180	<i>argE3, thi-1</i> , Str <sup>R</sup>	G. B. Cox (10)	Wild-type ATPase
RF-7	<i>argE3, thi-1</i> , Str <sup>R</sup> , <i>dcc-1</i>	Selected from AN180 after mutagenesis (see text)	DCCD-resistant ATPase
AN120	<i>argE3, thi-1</i> , Str <sup>R</sup> <i>uncA401</i>	G. B. Cox (10)	Lacks ATPase activity
RF-t136	<i>argE3, thi-1</i> , Str <sup>R</sup>	Transductant of AN120 from P1 lysate of RF-7	Wild-type ATPase
RF-t013, RF-t129, RF-t263	<i>argE3, thi-1</i> , Str <sup>R</sup> , <i>dcc-1</i>	Transductants of AN120 from P1 lysate of RF-7	DCCD-resistant ATPase
AN382	<i>argE3, thi-1</i> , Str <sup>R</sup> , <i>uncB401</i>	Yale <i>E. coli</i> Genetic Stock Center via D. G. Fraenkel (11)	ATPase incapable of energy transduction and DCCD-in- sensitive

liter. In most of the experiments utilizing strains AN180 and RF-7 the carbon sources were 22 mM sodium succinate, 30 mM potassium acetate, and 17 mM potassium L-malate. Strain AN120 was grown on 11 mM D-glucose and AN382 on 109 mM glycerol as carbon sources.

**Selection of mutants with DCCD-resistant growth.** A functional ATPase is required for growth of *E. coli* (via oxidative phosphorylation) on succinate, acetate, or malate (10, 37). DCCD at concentrations greater than 1 mM inhibited growth on these carbon sources. Agar plates (supplemented with medium 63, succinate, acetate, malate, L-arginine, and thiamine) containing 5 mM DCCD were prepared by adding 2 ml of 0.5 M DCCD (Aldrich, Milwaukee, Wis.) in ethanol to 200 ml of autoclaved agar suspension at 50 C. On cooling, a greasy crust of DCCD had formed over the surface of the agar. Samples (10<sup>8</sup> cells in 0.1 ml) of AN180 were spread on freshly prepared plates and allowed to stand for 3 h until dry, as the aqueous cell suspension was not absorbed rapidly by the greasy plate. A crystal of *N*-methyl-*N'*-nitro-*N*-nitrosoguanidine was placed in the center of each plate, and the plates were incubated for 5 days at 37 C. A faint lawn of background growth encompassed a clear ring of killing around the crystal of mutagen, but distinct colonies were observed near the ring of killing. Twenty such colonies were purified, and their growth was shown to be DCCD resistant in liquid culture. All remained arginine auxotrophs and streptomycin resistant.

**Transduction with bacteriophage P1kc.** The method described by Miller (27) was used. Phage P1kc was titered and grown on strain RF-7. Strain AN120 was infected with this lysate at a multiplicity of infection of 1/5. Transductants capable of growth on succinate, arginine, and thiamine were selected. The ability of these transductants to grow in the presence of DCCD was checked either in liquid culture or by replica plating with toothpicks on plates containing 5 mM DCCD, 1% ethanol, succinate, acetate, malate, L-arginine, and thiamine.

**Preparation of membranes and ATPase assay.** Cells were harvested in late exponential or early stationary phase and washed with 50 mM tris(hydroxymethyl)aminomethane (Tris)-sulfate (pH 7.8)–10 mM MgSO<sub>4</sub>. A 10 to 20% (wt/vol) suspension of

cells in the same buffer containing 0.1 mM disodium ethylenediaminetetraacetic acid, 1 mM dithiothreitol and 0.1 mg of deoxyribonuclease I (Worthington, Freehold, N.J.) per ml was passed through a French press at 500 atm. Unbroken cells were removed by two sequential centrifugations at 5,000 × *g* for 15 min. Membranes were pelleted by centrifugation at 40,000 rpm (145,000 × *g*<sub>max</sub>) for 60 min in a Beckman type 40 rotor, washed once, and resuspended at 30 mg of protein/ml in 50 mM Tris-sulfate (pH 7.8)–10 mM MgSO<sub>4</sub>–1 mM dithiothreitol. ATPase activity was assayed at 30 C as described (20) with 0.2 mM MgSO<sub>4</sub> and 0.4 mM [ $\gamma$ -<sup>32</sup>P]ATP in the assay. The reaction was terminated with trichloroacetic acid, and the inorganic phosphate liberated was extracted as a molybdate complex into isobutanol-benzene (1:1). The incubation time and concentration of membrane protein was adjusted so that the assay was linear (less than 10% of the ATP hydrolyzed), despite the absence of an ATP-regenerating system. A unit of activity is defined as one micromole of inorganic phosphate liberated per minute.

**Preparation of stripped membranes, soluble ATPase and reconstitution.** The procedure used for the preparation of stripped membranes, soluble ATPase, and reconstitution was a modification of the method of Bragg and Hou (7). Membranes were incubated at 5 mg of protein/ml in 1 mM Tris-sulfate (pH 7.8)–0.2 mM dithiothreitol at 30 C for 30 min and then centrifuged at 40,000 rpm for 60 min at 4 C. The supernatant solution, containing 70% of the ATPase activity, was centrifuged again. Subsequent steps were performed at room temperature due to the cold lability of the ATPase. The ATPase was precipitated from the supernatant solution by the addition of 1.5 volumes of saturated (NH<sub>4</sub>)<sub>2</sub>SO<sub>4</sub>. The precipitate was dissolved in 50 mM Tris-sulfate (pH 7.8)–10 mM MgSO<sub>4</sub>–0.2 mM dithiothreitol–10% (vol/vol) glycerol, dialyzed overnight against 200 volumes of this buffer at room temperature, and clarified by centrifugation at 40,000 rpm for 60 min. This fraction is referred to as "soluble ATPase."

The membrane residue from the first wash was washed a second time and then dialyzed versus 1 mM Tris-sulfate (pH 7.8)–0.2 mM dithiothreitol–0.1 mM ethylenediaminetetraacetic acid overnight at 4 C. After centrifugation the membrane residue

("stripped membrane") was suspended in 50 mM Tris-sulfate (pH 7.8)–10 mM MgSO<sub>4</sub>–0.2 mM dithiothreitol.

Reconstituted membranes were prepared by mixing 4 U of soluble ATPase and 2 mg of stripped membrane per ml of 50 mM Tris-sulfate containing 10 mM MgSO<sub>4</sub> and 0.2 mM dithiothreitol. After 45 min at 30 C the reconstituted membranes were centrifuged at 40,000 rpm for 60 min.

**Preparation of [<sup>14</sup>C]DCCD.** Radioactive DCCD of high specific activity was prepared on a micro-scale from [<sup>14</sup>C]urea by a modification of the procedure of Stekhoven et al. (40). [<sup>14</sup>C]urea (60 mCi/mmol; New England Nuclear, Boston, Mass.), 0.874 mCi, and 1.00 mg of nonradioactive urea (Mann Ultrapure, New York, N.Y.) were incubated in 0.2 ml of redistilled cyclohexylamine (Eastman, Rochester, N.Y.) at 150 C for 4.5 h after deaeration and flushing with nitrogen. The product (dicyclohexylurea) was washed with 1 N HCl (twice), water, 90% ethanol, and diethyl ether, and crystallized from absolute ethanol (64% yield). To the dicyclohexyl-<sup>14</sup>C]urea in 0.3 ml of redistilled pyridine was added an eightfold molar excess of freshly redistilled POCl<sub>3</sub> (Fisher, Fair Lawn, N.J.), and the mixture was heated for 2 h at 85 to 90 C. After cooling, 2 ml of water and 3.5 ml of petroleum ether were added and rapidly mixed, and the tube was centrifuged in a clinical centrifuge. The petroleum ether layer was extracted once with 1.5 ml of water and then taken to dryness with a stream of nitrogen. The dry residue was dissolved in 3 ml of benzene, and 0.25 g of aluminum oxide G was added (Merck 1090 for thin-layer chromatography; Darmstadt, Germany). The tube was vigorously mixed five times over a 10-min period and then centrifuged. The supernatant benzene extract was passed through a glass wool plug in a Pasteur pipette and taken to dryness by freeze drying, and the residue was dissolved in absolute ethanol. Aluminum oxide adsorption removed radioactive impurities and unidentified material which caused rapid breakdown of the DCCD. The overall yield of [<sup>14</sup>C]DCCD (28.1 mCi/mmol) was 48%. The product was >94% radiochemically pure as judged by thin-layer chromatography (aluminum oxide G developed with benzene) and showed concentration versus inhibition curves identical to unlabeled, authentic DCCD for inhibition of the ATPase. The [<sup>14</sup>C]DCCD showed no deterioration on storage in absolute ethanol at –20 C during the initial year of storage.

**Labeling of membranes with [<sup>14</sup>C]DCCD.** Conditions were sought which minimized nonspecific labeling but which resulted in maximal inhibition of the ATPase. Routinely, a 20 mg of protein/ml suspension of membranes in 0.25 M sucrose–10 mM Tris-sulfate (pH 7.6)–5 mM MgSO<sub>4</sub>–0.2 mM dithiothreitol was made 100 μM in [<sup>14</sup>C]DCCD (by the addition of 0.01 volumes of 10 mM [<sup>14</sup>C]DCCD in absolute ethanol) and stirred for 24 h at 0 C. The suspension was then diluted 1/20 in suspension buffer, centrifuged, and washed three times. The prolonged labeling time at 0 C resulted in less nonspecific labeling than shorter labeling periods at 30 C.

**Acrylamide gel electrophoresis.** The procedure of Laemmli (25) was used, but with gels containing 13% acrylamide and 0.41% methylenebisacrylamide. Samples were dissolved by heating at 45 C for 16 h in 0.05 M Tris-chloride (pH 6.8)–2% sodium dodecyl sulfate–10% (vol/vol) glycerol–1% 2-mercaptoethanol. Radioactive gels were sliced into 2-mm slices with a manual screw-type apparatus. Slices were dissolved in 1.5 ml of 6% H<sub>2</sub>O<sub>2</sub> by incubation at 55 C for 24 h in tightly capped vials and counted in 15 ml of scintillation fluid (30). Gels were stained for 6 to 12 h by the procedure of Weber and Osborn (44) after fixation in 50% trichloroacetic acid (12 h) followed by 9% acetic acid in 45% methanol (12 h). Late in this study, it was determined that phospholipid in the proteolipid preparations ran as a broad band which overlapped some proteolipid protein bands. Increasing the concentration of sodium dodecyl sulfate in the gels from 0.1 to 0.2% caused the phospholipid to run as a discrete band nearer the bromophenol blue dye front and led to better resolution of low-molecular-weight proteins.

**Preparation of proteolipid.** Proteins soluble in chloroform-methanol (2:1), which are commonly referred to as "proteolipids" (16), were extracted by the method of Cattell et al. (12). A membrane suspension, in distilled water at 30 to 60 mg of protein/ml, was added to 25 volumes of chloroform-methanol (2:1) and stirred at 4 C for 24 h. The chloroform-methanol supernatant was washed by the procedure of Folch et al. (17). The lower phase was diluted (slowly with stirring) with 1 volume of chloroform and the requisite amount of methanol required to keep the solution clear. It could then be taken to dryness on a roto-evaporator (35 C) as a single phase without frothing. The residue was taken up in chloroform-methanol (2:1), and 4 volumes of diethylether was added slowly at –10 C with stirring. After more than 24 h at –20 C, the proteolipid precipitate was removed by centrifugation at 1,000 × *g* for 2 h at –20 C. The precipitate was easily redissolved in a small volume of chloroform-methanol (2:1) at room temperature.

**Protein determinations.** Protein was determined by the method of Lowry as modified by Bailey (3) using bovine serum albumin as a standard. Membrane samples were dissolved in 0.5 N NaOH. Proteolipid samples were solubilized by adding 2.5% sodium dodecyl sulfate in 0.5 N NaOH to the dry residue and heating at 37 C for at least 2 h. The 2% Na<sub>2</sub>CO<sub>3</sub> (Lowry reagent A) used in these assays contained 1% sodium dodecyl sulfate.

## RESULTS

**Isolation of mutants.** DCCD-resistant mutants were selected, after mutagenesis, on plates containing 5 mM DCCD and carbon sources that required oxidative phosphorylation for growth. DCCD had little effect on the rate of growth of DCCD-resistant mutants in liquid medium in contrast to the inhibitory effect on the wild type (AN180). This is shown for one mutant strain, RF-7, in Fig. 2.

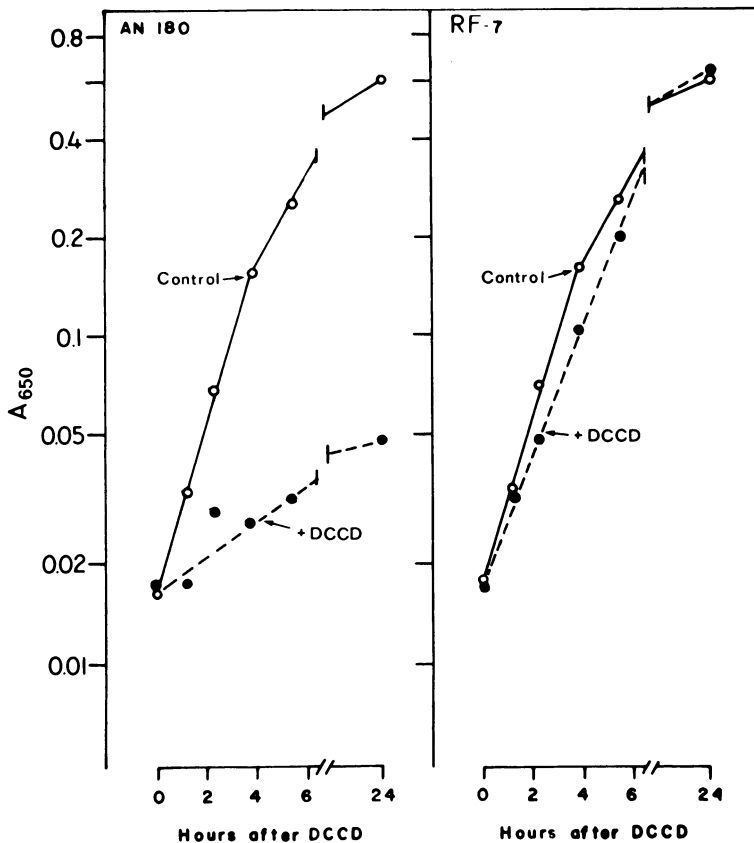

FIG. 2. Effect of DCCD on growth of wild type (AN180) and a carbodiimide-resistant mutant (RF-7) of *E. coli*. DCCD in ethanol (●) or ethanol only (○) was added to exponentially growing cultures (utilizing succinate, acetate, and malate as a carbon source) at zero time. The final concentration of DCCD was 5 mM and of ethanol was 1%. Growth was monitored with a Coleman Junior spectrophotometer. The growth curves with DCCD were corrected for an increase in turbidity (absorbance at 650 nm of 0.03) due to precipitation of DCCD. An absorbance at 650 nm of 0.1 corresponds to  $3.5 \times 10^8$  cells/ml.

Of twenty such DCCD-resistant mutant strains, only one, RF-7, had an ATPase that was significantly less sensitive to inhibition by DCCD. Higher concentrations of DCCD or prolonged incubation times were required for inhibition (Fig. 3). As expected, the degree of inhibition (for either AN180 or RF-7) was affected by the concentration of membrane protein and the temperature of the incubation mixture. As the concentration of membrane protein was increased, higher concentrations or longer times were required to achieve the same percentage of inhibition. The rate of inhibition at 0 C was roughly 1/20 that at 30 C (both rates deviating from first-order kinetics).

Mixed reconstitution experiments were performed to determine whether the DCCD resistance of RF-7 was due to a change in a component of the stripped membrane rather than a modified soluble ATPase. "Stripped mem-

branes," which retained less than 4% of the original ATPase activity, could be combined with the DCCD-insensitive soluble ATPase fractions from either AN180 or RF-7 to yield reconstituted membranes exhibiting normal activity (Table 2). The DCCD sensitivity of these reconstituted membranes is shown in Fig. 4. When the stripped membrane fraction from AN180 was complexed with soluble ATPase from either AN180 or RF-7, the reconstituted membrane-bound activity was inhibited by DCCD (Fig. 4A). Conversely, reconstitution of the RF-7 stripped membrane fraction with soluble ATPase from either RF-7 or AN180 resulted in DCCD-insensitive activity (Fig. 4B). The mutationally altered protein, responsible for the DCCD resistance of RF-7, thus resides in the stripped membrane fraction.

Labeling of the carbodiimide-reactive protein with [ $^{14}$ C]DCCD. Preliminary experi-

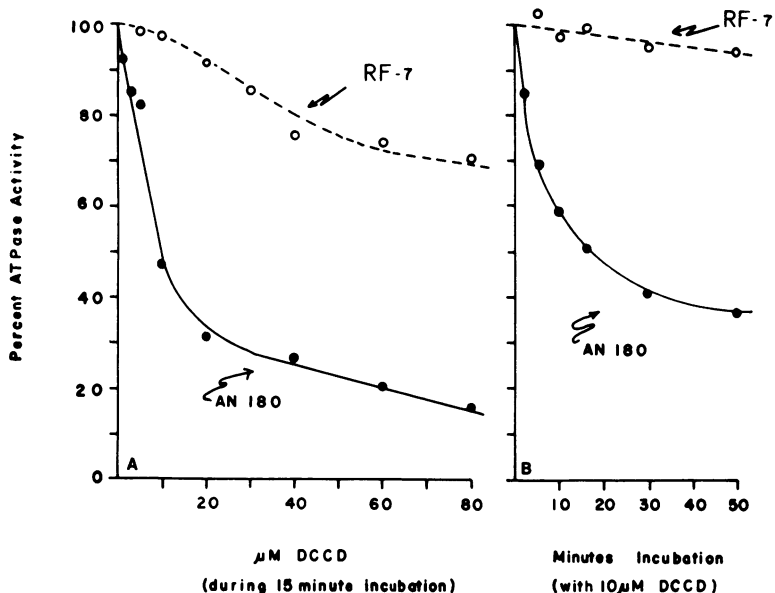

FIG. 3. DCCD inhibition of ATPase activity in AN180 and RF-7. Membrane preparations, suspended in 0.25 M sucrose-10 mM Tris-sulfate (pH 7.6)-5 mM MgSO<sub>4</sub>-0.2 mM dithiothreitol at 0.5 mg protein/ml, were incubated at 30 C with various concentrations of DCCD (A) for 15 min or for various times (B). The final concentration of ethanol was 1%. Samples were diluted 1 to 50 into the ATPase assay buffer containing 50 mM Tris-sulfate, pH 7.8, and 0.2 mM MgSO<sub>4</sub>. [ $\gamma$ -<sup>32</sup>P]ATP was added (final concentration, 0.4 mM) after a further 5-min incubation at 30 C. The assay was terminated after 5 additional min by the addition of 1 volume of ice-cold 10% (wt/vol) trichloroacetic acid. Symbols: ●, AN180; ○, RF-7.

TABLE 2. Reconstitution of hybrid stripped membrane-soluble ATPase complexes

Strain	Native membranes	Reconstitution		
		Stripped membranes	Plus soluble ATPase <sup>a</sup> from:	
			AN180	RF-7
AN180	0.82 <sup>b</sup>	0.029	0.87	0.91
RF-7	0.99	0.035	0.99	1.11

<sup>a</sup> The specific activities of the soluble ATPases were 5.20 (AN180) and 5.62 (RF-7).

<sup>b</sup> Values given are specific activity (micro-moles/minute per milligram of protein).

ments indicated that labeling of *E. coli* membranes with [<sup>14</sup>C]DCCD was much less specific than with mitochondria. Conditions were sought where maximal inhibition was observed with a minimum degree of labeling. Incubation at 0 C, although slower, minimized nonspecific labeling as analyzed by polyacrylamide gel electrophoresis in the presence of sodium dodecyl sulfate. Under the standard conditions of labeling (see above), the ATPase activity was inhibited 75 to 80% in AN180, but usually less than 10% in RF-7. Isotope dilution experiments

indicated that labeling was due to [<sup>14</sup>C]DCCD rather than a radioactive contaminant. The dodecyl sulfate polyacrylamide gel profiles of membranes from AN180 and RF-7 labeled under these conditions are shown in Fig. 5. The distribution of radioactivity was identical in all regions of the gel, except that a prominently labeled species (component I) found in AN180 was absent in RF-7. From the difference in radioactive profiles of AN180 and RF-7 in the component I region, and the known specific activity (28.1 mCi/mmol) of the DCCD, it was calculated that 0.35 ± 0.05 nmol of DCCD was incorporated into this protein species per mg of total membrane protein. The apparent molecular weight of the component I material was approximately 9,000 based on the migration of the protein standards: unreduced insulin (5,700), cytochrome c (12,300), and chymotrypsinogen A (25,000).

Reaction of [<sup>14</sup>C]DCCD with the protein species (component I) apparently leads to inhibition of the ATPase, since this protein is labeled in AN180 but not in RF-7. (This protein species will be referred to as the "specifically labeled protein" or the "specific DCCD-reactive protein.") It was therefore predicted that this specifically labeled protein would remain in the

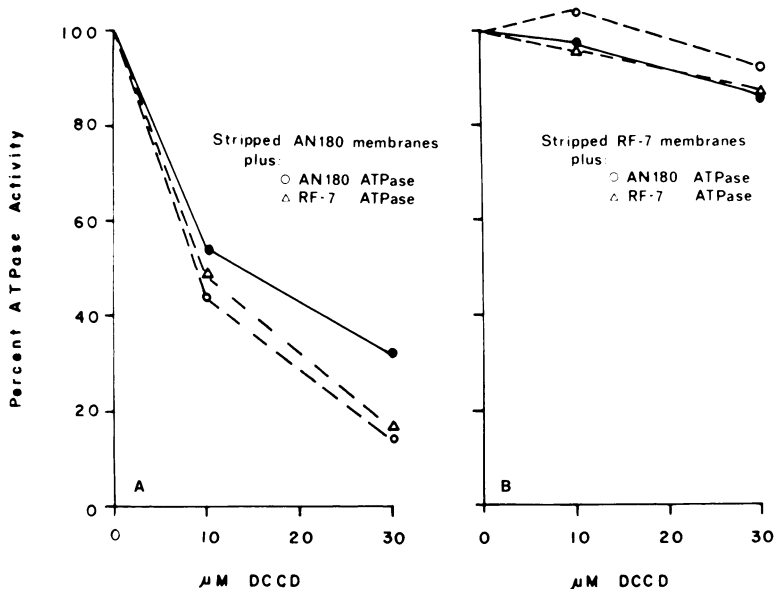

FIG. 4. DCCD sensitivity of reconstituted ATPase membrane hybrids. The reconstituted membrane-bound ATPase complexes shown in Table 2 were assayed after incubation with various concentrations of DCCD (the conditions were identical to those described in the legend to Fig. 3). (A) Stripped membranes of AN180 reconstituted with soluble ATPase of AN180 (○) or RF-7 (Δ) compared to native AN180 membranes (●). (B) Stripped membranes of RF-7 reconstituted with "soluble ATPase" of AN180 (○) or RF-7 (Δ) compared to native RF-7 membranes (●).

stripped membrane residue after removal of the ATPase. This prediction was correct, as shown in Fig. 6. The labeling of the specifically labeled protein is more striking since many of the non-specifically labeled proteins of higher molecular weight were removed by washing with 1 mM Tris buffer lacking  $Mg^{2+}$ .

The nature of the other prominently labeled low-molecular-weight material (component II), seen on gels of both AN180 and RF-7, was not determined. It may be residual [ $^{14}C$ ]DCCD or dicyclohexyl- $[^{14}C]$ urea, the likely water adduct of DCCD. The amount of radioactivity in component II was reduced by extensive washing of the membranes. However, even after many washes some radioactivity was always found at this position. Separation of component II from component I required gels with high concentrations of acrylamide and bisacrylamide. The bands were not separated on the usual gels described by Laemmli (25).

**Extraction of the DCCD-reactive protein into chloroform-methanol.** The specifically labeled protein of AN180 membranes was extractable into chloroform-methanol (2:1) as was the radioactive component II material. However, the specifically labeled protein was precipitated from chloroform-methanol with diethyl ether (see above), whereas component II remained in

the supernatant solution. The distribution of radioactivity in the chloroform-methanol-soluble, diethyl ether-precipitable material is shown in Fig. 7. In this experiment 75% of the radioactivity in proteolipid prepared from AN180 was in the specifically labeled component I. The small amount of radioactivity found in the faster migrating component II was due to residual supernatant remaining with the precipitate. (The contamination was subsequently reduced by aspiration of the remaining supernatant ether with a finely drawn tip of a Pasteur pipette.) The distribution of radioactivity in identically prepared material from RF-7 is also shown. A small amount of radioactivity was found at the position of component I. This was anticipated as the incubation with [ $^{14}C$ ] DCCD led to slight but significant (10% in this experiment) inhibition of the ATPase in RF-7 (see above).

A note of caution should be added, as the method of preparation of the proteolipid fraction is not trivial. These proteins are easily denatured on drying unless sufficient chloroform is added such that all solvents evaporate without phase separation (see above). The experiment shown in Fig. 7 was done before this was fully recognized. The radioactivity between slices 1 and 30 probably represents aggregates

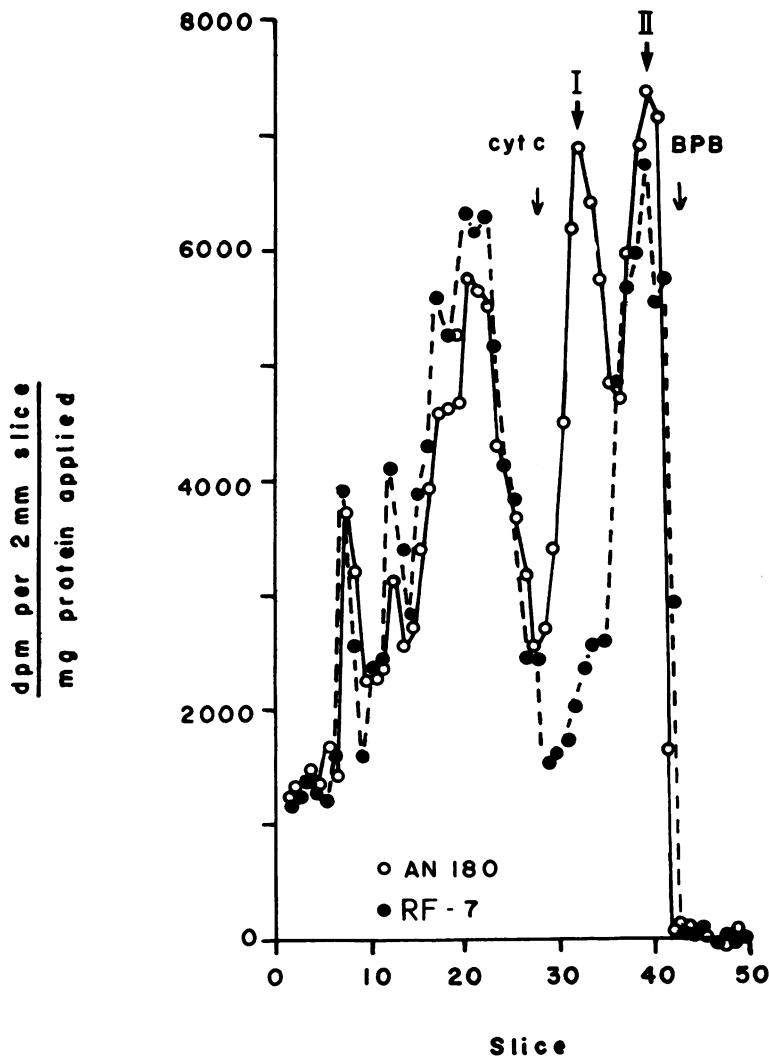

FIG. 5. Sodium dodecyl sulfate-acrylamide gel electrophoresis of whole membranes of AN180 (○) and RF-7 (●) labeled with [ $^{14}\text{C}$ ]DCCD (28.1 mCi/mmol). Samples were electrophoresed on gels (13% acrylamide, 0.41% methylenebisacrylamide) containing 0.1% sodium dodecyl sulfate, and 2-mm slices were dissolved and counted as described. The radioactivity/slice was normalized to the amount of protein (ca. 250  $\mu\text{g}$ ) applied to the gel. The position of the tracking dye (bromophenol blue) is indicated by the arrow and "BPB;" arrow marked "cyt c" indicates the position of cytochrome c on a third gel. Component I (the specifically labeled protein) and component II are discussed in the text.

of the specifically labeled component. In other experiments, the specifically labeled protein was shown to aggregate irreversibly when the proteolipid fraction was dried in a frivolous manner. However, if samples were dried exactly as described above, negligible radioactivity was observed in the higher-molecular-weight regions of the gel (e.g., Fig. 8). With this method, proteolipid fractions (from [ $^{14}\text{C}$ ]-DCCD-labeled membranes of AN180) can be reproducibly prepared in which 92 to 96% of

the total radioactivity is in the specifically labeled component.

The chloroform-methanol extraction and ether precipitation resulted in substantial purification of the specifically labeled DCCD-reactive protein in near quantitative yield. The specific activity (nanomoles of DCCD in the specifically labeled protein per milligram of total protein) of proteolipid preparations has ranged from 31 to 51 nmol/mg, as compared to 0.35 nmol/mg for washed membranes (i.e., a 90- to



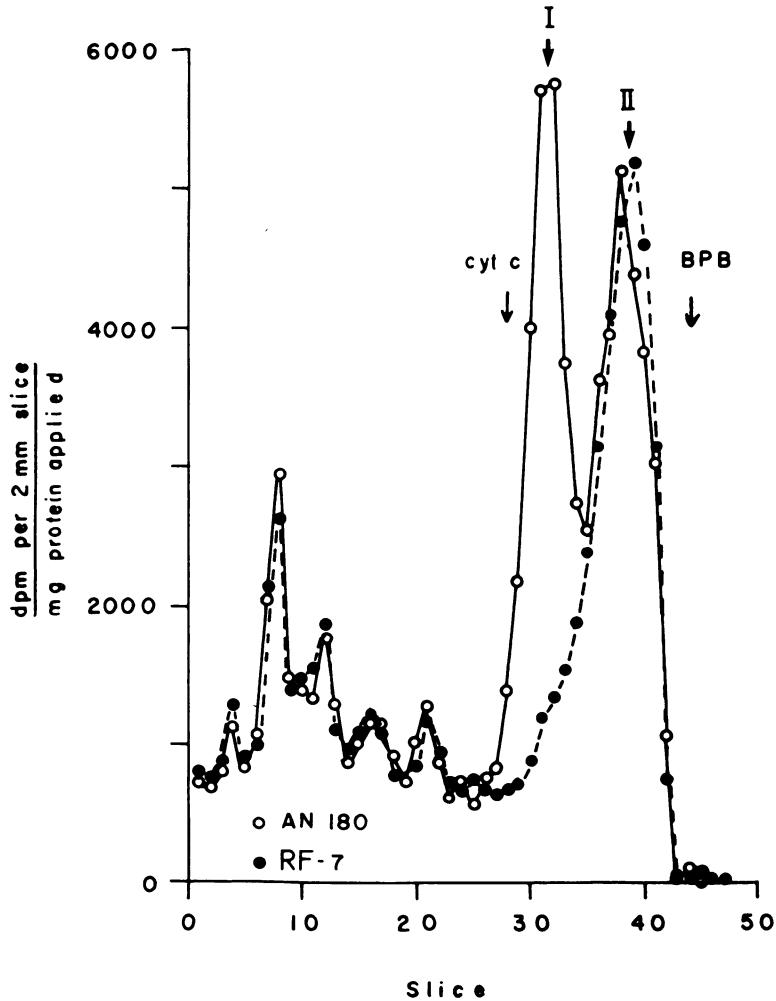

FIG. 6. Sodium dodecyl sulfate-acrylamide gel electrophoresis of [ $^{14}\text{C}$ ]DCCD-labeled stripped membrane preparations of AN180 (○) and RF-7 (●). Conditions were identical to those described in the legend to Fig. 5.

150-fold purification). A sodium dodecyl sulfate-acrylamide gel of a proteolipid preparation revealed three major and 15 minor bands and a turbid white band of phospholipid after staining with Coomassie blue (Fig. 8). One of the major bands ran coincidentally with the [ $^{14}\text{C}$ ]DCCD-labeled protein. From the scan of this gel, it was estimated that this band represents 10 to 20% of the total protein in the crude proteolipid preparation.

**Mapping of the mutation causing DCCD resistance.** Since all ATP-related energy-transduction mutants mapped to date have been co-transducible with the ATPase (*uncA401*) gene at 73.5 min on the linkage map of *E. coli* K-12, it seemed possible that the carbodiimide resist-

ance of RF-7 would be specified by a locus in this region. A P1 lysate of RF-7 was transduced into the ATPase-negative strain AN120 (*uncA401*) which cannot grow on succinate. Recombinants capable of growth on succinate were selected. More than 90% of the recombinants (256/259, 105/109, and 71/79 in three experiments) grown out on succinate were also capable of growth on succinate in the presence of DCCD, i.e., were DCCD resistant. The genes are thus very closely linked.

Four of the transductants of AN120 capable of growth on succinate were analyzed in greater detail. The transductant RF-t136, which could not grow in the presence of DCCD, had membrane ATPase activity which was easily in-

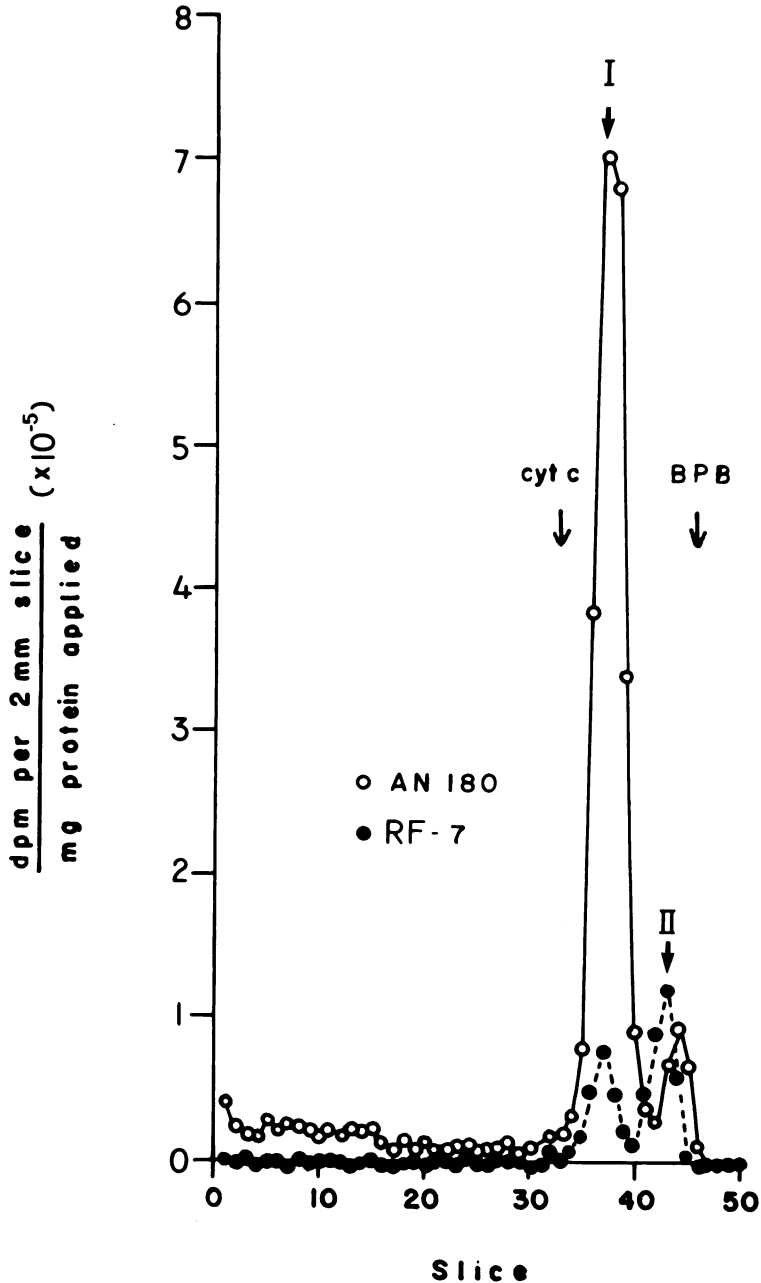

FIG. 7. Sodium dodecyl sulfate-acrylamide gel electrophoresis of <sup>14</sup>C-labeled proteolipid preparations of AN180 (○) and RF-7 (●). Membranes were extracted with chloroform-methanol (2:1), and the proteolipid fraction was precipitated from the supernatant solution with diethyl ether. Identical amounts (ca. 2 μg of protein) of proteolipid were applied to the two gels shown. The gels were run as described in the legend to Fig. 5. Component I (the specifically labeled protein) and component II are discussed in the text.

hibited by DCCD and a specific (component I) proteolipid which reacted readily with [<sup>14</sup>C]DCCD (Table 3). In contrast, three transductants showing DCCD-resistant growth had

DCCD-resistant ATPase activities and specific (component I) proteolipids which were as resistant to labeling by [<sup>14</sup>C]DCCD as the (component I) proteolipid in RF-7 (Table 3). Thus the

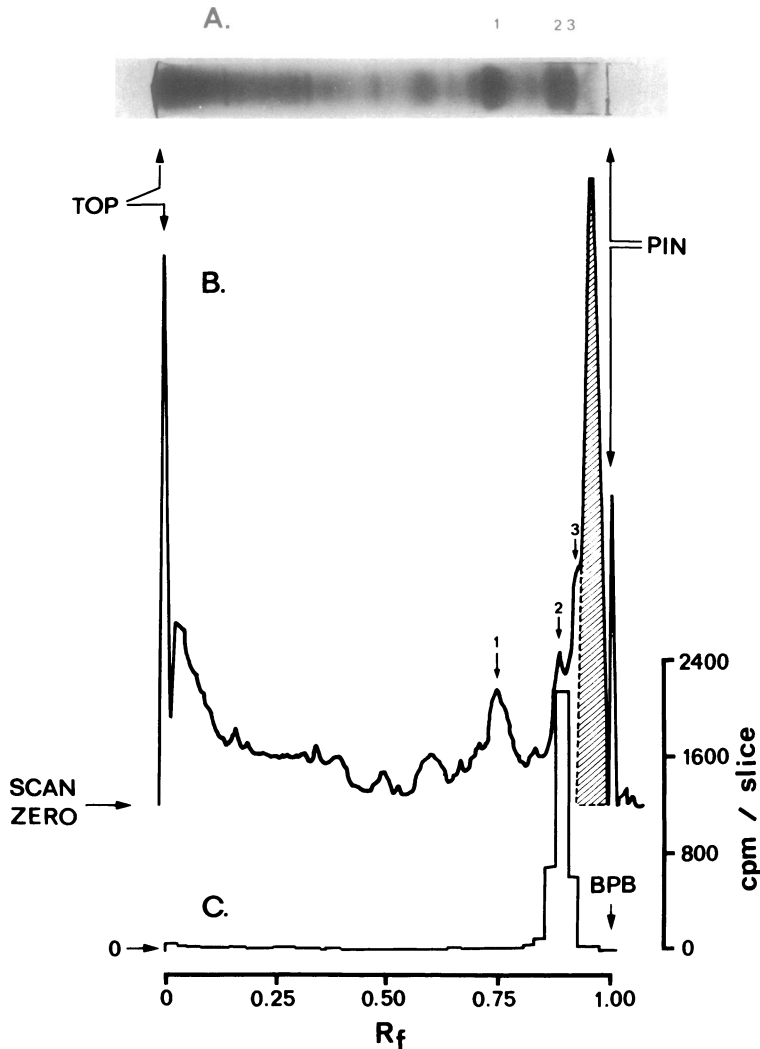

FIG. 8. Sodium dodecyl sulfate-acrylamide gel electrophoresis of a proteolipid preparation of AN180. (A) Photograph of gel stained with Coomassie brilliant blue. The three major bands are marked 1, 2, and 3. The position of the tracking dye was marked by inserting a pin dipped in India ink. The white band of phospholipid, running between band 3 and the pin mark, does not show up in the photograph. (B) Scan of same gel shown in (A). The turbidity due to the phospholipid was recorded and is indicated by the hashed area. (C) Radioactivity in the [ $^{14}\text{C}$ ]DCCD-labeled proteolipid species. The specific activity of [ $^{14}\text{C}$ ]DCCD used in this experiment was 5.02 mCi/mmol. A gel, identical to that shown in (A), was cut into 2-mm slices, and the radioactivity was determined. Samples (17  $\mu\text{g}$  of protein) were electrophoresed on gels (13% acrylamide, 0.41% methylenebisacrylamide) containing 0.2% (rather than 0.1%) sodium dodecyl sulfate, which led to better resolution of bands 2 and 3 from phospholipid.

mutation, which is closely linked to but distinct from *uncA*, results in DCCD-resistant ATPase activity and reduced proteolipid reactivity as well as DCCD-resistant growth.

#### DISCUSSION

The results of this study establish the identity of the carbodiimide-reactive protein component of the ATP energy-transducing system of

*E. coli*. The identification is based upon genetic as well as biochemical evidence. Since the DCCD sensitivity of the ATPase and DCCD reactivity of the proteolipid correlate well (in wild-type and carbodiimide-resistant strains), reaction of DCCD with the proteolipid can be causally related to inhibition of the ATPase. In contrast to previous labeling studies in mitochondria (12, 40), many proteins were labeled

TABLE 3. Properties of wild type, mutant, and transductants of the mutant

Strain	Growth in presence of DCCD (on succinate)	Sp act ( $\mu\text{mol}/\text{min}/\text{mg}$ )	ATPase of membranes			
			Sensitivity to DCCD <sup>a</sup> (% inhibition)		[ <sup>14</sup> C]DCCD <sup>b</sup>	
			10 $\mu\text{M}$	25 $\mu\text{M}$	% Inhibition	nmol of [ <sup>14</sup> C]DCCD <sup>c</sup> /mg of proteolipid
<b>Original strains</b>						
AN180	No	0.66	51	70	78	41.6
RF-7	Yes	0.96	11	16	26	13.8
<b>Transductants</b>						
RF-t136	No	0.71	59	74	81	41.1
RF-t013	Yes	1.11	8	23	28	14.3
RF-t129	Yes	0.94	21	25	29	11.4
RF-t263	Yes	0.95	20	11	27	9.0

<sup>a</sup> Conditions were as described in the legend to Fig. 3.

<sup>b</sup> Standard condition of labeling as in Materials and Methods.

<sup>c</sup> Determined from total <sup>14</sup>C radioactivity in the proteolipid fraction.

by [<sup>14</sup>C]DCCD in *E. coli* membranes. The difference in degree of nonspecific labeling may simply be due to a larger number of reactive proteins in *E. coli* membranes. Nonspecific inhibitory effects of DCCD on membrane activities of *E. coli* have been reported (39), so the reaction of DCCD with these sites would be expected. In view of the nonspecific reactions, the successful identification of the specific carbodiimide-reactive protein emphasizes the utility of combining biochemical and genetic approaches in energy transduction studies.

Although the specific (component I) proteolipid in RF-7 did not react readily with DCCD, it is not certain that the genetic lesion is in this protein, which is normally DCCD reactive. It is possible that mutations in other proteins of the ATPase-membrane complex could affect the susceptibility of this proteolipid to reaction with DCCD. The mixed reconstitution experiments do establish that the genetic lesion must have affected a protein in the "stripped membrane residue" rather than the soluble ATPase. J. F. Hare (submitted for publication) has recently reported on the extraction and partial purification of a DCCD-sensitive ATPase complex from *E. coli*. The complex contains the subunits of the soluble ATPase, the carbodiimide-reactive protein, and several other hydrophobic proteins. Since the complex prepared from RF-7 is DCCD resistant, the genetic lesion must be in one of the hydrophobic proteins found in the complex.

The mutation causing carbodiimide resistance in RF-7 lies at the "unc" locus defined by Butlin et al. (10). This is the third type of

energy-coupling mutation occurring at this locus. Mutants of the *uncA* type lack ATPase activity, but the inactive ATPase serves a role in preventing dissipation of the energized state as discussed above. Mutants of the *uncB* type have a wild-type ATPase that cannot energize the membrane because the stripped membrane fraction is defective (11). The membrane-bound ATPase of several such mutants was shown to be DCCD insensitive (19, 28), but the carbodiimide-reactive protein in at least one of these mutants (AN382, *uncB*401) reacted as readily as the protein in the wild type. (The effect of DCCD on the membrane ATPase of AN382 had not been examined previously. ATPase activity was DCCD insensitive, being inhibited by a maximum of 15% under the conditions of Fig. 3. The specific DCCD-reactive protein was labeled to the same extent as the protein in AN180 under the standard conditions of labeling [as determined by acrylamide gel electrophoresis of washed membranes].) The mutant described here, RF-7, is clearly phenotypically different from the *uncB* mutants, having a normal ATPase which is energy coupled (growth via oxidative phosphorylation) but which is DCCD resistant because of the change in reactivity of the specific proteolipid. It is possible that the proteins affected by mutation in *uncB* mutants and RF-7 are identical, i.e., allelic mutations demonstrating grossly different phenotypes. However, until the mutationally altered proteins are conclusively identified, it is proposed that the genetic locus in mutants like RF-7 be referred to as *dcc* and the specific lesion in RF-7 as *dcc-1*.

The specific DCCD-binding protein of *E. coli* appears to be quite analogous to the most prominently [<sup>14</sup>C]DCCD-labeled protein of mitochondria (4, 12, 40). Both migrate as proteins of low molecular weight on sodium dodecyl sulfate-acrylamide gels. Molecular weight estimates for the mitochondrial protein range from 10,000 to 15,000 (4, 12, 40), whereas the *E. coli* protein has an apparent molecular weight of 9,000. It is presently impossible to evaluate the significance of these differences in estimated molecular weight as small polypeptides run anomalously on these gels (41), and hydrophobic proteins would be expected to bind more dodecyl sulfate than the soluble protein standards. Cattell et al. (12) reported that the major DCCD-labeled protein of mitochondria was extractable into chloroform-methanol, as is the specific DCCD-reactive protein of *E. coli*. It therefore seems very likely that these proteins are analogous in structure and function, and a more detailed comparison seems warranted. The genetic studies here show that reaction of DCCD with this protein is directly related to inhibition of the ATPase in *E. coli* and therefore substantiate that contention for mitochondria as well (4, 12, 40). The purification and characterization of this protein is in progress.

#### ACKNOWLEDGMENTS

This investigation was performed in the laboratory of Eugene P. Kennedy. I am pleased to acknowledge the invaluable contribution he has made through advice and criticism. Thanks are also due to James Hare for helpful discussions.

The investigation was conducted during the tenure of a Damon Runyon Cancer Research Fellowship (DRF-852). The work was supported by Public Health Service grants GM-13952-09 and GM-18731-03 from the National Institute of General Medical Sciences.

#### LITERATURE CITED

- Abrams, A., J. B. Smith, and C. Baron. 1972. Carbodiimide-resistant membrane adenosine triphosphatase in mutants of *Streptococcus faecalis*. I. Studies of the mechanism of resistance. *J. Biol. Chem.* 247:1484-1488.
- Alterndorf, K., F. M. Harold, and R. D. Simoni. 1974. Impairment and restoration of the energized state in membrane vesicles of a mutant of *Escherichia coli* lacking adenosine triphosphatase. *J. Biol. Chem.* 249:4587-4593.
- Bailey, J. L. 1967. *Techniques in protein chemistry*, 2nd ed., p. 340-342. Elsevier, Amsterdam.
- Beechey, R. B., and K. J. Cattell. 1973. Mitochondrial coupling factors, p. 305-357. In D. R. Sanadi and L. Packer (ed.), *Current topics in bioenergetics*, vol. 5. Academic Press Inc., New York.
- Beechey, R. B., C. T. Holloway, I. G. Knight, and A. M. Robertson. 1966. Dicyclohexylcarbodiimide—an inhibitor of oxidative phosphorylation. *Biochem. Biophys. Res. Commun.* 23:75-80.
- Beechey, R. B., A. M. Robertson, T. Holloway, and I. G. Knight. 1967. The properties of dicyclohexylcarbodiimide as an inhibitor of oxidative phosphorylation. *Biochemistry* 6:3867-3879.
- Bragg, P. D., and C. Hou. 1972. Purification of a factor for both aerobic-driven and ATP-driven energy-dependent transhydrogenases of *Escherichia coli*. *FEBS Lett.* 28:309-312.
- Bragg, P. D., and C. Hou. 1973. Reconstitution of energy-dependent transhydrogenase in ATPase-negative mutants of *Escherichia coli*. *Biochem. Biophys. Res. Commun.* 50:729-736.
- Bulos, B., and E. Racker. 1968. Partial resolution of the enzymes catalyzing oxidative phosphorylation. XVII. Further resolution of the rutamycin sensitive adenosine triphosphatase. *J. Biol. Chem.* 243:3891-3900.
- Butlin, J. D., G. B. Cox, and F. Gibson. 1971. Oxidative phosphorylation in *Escherichia coli* K-12. Mutations affecting magnesium ion- or calcium ion-stimulated adenosine triphosphatase. *Biochem. J.* 124:75-81.
- Butlin, J. D., G. B. Cox, and F. Gibson. 1973. Oxidative phosphorylation in *Escherichia coli* K-12: the genetic and biochemical characterization of a strain carrying a mutation in the *uncB* gene. *Biochim. Biophys. Acta* 292:366-375.
- Cattell, K. J., C. R. Lindop, I. G. Knight, and R. B. Beechey. 1971. The identification of the site of action of NN'-dicyclohexylcarbodiimide as a proteolipid in mitochondrial membranes. *Biochem. J.* 125:169-177.
- Cockrell, R. S. 1973. Energy linked ion translocation in submitochondrial particles. III. Transport of monovalent cations by submitochondrial particles. *J. Biol. Chem.* 248:6828-6833.
- Cohen, G. N., and H. V. Rickenberg. 1956. Concentration specific reversible des amino acids ches *Escherichia coli*. *Ann. Inst. Pasteur Paris* 91:693-720.
- Evans, D. J., Jr. 1970. Membrane Mg<sup>2+</sup>-(Ca<sup>2+</sup>)-activated adenosine triphosphatase of *Escherichia coli*: characterization in the membrane-bound and solubilized states. *J. Bacteriol.* 104:1203-1212.
- Folch, J., and M. Lees. 1951. Proteolipides, a new type of tissue lipoproteins. Their isolation from brain. *J. Biol. Chem.* 191:807-817.
- Folch, J., M. Lees, and G. H. S. Stanley. 1957. A simple method for the isolation and purification of total lipids from animal tissues. *J. Biol. Chem.* 226:497-509.
- Futai, M., P. C. Sternweis, and L. A. Heppel. 1974. Purification and properties of reconstitutively active and inactive adenosine triphosphatase from *Escherichia coli*. *Proc. Natl. Acad. Sci. U.S.A.* 71:2725-2729.
- Gutnick, D. L., B. I. Kanner, and P. W. Postma. 1972. Oxidative phosphorylation in mutants of *Escherichia coli* defective in energy transduction. *Biochim. Biophys. Acta* 283:217-222.
- Hare, J. F., K. Olden, and E. P. Kennedy. 1974. Heterogeneity of membrane vesicles from *Escherichia coli* and their subfractionation with antibody to ATPase. *Proc. Natl. Acad. Sci. U.S.A.* 71:4843-4846.
- Harold, F. M., J. R. Baarda, C. Baron, and A. Abrams. 1969. Inhibition of membrane-bound adenosine triphosphatase and cation transport in *Streptococcus faecalis* by N,N'-dicyclohexylcarbodiimide. *J. Biol. Chem.* 244:2261-2268.
- Kanner, B. I., and D. L. Gutnick. 1972. Energy linked nicotinamide adenine dinucleotide transhydrogenase in a mutant of *Escherichia coli* K-12 lacking membrane Mg<sup>2+</sup>-Ca<sup>2+</sup>-activated adenosine triphosphatase. *FEBS Lett.* 22:197-199.
- Klein, W. L., and P. D. Boyer. 1972. Energization of active transport by *Escherichia coli*. *J. Biol. Chem.* 247:7257-7265.
- Knowles, A. F., R. J. Guillory, and E. Racker. 1971. Partial resolution of the enzymes catalyzing oxidative phosphorylation. XXIV. A factor required for the binding of mitochondrial ATPase to the inner mito-

- chondrial membrane. *J. Biol. Chem.* 246:2672-2679.
25. Laemmli, U. K. 1970. Cleavage of structural proteins during the assembly of the head of bacteriophage T4. *Nature (London)* 227:680-685.
  26. McCarthy, R. E., and E. Racker. 1967. Partial resolution of the enzymes catalyzing photophosphorylation. II. The inhibition and stimulation of phosphorylation by N,N'-dicyclohexylcarbodiimide. *J. Biol. Chem.* 242:3435-3429.
  27. Miller, J. H. 1972. Experiments in molecular genetics, p. 466. Cold Spring Harbor Laboratory, Cold Spring Harbor, New York.
  28. Nieuwenhuis, F. J. R. M., B. I. Kanner, D. L. Gutnick, P. W. Postma, and K. Vandam. 1973. Energy conservation in membranes of mutants of *Escherichia coli* defective in oxidative phosphorylation. *Biochim. Biophys. Acta* 325:62-71.
  29. Or, A., B. I. Kanner, and D. L. Gutnick. 1973. Active transport in mutants of *Escherichia coli* with alterations in the membrane ATPase complex. *FEBS Lett.* 35:217-219.
  30. Patterson, M. S., and R. C. Greene. 1965. Measurement of low energy  $\beta$ -emitters in aqueous solution by liquid scintillation counting in emulsions. *Anal. Chem.* 37:854-857.
  31. Robertson, A. M., C. T. Holloway, I. G. Knight, and R. B. Beechey. 1968. A comparison of the effects of N,N'-dicyclohexylcarbodiimide, oligomycin A and aurovertin on energy-linked reactions in mitochondria and submitochondrial particles. *Biochem. J.* 108:445-456.
  32. Roisin, M. P., and A. Kepes. 1973. The membrane ATPase of *Escherichia coli*. II. Release into solution, allopic properties and reconstitution of membrane-bound ATPase. *Biochim. Biophys. Acta* 305:249-259.
  33. Rosen, B. P. 1973.  $\beta$ -Galactoside transport and proton movements in an adenosine triphosphatase-deficient mutant of *Escherichia coli*. *Biochem. Biophys. Res. Commun.* 53:1289-1296.
  34. Rosen, B. P. 1973. Restoration of active transport in an  $Mg^{2+}$ -adenosine triphosphatase-deficient mutant of *Escherichia coli*. *J. Bacteriol.* 116:1124-1129.
  35. Rosen, B. P., and L. W. Adler. 1975. The maintenance of the energized state and its relation to active transport in *Escherichia coli*. *Biochim. Biophys. Acta* 387:23-36.
  36. Schairer, H. U., and D. Gruber. 1973. Mutants of *Escherichia coli* K12 defective in oxidative phosphorylation. *Eur. J. Biochem.* 37:282-286.
  37. Schairer, H. U., and B. A. Haddock. 1972.  $\beta$ -Galactoside accumulation in a  $Mg^{2+}$ ,  $Ca^{2+}$ -activated ATPase deficient mutant of *E. coli*. *Biochem. Biophys. Res. Commun.* 48:544-551.
  38. Senior, A. E. 1973. Structure of mitochondrial ATPase. *Biochim. Biophys. Acta* 301:249-277.
  39. Singh, A. P., and P. D. Bragg. 1974. Effect of dicyclohexylcarbodiimide on growth and membrane-mediated processes in wild-type and heptose-deficient mutants of *Escherichia coli* K-12. *J. Bacteriol.* 119:129-137.
  40. Stekhoven, F. S., R. F. Waitkus, and H. T. B. van Moerkerk. 1972. Identification of the dicyclohexylcarbodiimide-binding protein in the oligomycin-sensitive adenosine triphosphatase from bovine heart mitochondria. *Biochemistry* 11:1144-1150.
  41. Swank, R. T., and K. D. Munkres. 1971. Molecular weight analysis of oligopeptides by electrophoresis in polyacrylamide gel with sodium dodecyl sulfate. *Anal. Biochem.* 39:462-467.
  42. Tsuchiya, T., and B. P. Rosen. 1975. Restoration of active calcium transport in vesicles of an  $Mg^{2+}$ -ATPase mutant of *Escherichia coli* by wild-type  $Mg^{2+}$ -ATPase. *Biochem. Biophys. Res. Commun.* 63:832-838.
  43. VanThienen, G., and P. W. Postma. 1973. Coupling between energy conservation and active transport of serine in *Escherichia coli*. *Biochim. Biophys. Acta* 323:429-440.
  44. Weber, K., and M. Osborn. 1969. The reliability of molecular weight determinations by dodecyl sulfate-polyacrylamide gel electrophoresis. *J. Biol. Chem.* 244:4406-4412.