

Dissimilation of Carbon Monoxide to Acetic Acid by Glucose-Limited Cultures of *Clostridium thermoaceticum*

DOUGLAS R. MARTIN, ARUN MISRA, AND HAROLD L. DRAKE*

Microbial Physiology Laboratories, Department of Biology, The University of Mississippi, University, Mississippi 38677

Received 19 November 1984/Accepted 27 March 1985

Clostridium thermoaceticum was cultivated in glucose-limited media, and the dissimilation of CO to acetic acid was evaluated. We found that cultures catalyzed the rapid dissimilation of CO to acetic acid and CO₂, with the stoichiometry obtained for conversion approximating that predicted from the following reaction: $4\text{CO} + 2\text{H}_2\text{O} \rightarrow \text{CH}_3\text{CO}_2\text{H} + 2\text{CO}_2$. Growing cultures formed approximately 50 mmol (3 g) of CO-derived acetic acid per liter of culture, with the rate of maximal consumption approximating 9.1 mmol of CO consumed/h per liter of culture. In contrast, resting cells were found not to dissimilate CO to acetic acid. ¹⁴C was incorporated, with equal distribution between the carboxyl and methyl carbons of acetic acid when the initial cultivation gas phase was 100% CO, whereas ¹⁴CO₂ preferentially entered the carboxyl carbon when the initial gas phase was 100% CO₂. Significantly, in the presence of saturating levels of CO, ¹⁴CO₂ preferentially entered the methyl carbon, whereas saturating levels of CO₂ yielded ¹⁴C-derived labeling predominantly in the carboxyl carbon. These findings are discussed in relation to the path of carbon flow to acetic acid.

Clostridium thermoaceticum (12) is a homoacetate-fermenting bacterium which has been extensively studied for its unique physiological properties and potential applications (23, 25, 30, 38, 39, 42, 44, 46, 47). Historically, industrial interest in this acetogen stems from its ability to convert 1 mol of glucose in near stoichiometry to 3 mol of acetic acid. However, recent studies also document the potential of *C. thermoaceticum* to incorporate carbon monoxide (CO) into the acetic acid fermentation pool (5, 15, 16, 19), thus making this anaerobe an attractive model for studies on the anaerobic bioconversion of synthesis gas, a fossil fuel-derived mixture of CO and H₂ and a raw material for industrial chemicals (34, 47). The occurrence of hydrogenase (6) and H₂-dependent synthesis of acetic acid (19, 32, 44) reinforce the potential of this organism for synthesis gas bioconversion.

The present study was designed to assess the capability of glucose-limited cultures of *C. thermoaceticum* to catalyze the total synthesis of acetic acid from CO.

MATERIALS AND METHODS

Cultivation. *C. thermoaceticum* was cultivated in crimp-sealed, 125-ml Wheaton serum bottles (150-ml total volume) containing 40 ml of media. The bicarbonate-phosphate-buffered medium (BPM) used for maintenance of stock laboratory cultures contained the following components in grams per liter: glucose, 18.0; yeast extract (Sigma Chemical Co.), 5.0; casein hydrolysate (Sigma), 5.0; KH₂PO₄, 14.0; K₂HPO₄, 14.0; NaHCO₃, 18.0; minerals, chelators, and reducers as described previously (27); and an initial gas phase of 100% CO₂. The glucose-limited phosphate-buffered medium (GLPM) used in CO bioconversion studies was identical to BPM except glucose was decreased to 4.5 g/liter, sodium bicarbonate was omitted, and the phosphate salts were increased to 20.0 g/liter each; initial cultivation gas phases were at 2.0 to 2.5 atmospheres and were as indicated. Phosphate-buffered medium (PM) was GLPM with 18.0 g of glucose per liter. Inoculations (8%, 3.2 ml of inoculum per 40 ml of uninoculated media) were made from mid- to late-log-

phase cells, and cultures were incubated at 55°C and shaken at 80 cycles per min. Stock cultures were maintained in BPM, and GLPM was always inoculated from BPM cultures, resulting in slight carry-over of bicarbonate and residual glucose. Resting cell studies were performed in nitrogen-deficient medium (NDM) as described previously (27).

Analytical procedures. Growth was quantitated as previously described at 600 nm with a Bausch & Lomb Spectronic 88 spectrophotometer (27), and the pH of the fermentation liquor was measured with a Beckman 3500 pH meter. Glucose was measured with hexokinase-glucose 6-phosphate dehydrogenase (7; Biochemica Information, vol. I, p. 113-114, 1973, Boehringer Mannheim GmbH, Mannheim, West Germany).

H₂ and CO were measured by using a Hewlett Packard 5970A gas chromatograph equipped with stainless steel column (2 m by 2 mm) containing Porapak Q 20-100. The chromatographic conditions were as follows: injection port, 175°C; column oven, isothermal at 60°C; thermal conductivity detector, 150°C; 100% N₂ carrier gas at a flow rate of 20 ml/min. CO₂ was measured under identical conditions with a stainless steel column (2 m by 2 mm) containing molecular sieve 13× 60-80. Solubilities of H₂, CO, and CO₂ were calculated from standard solubility tables (22), and the amounts produced or consumed were calculated by taking into account both gas and liquid phases.

Acetic acid was measured by either the acetate kinase assay (36) or by gas chromatography; both procedures yielded equivalent results. Gas chromatographic analysis of acetic acid was performed under the following conditions: column, stainless steel (1 m by 2 mm) containing OV-101; injection port, 225°C; column oven, isothermal at 140°C; flame ionization detector, 350°C; 100% N₂ carrier gas at a flow rate of 20 ml/min. Cell-free fermentation liquor was acidified with an equal volume of 25% phosphoric acid before injection of a 0.1-μl sample for analysis of acetic acid. Formic acid was determined colorimetrically (20).

¹⁴C-acetic acid was purified as previously described (15) and degraded by the azide decarboxylation method (33). The authenticity of the degradation procedure was confirmed with known [¹⁻¹⁴C] and [²⁻¹⁴C]acetic acid. ¹⁴CO was gener-

* Corresponding author.

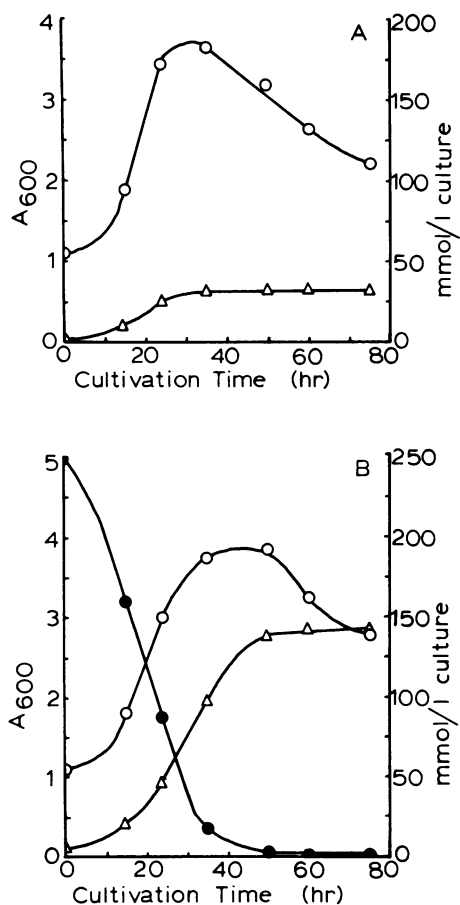

FIG. 1. Growth of *C. thermoaceticum* in GLPM. Initial cultivation gas phases: (A) CO₂ (initial pH 6.6, final pH 5.9); (B) CO (initial pH 6.8, final pH 5.7). In panel A, CO₂ production shown was that observed above the initial 100% CO₂ gas phase. Symbols: ○, growth (A_{600} is absorbance at 600 nm); Δ, CO₂; ●, CO.

ated from ¹⁴C-formate (sodium salt) (13). Radioactivity was determined by liquid scintillation with a Beckman LS-6800 liquid scintillation counter, and counts were corrected for quench and background. ¹⁴C-formic acid, [U-¹⁴C]glucose, and [1-¹⁴C]acetic acid were obtained from ICN Chemical and Radioisotope Division, and [2-¹⁴C]acetic acid and NaH¹⁴CO₃ were obtained from Research Products International.

RESULTS

Development of GLPM for studies on CO utilization. BPM was found unsuitable for the study of CO utilization since the high concentration of bicarbonate in BPM (i) yielded inhibitory alkaline pHs when non-CO₂ cultivation gas phases were utilized and (ii) produced significant quantities of bicarbonate-derived CO₂ in non-CO₂ cultures, thus making less accurate assessment of the CO-derived product profile. Likewise, although we subsequently demonstrated that CO was consumed by PM cultures, the high concentration of glucose-derived acetic acid in PM fermentations did not facilitate reliable appraisal of CO-derived acetic acid and other CO-derived products.

In effort to circumvent these difficulties, GLPM was developed by decreasing the amount of glucose in PM by 75% to 4.5 g/liter. CO was observed to be rapidly consumed under these conditions during log growth, the rate of maxi-

mal CO consumption approximating 9.1 mmol of CO consumed per h/liter of culture (Fig. 1).

Product profiles with GLPM. In homoacetate fermentation, glucose is converted to acetic acid according to the following reaction:

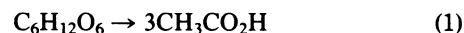

Thus, during heterotrophic fermentation, there is total conservation of both carbon and reductant in acetic acid. This is not possible in the autotrophic synthesis of acetic acid from CO since for every mole of acetic acid synthesized from CO, 2 mol of CO must be converted to CO₂ to generate the reductant required for synthesis of methyltetrahydrofolate, the precursor of the methyl group of acetic acid (9, 15). Thus, the theoretical stoichiometry for CO bioconversion is:



Table 1 outlines typical product profiles obtained when *C. thermoaceticum* was cultivated in GLPM. When the initial cultivation gas phase was 100% CO₂ (culture A), 2.1 mol of acetic acid was produced per mol of glucose consumed. This was less than the theoretical maximum of 3, which has recently been approached in pH-controlled batch cultures (39, 42), and also lower than the 2.3 to 2.7 typically observed in standard batch culture (12). Indeed, PM fermentations yielded stoichiometries approximating 2.5 (data not shown). Since GLPM contains 75% less glucose, it is possible that a larger percentage of glucose-derived carbon is shunted towards biosynthesis. Additionally, as illustrated in Fig. 1, CO₂ production was consistently observed in GLPM (and in PM, see ref. 17) and accounted for approximately 17% of the consumed carbon from glucose. Thus, the percent carbon recovered from glucose as acetic acid and CO₂ in culture A approximated 90%, indicating that 10% of glucose-derived carbon may reside as biomass after batch fermentation in GLPM. In support of this possibility, when [U-¹⁴C]glucose was utilized in GLPM fermentations, approximately 7% of the label was accounted for in biomass after fermentation (data not shown).

In contrast, under CO (Table 1, culture B), production of acetic acid and CO₂ increased significantly. Taking into account the amount of glucose-derived CO₂ and acetic acid (culture A) and correcting for the fact that glucose consumption in culture B was only 84.4% that of culture A, the following stoichiometry (for carbon) was observed for CO conversion in GLPM batch fermentation:

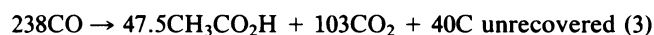

Thus, whereas it was predicted (above) that 50% of CO-derived carbon would be converted to acetic acid, under these conditions only 40% conversion was observed. Likewise, the amount of carbon recovered as CO₂ was also slightly less

TABLE 1. Product profiles with GLPM^a

Culture	Gas phase	mmol of the following per liter of culture:					Ratio of acetic acid/glucose
		CO	CO ₂ ^b	Glucose	Acetic acid	H ₂	
A	CO ₂	0	+32	-32	+67	+1	2.1
B	CO	-238	+130	-27	+104	+15	3.8

^a Fermentation time, 75 h. +, Production; -, consumption. Formic acid was not a detectable fermentation product in either A or B.

^b Above that at time zero.

TABLE 2. Distribution of ^{14}C in acetic acid^a

Culture	Gas phase	Label	cpm degraded	Distribution in acetic acid		cpm recovered (%)
				Carboxyl (%) ^b	Methyl (%) ^b	
C	CO	^{14}CO	15,000	7,145 (52.0)	6,595 (48.0)	91.6
D	CO_2	$^{14}\text{CO}_2$	6,000	3,461 (62.9) ^c	2,041 (37.1)	91.7
E	CO	$^{14}\text{CO}_2$	5,500	2,056 (39.6)	3,136 (60.4)	94.4
F	CO_2	^{14}CO	10,000	9,010 (99.4)	56 (0.6)	90.1
G	CO_2	$\text{H}^{14}\text{CO}_2\text{H}$	4,100	512 (13.0)	3,424 (87.0)	96.0

^a Fermentation bottles were supplemented in early log phase with either 0.2 mmol of ^{14}CO containing 2.9×10^6 cpm, 0.1 μmol of $\text{NaH}^{14}\text{CO}_3$ containing 2.0×10^6 cpm, or 7.5 μmol of $\text{Na}^{14}\text{CO}_2\text{H}$ containing 3.5×10^6 cpm, and after fermentation, the ^{14}C -labeled acetic acid was purified (15) from acidified liquors (to volatilize dissolved carbonates) from which cells had been removed by centrifugation.

^b Percent of total recovered in degradation.

^c Distributions up to 74% in the carboxyl carbon have been observed.

than predicted, the percent total carbon recovered as acetic acid and CO_2 being 83%. The theoretical mass yield is 53.6 weight percent yield of acetic acid from CO [60/(4 × 28)]. In the bioconversion under GLPM conditions, this yield was 42.8 weight percent [(60 × 47.5)/(28 × 238)]. Nearly identical stoichiometries have recently been reported from whole-cell studies with *Eubacterium limosum* (14).

Consistent with previous findings, H_2 was produced by CO cultures (17, 27). However, whereas resting cells are competent in H_2 formation (27), no appreciable conversion of CO to acetic acid was observed with resting cells (data not shown). It was therefore concluded that under these conditions growth was prerequisite for acetogenic conversion of CO to acetic acid.

^{14}C distribution studies. To confirm the total synthesis of acetic acid from CO, ^{14}C tracer studies were performed (Table 2). When the initial cultivation gas phase was 100% ^{14}CO , the label in acetic acid was equally distributed between the carboxyl and methyl carbons (culture C), thus demonstrating total synthesis of acetic acid from CO in GLPM fermentation. In close agreement with the stoichiometry predicted from reaction 2, 46.3% of the initial ^{14}CO was recovered in acetic acid. Minimal incorporation (1.8%) of ^{14}CO into biomass was observed.

As shown in culture D, when the initial cultivation gas phase was 100% CO_2 , $^{14}\text{CO}_2$ preferentially entered the carboxyl carbon of acetic acid. It was therefore concluded that the route for incorporation of CO into acetic acid is dissimilar to that of CO_2 and that CO-derived CO_2 is not the (sole) precursor for both carbons of CO-derived acetic acid.

When the initial cultivation gas phase was 100% CO and the culture was supplemented with trace levels of $^{14}\text{CO}_2$ in early log phase (culture E), preferential labeling of the methyl rather than the carboxyl carbon of acetic acid was observed. Under these conditions, it is believed that CO-derived reductant drives the reduction of CO_2 to methyltetrahydrofolate by the sequential actions of formate dehydrogenase, formyltetrahydrofolate synthetase, methenyltetrahydrofolate cyclohydrolase, methylenetetrahydrofolate dehydrogenase, and methylenetetrahydrofolate reductase (1, 10, 11, 23, 28, 31, 45). In the absence of high concentrations of CO, this reductive pressure on CO_2 does not exist.

In contrast, when the initial cultivation gas phase was 100% CO_2 and the culture was supplemented with trace levels of ^{14}CO in early log phase (culture F), incorporation was exclusively in the carboxyl carbon of acetic acid. Thus, in the presence of saturating levels of CO_2 , CO (i) preferentially enters the carboxyl carbon, or (ii) becomes diluted out en route to the methyl carbon, or (iii) both.

Consistent with previous investigations which demon-

strated that formate is a better precursor of the methyl group of acetic acid (21, 24), [^{14}C]formic acid almost exclusively entered the methyl carbon of acetic acid in GLPM fermentation (culture G).

DISCUSSION

From these findings, we concluded that glucose-limited cultures of *C. thermoaceticum* catalyze the total synthesis of acetic acid from CO, and that growth is required for this dissimilation since resting cells were not competent in bioconversion. With shaken batch cultures, CO-derived acetic acid production approximated 3 g per liter of culture. Dissimilation may be enhanced by chemostat cultivation.

C. thermoaceticum catalyzes a rapid exchange between CO_2 and the carboxyl group of pyruvate (9, 37). Thus, $^{14}\text{CO}_2$ cultures will give rise to carboxyl-labeled pyruvate. Theoretically, this would yield equally labeled acetic acid as outlined in the following reactions:

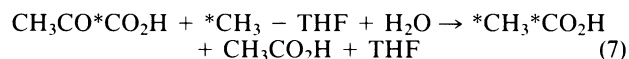
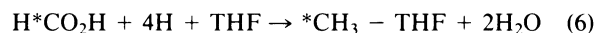
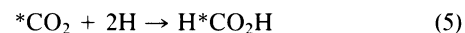

Sum:



where THF is tetrahydrofolate. However, as seen in Table 2, culture D, $^{14}\text{CO}_2$ cultures did not yield equally labeled acetic acid. This finding, i.e., that glucose-fermenting cultures incorporate CO_2 preferentially into the carboxyl carbon of acetic acid, is consistent with those previously reported (2, 43) but inconsistent with that predicted in reactions 4 through 8.

We believe this apparent discrepancy indicates that the flow of glucose-derived carbon to the carboxyl and methyl sides of acetic acid is dissimilar at the level of pyruvate; this is illustrated in Fig. 2. Studies with purified enzymes clearly demonstrate that the enzyme catalyzing the exchange between CO_2 and the carboxyl carbon of pyruvate is part of the multienzyme system which synthesizes acetyl-coenzyme A (CoA) from pyruvate and methyltetrahydrofolate (8, 9). Thus, it is possible that the pyruvate which undergoes transcarboxylation (i.e., the "carboxyl path" pyruvate) is more susceptible to exchange with CO_2 than is the pyruvate which undergoes decarboxylation (i.e., the "methyl path" pyruvate). Since the transcarboxylation and decarboxylation reactions are quite different, it stands to reason that they

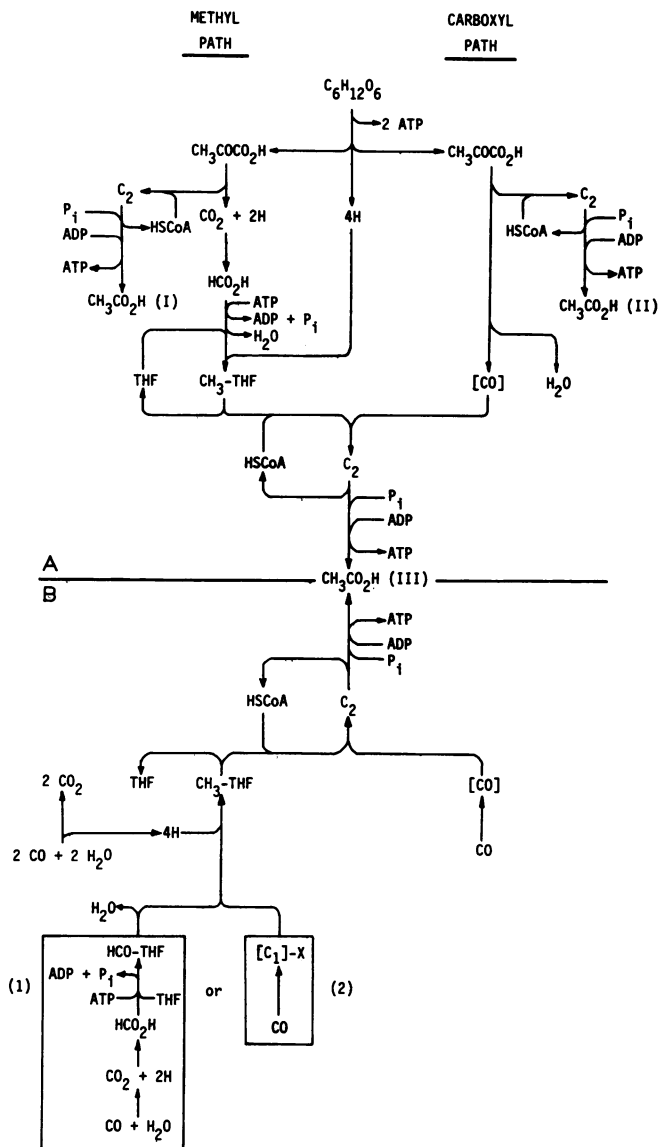

FIG. 2. Glucose-dependent (A) and CO-dependent (B) synthesis of acetic acid by *C. thermoaceticum*. C₂ is acetyl-CoA, THF is tetrahydrofolate, HSCoA is CoA, and X is a postulated one-carbon carrier (THF?). [CO] and [C₁] are one-carbon intermediates, the natures of which may or may not be equivalent. Routes 1 and 2 for generation of CO-derived CH₃-THF are enclosed in boxes.

are catalyzed by pyruvate enzymes which display either absolute or kinetic differences with regard to pyruvate-CO₂ exchange.

Two possible routes are depicted in Fig. 2 for the flow of CO-derived carbon in the methyl path. Route 1 predicts that CO passes through free CO₂, whereas route 2 does not. Assuming CO passed through free CO₂ en route to the methyl side of acetic acid (CO does not pass through free CO₂ en route to the carboxyl carbon [15]), CO-derived label would become susceptible to exchange with the pyruvate derived from unlabeled glucose and thus yield unequally labeled acetic acid, i.e., acetic acid with a higher percentage of CO-derived carbon in the carboxyl group. This was not observed (culture C) and would seem to favor the idea that, in vivo, CO may not exclusively pass through free CO₂ en

route to the methyl side of acetic acid. Such a pathway would be in contrast to that of *Butyribacterium methylotrophicum* in which CO appears to pass through free CO₂ en route to the methyl carbon of acetic acid (18) as well as the carboxydrotrophs (29) and CO-utilizing phototrophs (41) which assimilate CO-derived CO₂ via the ribulosebiphosphate cycle. It is of further interest to note that current evidence indicates that methanogenic synthesis of acetic acid is mechanistically similar to that of acetogens (40).

However, it has been demonstrated with purified enzymes that CO dehydrogenase does not couple with tetrahydrofolate enzymes, suggesting that formate dehydrogenase is required to mediate passage of CO dehydrogenase-generated CO₂ to the level of formate which subsequently enters the tetrahydrofolate pathway by formyltetrahydrofolate synthetase (35). This would be consistent with route 1 but would appear to not be totally supported by the observed results. Clearly, neither route 1 nor 2 can be ruled out by studies to date, and both may occur in vivo.

CO dehydrogenase is proposed to supply an enzyme bound C₁ intermediate in the transcarboxylation step (9, 15, 32, 44) required for the synthesis of acetic acid III (Fig. 2), and inspection of the role proposed for CO dehydrogenase favors the concept of the enzyme existing in complex with other components of the acetyl-CoA synthesizing system. With CO dehydrogenase as an integral part of this enzyme complex, it is conceivable that CO may exclusively enter the carboxyl carbon of acetic acid when only trace levels of CO are present (culture F). Significantly, studies with ¹⁴CO-supplemented H₂-CO₂ (80:20) cultivated *Acetobacterium woodii* yielded identical results, i.e., CO (at 1% initial concentration of cultivation gas phase) predominately entered the carboxyl carbon of acetic acid (4). A recent study with *C. thermoaceticum* confirms this labeling pattern when traces of ¹⁴CO are cofermented in CO₂-saturated glucose cultures (3).

In addition to the pyruvate-CO₂ exchange, an exchange between CO and carbon 1 of acetyl-CoA has also been observed with purified enzymes and cell extracts (15, 35). Such an exchange should favor the formation of carboxyl-labeled acetic acid during cofermentation of ¹⁴CO and unlabeled glucose. Because this was not observed (culture C), it is likely that CO uptake is concomitant with CO dissimilation, and that significant concentrations of free CO do not exist intracellularly. Hence, the CO-acetyl-CoA exchange may not occur appreciably in vivo. That CO is not lethal to *C. thermoaceticum* and that CO dehydrogenase constitutes a large portion (2%) of the soluble protein in *C. thermoaceticum* (35), substantiates possible CO dehydrogenase-dependent detoxification of CO.

A recent study demonstrated that *C. thermoaceticum* could grow at the expense of CO (19). However, the undefined medium utilized to cultivate the organism contained high levels of organic carbon and the true autotrophic potentials of *C. thermoaceticum* remained undefined. Subsequent work with a defined minimal medium showed that glucose could serve as the sole source of carbon and energy (26), thus demonstrating that *C. thermoaceticum* has considerable anabolic potential. The present study further documents the potential of this acetogen to catalyze the total autotrophic synthesis of acetic acid from CO. Whether the organism can grow autotrophically with CO as the sole carbon and energy source remains to be shown.

Significantly, route 1 (Fig. 2B) predicts that autotrophic conversion of CO to acetic acid would yield no net gain of ATP via substrate-level phosphorylation. Autotrophic growth with CO would therefore appear to necessitate either

additional sites of ATP synthesis (e.g., via electron transport phosphorylation) or nonstoichiometric consumption of ATP during the synthesis of the methyl group (as might be envisioned in route 2). Owing to the difficulty in assessing accurately the intracellular kinetics of exchange reactions inherent to *C. thermoaceticum*, elucidation of the autotrophic flow of carbon in this acetogen will require further studies at both the whole-cell and enzyme level.

ACKNOWLEDGMENTS

This investigation was supported by grants from the Gulf Research and Development Company and the University of Mississippi.

LITERATURE CITED

- Andreesen, J. R., A. Schaupp, C. Neurauter, A. Brown, and L. G. Ljungdahl. 1973. Fermentation of glucose, fructose, and xylose by *Clostridium thermoaceticum*: effect of metals on growth yield, enzymes, and the synthesis of acetate from CO₂. *J. Bacteriol.* **114**:743-757.
- Barker, H. A., and M. D. Kamen. 1945. Carbon dioxide utilization in the synthesis of acetic acid by *Clostridium thermoaceticum*. *Proc. Natl. Acad. Sci. U.S.A.* **31**:219-225.
- Diekert, G., M. Hansch, and R. Conrad. 1984. Acetate synthesis from 2 CO₂ in acetogenic bacteria: is carbon monoxide an intermediate? *Arch. Microbiol.* **138**:224-228.
- Diekert, G., and M. Ritter. 1983. Carbon monoxide fixation into the carboxyl group of acetate during growth of *Acetobacterium woodii* on H₂ and CO₂. *FEMS Microbiol. Lett.* **17**:299-302.
- Diekert, G. B., and R. K. Thauer. 1978. Carbon monoxide oxidation by *Clostridium thermoaceticum* and *Clostridium formicoaceticum*. *J. Bacteriol.* **136**:597-606.
- Drake, H. L. 1982. Demonstration of hydrogenase in extracts of the homoacetate-fermenting bacterium *Clostridium thermoaceticum*. *J. Bacteriol.* **150**:702-709.
- Drake, H. L., N. H. Goss, and H. G. Wood. 1979. A new, convenient method for the rapid analysis of inorganic pyrophosphate. *Anal. Biochem.* **94**:117-120.
- Drake, H. L., S.-I. Hu, and H. G. Wood. 1980. Purification of carbon monoxide dehydrogenase, a nickel enzyme from *Clostridium thermoaceticum*. *J. Biol. Chem.* **255**:7174-7180.
- Drake, H. L., S.-I. Hu, and H. G. Wood. 1981. Purification of five components from *Clostridium thermoaceticum* which catalyze synthesis of acetate from pyruvate and methyltetrahydrofolate. Properties of phosphotransacetylase. *J. Biol. Chem.* **256**:11137-11144.
- Durfor, C. N., P. J. Wetherbee, J. C. Deaton, and E. I. Solomon. 1983. Characterization and spectroscopic properties of reduced Mo and W formate dehydrogenase from *C. thermoaceticum*. *Biochem. Biophys. Res. Commun.* **115**:61-67.
- Elliott, J. I., and L. G. Ljungdahl. 1982. Chemical modification of cysteine and tyrosine residues in formyltetrahydrofolate synthetase from *Clostridium thermoaceticum*. *Arch. Biochem. Biophys.* **215**:245-252.
- Fontaine, F. E., W. H. Peterson, E. McCoy, M. J. Johnson, and G. J. Ritter. 1942. A new type of glucose fermentation by *Clostridium thermoaceticum* n.sp. *J. Bacteriol.* **43**:701-715.
- Fuchs, G., U. Schnitker, and R. K. Thauer. 1974. Carbon monoxide oxidation by growing cultures of *Clostridium pasteurianum*. *Eur. J. Biochem.* **49**:111-115.
- Genthner, B. R. S., and M. P. Bryant. 1982. Growth of *Eubacterium limosum* with carbon monoxide as the energy source. *Appl. Environ. Microbiol.* **43**:70-74.
- Hu, S.-I., H. L. Drake, and H. G. Wood. 1982. Synthesis of acetyl coenzyme A from carbon monoxide, methyltetrahydrofolate, and coenzyme A by enzymes from *Clostridium thermoaceticum*. *J. Bacteriol.* **149**:440-448.
- Hu, S.-I., E. Pezacka, and H. G. Wood. 1984. Acetate synthesis from carbon monoxide by *Clostridium thermoaceticum*. Purification of the corrinoid protein. *J. Biol. Chem.* **259**:8892-8897.
- Kellum, R., and H. L. Drake. 1984. Effects of cultivation gas phase on hydrogenase of the acetogen *Clostridium thermoaceticum*. 1984. *J. Bacteriol.* **160**:466-469.
- Kerby, R., W. Niemczura, and J. G. Zeikus. 1983. Single-carbon catabolism in acetogens: analysis of carbon flow in *Acetobacterium woodii* and *Butyrivacterium methylotrophicum* by fermentation and ¹³C nuclear magnetic resonance measurement. *J. Bacteriol.* **155**:1208-1218.
- Kerby, R., and J. G. Zeikus. 1983. Growth of *Clostridium thermoaceticum* on H₂/CO₂ or CO as energy source. *Curr. Microbiol.* **8**:27-30.
- Lang, E., and H. Lang. 1972. Spezifische Farbreaktion zum Direkten Nachweis der Ameisensäure. *Z. Anal. Chem.* **260**:8-10.
- Lentz, K., and H. G. Wood. 1955. Synthesis of acetate from formate and carbon dioxide by *Clostridium thermoaceticum*. *J. Biol. Chem.* **215**:645-654.
- Linke, W. F. 1958. Solubilities of inorganic and metal organic compounds. American Chemical Society, Washington, D.C.
- Ljungdahl, L. G. 1983. Formation of acetate using homoacetate fermenting anaerobic bacteria, p. 219-248. *In* D. L. Wise (ed.), *Organic chemicals from biomass*. Benjamin/Cummings Publishing Co., Inc., Menlo Park, Calif.
- Ljungdahl, L. G., and H. G. Wood. 1969. Total synthesis of acetate from CO₂ by heterotrophic bacteria. *Annu. Rev. Microbiol.* **23**:515-538.
- Ljungdahl, L. G. and H. G. Wood. 1982. Acetate biosynthesis, p. 165-202. *In* D. Dolphin (ed.), *B₁₂*, vol II. Wiley-Interscience, New York.
- Lundie, L. L., Jr., and H. L. Drake. 1984. Development of a minimally defined medium for the acetogen *Clostridium thermoaceticum*. *J. Bacteriol.* **159**:700-703.
- Martin, D. R., L. L. Lundie, R. Kellum, and H. L. Drake. 1983. Carbon monoxide-dependent evolution of hydrogen by the homoacetate-fermenting bacterium *Clostridium thermoaceticum*. *Curr. Microbiol.* **8**:337-340.
- Mayer, F., J. I. Elliott, D. Sherod, and L. G. Ljungdahl. 1982. Formyltetrahydrofolate synthetase from *Clostridium thermoaceticum*. An electron microscopic study and specific interaction of the enzyme with ATP and ADP. *Eur. J. Biochem.* **124**:397-404.
- Meyer, O., and H. G. Schlegel. 1983. Biology of aerobic carbon monoxide oxidizing bacteria. *Annu. Rev. Microbiol.* **37**:277-310.
- Ng, T. K., R. M. Busche, C. C. McDonald, and R. W. F. Hardy. 1983. Production of feedstock chemicals. *Science* **219**:733-740.
- O'Brien, W. E., J. M. Brewer, and L. G. Ljungdahl. 1973. Purification and characterization of thermostable 5,10-methylenetetrahydrofolate dehydrogenase from *Clostridium thermoaceticum*. *J. Biol. Chem.* **248**:403-408.
- Pezacka, E., and H. G. Wood. 1984. The synthesis of acetyl-CoA by *Clostridium thermoaceticum* from carbon dioxide, hydrogen, coenzyme A and methyltetrahydrofolate. *Arch. Microbiol.* **137**:63-69.
- Phares, E. 1951. Degradation of labeled propionic and acetic acids. *Arch. Biochem. Biophys.* **33**:173-178.
- Pruett, R. L. 1981. Synthesis gas: a raw material for industrial chemicals. *Science* **211**:11-16.
- Ragsdale, S. W., J. E. Clark, L. G. Ljungdahl, L. L. Lundie, and H. L. Drake. 1983. Properties of purified carbon monoxide dehydrogenase from *Clostridium thermoaceticum*, a nickel, iron-sulfur protein. *J. Biol. Chem.* **258**:2364-2369.
- Rose, I. A. 1955. Acetate kinase of bacteria (acetokinase). *Methods Enzymol.* **1**:591-595.
- Schulman, J., R. K. Ghambeer, L. G. Ljungdahl, and H. G. Wood. 1973. Total synthesis of acetate from CO₂. VII. Evidence with *Clostridium thermoaceticum* that the carboxyl of acetate is derived from the carboxyl of pyruvate by transcarboxylation and not by fixation of CO₂. *J. Biol. Chem.* **248**:6255-6261.
- Schwartz, R. D., and F. A. Keller, Jr. 1982. Isolation of a strain of *Clostridium thermoaceticum* capable of growth and acetic acid production at pH 4.5. *Appl. Environ. Microbiol.* **43**:117-123.
- Schwartz, R. D., and F. A. Keller, Jr. 1982. Acetic acid production by *Clostridium thermoaceticum* in pH-controlled batch fermentations at acidic pH. *Appl. Environ. Microbiol.* **43**:1385-1392.

40. Stupperich, E., and G. Fuchs. 1984. Autotrophic synthesis of activated acetic acid from two CO₂ in *Methanobacterium thermoaceticum*. II. Evidence for different origins of acetate carbon atoms. Arch. Microbiol. **139**:14-20.
41. Uffen, R. L. 1983. Metabolism of carbon monoxide by *Rhodospseudomonas gelatinosa*: cell growth and properties of the oxidation system. J. Bacteriol. **155**:956-965.
42. Wang, G., and D. I. C. Wang. 1984. Elucidation of growth inhibition and acetic acid production by *Clostridium thermoaceticum*. Appl. Environ. Microbiol. **47**:294-298.
43. Wood, H. G. 1952. A study of carbon dioxide fixation by mass determination of the types of C¹³-acetate. J. Biol. Chem. **194**:905-931.
44. Wood, H. G., H. L. Drake, and S.-I. Hu. 1982. Studies with *Clostridium thermoaceticum* and the resolution of the pathway used by acetogenic bacteria that grow on carbon monoxide or carbon dioxide and hydrogen, p. 29-56. Proceedings of Biochemistry Symposia. Annual Reviews, Inc., Palo Alto, Calif.
45. Yamamoto, I., T. Saiki, S.-M. Liu, and L. G. Ljungdahl. 1983. Purification and properties of NADP-dependent formate dehydrogenase from *Clostridium thermoaceticum*, a tungsten-selenium-iron protein. J. Biol. Chem. **258**:1826-1832.
46. Zeikus, J. G. 1980. Chemical and fuel production by anaerobic bacteria. Annu. Rev. Microbiol. **34**:423-464.
47. Zeikus, J. G. 1983. Metabolism of one-carbon compounds by chemotrophic anaerobes. Adv. Microb. Physiol. **24**:215-299.