

Comparison of the Carbohydrate-Binding Specificities of Cholera Toxin and *Escherichia coli* Heat-Labile Enterotoxins LTh-I, LT-IIa, and LT-IIb

SHINJI FUKUTA,¹ JOHN L. MAGNANI,¹ EDDA M. TWIDDY,² RANDALL K. HOLMES,^{2*} AND VICTOR GINSBURG¹

Laboratory of Structural Biology, National Institute of Diabetes and Digestive and Kidney Diseases, Bethesda, Maryland 20892,¹ and Department of Microbiology, Uniformed Services University of the Health Sciences, Bethesda, Maryland 20814²

Received 8 February 1988/Accepted 8 April 1988

The heat-labile enterotoxins of *Vibrio cholerae* and *Escherichia coli* are related in structure and function. They are oligomers consisting of A and B polypeptide subunits. They bind to gangliosides, and they activate adenylate cyclase. The toxins form two antigenically distinct groups; members of each group cross-react but are not necessarily identical. Serogroup I includes cholera toxin (CT) and type I heat-labile enterotoxin (LT-I) of *E. coli*. LTh-I and LTp-I are antigenic variants of LT-I produced by strains of *E. coli* from humans and pigs, respectively. Serogroup II contains the type II heat-labile enterotoxin (LT-II) of *E. coli*. Two antigenic variants designated LT-IIa and LT-IIb have been described. The binding of CT, LTh-I, LT-IIa, and LT-IIb to gangliosides was analyzed by immunostaining thin-layer chromatograms and by solid-phase radioimmunoassay. The four toxins have different glycolipid-binding specificities. LTh-I and CT bind strongly to ganglioside GM1 and less strongly to ganglioside GD1b. However, LTh-I, unlike CT, also binds weakly to GM2 and asialo GM1. LTh-I, like CT, probably binds to the terminal sugar sequence Gal β 1-3GalNAc β 1-4(NeuAc α 2-3)Gal . . . , where GalNAc is *N*-acetylgalactosamine and NeuAc is *N*-acetylneuraminic acid. LT-IIa probably binds to the same sugar sequence to which CT and LTh-I bind, with the additional contribution to binding of a second NeuAc as in GD1b and GD2. Also, LT-IIa must bind the Gal β 1-3GalNAc . . . sequence in such a way that its binding is relatively unaffected by attachment of NeuAc to the terminal galactose residue as in GD1a, GT1b, and GQ1b. LT-IIb probably binds to the terminal sugar sequence NeuAc α 2-3Gal β 1-4GalNAc . . . , as it binds to gangliosides GD1a and GT1b but not to GM1.

The heat-labile enterotoxins of *Vibrio cholerae* and *Escherichia coli* are protein toxins that are related in structure and action (7, 13, 17, 27). They are all oligomers composed of polypeptide subunits designated A and B. Their biologic activities are determined by the binding specificities of the B subunits and the enzymatic activities of the A subunits. The B subunits bind to the sugar chains of gangliosides on the surface of susceptible cells. The A subunit, after proteolytic activation, stimulates adenylate cyclase by catalyzing the NAD-dependent adenosine diphosphate ribosylation of Gs regulatory protein in the adenylate cyclase complex.

The enterotoxins of *V. cholerae* and *E. coli* form two groups based on reactivity with antisera. Serogroup I includes cholera toxin (CT) and the classical type I heat-labile enterotoxin (LT-I) of *E. coli* (29). All toxins in serogroup I are neutralized by antisera prepared against CT. Classical enterotoxigenic *E. coli* strains of human and porcine origin produce variants of LT-I that belong to two different antigenic subgroups, designated LTh-I and LTp-I, respectively (20). Additional analysis of antigenic variation affecting specific epitopes on the B subunits of CT and LT-I produced by individual bacterial strains was also reported recently (8). The enterotoxins in serogroup I are virulence factors for the bacteria that produce them and cause secretory diarrhea in infected hosts by activating adenylate cyclase in mucosal cells of the small intestine (27). The prototype toxin in serogroup II is *E. coli* type II heat-labile enterotoxin (LT-II) (17, 29, 30), initially called LT-like toxin (10). Strains of *E.*

coli that produce LT-II have been isolated from water buffalo, cattle, and humans as well as from food (10, 12). Antigenic variants designated LT-IIa and LT-IIb have been identified and purified (13, 17), and the structural genes for LT-IIa have been cloned and sequenced (29, 30). Toxins in serogroup II are not neutralized by antiserum against CT but are neutralized by antiserum against the prototype LT-IIa (13, 17, 29). LT-IIa and LT-IIb, like CT and LT-I, induce rounding of cultured Y1 adrenal cells (17, 29) and activate adenylate cyclase in cell cultures (3, 17; P. Chang, J. Moss, E. Twiddy, and R. Holmes, unpublished data). Purified LT-IIa does not elicit a secretory response in adult rabbit ligated ileal segments (17), and the activity of purified LT-IIb has not yet been tested in animals (13). The role of LT-IIa or LT-IIb in the pathogenesis of infectious diseases caused by *E. coli* is not established.

CT and LT-I bind to the ganglioside GM1 (for abbreviations, see below), which is a cell surface receptor for the enterotoxins of serogroup I (27). In addition, LT-I binds to another cell surface component, probably a glycoprotein, to which CT does not bind (11, 18, 19). LT-IIa and LT-IIb are much less susceptible to inhibition of their biologic activities by GM1 than are LT-I and CT (13, 17). This paper compares the glycolipid-binding specificities of purified CT, LTh-I, LT-IIa, and LT-IIb, which are representative members of enterotoxin serogroups I and II. Based on the results, the probable sugar sequence bound by each toxin was deduced. (This work was presented in part at the meeting of the American Society of Biological Chemistry, June 1987, Philadelphia, Pa.)

* Corresponding author.

MATERIALS AND METHODS

Abbreviations. Glc, Glucose; GlcNAc, *N*-acetylglucosamine; Gal, galactose; GalNAc, *N*-acetylgalactosamine; NeuAc, *N*-acetylneuraminic acid; GM1, Gal β 1-3GalNAc β 1-4(NeuAc α 2-3)Gal β 1-4Glc β 1-1ceramide; asialo GM1, Gal β 1-3GalNAc β 1-4Gal β 1-4Glc β 1-1ceramide; GM2, GalNAc β 1-4(NeuAc α 2-3)Gal β 1-4Glc β 1-1ceramide; GM3, NeuAc α 2-3Gal β 1-4Glc β 1-1ceramide; GD1a, NeuAc α 2-3Gal β 1-3GalNAc β 1-4(NeuAc α 2-3)Gal β 1-4Glc β 1-1ceramide; GD1b, Gal β 1-3GalNAc β 1-4(NeuAc α 2-8NeuAc α 2-3)Gal β 1-4Glc β 1-1ceramide; GD2, GalNAc β 1-4(NeuAc α 2-8NeuAc α 2-3)Gal β 1-4Glc β 1-1ceramide; GD3, NeuAc α 2-8NeuAc α 2-3Gal β 1-4Glc β 1-1ceramide; GT1b, NeuAc α 2-3Gal β 1-3GalNAc β 1-4(NeuAc α 2-8NeuAc α 2-3)Gal β 1-4Glc β 1-1ceramide; GT3, NeuAc α 2-8NeuAc α 2-3Gal β 1-4Glc β 1-1ceramide; GQ1b, NeuAc α 2-8NeuAc α 2-3Gal β 1-3GalNAc β 1-4(NeuAc α 2-8NeuAc α 2-3)Gal β 1-4Glc β 1-1ceramide; PBS, phosphate-buffered-saline.

Toxins, antibodies, and gangliosides. LTh-I was purified from *E. coli* HE22(pTD2) (16). Plasmid pTD2 encodes LTh-I and was derived from *E. coli* Throop D (28). LT-IIa was purified from *E. coli* HB101(pCP3727), which contains the LT-II structural genes from *E. coli* SA53 subcloned into the plasmid vector pBR322 (17). LT-IIb was produced from *E. coli* 41, which belongs to serotype O8:H21 and was isolated in Sao Paulo, Brazil, from cooked beef (13). CT was purchased from List Biological Laboratories, Inc., Campbell, Calif.

Monoclonal antibodies that bind either CT, LTh-I, LT-IIa, or LT-IIb were produced from hybridomas obtained by fusing spleen cells from BALB/c mice immunized with purified toxin with Sp2/0-Ag14 murine plasmacytoma cells and cloning them repeatedly by limiting dilution as described elsewhere (15). Hybridoma culture supernatants were the source of monoclonal antibodies. All of the antibodies used for the current studies were neutralizing antibodies of the immunoglobulin G1 (IgG1) subclass. Monoclonal antibody 32D3 is specific for the B subunit of CT; it cross-reacts with LTh-I and LTp-I in binding assays but neutralizes only CT (1, 15). Monoclonal antibody 12G5 is specific for the B subunit of LTh-I; it cross-reacts with LTp-I but not with CT in binding and neutralization tests (1). Monoclonal antibody 5C5 was prepared against LT-IIa toxin; it binds to LT-IIa and LT-IIb but only neutralizes LT-IIa.

Affinity-purified goat anti-mouse IgG was purchased from Kirkegaard and Perry Laboratories, Inc., Gaithersburg, Md., and iodinated with Na¹²⁵I by Iodogen treatment (9) to a specific activity of 30 to 40 μ Ci/ μ g.

Standard gangliosides were isolated and purified by conventional methods (24). Asialo GM1 was kindly supplied by Pam Fredman, University of Goteborg, Goteborg, Sweden.

Detection of toxin binding to glycolipids directly on thin-layer chromatograms. Glycolipids that bind toxins were detected on thin-layer chromatograms as reported previously (26) with the following modifications. Total lipid extracts from fetal calf brain and mouse Y1 adrenal cells as well as purified gangliosides were chromatographed on aluminum-backed high-performance thin-layer chromatography plates (Silica Gel 60; E. Merck, Darmstadt, Federal Republic of Germany) in chloroform-methanol-0.25% KCl in H₂O (5:4:1). The dried chromatogram was immersed for 1 min in 0.1% polyisobutylmethacrylate (Polysciences, Inc., Warrington, Pa.) in hexane. After drying in air, the chromatogram was sprayed with buffer A (0.05 M Tris hydrochloride-0.15 M NaCl [pH 7.8] with 1% bovine serum albumin and

0.1% sodium azide) and immediately soaked in the same buffer until all of the silica gel was wet (15 min). The plate was then removed and overlaid with the appropriate toxin in buffer A (44 ng of toxin per ml, 60 μ l/cm²) and incubated for 1 h at room temperature. The chromatogram was washed by dipping in four successive changes in cold PBS (0.01 M sodium phosphate, 0.15 M NaCl, pH 7.2) and then overlaid with the appropriate monoclonal antibody diluted in buffer A (5 μ g/ml) and incubated for 1 h at room temperature. The plate was washed again in PBS as described before and then overlaid with buffer A containing 2×10^6 cpm of ¹²⁵I-labeled goat anti-mouse IgG (40 μ Ci/ μ g) per ml. After 1 h at room temperature, the plate was washed four times in cold PBS, dried, and exposed to XAR-5 X-ray film (Eastman Kodak, Rochester, N.Y.).

Solid-phase binding assay. The binding of toxin to gangliosides was measured by a modification of a solid-phase radioimmunoassay (2). Gangliosides were serially diluted in methanol and added to the wells of a round-bottom 96-well polyvinylchloride microtiter plate (Dynatech, Alexandria, Va.), and the solutions were dried under reduced pressure. The wells were then filled with buffer A. After 30 min the wells were emptied, and to each was added 50 μ l of toxin diluted with buffer A (44 ng/ml). The plate was then covered with Parafilm, incubated for 1 h at room temperature, and washed once with buffer A, and then 50 μ l of monoclonal antibodies diluted in buffer A (5 μ g/ml) was added to each well. The plate was incubated again for 1 h at room temperature and washed once with buffer A, and then about 10⁵ cpm of ¹²⁵I-labeled goat anti-mouse IgG in 50 μ l of buffer A was added to each well. After 1 h at room temperature, the wells were washed six times with cold PBS, cut from the plate, and analyzed for ¹²⁵I in a gamma scintillation spectrometer.

Neuraminidase treatment of gangliosides. Gangliosides serially diluted in methanol were added to the wells of a microtiter plate, and the solutions were dried under vacuum. The wells were then filled with buffer A. After 1 h the wells were emptied and to each was added 0.02 U of *Clostridium perfringens* neuraminidase (type X; Sigma Chemical Co., St. Louis, Mo.) in 100 μ l of 0.05 M sodium acetate (pH 5.5) containing 0.15 M NaCl and 0.009 M CaCl₂. Control wells received only the acetate buffer. After 16 h at 37°C, the plate was assayed for toxin binding as described above.

RESULTS

Binding of heat-labile enterotoxins to glycolipids of mouse Y1 adrenal cells and fetal calf brain. The biological activity of CT or LT can be conveniently measured by a change in morphology or by stimulation of adenylate cyclase in cultured mouse Y1 adrenal cells (6). In the present study the toxin-binding glycolipids of Y1 cells and of fetal calf brain were detected by direct binding of toxins to thin-layer chromatograms of total lipid extracts, followed by immunostaining. CT and LTh-1 bound to the same glycolipids, presumably GM1 and GD1b (19, 21) (Fig. 1B and C). They bound to glycolipids with the mobility of GM1 and GD1b in extracts of fetal calf brain (Fig. 1B and C, lanes 1) and to glycolipids with the mobility of GM1 in extracts of Y1 cells (Fig. 1B and C, lanes 2). The binding patterns obtained with toxins LT-IIa and LT-IIb (Fig. 1D and E) were different from those obtained with CT and LTh-I. LT-IIa bound to several glycolipids in addition to those with the mobility of GM1 and GD1b (Fig. 1D). In contrast, LT-IIb did not bind to glycolipids with the mobility of GM1 and GD1b but did bind to

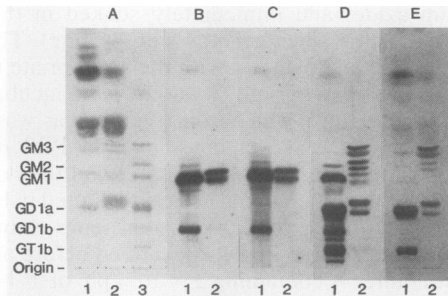

FIG. 1. Binding of toxins to gangliosides from fetal calf brain and mouse Y1 adrenal cells after thin-layer chromatography. Gangliosides were visualized (A) with resorcinol reagent or by immunostaining with (B) CT, (C) LTh-1, (D) LT-IIa, or (E) LT-IIb. (A through E) Lanes 1, total gangliosides from 1.0, 0.4, 0.4, 1, and 1 mg (wet weight) of fetal calf brain, respectively; lanes 2, total gangliosides from 4, 1.6, 1.6, 4, and 4 mg (wet weight) of mouse Y1 adrenal cells, respectively. (A) Lane 3, 1 μ g each of standard gangliosides identified at the left margin. Double bands, such as those detected in lanes 2 of panels B and C, are due to glycolipids with the same carbohydrate structures but differences in their ceramides (22).

several of the glycolipids that bound LT-IIa (Fig. 1E). The major fast-migrating glycolipid detected by resorcinol in extracts of fetal calf brain (Fig. 1A, lane 1) is sulfatide. Sulfatide nonspecifically binds 125 I-antibody in the absence of the toxins (Fig. 1B through E, lanes 1, and data not shown).

Binding of toxins to purified gangliosides. The binding of CT, LTh-I, LT-IIa, and LT-IIb to thin-layer chromatograms of purified gangliosides is shown in Fig. 2. CT and LTh-I bound to GM1 and GD1b (Fig. 2A and B, lanes 2 and 3). LT-IIa bound GM2, GM1, GD1a, GD2, GD1b, GT1b, and GQ1b (Fig. 2C, lanes 2 through 8) and to high concentrations of GM3 (data not shown). LT-IIb bound to GM3, GM2, GD1a, and GT1b (Fig. 2D, lanes 2 through 5).

Relative binding affinities of the toxins to purified gangliosides. The relative binding affinities of the toxins to the various gangliosides were measured by solid-phase radioimmunoassays. CT and LTh-I bound best to GM1 followed by GD1b (Fig. 3A and B). Weak binding of LTh-I to GM2 was also demonstrated in this assay system. LT-IIa bound best to GD1b, followed by GD1a, GT1b, GQ1b, GM1, GD2, GM2,

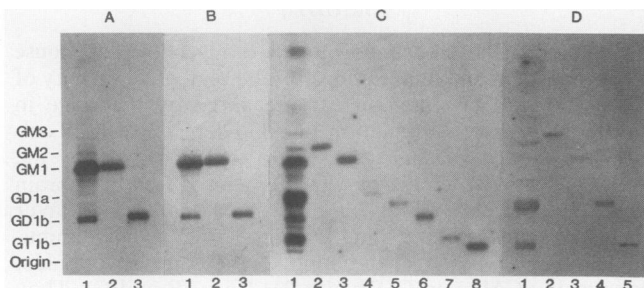

FIG. 2. Binding of toxins to purified gangliosides after thin-layer chromatography. Gangliosides were visualized by immunostaining with (A) CT, (B) LTh-I, (C) LT-IIa, or (D) LT-IIb. (A and B) Lanes 1, total gangliosides from 0.4 mg (wet weight) of fetal calf brain; lanes 2, 20 ng of GM1; lanes 3, 30 ng of GD1b. (C) Lane 1, total gangliosides from 1 mg (wet weight) of fetal calf brain; lanes 2 through 8, 30 ng of GM2, GM1, GD1a, GD2, GD1b, GT1b, and GQ1b, respectively. (D) Lane 1, total gangliosides from 1 mg (wet weight) of fetal calf brain; lanes 2 through 5, 100 ng of GM3, GM2, GD1a, and GT1b, respectively.

and GM3 (Fig. 3C), and did not bind to GD3 or GT3. LT-IIb bound best to GD1a, followed by GT1b (Fig. 3D). It bound weakly to GM3 and not at all to GM1, GM2, GD1b, GD2, GD3, GT3, or GQ1b. The amounts of ganglioside needed to detect binding of toxin in this solid-phase radioimmunoassay system were smallest with CT and LTh-1, intermediate with LT-IIa, and greatest with LT-IIb.

Effect of neuraminidase on binding of the toxins to gangliosides. GM1 was resistant to hydrolysis by *C. perfringens* neuraminidase. CT, LTh-I, and LT-IIa, all of which bound to GM1, also bound to neuraminidase-treated glycolipid extracts as expected (data not shown). In contrast, LT-IIb did not bind to GM1, and its binding to lipid extracts was almost abolished by treatment of the lipids with neuraminidase (Fig. 4).

Binding of LTh-I to asialo GM1. Whereas CT, LTh-I, and LT-IIa all bound to GM1, only LTh-I bound to asialo GM1 in solid-phase radioimmunoassays, albeit weakly (Fig. 5). The weak binding of LTh-I to asialo GM1 and the failure of CT to bind to asialo GM1 were confirmed by immunostaining of thin-layer chromatograms (Fig. 6).

DISCUSSION

The structures of gangliosides that bound each of the toxins relatively well (Fig. 1 to 3) are diagrammed in Fig. 7 using the system of Fredman (P. Fredman, Ph.D thesis, University of Goteborg, Goteborg, Sweden, 1979). By comparing these structures with gangliosides that failed to bind the toxins, the sugar sequences required for tight binding were deduced.

CT and LTh-I probably bind to the terminal sugar sequence Gal β 1-3GalNAc β 1-4(NeuAc α 2-3)Gal. . . , as they bind best to GM1 and GD1b (Fig. 3A and B). LTh-I, unlike CT, binds weakly to GM2 as well as to asialo GM1 (Fig. 5 and 6). This difference may account for the fact that LT-I, but not CT, binds to glycoproteins from rabbit and human intestine (11, 18, 19) and to agarose (7). The minimum requirement for binding of LTh-I appears to be the terminal galactose residue, and D-galactose competes with LTh-I for binding to agarose.

LT-IIa probably binds to the same sugar sequence that CT and LTh-I bind to, with the additional contribution to binding of a second NeuAc as in GD1b and GD2. LT-IIa binds better to GD1b than to GM1 and better to GD2 than to GM2 (Fig. 3C). Also, LT-IIa must bind the Gal β 1-3GalNAc . . . sequence in such a way that its binding is relatively unaffected by attachment of NeuAc to the terminal galactose residue as in GD1a, GT1b, and GQ1b. LT-IIa also binds weakly to GM2 and GM3.

LT-IIb probably binds to the terminal sugar sequence NeuAc α 2-3Gal β 1-3GalNAc. . . , as it binds to GD1a and GT1b but not to GM1 (Fig. 3D). LT-IIb also binds weakly to GM3. Because LT-IIb does not bind to GM1 it differs from CT, LTh-I, and LT-IIa in that its binding to gangliosides is abolished by treatment of the gangliosides with neuraminidase (Fig. 4).

Previous studies demonstrated that binding to GM1 is mediated by the B subunits of CT and LTh-I (7) and established that the functionally similar B polypeptides of these toxins are 82% homologous in their amino acid sequences (33). The structural genes for LT-IIa have also been cloned (29), and their nucleotide sequences have been determined (30). The A1 fragments of LT-IIa and LTh-I have similar ADP-ribosyltransferase activities and are 62% homologous in amino acid sequence, providing a strong genetic

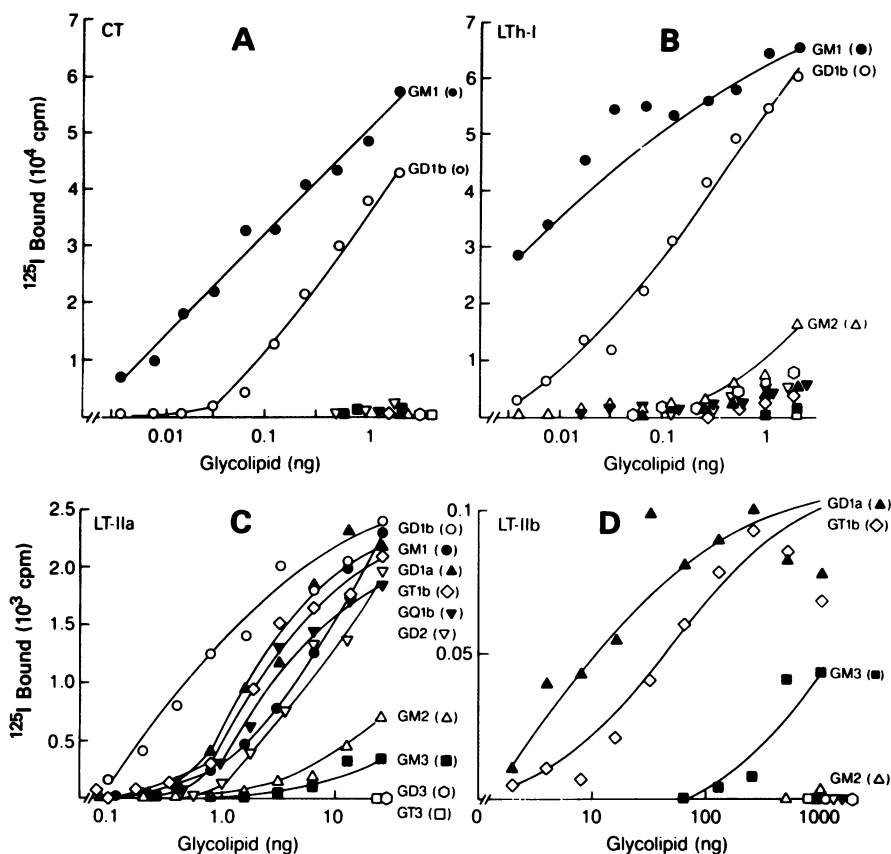

FIG. 3. Relative affinity of toxin binding to purified gangliosides. The binding of toxins was measured by solid-phase radioimmunoassays. (A) CT; (B) LTh-I; (C) LT-IIa; (D) LT-IIb. Symbols: Binding to GM1 (●), GM2 (△), GM3 (■), GD1a (▲), GD1b (○), GD2 (▽), GD3 (◇), GT1b (◇), GT3 (□), and GQ1b (▼).

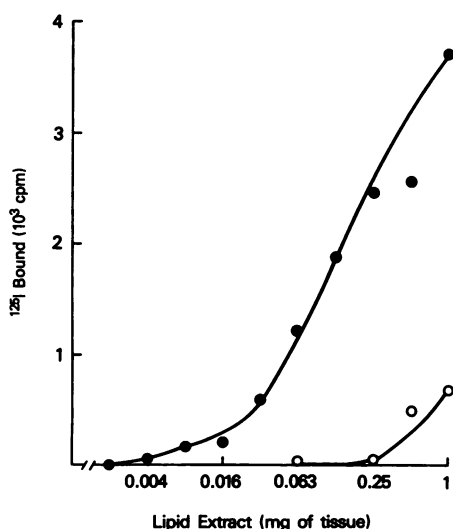

FIG. 4. Effect of neuraminidase on the binding of toxin LT-IIb to total gangliosides from mouse Y1 adrenal cells. The binding of LT-IIb was measured by solid-phase radioimmunoassays using untreated gangliosides (●) and gangliosides treated with neuraminidase (○).

basis for inclusion of the LT-II serogroup in the *V. cholerae-E. coli* family of heat-labile enterotoxins. In contrast, the B subunits of LT-IIa and LTh-I have different ganglioside-binding specificities and no significant amino acid sequence homology, although they are quite similar in size, secondary structure, and hydrophobicity. Additional studies are needed to determine the location and conformation of the ganglioside-binding domains of these toxins and to establish

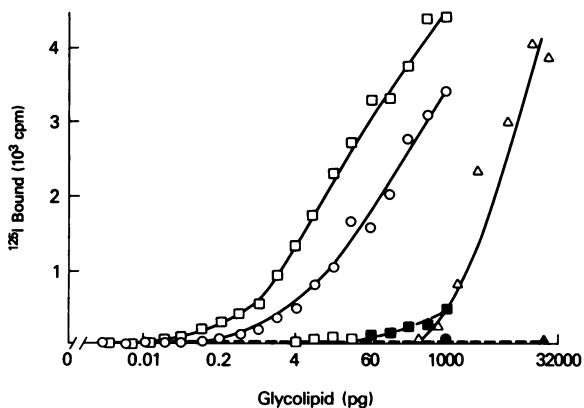

FIG. 5. Binding of toxins CT (●, ○), LTh-I (■, □), and LT-IIa (▲, △) to GM1 (open symbols) and asialo GM1 (closed symbols), measured by solid-phase radioimmunoassays.

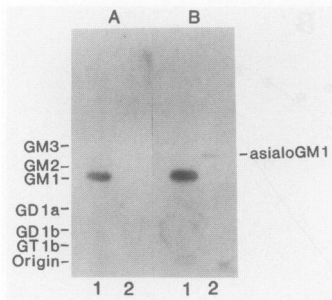

FIG. 6. Binding of toxin LTh-I to asialo GM1 after thin-layer chromatography. Gangliosides were visualized by immunostaining with (A) CT and (B) LTh-I. Lane 1, GM1 (30 ng); lane 2, asialo GM1 (100 ng).

whether differences in binding specificities are responsible for differences in their biologic activities.

Previous studies demonstrated that GM1 is a functional receptor for CT and LT-I (reviewed in reference 7) and indicated that LT-I also binds to a second class of receptors that is not recognized by CT (11, 18, 19). In the present study, the carbohydrate-binding specificities of LT-IIa and LT-IIb were deduced and compared with those of CT and LTh-I, but the cell surface receptors for LT-IIa and LT-IIb were not identified or characterized. The weaker affinity of LT-IIa for GM1 than for several other gangliosides found in Y1 adrenal cells (Fig. 1 and 3) was consistent with its low potency as an inhibitor of LT-IIa (17), and the failure of LT-IIb to bind GM1 (Fig. 1 and 3) correlated with its failure to inhibit LT-IIb (13). Addition of GD1a to Y1 adrenal cell cultures under conditions similar to those used with GM1 completely inhibited the toxicity of LT-IIa but failed to block the toxicity of LT-IIb (data not shown). These findings provide strong support for the hypothesis that the cell surface receptor of LT-IIa contains a sugar sequence related to the oligosaccharide moieties of the LT-IIa-binding gangliosides shown in Fig. 7. The failure of GD1a to block the toxicity of LT-IIb under similar conditions might reflect the

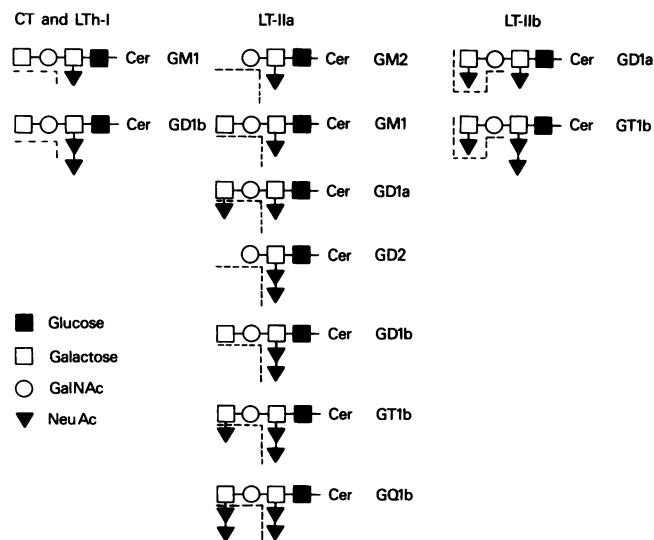

FIG. 7. Structure of gangliosides that bind toxins CT, LTh-I, LT-IIa, and LT-IIb. The probable sugar sequence involved in binding each toxin is defined by the dotted line.

apparently lower affinity of GD1a for LT-IIb than for LT-IIa (Fig. 3), or, alternatively, the receptor might contain a different oligosaccharide to which LT-IIb binds with higher affinity than it does to GD1a.

In addition to CT, LT-I, and LT-II, other bacterial toxins that bind to glycolipids include *Clostridium botulinum* neurotoxin type A, which binds to GD1a, GD1b, and GQ1b (31); tetanus toxin, which binds to GD1b and GT1b (32); *Clostridium difficile* toxin A, which binds to Gal α 1-3Gal β 1-4GlcNAc-terminated glycolipids (4); *Shigella dysenteriae* type 1 toxin, which binds to Gal α 1-4Gal-containing glycolipids (25); and *Bacillus thuringiensis* toxin, which binds to Gal α 1-3GalNAc β 1-4-GlcNAc- β 1-3Man β 1-4Glc in an insect glycolipid (5). Glycolipids are structurally complex, ubiquitous components of plasma membranes. As the distribution of specific glycolipids differs among various cell types, tissues, and animal species (14), it is not surprising that toxins that use glycolipids as receptors should vary in their activities towards different cells. The host range of viruses and bacteria that use glycolipids as receptors (23) is also determined in part by the occurrence of specific glycolipids.

ACKNOWLEDGMENT

This work was supported in part by Public Health Service grant 5 R22 AI14107 from the National Institutes of Health.

LITERATURE CITED

- Belisle, B. W., E. M. Twiddy, and R. K. Holmes. 1984. Monoclonal antibodies with an expanded repertoire of specificities and potent neutralizing activity for *Escherichia coli* heat-labile enterotoxin. *Infect. Immun.* **46**:759-764.
- Brockhaus, M., J. L. Magnani, M. Blaszczyk, Z. Stepkowski, H. Koprowski, K.-A. Karlsson, G. Larson, and V. Ginsburg. 1981. Monoclonal antibody directed against the human Le^b blood group antigen. *J. Biol. Chem.* **256**:13223-13225.
- Chang, P. P., J. Moss, E. M. Twiddy, and R. K. Holmes. 1987. Type II heat-labile enterotoxin of *Escherichia coli* activates adenylate cyclase in human fibroblasts by ADP ribosylation. *Infect. Immun.* **55**:1854-1858.
- Clark, G. F., C. H. Krivan, T. D. Wilkins, and D. F. Smith. 1987. Toxin A from *Clostridium difficile* binds to rabbit erythrocyte glycolipids with terminal Gal α 1-3Gal β 1-4GlcNAc sequences. *Arch. Biochem. Biophys.* **257**:217-229.
- Dennis, R. D., H. Wiegandt, D. Haustein, B. H. Knowles, and D. J. Ellar. 1986. Thin layer chromatography overlay technique in the analysis of the binding of the solubilized protoxin of *Bacillus thuringiensis* var. *kurstaki* to an insect glycosphingolipid of known structure. *Biomed. Chrom.* **1**:31-37.
- Donta, S. T., H. W. Moon, and S. L. Whipp. 1974. Detection of heat-labile enterotoxin with the use of adrenal cells in tissue culture. *Science* **183**:334-336.
- Eidels, L., R. L. Proia, and D. A. Hart. 1983. Membrane receptors for bacterial toxins. *Microbiol. Rev.* **47**:596-620.
- Finkelstein, R. A., M. F. Burks, A. Zupan, W. S. Dallas, C. O. Jacob, and D. S. Ludwig. 1987. Epitopes of the cholera family of enterotoxins. *Rev. Infect. Dis.* **9**:544-561.
- Fraker, P. J., and J. C. Speck, Jr. 1978. Protein and cell membrane iodinations with a sparingly soluble chloroamide, 1, 3,4,6-tetrachloro-3a,6a-diphenylglycoluril. *Biochem. Biophys. Res. Commun.* **80**:849-857.
- Green, B. A., R. J. Neill, W. T. Ruyechan, and R. K. Holmes. 1983. Evidence that a new enterotoxin of *Escherichia coli* which activates adenylate cyclase in eucaryotic target cells is not plasmid mediated. *Infect. Immun.* **41**:383-390.
- Griffiths, S. L., R. A. Finkelstein, and R. R. Critchley. 1986. Characterization of the receptor for cholera toxin and *Escherichia coli* heat-labile toxin in rabbit intestinal brush borders. *Biochim. J.* **238**:313-322.
- Guth, B. E. C., C. L. Pickett, E. M. Twiddy, R. K. Holmes, T. A. T. Gomes, A. A. M. Lima, R. L. Guerrant, B. D. G. M.

- Franco, and L. Trabulsi. 1986. Production of type II heat-labile enterotoxin by *Escherichia coli* isolated from food and human feces. *Infect. Immun.* **54**:587-589.
13. Guth, B. E. C., E. M. Twiddy, L. R. Trabulsi, and R. K. Holmes. 1986. Variation in chemical properties and antigenic determinants among type II heat-labile enterotoxins of *Escherichia coli*. *Infect. Immun.* **54**:529-536.
 14. Hakomori, S., and R. Kannagi. 1983. Glycolipids as tumor-associated and differentiation markers. *J. Natl. Cancer Inst.* **71**:231-252.
 15. Holmes, R. K., and E. M. Twiddy. 1983. Characterization of monoclonal antibodies that react with unique and cross-reacting determinants of cholera enterotoxin and its subunits. *Infect. Immun.* **42**:914-923.
 16. Holmes, R. K., E. M. Twiddy, and M. G. Bramucci. 1983. Antigenic heterogeneity among heat-labile enterotoxins from *Escherichia coli*, p. 293-300. *In* S. Kuwahara and N. F. Pierce (ed.), *Advances in research on cholera and related diarrheas*. KTK Scientific Publishers, Tokyo.
 17. Holmes, R. K., E. M. Twiddy, and C. L. Pickett. 1986. Purification and characterization of type II heat-labile enterotoxin of *Escherichia coli*. *Infect. Immun.* **53**:464-473.
 18. Holmgren, J., P. Fredman, M. Lindblad, A.-M. Svennerholm, and L. Svennerholm. 1982. Rabbit intestinal glycoprotein receptor for *Escherichia coli* heat-labile enterotoxin lacking affinity for cholera toxin. *Infect. Immun.* **38**:424-433.
 19. Holmgren, J., M. Lindblad, P. Fredman, L. Svennerholm, and H. Myrvold. 1985. Comparison of receptors for cholera and *Escherichia coli* enterotoxins in human intestine. *Gastroenterology* **89**:27-35.
 20. Honda, T., T. Tsuji, Y. Takeda, and T. Miwatani. 1981. Immunological nonidentity of heat-labile enterotoxins from human and porcine enterotoxigenic *Escherichia coli*. *Infect. Immun.* **34**:337-340.
 21. Iwamori, M., J. Shimomura, and N. Nagai. 1985. Specific binding of cholera toxin to rat erythrocytes revealed by analysis with a fluorescence-activated cell sorter. *J. Biochem.* **97**:729-735.
 22. Kananagi, R., E. Nudelman, and S.-I. Hakomori. 1982. Possible role of ceramide in defining structure and function of membrane glycolipids. *Proc. Natl. Acad. Sci. USA* **79**:3470-3474.
 23. Karlsson, K. A., and N. Stromberg. 1987. Overlay and solid-phase analysis of glycolipid receptors for bacteria and viruses. *Methods Enzymol.* **138**:220-231.
 24. Ledeen, R. W., and R. K. Yu. 1982. Gangliosides: structure, isolation and analysis. *Methods Enzymol.* **83**:139-191.
 25. Lindberg, A. A., J. E. Brown, N. Stromberg, M. Westling-Ryd, J. E. Schultz, and K. A. Karlsson. Identification of the carbohydrate receptor for Shiga toxin produced by *Shigella dysenteriae* type 1. *J. Biol. Chem.* **262**:1779-1785.
 26. Magnani, J. L., D. F. Smith, and V. Ginsburg. 1980. Detection of gangliosides that bind cholera toxin: direct binding of ¹²⁵I-labeled toxin to thin-layer chromatograms. *Anal. Biochem.* **108**:399-402.
 27. Middlebrook, J. L., and R. B. Dorland. 1984. Bacterial toxins: cellular mechanisms of action. *Microbiol. Rev.* **48**:199-221.
 28. Neill, R. J., E. M. Twiddy, and R. K. Holmes. 1983. Synthesis of plasmid-coded heat-labile enterotoxin in wild-type and hyper-toxinogenic strains of *Escherichia coli* and in other genera of *Enterobacteriaceae*. *Infect. Immun.* **41**:1056-1061.
 29. Pickett, C. L., E. M. Twiddy, B. W. Belisle, and R. K. Holmes. 1986. Cloning of genes that encode a new heat-labile enterotoxin of *Escherichia coli*. *J. Bacteriol.* **165**:348-352.
 30. Pickett, C. L., D. L. Weinstein, and R. K. Holmes. 1987. Genetics of type IIa heat-labile enterotoxin of *Escherichia coli*: operon fusions, nucleotide sequence, and hybridization studies. *J. Bacteriol.* **169**:5180-5187.
 31. Takamizawa, K., M. Iwamori, S. Kozaki, G. Sakaguchi, R. Tanaka, H. Takayama, and Y. Nagai. 1986. TLC immunostaining characterization of *Clostridium botulinum* type A neurotoxin binding to gangliosides and free fatty acids. *FEBS Lett.* **201**:229-232.
 32. van Heyningen, W. E. 1974. Gangliosides as membrane receptors for tetanus toxin, cholera toxin and serotonin. *Nature (London)* **249**:415-417.
 33. Yamamoto, T., T. Nakazawa, T. Miyata, A. Kaji, and T. Yokota. 1984. Evolution and structure of two ADP-ribosylation enterotoxins, *Escherichia coli* heat-labile toxin and cholera toxin. *FEBS Lett.* **169**:241-246.