

# Effect of Lengthening Lymphocyte Function-Associated Antigen 3 on Adhesion to CD2

Po-Ying Chan and Timothy A. Springer

Harvard Medical School and Center for Blood Research, 800 Huntington Avenue, Boston, Massachusetts 02115

Submitted to Cell Regulation August 30, 1991; Accepted November 20, 1991

The effect of lengthening the distance in an adhesion molecule between the receptor binding site and the membrane anchor was studied by inserting four Ig-like domains into the two Ig domain lymphocyte function-associated antigen 3 (LFA-3) molecule. The extended molecule expressed in Chinese hamster ovary (CHO) cells bound to CD2 on T lymphocytes 4- to 20-fold more efficiently than the wild-type molecule at 4°C. Treatment of the CHO clones with neuraminidase to remove sialic acid, or with deoxymannojirimycin to reduce the bulk of N-linked glycosylation, showed that adhesion to both the wild-type and the chimeric LFA-3 molecules was under the influence of cell-cell repulsive forces to a similar extent and that these treatments had less effect than lengthening LFA-3. At higher temperatures, such as 22 and 37°C, the efficiency of binding to the wild-type LFA-3 increased to levels comparable with binding to extended LFA-3. Our results suggest that more distal locations of the adhesive binding site from the cell membrane anchor increase the efficiency of cell-cell adhesion by enhancing the frequency of receptor encounter with ligand and that more proximal locations of the adhesive binding site can provide efficient cell-cell adhesion at physiological temperatures.

## INTRODUCTION

Cell-cell adhesion is important in biological processes, such as cell development, morphogenesis, cell migration, and immune responses. Ligation of specific adhesion receptors and counter-receptors on the surface of apposing cells allows stable juxtaposition of the cell pair and interaction of other cell-surface receptors in the cell contact area. Such adhesion events often precede signal transduction that leads to tissue-specific biological responses (reviewed in Springer, 1990b).

The development of stable cell-cell adhesion is influenced by a number of biophysical and biochemical properties of the apposing cell surfaces. These properties govern the feasibility of the ligation of a sufficient number of adhesion receptors and counter-receptors in the cell-cell contact area. The more ligation bonds formed and the stronger the bonds, the more stable the cell-cell adhesion becomes. The abundance of adhesion receptors on the cell surface, repulsion of cells by surface charge, and receptor mobility are characterized factors that affect the efficiency of cell adhesion (Springer, 1990b; Chan *et al.*, 1991). However, many other factors have yet to be studied. One potentially important factor is the distance in an adhesion receptor between the

binding site and the anchor in the cell membrane. The binding site is most commonly in the membrane-distal domain, as shown for the Ig family members CD2, CD4, and ICAM-1 (Springer, 1990b) and for the selectins (Walz *et al.*, 1990). Within each family, molecules differ considerably in the number of domains interposed between the binding domain and the membrane (Springer, 1990b), yet the significance of this variation is unknown. Lengthening the distance between the binding site and the anchor could facilitate accessibility of the binding site, allowing it to extend further above the cell membrane and mediate cell binding at a greater intermembrane distance between two cells, lessening repulsion between the glycocalyxes of the two cells. Lengthening would also allow extension in the direction parallel to the membrane, allowing interaction between molecules whose anchors are not perfectly aligned in the direction perpendicular to the membranes of the two cells.

A well-characterized system for the study of adhesion is the interaction between the two Ig family members, CD2 and lymphocyte function-associated antigen 3 (LFA-3) (Springer, 1990b). CD2 is expressed on human T lymphocytes, whereas LFA-3 is broadly distributed on human cells (Sanchez-Madrid *et al.*, 1982; Krensky *et al.*, 1983). CD2 binding to LFA-3 is one of the adhe-

sion mechanisms important in T-lymphocyte recognition of antigen-presenting and target cells (reviewed in Springer, 1990b) and is involved in the interaction of thymocytes with thymic epithelial cells (Denning *et al.*, 1987; Yang *et al.*, 1988). CD2 is also responsible for the long-puzzling phenomenon of human T-lymphocyte rosetting with sheep erythrocytes, which is mediated by binding to the sheep homologue of LFA-3. Peripheral blood T lymphocytes rosette with sheep but not human erythrocytes, because the density of LFA-3 on human erythrocytes is fourfold lower than in the sheep (Selvaraj *et al.*, 1987a). Quantitative variation in density of LFA-3 on human erythrocytes, in deficiency diseases or after incorporation of exogenous LFA-3, is well correlated with rosetting efficiency (Selvaraj *et al.*, 1987b). Rosetting with erythrocytes of both species is enhanced or unmasked by neutralizing the net negative surface charge of cells by covalent modification or by enzymatic removal of sialic acid (Bentwich *et al.*, 1973; Plunkett *et al.*, 1987). Two isoforms of LFA-3 are derived by alternative mRNA splicing; one has a glycosylphosphatidylinositol anchor and the other has a classical polypeptide anchor with a hydrophobic transmembrane domain and a short cytoplasmic tail (Dustin *et al.*, 1987b; Seed, 1987; Wallner *et al.*, 1987). Both are fully active in mediating CD2-dependent adhesion and in promoting T-cell function (Hollander *et al.*, 1988; Dustin *et al.*, 1989; Moingeon *et al.*, 1989). By studying purified LFA-3 incorporated in artificial lipid bilayers, we have found that the lateral mobility of adhesion receptors can enhance significantly the adhesion strength by allowing accumulation of receptor-ligand pairs in the cell contact area and by increasing the rate of receptor-ligand bond formation (Chan *et al.*, 1991).

We have used LFA-3 to study whether lengthening an adhesion molecule could improve its efficiency. Both CD2 and LFA-3 contain two Ig-like domains, whereas the adhesion molecules ICAM-1 and VCAM-1 contain five and seven Ig-like domains, respectively (reviewed in Springer, 1990a). Because CD2 and LFA-3 are predicted to be short molecules, adhesion between them has been predicted to require closer membrane juxtaposition than several other adhesion mechanisms (Springer, 1990a). We have lengthened LFA-3 by inserting four Ig-like domains from ICAM-1 and compared its efficiency in cell-cell adhesion with wild-type LFA-3.

## MATERIALS AND METHODS

### *Construction of Plasmids with Chimeric LFA-3 Molecules*

LFA-3 was lengthened by insertion of ICAM-1 domains 2–5 by use of published methods (Kunkel, 1985; Peterson and Seed, 1987). LFA-3 and ICAM-1 (pCD1.8) cDNA expression plasmids were described previously (Seed, 1987; Staunton *et al.*, 1988). The sequence TATACC in LFA-3 codons 218–220 was converted to a unique *Kpn* I site, resulting in conversion of the fourth hydrophobic transmembrane res-

idue I219 to V. A *Kpn* I site in codons 91–93 at the predicted boundary of domains 1 and 2 in ICAM-1 was introduced during construction of the mutant L91A/AV (Staunton *et al.*, 1990). The CDM8 plasmids containing the mutated ICAM-1 and LFA-3 cDNAs were digested with *Kpn* I, cutting at the introduced *Kpn* I sites and a *Kpn* I site in CDM8. The fragments containing LFA-3 domains 1 and 2 and the ICAM-1 Ig-like domains 2–5, transmembrane, and cytoplasmic domains were ligated together, and the correct orientation was confirmed by restriction digestion. This construct designated 3IC1/D1.3 was further modified to obtain a chimeric LFA-3/ICAM-1 protein with a glycosyl-phosphatidylinositol (GPI) anchor using a second fragment exchange ligation with a plasmid that contains a cDNA encoding GPI-anchored ICAM-1. GPI-anchored ICAM-1 was constructed as follows. A unique *Afl* II site in LFA-3 was generated with the mutation C2051/LN at a location two residues amino-terminal to the predicted GPI anchor attachment site at S208 (Ferguson and Williams, 1988). An *Afl* II site was generated at L448 in ICAM-1 between the end of domain 5 and the transmembrane sequence. Using a *Bam*HI site in the CDM8 vector, the *Afl* II-*Bam*HI fragment containing the GPI reanchoring sequence for LFA-3 was inserted in the ICAM-1 plasmid cut with *Afl* II and *Bam*HI to generate GPI-anchored ICAM-1 (plasmid IC1/GPI1.4). A unique *Bgl* II site in domain 5 of ICAM-1 and a *Bam*HI site in the vector were then used for a fragment exchange ligation between the 3IC1/D1.3 and IC1/GPI1.4 plasmids to generate a plasmid (3IC1/D1.3/GPI) that encodes the GPI-anchored LFA-3/ICAM-1 chimeric glycoprotein.

### *Monoclonal Antibodies (mAbs), Cell Lines, and Cell Preparations*

The anti-LFA-3 mAb TS2/9 (IgG1), the anti-CD11a mAb TS1/22 (IgG1) (Sanchez-Madrid *et al.*, 1982), and the nonbinding mAb X63 (IgG1) were used as hybridoma supernatants. The anti-ICAM-1 mAb CL203 (IgG1) (Matsui *et al.*, 1987) was used as purified antibody. The anti-integrin  $\beta$ 1 (CD29) mAb, AIB2 (Werb *et al.*, 1989), was used as hybridoma supernatant.

The dihydrofolate reductase (dhfr)-deficient Chinese hamster ovary (CHO) cell line, DG44, and the plasmid, pDCH1P, containing a Chinese hamster dhfr minigene were generous gifts of L. Chasin (Columbia University, New York, NY) (Urlaub *et al.*, 1986). DG44 was maintained in culture in alpha-Eagle's minimum essential medium without nucleosides and deoxynucleosides, containing 10% fetal calf serum (FCS), 100  $\mu$ M hypoxanthine, 16  $\mu$ M thymidine, 5 mM glutamine, and 50  $\mu$ g/ml gentamycin. The T-lymphoma cell lines Jurkat and SKW3 were maintained in RPMI 1640 medium containing 10% FCS, 5 mM glutamine, and 50  $\mu$ g/ml gentamycin and were used in the log phase of growth ( $6-9 \times 10^5$  cells/ml). Peripheral blood-enriched CD2-expressing cells were prepared by isolating interphase mononuclear blood cells with Ficoll-Hypaque (1.077 density; Sigma, St. Louis, MO) and depleting monocytes on tissue-culture plastic and B lymphocytes through nylon wool (Cellular Products, Buffalo, NY). They were typically over 95% CD2-positive.

### *Transfection for Stable LFA-3 Expression*

DG44 cells at 10–20% confluence on 10-cm tissue-culture dishes were cotransfected with 20  $\mu$ g LFA-3 or LFA-3/ICAM-1 cDNA plasmid plus 1  $\mu$ g pDCH1P plasmid, using a modified method of calcium phosphate precipitation (Chen and Okayama, 1987). Selection of stable transfectants began 3 d later by replacing FCS with dialyzed FCS (Hazletine Biologicals, Lenexa, KS) and omitting hypoxanthine in the culture medium. LFA-3 expression on the stable transfectant lines was amplified in 50 nM methotrexate. Clones expressing different levels of LFA-3 were obtained from the transfectant lines by limiting dilution. Stable transfectant clones were always maintained in culture in the presence of 50 nM methotrexate.

### *Flow Cytometry*

Stable CHO transfectants were analyzed by flow cytometry for LFA-3 expression by first staining with a nonbinding mAb X63 or the

anti-LFA-3 mAb TS2/9 and then with fluorescein isothiocyanate-conjugated goat F(ab')<sub>2</sub> anti-mouse Ig (Tago, Burlingame, CA). For transfectants expressing LFA-3/ICAM-1 chimeric glycoproteins, cells were in addition stained with anti-ICAM-1 mAb CL203 (Staunton *et al.*, 1990).

### Immunoprecipitation Analysis

CHO transfectants ( $2-3 \times 10^6$  cells) were surface iodinated with 0.6 mCi <sup>125</sup>I using Iodogen (Markwell and Fox, 1978). Ice-cold cell lysates in 25 mM tris(hydroxymethyl)aminomethane-HCl (pH 8.0) containing 1% Triton X-100, 150 mM sodium chloride, 0.02% sodium azide, 1 mM phenylmethylsulfonyl fluoride, 0.15 trypsin inhibitor units/ml aprotinin, and 5 mM iodoacetamide were precleared overnight with 50  $\mu$ l packed Sepharose (Pharmacia, Uppsala, Sweden) CL-4B coupled with an irrelevant IgG, followed by incubation with 10  $\mu$ l packed TS2/9-coupled Sepharose CL-4B for 6 h. LFA-3 immunoprecipitates were eluted from the Sepharose and analyzed by 8% sodium dodecyl sulfate-polyacrylamide gel electrophoresis (SDS-PAGE) or isoelectric focusing (ampholytes pl 2.5–5.0, Pharmacia, Uppsala, Sweden; or pl 3–10, Bio-Rad, Richmond, CA) on minislab gels (Bio-Rad) under non-reducing conditions.

### Cell-Cell Adhesion Assay

CHO stable transfectant clones were plated in alternate rows on 96-well tissue-culture plates to reach confluence on the day of adhesion assay. Seeding density was adjusted for the slightly different growth rate of individual clones such that an equal number of cells were used for the assays. The CHO monolayer cells were washed four times in Hank's balanced salt solution containing 25 mM *N*-2-hydroxyethylpiperazine-*N'*-2-ethanesulfonic acid (HEPES) (pH 7.4), 0.5% bovine serum albumin (BSA), and 1 mM magnesium chloride (binding medium). CD2-expressing T cells (Jurkat, SKW3, or peripheral blood-enriched T lymphocytes) were labeled with 17  $\mu$ g/ml 2',7'-bis-(2-carboxyethyl)-5 (and-6) carboxyfluorescein (acetoxymethyl ester) (BCECF) (Molecular Probes, Eugene, OR) at 22°C for 20 min, washed, and dispensed at  $10^5$  cells/well in a total volume of 100  $\mu$ l. Both the CD2-expressing cells and the CHO transfectants were equilibrated (to 4, 22, or 37°C) as indicated with binding medium before assays.

Assay of Jurkat or SKW3 cell adhesion to the CHO transfectants was a modified version of the centrifugal cell dislodgement assay (McClay *et al.*, 1981). The cells were allowed to settle and bind to the CHO cell monolayers for 10 min. The microtiter wells were then filled with binding medium, sealed with adhesive carpet tape (Anchor Continental, Columbia, SC), taking care to avoid trapping air bubbles, and centrifuged inverted under  $100 \times g$  force for 10 min. Centrifugation was carried out at the same temperature as the adhesion; one exception is that cells adhered at 37°C were centrifugally dislodged at 22°C. After centrifugation, the adhesive tape was swiftly removed with the microtiter plates right-side-up and the top half portion of the binding medium was aspirated from individual wells. The complete removal of unbound T cells was confirmed by microscopic examination that revealed no T cells in suspension in the wells immediately after the procedure. For adhesion assays conducted at 22 and 37°C, Jurkat and SKW3 cells were pretreated with (1:4) anti-CD11a(LFA-1) mAb TS1/22 and anti-CD29 mAb AIB2 for 30 min at 0°C to minimize background adhesion to CHO cells via these molecules across the human/Chinese hamster species barrier. Excess antibodies were removed by washing before the treated cells were used.

The plate inversion assay used to assess the adherence of peripheral blood-enriched T lymphocytes to the CHO transfectants has been described previously (Chan *et al.*, 1991). This adhesion assay provides a more gentle removal of nonspecifically adherent cells and allows the measurement of adherent peripheral blood-enriched T cells, which bound to the CHO transfectants less tightly than the Jurkat and SKW3 cell lines. Peripheral blood-enriched T cells were allowed to settle and bind to the CHO transfectants for 1 h. The microtiter wells were then filled with binding medium and inverted in a beaker of phosphate-

buffered saline containing 0.1% BSA and 1mM MgCl<sub>2</sub>. Unbound cells were detached under gravity for 1 h.

For both assays, bound cells were measured on a fluorescence plate reader (Pandex, Baxter Health Corp, Mundelein, IL). The percentage of bound T cells was calculated by dividing the fluorescence of bound cells by the total fluorescence of input cells in microtiter wells. The specific percentage of T cells adhered to LFA-3-expressing CHO transfectants was obtained by subtracting the basal percentage of T cells bound to a LFA-3-negative CHO transfectant clone (CHO. LFA-3:N).

### Treatment with Deoxymannojirimycin and Neuraminidase

CHO clones were seeded in 96-well tissue-culture plates 2–3 d before cell-cell adhesion assays. Deoxymannojirimycin (Calbiochem, La Jolla, CA) was included at 0, 150, 300, and 500  $\mu$ M in the last 40–44 h of culture. The growth rate of CHO clones was not affected by deoxymannojirimycin at the dosage used, as determined by cell counting. For treatment with *Vibrio cholera* neuraminidase (Calbiochem), confluent CHO transfectant monolayers in 96-wells were incubated with the enzyme in culture medium at 0, 0.05, 0.1, and 0.2 units/ml at 37°C, 5% CO<sub>2</sub>, for 1 h. The confluent cell monolayers were washed four times with ice-cold binding medium before assay. To test the efficiency of deoxymannojirimycin treatment, CHO clones seeded on 10-cm tissue-culture dishes and cultured in the presence of the highest dose of inhibitor (500  $\mu$ M) were iodinated and subjected to immunoprecipitation of the LFA-3 and chimeric LFA-3/ICAM-1 glycoproteins. To test the efficiency of neuraminidase treatment, CHO cells were detached with 5 mM EDTA in Hank's balanced salt solution with 25 mM HEPES, pH 7.4, before being treated with the highest dose of enzyme (0.2 units/ml) to maximize cleavage of sialic acids from the entire cell surface. The treated cells were iodinated and subjected to immunoprecipitation as described above.

### Adhesion Assay with LFA-3 on Planar Membranes

The GPI isoform of LFA-3 (0.6  $\mu$ g) immunoaffinity purified from human erythrocytes (Dustin *et al.*, 1987a) was treated with and without 0.1 unit/ml neuraminidase in 0.2 M sodium acetate buffer (pH 5.5) containing 1% *n*-octyl- $\beta$ -glucopyranoside (OG), 5 mM calcium acetate, at 37°C for 24 h. An aliquot (0.1  $\mu$ g) was analyzed for the extent of digestion by SDS-PAGE. The remainder of the digestion mixture was mixed in a dilution series with egg phosphatidylcholine lipids for reconstitution into liposomes by OG dialysis (Mimms *et al.*, 1981; Chan *et al.*, 1991). Planar membranes were formed by fusion of the liposomes on glass coverslips at the bottom of 96-well microtiter plates and cell adhesion assayed as described previously (Chan *et al.*, 1991). In brief, BCECF-labeled Jurkat cells ( $10^5$  cells/well) were allowed to settle under gravity and bind to membranes containing LFA-3 at 4°C for 1 h. Unbound cells were removed by gravity upon inverting the microtiter plates in phosphate-buffered saline containing 0.1% BSA at 4°C for 1 h. Jurkat cells did not adhere to membranes lacking LFA-3 or to the glass surface. The percentage of bound cells was calculated as described above in cell-cell adhesion assays.

## RESULTS

### Stable Expression of LFA-3 and Chimeric LFA-3/ICAM-1 on CHO Cells

To investigate the effect of lengthening LFA-3 on cell-cell adhesion, chimeric LFA-3 containing a spacer between the extracellular domains and the GPI anchor was generated (Figure 1). A cDNA sequence encoding the Ig-like domains 2 to 5 of ICAM-1 was inserted between the cDNA sequences encoding the two Ig-like

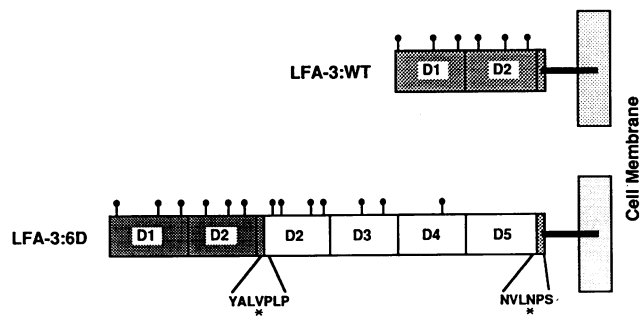

**Figure 1.** Schematic diagram of the wild-type LFA-3 and the chimeric LFA-3/ICAM-1 glycoproteins. Glycosylation sites are indicated as lollipop. Segments of LFA-3 and ICAM-1 are dark and white, respectively, and Ig domain numbers refer to the native molecules. Amino acids mutated at the joints in the constructs are marked by asterisks. Thick solid bars represent GPI anchorage of the glycoproteins in the cell membrane.

extracellular domains and the GPI anchor of LFA-3 by recombinant DNA manipulation. The first domain of ICAM-1 containing the LFA-1 binding site (Staunton *et al.*, 1990) was excluded in the cDNA construct to eliminate LFA-1/ICAM-1-mediated adhesion. The third domain of ICAM-1 that binds Mac-1 (Diamond *et al.*, 1991) is retained in this construct, but the T-cell lines tested in these studies for binding to the construct lack expression of Mac-1 (Miller *et al.*, 1986). CHO transfectants were established with wildtype LFA-3 (CHO.LFA-3:WT) or the 6 domain construct (CHO.LFA-3:6D), and clones with low or high expression (L and H suffix, respectively) were established (Figure 2A). Control transfectants with no LFA-3 expression (CHO.LFA-3:N) were also obtained. Both CHO.LFA-3:6D clones expressed an ICAM-1 epitope on domain 4 (Staunton *et al.*, 1990) defined by mAb CL203 (Figure 2B is representative). The level of expression remained constant during culture for months. SDS-PAGE of material precipitated with the LFA-3 mAb showed that the lengthened chimeric LFA-3/ICAM-1 molecule is 117  $M_r$  and the wild-type LFA-3 molecule is 71  $M_r$  (Figure 3, lane 1 and 2). The difference of 46 kDa is accounted for by the four ICAM-1 domains.

### T-Cell Adhesion at 4°C

The effect of lengthening LFA-3 on adhesion to CD2-expressing T cells was examined with a centrifugal cell dislodgement assay. Experiments were performed at 4°C to specifically measure the temperature independent CD2/LFA-3 mediated adhesion (Shaw *et al.*, 1986; Dustin *et al.*, 1987a; Plunkett *et al.*, 1987; Selvaraj *et al.*, 1987c), because we found at higher temperatures a background of human T-cell binding to mock transfected CHO cells that was integrin-dependent. Insertion of the four ICAM-1 domains into LFA-3 markedly enhanced binding of two different CD2<sup>+</sup> T-cell lines and

peripheral blood T lymphocytes (Figure 4). Enhancement of Jurkat binding was substantial for CHO clones expressing both low and high levels of LFA-3. Binding of SKW3 and peripheral blood T cells was less efficient overall, but enhancement from lengthening was even more dramatic. In all cases, binding was greater to the CHO.LFA-3:6D.L clone than to CHO.LFA-3:WT.H clone, showing that the effect of length was more important than the 2.2-fold difference in surface expression on these clones.

### Effects of Neuraminidase and Deoxymannojirimycin Treatment

To test if the enhanced efficiency of the lengthened LFA-3 molecule in support of T-cell adhesion was attributable to the reduced cell-cell repulsion when the CD2-binding

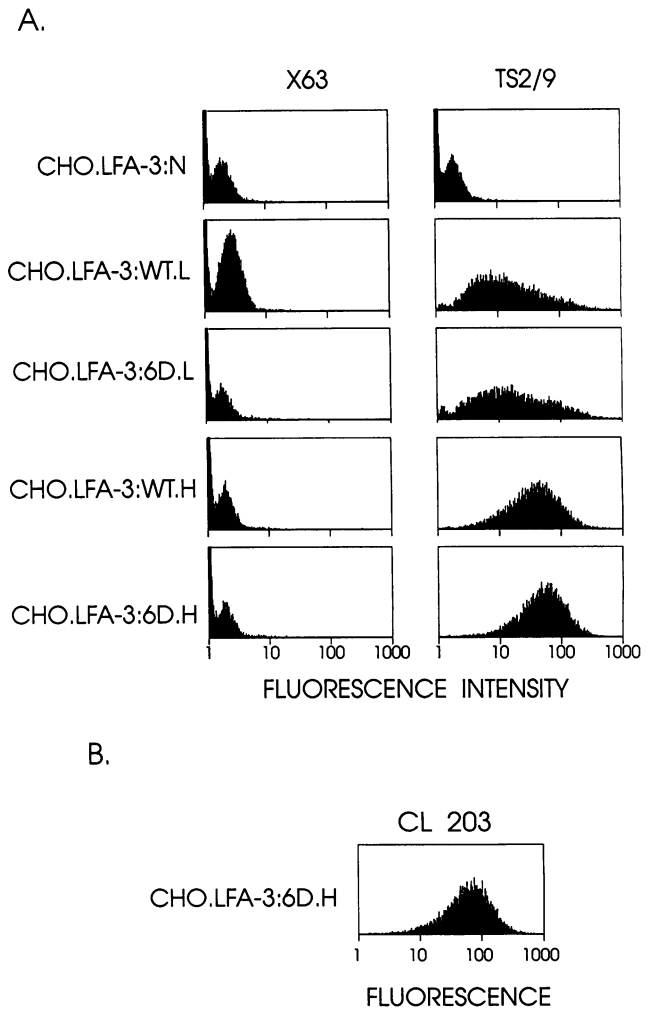

**Figure 2.** Flow cytometric analyses of CHO transfectant clones. (A) CHO clones were stained with nonbinding mAb X63 and anti-LFA-3 mAb TS2/9. (B) The CHO.LFA-3:6D.H clone was stained with CL203 mAb.

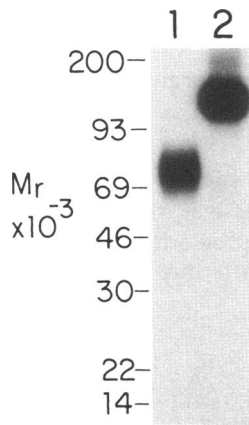

**Figure 3.** SDS-PAGE analysis of LFA-3 adhesins expressed on CHO clones. Surface iodinated CHO.LFA-3:WT.H (lane 1) and CHO.LFA-3:6D.H (lane 2) were subjected to immunoprecipitation with anti-LFA-3 mAb TS2/9 and 8% SDS-PAGE under nonreducing conditions.

site on LFA-3 was brought farther away from the negatively charged CHO cell surface, the cell-surface charge and the bulk of glycosylation on the CHO clones were modified by treatment with neuraminidase or deoxymannojirimycin. Neuraminidase treatment slightly enhanced binding of all CHO.LFA-3:WT and CHO.LFA-3:6D clones to Jurkat cells (Figure 5A).

The greatest enhancement (5-fold) was seen when the wild-type LFA-3 was expressed at a low level (CHO.LFA-3:WT.L clone). Deoxymannojirimycin blocks the conversion of high-mannose oligosaccharide side chains to complex or hybrid-type oligosaccharide side-chains and polylectosaminoglycan moieties, resulting in a reduction in negative charge and glycocalyx bulk (Fuhrmann *et al.*, 1984). It did not alter the expression level of LFA-3 on the CHO clones or the growth rate of the cells in the range of doses used. Deoxymannojirimycin treatment of the CHO clones slightly enhanced Jurkat cell binding in a dose-dependent manner to all CHO.LFA-3:WT and CHO.LFA-3:6D clones (Figure 5B), to an extent comparable with neuraminidase treatment.

Overall, the contribution of length to LFA-3 binding efficiency was stronger than the effect of decreasing surface charge or glycocalyx bulk; neither of the latter treatments increased the binding efficiency of the wild-type LFA-3 to the same level as seen with the untreated lengthened LFA-3. To characterize the efficiency of neuraminidase and deoxymannojirimycin treatment, the wild-type LFA-3 and chimeric LFA-3/ICAM-1 molecules were immunoprecipitated from the CHO.LFA-3:WT.H and CHO.LFA-3:6D.H clones, respectively. Treatment with neuraminidase at 0.2 units/ml converted a series of acidic components to a single neutral component for both wild-type LFA-3 (Figure 6A, lane 5 compared with lane 1) and chimeric LFA-3/ICAM-1 (Figure 6A, lane 6 compared with lane 3). Treatment with deoxymannojirimycin at 500  $\mu$ M resulted in a basic shift in the isoelectric points of both wild-type (Figure 6A, lane 2 compared with lane 1) and chimeric LFA-3 (Figure 6A, lane 4 compared with lane 3). In addition,

it resulted in the reduction in the relative molecular weight of wild-type LFA-3 from 71 to 48 kDa (Figure 6B, lane 3 compared with lane 1) and of chimeric LFA-3/ICAM-1 from 117 to 104 kDa (Figure 6B, lane 4 compared with lane 2). The greater reduction in size of wild-type than extended LFA-3 is consistent with the presence of polylectosaminoglycan moieties on GPI-anchored LFA-3 (Chan and Springer, unpublished observation) and the importance of membrane proximity for this modification (Fukuda *et al.*, 1988). Removal of

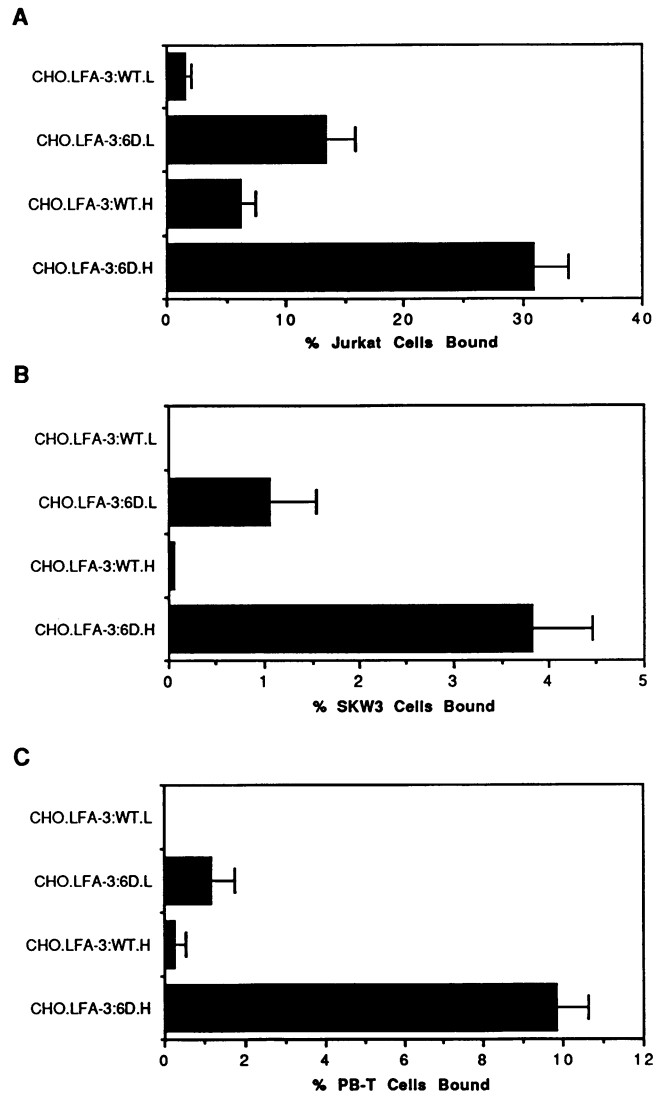

**Figure 4.** Adhesion of (A) Jurkat, (B) SKW3, and (C) peripheral blood-enriched T cells to CHO clones at 4°C. Binding to the indicated transfected CHO clones was assayed as described in MATERIALS AND METHODS. The nonspecific cell binding to the LFA-3-negative CHO.LFA-3:N clone of  $1.6 \pm 0.6\%$  for Jurkat cells,  $1.2 \pm 0.5\%$  for SKW3 cells, and  $0 \pm 0\%$  for peripheral blood-enriched T cells was subtracted. Results are representatives of two to five experiments. Error bars indicate SDs of binding of triplicate samples. There was no specific binding of CHO.LFA-3: WT.L cells in B and C.

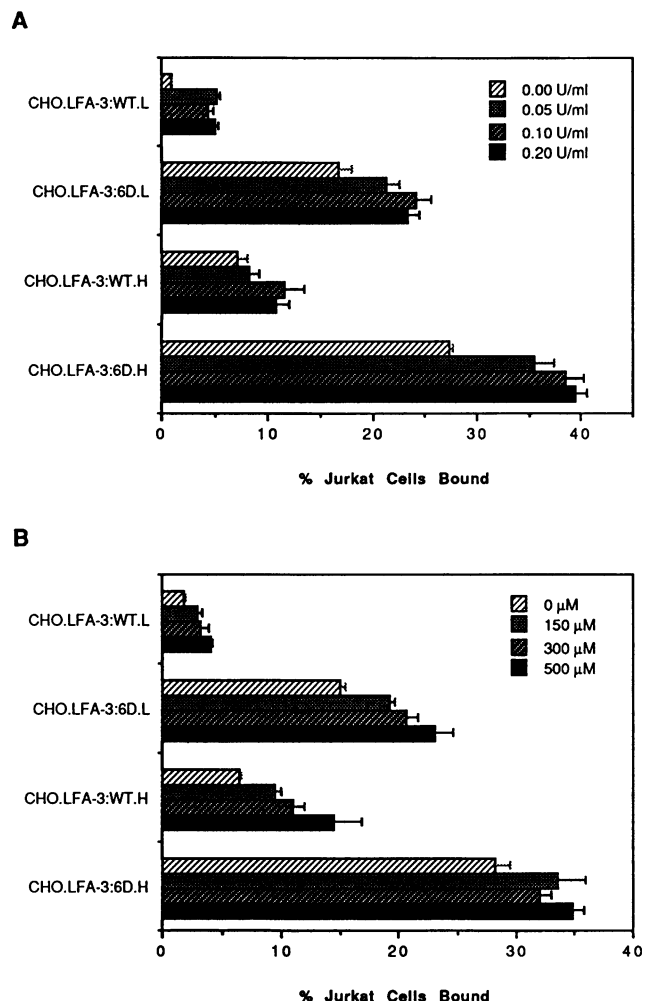

**Figure 5.** Effects of (A) neuraminidase and (B) deoxymannojirimycin treatment on Jurkat cell binding to CHO clones at 4°C. CHO clones in 96-well microtiter plates were pretreated with different concentrations of neuraminidase for 1 h or cultured for 44–48 h in the presence of different concentrations of deoxymannojirimycin before use. Results are representative of two experiments. Error bars indicate SDs of binding of triplicate samples.

polylactosaminoglycans from purified LFA-3 did not affect its ability when incorporated in planar membranes to bind Jurkat cells (Chan and Springer, unpublished observations).

To test if the reduction of negative charge on LFA-3 itself contributed to the slightly enhanced Jurkat cell adhesion, we tested Jurkat cell binding to wild-type LFA-3 treated with or without *Vibrio cholera* neuraminidase (0.1 unit/ml) before incorporation into neutral egg phosphatidylcholine planar membranes. The amount of binding of Jurkat cells to neuraminidase-treated LFA-3 and untreated LFA-3 was very similar (Figure 7). Further removal by β-galactosidase of the galactosides that were exposed on digestion of terminal sialic acids by neuraminidase also did not alter Jurkat cell binding (Figure 7). These findings suggest that the enhanced

Jurkat cell binding to neuraminidase- or deoxymannojirimycin-treated CHO transfectants was attributable to an overall reduction of negative charge and bulk of glycocalyx on the CHO cell surface.

#### T-Cell Adhesion at 22 and 37°C

T-cell adhesion to the CHO clones was assayed at 22 and 37°C under conditions where the adhesion molecules might more readily redistribute into the cell-cell

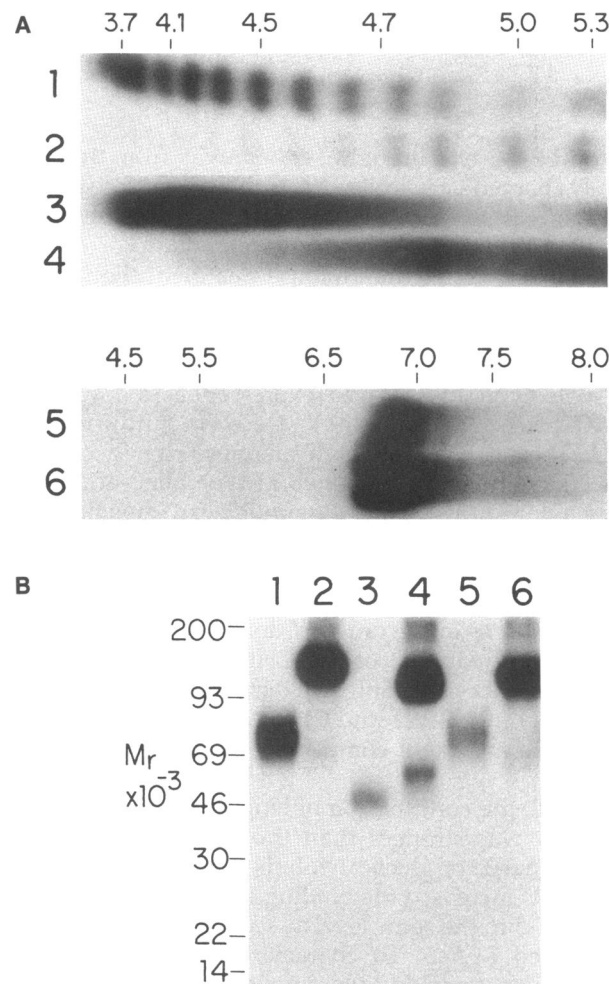

**Figure 6.** Characterization of wild-type LFA-3 and chimeric LFA-3/ICAM-1 glycoproteins on CHO clones treated with neuraminidase and deoxymannojirimycin. CHO.LFA-3:WT.H and CHO.LFA-3:6D.H clones treated with 0.2 units/ml neuraminidase or 500 μM deoxymannojirimycin were surface iodinated and subjected to immunoprecipitation with anti-LFA-3 mAb TS2/9, analysis, and autoradiography. (A) isoelectric-focusing (with pI range 3.7–5.3 or 4.5–8.0 as indicated) of CHO.LFA-3:WT.H, untreated (lane 1) or treated with deoxymannojirimycin (lane 2) or neuraminidase (lane 5); or CHO.LFA-3:6D.H, untreated (lane 3), or treated with deoxymannojirimycin (lane 4) or neuraminidase (lane 6). (B) Eight percent, SDS-PAGE under nonreducing conditions of CHO.LFA-3: WT.H, untreated (lane 1), or treated with deoxymannojirimycin (lane 3) or neuraminidase (lane 5); or CHO.LFA-3:6D.H, untreated (lane 2) or treated with deoxymannojirimycin (lane 4) or neuraminidase (lane 6).

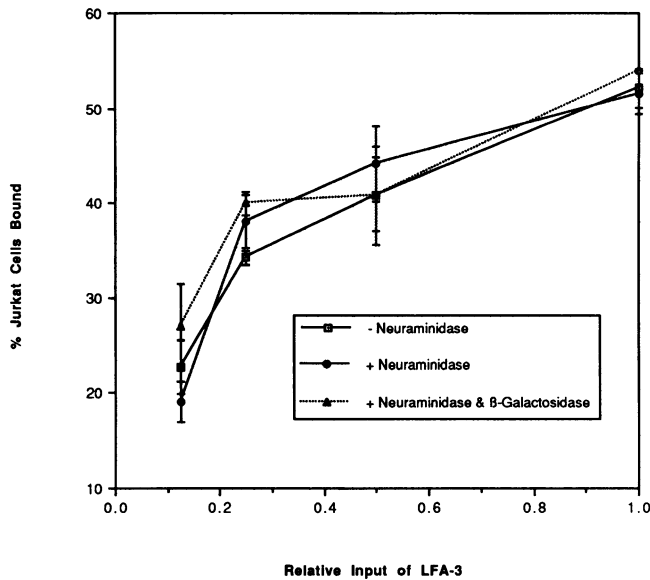

**Figure 7.** Jurkat cell binding to planar membranes containing purified wild-type LFA-3 treated with or without neuraminidase. Results are representatives of two experiments. Error bars indicate SDs of binding of triplicate samples.

contact area. Jurkat and SKW3 cells were pretreated with blocking mAbs to the integrin CD11a (LFA-1) and to the integrin CD29 (VLA integrin  $\beta$ 1 subunit) to minimize cell adhesion mediated by temperature-dependent adhesion pathways, but a substantial background that was subtracted was still apparent for Jurkat and PB T-cell binding to the CHO.LFA-3:N clone (see Figure 8). There was little or no increase in binding of Jurkat or PB T cells to the extended LFA-3 construct expressed at the higher density (CHO.LFA-3:6D.H) at 22 or 37°C compared with 4°C (Figure 8, A and B compared with Figure 4A and Figure 8, E and F compared with Figure 4C), but binding of the CHO.LFA-3:6D.L and CHO.LFA-3:WT constructs increased substantially at the higher temperatures. Binding of SKW3 cells to all the transfected CHO lines was more efficient at the higher temperatures (Figure 8, C and D compared with Figure 4B). The effect of lengthening LFA-3 was diminished but still significant. The effect of lengthening was apparent for Jurkat cells at 22°C but less so at 37°C (Figure 8, A and B). The extra Ig domains added to LFA-3 enhanced binding at both low and high levels of expression at 22°C and at the high level at 37°C for both SKW3 and Jurkat cells (Figure 8, A–D). However, lengthening had little effect on PB T-cell binding at 22 or 37°C (Figure 8, E and F).

## DISCUSSION

The contact sites in cell adhesion molecules are commonly located in the most membrane-distal domain (Springer, 1990b; Walz *et al.*, 1990). Although there is

substantial variation in the number of domains that are interposed between the adhesive contact site and the membrane, the significance of variation is unknown, and we have therefore tested the effect of lengthening the LFA-3 molecule from two to six Ig-like domains by interposing four Ig-like domains of ICAM-1 between the LFA-3 Ig-like domains and the membrane anchor. Both the chimeric lengthened molecule and wild-type LFA-3 were anchored by phosphatidyl inositol to eliminate effects attributable to differences in membrane anchors. At the temperature of 4°C where diffusion of membrane glycoproteins is minimized, the lengthened LFA-3 molecule was 4- to 20-fold more efficient than the wild-type LFA-3 molecule in adhesion to a variety of cell types expressing CD2. The results suggest that the efficiency of cell–cell adhesion is enhanced when the adhesive binding site is extended away from the cell membrane anchor. At higher temperatures, the efficiency of binding to the wild-type LFA-3 increased.

We compared the effect of lengthening LFA-3 with the effect of cell-surface charge. The influence of cell-surface charge previously has been explored using T-lymphocyte rosetting with erythrocytes, an interaction mediated by binding of CD2 on the T lymphocyte to LFA-3 on the human or sheep erythrocyte (reviewed in Springer, 1990b). Rosetting has been used for two decades as a clinical assay for the percentage of T lymphocytes in peripheral blood, and the parameters governing it have been carefully explored. Rosetting is improved by neuraminidase or protease treatment or by chemical derivatizations that add positive charge to the erythrocyte surface. Human T cells rosette with human erythrocytes only if the cell-surface negative charge is reduced or if the density of LFA-3 is increased by incorporation of exogenous LFA-3. We found that cell-surface charge and glycocalyx content as modulated by neuraminidase and deoxymannojirimycin, respectively, had an influence on cell adhesion. The influence was less than expected on the basis of studies of rosetting, but the rosetting studies have used circulating cells that may have a higher negative charge density. In our system, the enhancing effect of reducing cell–cell repulsion was significantly less than the enhancing effect of extending the receptor binding site of LFA-3 away from its membrane anchor site. Furthermore, removal of sialic acid and of much of the bulk of N-linked carbohydrate enhanced binding of cells bearing both wild-type and lengthened LFA-3. These results suggest that the lengthened LFA-3 mediates more efficient cell binding, not because the effects of cell–cell repulsion are attenuated because the cells do not have to come into as close proximity, but because the adhesive binding sites can more readily ligate to the counter-receptor on the apposing cell.

The rate and extent of adhesive bond formation are affected by lateral diffusivity of adhesion receptors, as shown in a model system in which CD2-bearing T cells interact with mobile or immobile LFA-3 in artificial

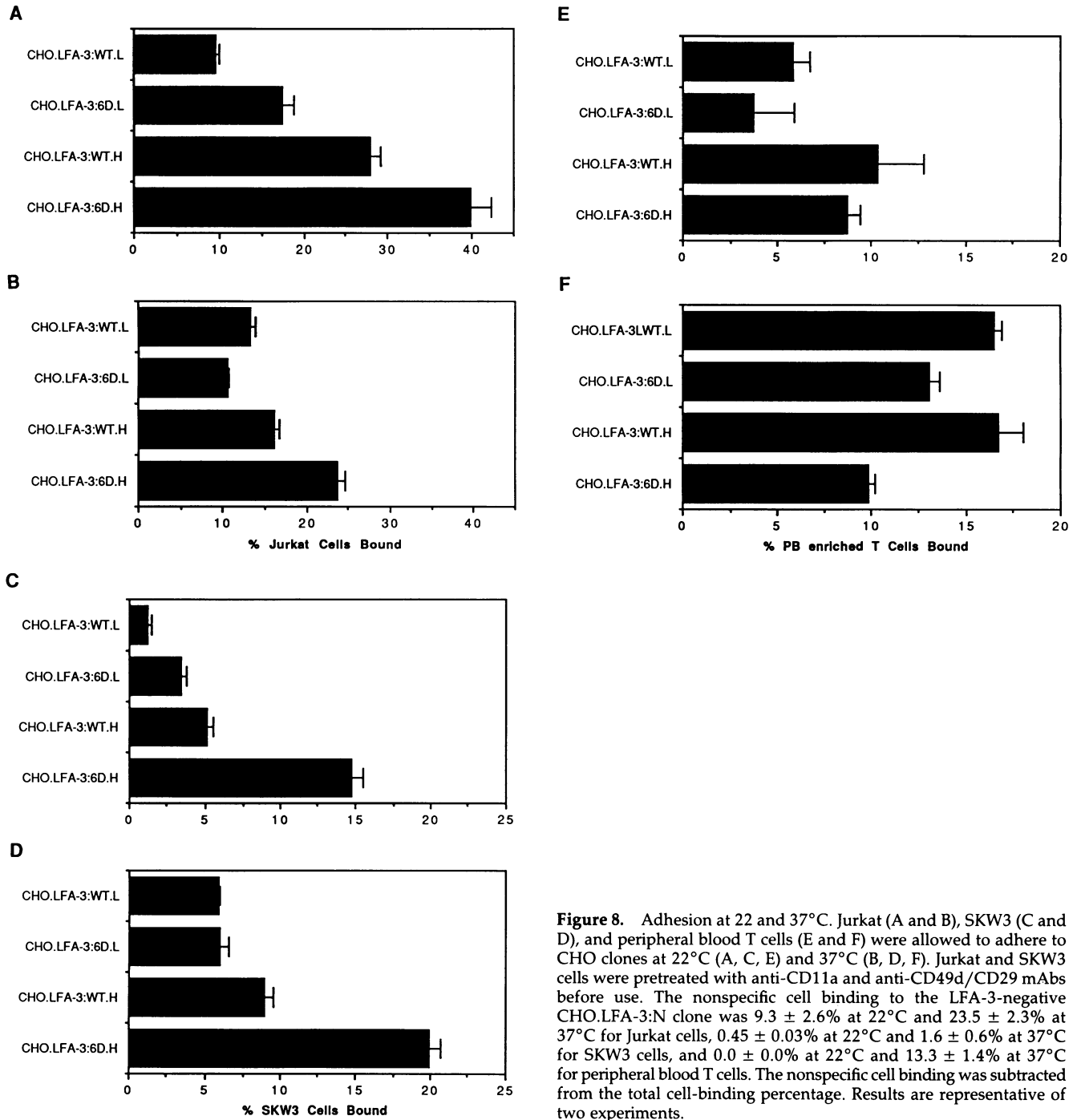

**Figure 8.** Adhesion at 22 and 37°C. Jurkat (A and B), SKW3 (C and D), and peripheral blood T cells (E and F) were allowed to adhere to CHO clones at 22°C (A, C, E) and 37°C (B, D, F). Jurkat and SKW3 cells were pretreated with anti-CD11a and anti-CD49d/CD29 mAbs before use. The nonspecific cell binding to the LFA-3-negative CHO.LFA-3:N clone was  $9.3 \pm 2.6\%$  at 22°C and  $23.5 \pm 2.3\%$  at 37°C for Jurkat cells,  $0.45 \pm 0.03\%$  at 22°C and  $1.6 \pm 0.6\%$  at 37°C for SKW3 cells, and  $0.0 \pm 0.0\%$  at 22°C and  $13.3 \pm 1.4\%$  at 37°C for peripheral blood T cells. The nonspecific cell binding was subtracted from the total cell-binding percentage. Results are representative of two experiments.

membrane bilayers (Chan *et al.*, 1991). At 4°C, glycoproteins diffuse more slowly than at 22 or 37°C (Petit and Edidin, 1974). Our results suggest that the binding efficiency of the wild-type LFA-3 more nearly approached the binding efficiency of the extended LFA-3 at 37°C; however, it was difficult to determine whether this was due to enhanced lateral mobility or to cooperation with temperature-dependent background

adhesion to CHO cells. The lengthened LFA-3 molecules may be particularly efficient at 4°C because they can extend further radially, in the direction parallel to the membrane. CD2 molecules are present at a density of about 100 sites/ $\mu\text{m}^2$  on Jurkat cells and are hence on average 100 nm apart (Chan *et al.*, 1991). Rough approximations based on the size of Ig domains and the measured size of ICAM-1 in the electron microscope



(Springer, 1990b; Staunton *et al.*, 1990) suggest that wild-type and extended LFA-3 may be 8 and 23 nm long, respectively. As the average distance apart of CD2 molecules on Jurkat cells is greater than the length of extended LFA-3 but of the same order of magnitude, lengthening could increase substantially the fraction of LFA-3 molecules that can reach and bind a CD2 molecule. However, lateral diffusion allows movement of membrane anchors within the plane of the membrane and is an alternative mechanism to allow the adhesive binding sites of two receptors to come into close proximity.

## ACKNOWLEDGMENTS

We thank B. Seed for the GPI-anchored LFA-3 cDNA, D. Staunton for making available the ICAM-1 cDNA mutants and helpful suggestions, L. Chasin for the gift of CHO cell line and pCH1P plasmid, S. Ferrone and C. Damsky for mAbs, and E. Luther for excellent assistance in flow cytometric analysis. This work is supported by NIH grant CA-31798 (T.A.S.) and a postdoctoral fellowship from the National Cancer Institute of Canada (P.-Y.C.).

## REFERENCES

- Bentwich, Z., Douglas, S.D., Siegal, F.P., and Kunkel, H.G. (1973). Human lymphocyte-sheep erythrocyte rosette formation: some characteristics of the interaction. *Clin. Immunol. Immunopathol.* 1, 511-522.
- Chan, P.-Y., Lawrence, M.L., Dustin, M.L., Ferguson, L.M., Golan, D.E., and Springer, T.A. (1991). Influence of receptor lateral mobility on adhesion strengthening between membranes containing LFA-3 and CD-2. *J. Cell Biol.* 115, 245-255.
- Chen, C., and Okayama, H. (1987). High-efficiency transformation of mammalian cells by plasmid DNA. *Mol. Cell. Biol.* 7, 2745-2752.
- Denning, S.M., Tuck, D.T., Vollger, L.W., Springer, T.A., Singer, K.H., and Haynes, B.F. (1987). Monoclonal antibodies to CD-2 and lymphocyte function-associated antigen 3 inhibit human thymic epithelial cell-dependent mature thymocyte activation. *J. Immunol.* 139, 2573-2578.
- Diamond, M.S., Staunton, D.E., Marlin, S.D., and Springer, T.A. (1991). Binding of the integrin Mac-1 (CD11b/CD18) to the third Ig-like domain of ICAM-1 (CD54) and its regulation by glycosylation. *Cell* 65, 961-971.
- Dustin, M.L., Olive, D., and Springer, T.A. (1989). Correlation of CD2 binding and functional properties of multimeric and monomeric lymphocyte function associated antigen-3. *J. Exp. Med.* 169, 503-517.
- Dustin, M.L., Sanders, M.E., Shaw, S., and Springer, T.A. (1987a). Purified lymphocyte function-associated antigen-3 (LFA-3) binds to CD2 and mediates T lymphocyte adhesion. *J. Exp. Med.* 165, 677-692.
- Dustin, M.L., Selvaraj, P., Mattaliano, R.J., and Springer, T.A. (1987b). Anchoring mechanisms for LFA-3 cell adhesion glycoprotein at membrane surface. *Nature* 329, 846-848.
- Ferguson, M.A.J., and Williams, A.F. (1988). Cell surface anchoring of proteins via glycosyl-phosphatidylinositol structures. *Annu. Rev. Biochem.* 57, 285-320.
- Fuhrmann, U., Bause, E., Legler, G., and Ploegh, H. (1984). Novel mannosidase inhibitor blocking conversion of high mannose to complex oligosaccharides. *Nature* 307, 755-758.
- Fukuda, M., Guan, J.L., and Rose, J.K. (1988). A membrane-anchored form but not the secretory form of human chorionic gonadotropin-alpha chain acquires poly(lactosaminoglycan). *J. Biol. Chem.* 263, 5314-5318.
- Hollander, N., Selvaraj, P., and Springer, T.A. (1988). Biosynthesis and function of LFA-3 in human mutant cells deficient in phosphatidylinositol anchored proteins. *J. Immunol.* 141, 4283-4290.
- Krensky, A.M., Sanchez-Madrid, F., Robbins, E., Nagy, J., Springer, T.A., and Burakoff, S.J. (1983). The functional significance, distribution, and structure of LFA-1, LFA-2, and LFA-3: cell surface antigens associated with CTL-target interactions. *J. Immunol.* 131, 611-616.
- Kunkel, T.A. (1985). Rapid and efficient site-specific mutagenesis without phenotypic selection. *Proc. Natl. Acad. Sci. USA* 82, 488-492.
- Markwell, M.A.K., and Fox, C.F. (1978). Surface-specific iodination of membrane proteins of viruses and eucaryotic cells using 1,3,4,6-tetrachloro-3,6-diphenylglycoluril. *Biochemistry* 17, 4807-4817.
- Matsui, M., Temponi, M., and Ferrone, S. (1987). Characterization of a monoclonal antibody-defined human melanoma-associated antigen susceptible to induction by immune interferon. *J. Immunol.* 139, 2088-2095.
- McClay, D.R., Wessel, G.M., and Marchase, R.B. (1981). Intercellular recognition: quantitation of initial binding events. *Proc. Natl. Acad. Sci. USA* 78, 4975-4979.
- Miller, L.J., Schwarting, R., and Springer, T.A. (1986). Regulated expression of the Mac-1, LFA-1, p150,95 glycoprotein family during leukocyte differentiation. *J. Immunol.* 137, 2891-2900.
- Mimms, L.T., Zampighi, G., Nozaki, Y., Tanford, C., and Reynolds, J.A. (1981). Phospholipid vesicle formation and transmembrane protein incorporation using octyl glucoside. *Biochemistry* 20, 833-840.
- Moingeon, P., Chang, H.C., Wallner, B.P., Stebbins, C., Frey, A.Z., and Reinherz, E.L. (1989). CD2-mediated adhesion facilitates T lymphocyte antigen recognition function. *Nature* 339, 312-314.
- Peterson, A., and Seed, B. (1987). Monoclonal antibody and ligand binding sites of the T cell erythrocyte receptor (CD2). *Nature* 329, 842-846.
- Petit, V.A., and Edidin, M. (1974). Lateral phase separation of lipids in plasma membranes: effect of temperature on the mobility of membrane antigens. *Science* 184, 1183-1185.
- Plunkett, M.L., Sanders, M.E., Selvaraj, P., Dustin, M.L., and Springer, T.A. (1987). Rosetting of activated human T lymphocytes with autologous erythrocytes: definition of the receptor and ligand molecules as CD2 and lymphocyte function-associated antigen 3 (LFA-3). *J. Exp. Med.* 165, 664-676.
- Sanchez-Madrid, F., Krensky, A.M., Ware, C.F., Robbins, E., Strominger, J.L., Burakoff, S.J., and Springer, T.A. (1982). Three distinct antigens associated with human T lymphocyte-mediated cytotoxicity: LFA-1, LFA-2, and LFA-3. *Proc. Natl. Acad. Sci. USA* 79, 7489-7493.
- Seed, B. (1987). An LFA-3 cDNA encodes a phospholipid-linked membrane protein homologous to its receptor CD2. *Nature* 329, 840-842.
- Selvaraj, P., Dustin, M.L., Mitnacht, R., Hünig, T., Springer, T.A., and Plunkett, M.L. (1987a). Rosetting of human T-lymphocytes with sheep and human erythrocytes: comparison of human and sheep ligand binding using purified E receptor. *J. Immunol.* 139, 2690-2695.
- Selvaraj, P., Dustin, M.L., Silber, R., Low, M.G., and Springer, T.A. (1987b). Deficiency of lymphocyte function-associated antigen-3 (LFA-3) in paroxysmal nocturnal hemoglobinuria: functional correlates and evidence for a phosphatidylinositol membrane anchor. *J. Exp. Med.* 166, 1011-1025.
- Selvaraj, P., Plunkett, M.L., Dustin, M., Sanders, M.E., Shaw, S., and Springer, T.A. (1987c). The T lymphocyte glycoprotein CD2 (LFA-2/

- T11/E-Rosette receptor) binds the cell surface ligand LFA-3. *Nature* 326, 400–403.
- Shaw, S., Luce, G.E.G., Quinones, R., Gress, R.E., Springer, T.A., and Sanders, M.E. (1986). Two antigen-independent adhesion pathways used by human cytotoxic T cell clones. *Nature* 323, 262–264.
- Springer, T.A. (1990a). Adhesion receptors of the immune system. *Nature* 346, 425–433.
- Springer, T.A. (1990b). The sensation and regulation of interactions with the extracellular environment: the cell biology of lymphocyte adhesion receptors. *Annu. Rev. Cell Biol.* 6, 359–402.
- Staunton, D.E., Dustin, M.L., Erickson, H.P., and Springer, T.A. (1990). The arrangement of the immunoglobulin-like domains of ICAM-1 and the binding sites for LFA-1 and rhinovirus. *Cell* 61, 243–254.
- Staunton, D.E., Marlin, S.D., Stratowa, C., Dustin, M.L., and Springer, T.A. (1988). Primary structure of intercellular adhesion molecule 1 (ICAM-1) demonstrates interaction between members of the immunoglobulin and integrin supergene families. *Cell* 52, 925–933.
- Urlaub, G., Mitchell, P.J., Kas, E., Chasin, L.A., Funanage, V.L., Myoda, T.T., and Hamlin, J. (1986). Effect of gamma rays at the dihydrofolate reductase locus: deletions and inversions. *Somatic Cell Mol. Genet.* 12, 555–566.
- Wallner, B.P., Frey, A.Z., Tizard, R., Mattaliano, R.J., Hession, C., Sanders, M.E., Dustin, M.L., and Springer, T.A. (1987). Primary structure of lymphocyte function associated antigen-3 (LFA-3): the ligand of the T-lymphocyte CD2 glycoprotein. *J. Exp. Med.* 166, 923–934.
- Walz, G., Aruffo, A., Kolanus, W., Bevilacqua, M., and Seed, B. (1990). Recognition by ELAM-1 of the sialyl-Lewis x determinant on myeloid and tumor cells. *Science* 250, 1132–1135.
- Werb, Z., Tremble, P.M., Behrendtsen, O., Crowley, E., and Damsky, C.H. (1989). Signal transduction through the fibronectin receptor induces collagenase and stromelysin gene expression. *J. Cell Biol.* 109, 877–889.
- Yang, S.Y., Denning, S.M., Mizuno, S., Dupont, B., and Haynes, B.F. (1988). A novel activation pathway for mature thymocytes. *J. Exp. Med.* 168, 1457–1468.