



Published in final edited form as:

J Am Chem Soc. 2005 May 4; 127(17): 6170–6171. doi:10.1021/ja043884l.

Three-Component Coupling Reactions of Silylglyoxylates, Alkynes, and Aldehydes: A Chemoselective One-Step Glycolate Aldol Construction

David A. Nicewicz and Jeffrey S. Johnson*

Department of Chemistry, University of North Carolina at Chapel Hill, Chapel Hill, North Carolina 27599-3290

Multicomponent coupling reactions can effect sequential bond constructions and rapidly increase molecular complexity in a single synthetic operation. In this context, acylsilanes¹ have found broad utility as reagents that act as a center of reactivity for both nucleophiles and electrophiles by virtue of a [1,2]-Brook rearrangement.² Metalloacyanide^{3,4} and metallophosphite^{5,6} nucleophiles reveal latent (silyloxy)carbanions of acylsilanes following a nucleophilic addition/[1,2]-Brook rearrangement sequence (Scheme 1). Because silyl migration is facilitated by the stabilization of the nascent anion by the nitrile or phosphonate groups, one might conjecture that extant electron-withdrawing functionality in the acylsilane moiety may also promote silyl migration. For this reason silylglyoxylates⁷ (**1**), a class of acylsilanes that possess an embedded anion stabilizing group, captured our attention. Herein we report three-component coupling reactions of silylglyoxylates (**1**), terminal alkynes, and aldehydes to furnish glycolate aldols that bear two contiguous stereocenters (eq 1, Table 1).

Kuwajima⁸ and Reich⁹ have shown that alkynylation of aliphatic or vinylic acylsilanes initiates [1,2]-Brook rearrangement to furnish propargyl anions that can engage a variety of electrophiles (H⁺, DMF, 1° iodides, and disulfides) to give substituted silyloxyallenes. A constraint in this chemistry that is common to multicomponent couplings is reagent incompatibility: the high reactivity of the alkali and alkaline earth acetylides employed by Kuwajima and Reich necessitate a stepwise introduction of the acylsilane and terminating electrophiles. We were interested in testing the feasibility of a single-pot process in which the metal acetylide was generated in the presence of both electrophilic components. This would be viable only if the metal acetylide was a highly discriminating nucleophile; in situ metal acetylide formation with a Lewis acid and amine base as described by Carreira and Yamaguchi was the projected method of choice.^{10,11}

An evaluation of zinc salts confirmed the underlying premise and revealed ZnI₂ as the optimal Lewis acid to promote the desired three-component coupling.¹² The silylglyoxylate structure was initially optimized for conversion and diastereoselectivity by variation of the ester functionality.¹³ A screen of trimethylsilylglyoxylates indicated that *tert*-butyl trimethylsilylglyoxylate (**1a**) furnished the desired adducts in the highest levels of conversion and diastereocontrol.

Employing *tert*-butyl trimethylsilylglyoxylate (**1a**), we explored the scope of the reaction. The initial silyl ether adducts were found to be susceptible to O–O silyl migration during the course

jsj@unc.edu.

Supporting Information Available: Experimental details and analytical data for all new compounds, CSP-SFC traces of racemic **7** and enantioenriched **7**, and all stereochemical proofs. This material is available free of charge via the Internet at <http://pubs.acs.org>.

of the reaction and therefore were isolated as their derived acetonides. A variety of alkynes (alkyl, aryl, trimethylsilyl, and heteroatom-substituted) were tolerated, affording the intended adducts (**2/3**) in moderate to good yield (48–81%) and approximately 75:25 diastereoselectivity when benzaldehyde was the coupling partner (entries 1–5, Table 1). Substituted aromatic aldehydes also exhibited good reactivity and diastereoselectivity (75:25 to 80:20; entries 6–8, Table 1); disappointingly, aliphatic aldehydes were not suitable substrates. Cinnamaldehyde and 2-furaldehyde also provided the desired adducts in good yield, albeit with no diastereoselectivity (53:47; entries 9 and 10, Table 1).

A second round of modifications to the silyl glyoxylate structure was undertaken to further improve the diastereocontrol.¹³ Systematic variation of the silyl group revealed that by using *tert*-butyl *tert*-butyldimethylsilyl glyoxylate (**1b**), a marked increase in diastereoselectivity could be achieved (cf. Table 2, entries 1–3 with Table 1, entries 1, 2, and 6). The use of **1b** allows for the isolation of silyl-protected adducts (**4/5**) as differentially protected glycols. Furthermore, deprotection of (**4/5**) with TBAF (1.1 equiv) followed by a single recrystallization from hexanes afforded the diol in diastereomerically pure form (entry 2).

Although the zinc acetylide appears to react in a chemoselective manner with the silyl glyoxylate, we also considered the possibility of initial reversible alkynylation of the aldehyde. To test this hypothesis, a suspension of phenylacetylene, benzaldehyde, Et₃N, and ZnI₂ in toluene was allowed to stir for 48 h at –30 °C, giving rise to an undefined intermediate **A** (presumably a zinc alkoxide, Scheme 2). Aqueous ammonium chloride was added, and propargyl alcohol **6** was isolated in 99% yield. If intermediate **A** was instead treated with **1a**, after 24 h propargyl alcohol **6** was obtained 77% yield, whereas **2a** and **3a** were formed in ≤8% yield (employing the aforementioned deprotection/ketalization protocol).¹⁴ Because the propargyl alcohol is formed in high yield and only trace amounts of **2a/3a** were observed, we are inclined to believe that zinc acetylide addition to the silyl glyoxylate occurs as the result of a kinetic preference.

Initial experiments suggest that asymmetric induction may be realized in this tandem process. Using Carreira's conditions (Zn(OTf)₂/(+)-*N*-methylephedrine),¹¹ diol **7** was isolated after HCl/MeOH workup in 30% yield, 89:11 dr, and 64% ee (eq 3).

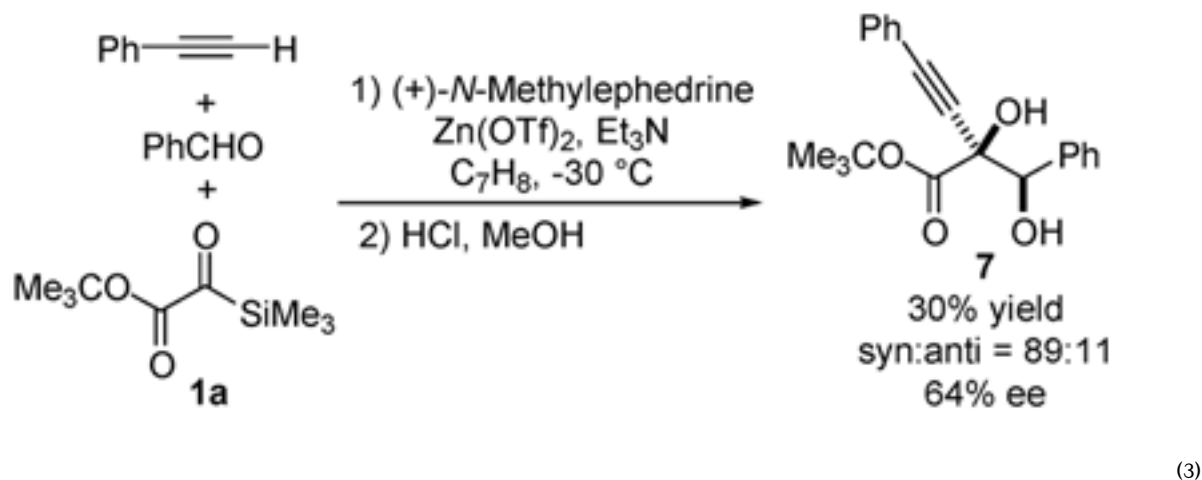

Not only was there a marked increase in diastereoselectivity relative to the ZnI₂ system (75:25 dr; cf. entry 1, Table 1), but it has been demonstrated, using unoptimized conditions, that an enantioselective version of the title reaction is possible.¹⁵

We have extended this three-component coupling concept to include aliphatic aldehydes (eq 4). Treatment of a solution of cyclohexanecarboxaldehyde and **1b** in THF at -78°C with vinyl Grignard results in the formation of glycol **8** in 76% yield and complete diastereoselectivity.

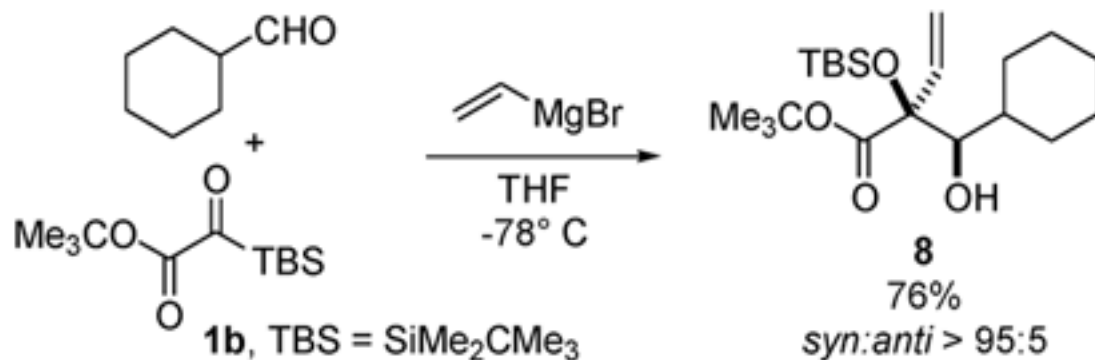

(4)

In summary, a tandem alkynylation/Brook rearrangement/aldol reaction of silyl glyoxylates has been reported. This mode of reactivity is divergent from that of the Kuwajima and Reich systems, affording glycolate aldols rather than silyloxyallene aldols. The reaction exhibits exquisite chemoselectivity at every potential branch point in the reaction sequence. The identity of the silyl glyoxylate (**1**) is crucial for diastereocontrol; however, diastereomerically pure diols of **4** can be isolated following a single recrystallization. Additionally, it has been shown that enantioselective variants are possible using simple enantiopure amino alcohols to mediate chirality transfer. It is noteworthy that the identical functional group arrays present in **4**¹⁶ and **8**¹⁷ have been utilized in natural product synthesis, illustrating the potential value of these processes.

Supplementary Material

Refer to Web version on PubMed Central for supplementary material.

Acknowledgments

We are grateful to the National Institutes of Health (National Institute of General Medical Sciences, GM068443) for support of this research. D.A.N. acknowledges a fellowship from Eli Lilly and an ACS Division of Organic Chemistry Fellowship sponsored by Novartis. J.S.J. is an Eli Lilly Grantee and a 3M Nontenured Faculty Awardee. Xin Linghu is thanked for experimental assistance.

References

1. Moser WH. *Tetrahedron* 2001;57:2065.
2. Brook AG. *Acc Chem Res* 1974;7:77.
3. (a) Reich HJ, Holtan RC, Bolm C. *J Am Chem Soc* 1990;112:5609. (b) Takeda K, Ohnishi Y. *Tetrahedron Lett* 2000;41:4169. (c) Degl'Innocenti A, Ricci A, Mordini A, Reginato G, Colotta V. *Gazz Chim Ital* 1987;117:645.
4. (a) Nicewicz DA, Yates CM, Johnson JS. *Angew Chem, Int Ed* 2004;43:2652. (b) Linghu X, Nicewicz DA, Johnson JS. *Org Lett* 2002;4:2957. [PubMed: 12182598] (c) Linghu X, Johnson JS. *Angew Chem, Int Ed* 2003;42:2534.
5. Takeda K, Tanaka T. *Synlett* 1999:705.
6. Linghu X, Potnick JR, Johnson JS. *J Am Chem Soc* 2004;126:3070. [PubMed: 15012135]

7. Bolm C, Kasyan A, Heider P, Saladin S, Drauz K, Guenther K, Wagner C. *Org Lett* 2002;4:2265. [PubMed: 12074683]
8. Kuwajima I, Kato M. *Tetrahedron Lett* 1980;21:623.
9. Reich HJ, Eisenhart EK, Olson RE, Kelly MJ. *J Am Chem Soc* 1986;108:7791.
10. Yamaguchi M, Hayashi A, Minami T. *J Org Chem* 1991;56:4091.
11. (a) Frantz DE, Fässler R, Carreira EM. *J Am Chem Soc* 2000;122:1806. (b) Anand NK, Carreira EM. *J Am Chem Soc* 2001;123:9687. [PubMed: 11572696]
12. ZnBr_2 and ZnCl_2 also effected the transformation; however, higher temperatures and reaction times were required.
13. See Supporting Information for details.
14. The yield of propargyl alcohol **6** was diminished by small amounts (<10%) of Meerwein–Ponndorf–Verley reduction of **1a**, presumably by intermediate A:

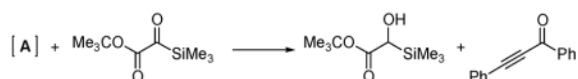

However, neither side product was observed when the title reaction reaction was run using the conditions described in eq 1, further supporting our mechanistic interpretations.

15. Only two examples of enantioenriched glycolate aldolates of this type have been prepared, to our knowledge. One was by a chiral auxiliary method: Murata Y, Kamino T, Hosokawa S, Kobayashi S. *Tetrahedron Lett* 2002;43:8121. The other was prepared by a direct catalytic method involving chiral zinc complexes: Kumagai N, Matsunaga S, Kinoshita T, Harada S, Okada S, Sakamoto S, Yamaguchi K, Shibasaki M. *J Am Chem Soc* 2003;125:2169. [PubMed: 12590545]
16. Carreira EM, Du Bois J. *J Am Chem Soc* 1995;117:8106.
17. Trost BM, Probst GD, Schoop A. *J Am Chem Soc* 1998;120:9228.

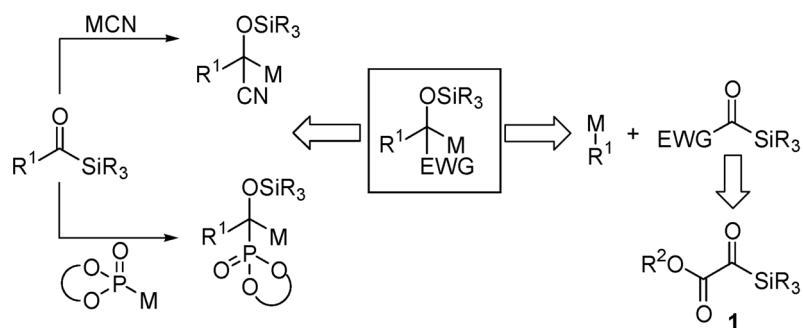

Scheme 1.

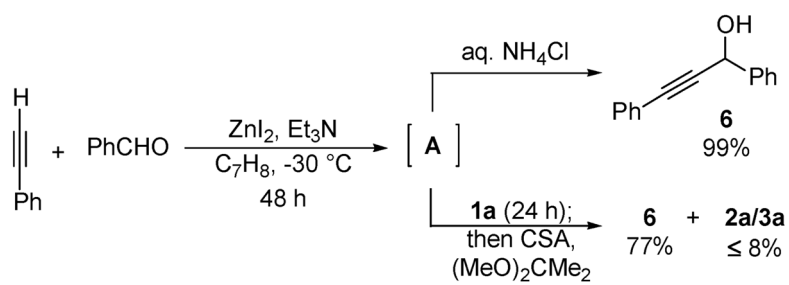

Scheme 2.
Mechanistic Study

Table 1

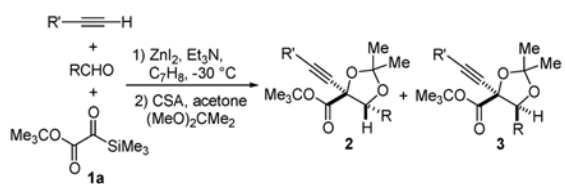
Reaction Scope with **1a**^a

(1)

entry	R'	R	yield (%) ^b	2:3 ^c
1	Ph	Ph	77	78:22
2	<i>n</i> -C ₆ H ₁₃	Ph	77	74:26
3	BnOCH ₂	Ph	60	72:28
4	PhthNCH ₂	Ph	48	71:29
5	Me ₃ Si	Ph	81	76:24
6	Me ₃ Si	2-(Me)C ₆ H ₄	65	80:20
7	Me ₃ Si	4-(MeO)C ₆ H ₄	73	80:20
8	Me ₃ Si	4-(Cl)C ₆ H ₄	76	78:22
9	Me ₃ Si	2-furyl	66	47:53
10	Me ₃ Si	(<i>E</i>)-PhCHd=CH	77	53:47

^aReaction carried out using 1.0 equiv of **1a**, 3.0 equiv of alkyne, 1.5 equiv of PhCHO, 3.0 equiv of ZnI_2 , and 3.3 equiv of Et_3N for 24–48 h.

^bAverage of two isolated yields. All reported yields are for two steps.

^cDetermined by ¹H NMR analysis of the crude reaction. See Supporting Information for determination of relative stereochemistry.

Table 2

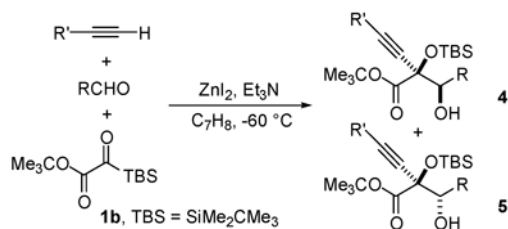
Reaction Scope with **1b**^a

(2)

entry	R'	R	yield (%)	4:5 ^b
1	Ph	Ph	73	83:17
2	<i>n</i> -C ₆ H ₁₃	Ph	73 (53)	90:10 (>99:1)
3	Me ₃ Si	2-(Me)C ₆ H ₄	70 ^c	91:9
4	<i>n</i> -C ₆ H ₁₃	4-(MeO)C ₆ H ₄	72 ^c	90:10
5	<i>n</i> -C ₆ H ₁₃	2-(Me)C ₆ H ₄	68 ^c	92:8

^a 1.0 equiv of **1b**, 4.0 equiv of alkyne, 1.5 equiv of PhCHO, 4.0 equiv of ZnI₂, and 4.4 equiv of Et₃N for 48 h.

^b Determined by ¹H NMR analysis of the crude reaction.

^c 5.0 equiv of alkyne, 5.0 equiv of ZnI₂, and 5.5 equiv of NEt₃ used. Parenthetical yield and dr refers to the diol, revealed after TBAF deprotection and recrystallization (two-step yield).