

# Frequency Dependence of Flow Resistance in Patients with Obstructive Lung Disease

GUNNAR GRIMBY, TAMOTSU TAKISHIMA, WILLIAM GRAHAM, PETER MACKLEM, and  
JERE MEAD

*From the Department of Physiology, School of Public Health, Harvard University, and the Thoracic Services, Boston University Medical School, Boston, Massachusetts 02115*

**ABSTRACT** Total respiratory, pulmonary, and chest wall flow resistances were determined by means of forced pressure and flow oscillations (3–9 cps) superimposed upon spontaneous breathing in a group of patients with varying degrees of obstructive lung disease. Increased total respiratory and pulmonary resistances were found, whereas the chest wall resistance was normal or subnormal. The total respiratory and pulmonary resistances decreased with increasing frequencies. Static compliance of the lung was measured during interrupted slow expiration, and dynamic compliance was measured during quiet and rapid spontaneous breathing. Compliance was found to be frequency-dependent. The frequency dependence of resistance and compliance are interpreted as effects of uneven distribution of the mechanical properties in the lungs. The practical application of the oscillatory technique to the measurement of flow resistance in patients with lung disease is discussed. Measurements of total respiratory resistance by the forced oscillatory technique at frequencies less than 5 cps appear to be as useful for assessing abnormalities in airway resistance as either the plethysmographic or esophageal pressure techniques.

## INTRODUCTION

DuBois, Brody, Lewis, and Burgess (1) were the first to study the response characteristics of the

Dr. Grimby's present address is Department of Clinical Physiology, Sahlgrenska Sjukhuset, University of Göteborg, Göteborg, Sweden.

*Received for publication 1 November 1967 and in revised form 9 February 1968.*

respiratory system. They applied sinusoidal pressures to subjects (who suspended their own efforts to breathe) and demonstrated that the human respiratory system has a resonant frequency at about 6 cps. Since, at such a frequency, mechanical impedance is entirely flow-resistive, the ratio of pressure to flow amplitude could be used to measure the flow resistance of the respiratory system. Mead (2) showed that this measurement could be made during breathing by superimposing the forced oscillations on the breathing pattern. Since only minimal cooperation is required, this approach is attractive for use in detecting abnormalities of flow resistance. But, does a measurement made at a frequency an order of magnitude higher apply to the conditions of ordinary breathing? In particular, does it apply in abnormal lungs? Patients with chronic obstructive disease show marked frequency dependence of pulmonary compliance (3), and, according to the theories advanced by Otis, McKerrow, Bartlett, Mead, McIlroy, Selverstone, and Radford (4), these patients should also be expected to show frequency dependence of flow resistance.

To answer these questions, we measured the frequency dependence of flow resistance in a group of patients with different degrees of obstructive lung disease. We measured pulmonary flow resistance during spontaneous breathing by means of esophageal balloons, and we measured pulmonary, chest wall, and total respiratory flow resistance during forced oscillations at 3, 5, 7, and 9 cps. In addition, we made separate measurements of airway resistance during voluntary panting at a fre-

quency of about 2 cps by the plethysmographic techniques of DuBois, Botelho, and Comroe (5).

To make measurements at frequencies other than the resonant frequency of the respiratory system, we use the following general approach. We display the applied pressure and resulting flow on the  $x$  and  $y$  axes of an oscilloscope. Increasing flows in the inspiratory direction produce upward deflections (and vice versa) from a zero-flow midpoint. Increasing pressures relative to atmospheric pressures produce deflections to the right (and vice versa) from a zero-pressure midpoint. When pressures are applied at frequencies below the resonant frequency of the respiratory system, pressure-flow loops are formed which develop in the clockwise direction. When frequencies are above the resonant frequency, pressure-flow loops are formed in the anticlockwise direction. As one passes from very low frequencies upward, the clockwise looping narrows and disappears, as the resonant frequency is approached, to be replaced by anticlockwise looping as the resonant frequency becomes exceeded. The looping reflects phase differences between pressure and flow. For clockwise looping, pressure lags behind flow. For anticlockwise looping, pressure leads flow. These phase differences result from the combined influences of the elastic and inertial properties of the respiratory system. At low frequencies the elastic properties dominate. Elastic pressures rise during inspiration to maximally positive values at end inspiration; as a result, pressure lags flow, and clockwise looping results. At frequencies above resonance, inertial properties dominate. Inertial pressures rise at the mouth, relative to atmospheric pressures, to maximum values at the end of expiration when the inspiratory acceleration is greatest, and as a result, pressure leads flow. At the resonant frequency the lag of pressure due to elastic properties is exactly counterbalanced by the lead as a result of inertial properties; flow and pressure are in phase, and all pressure-flow looping disappears.

But the phase differences as reflected by the looping of the pressure-flow pattern can also be changed without altering frequency. For example, if one subtracts from the pressure signal another signal which varies with volume, at frequencies below resonance the clockwise looping will be diminished. Indeed, at some fixed frequency below resonance, if just the right amount of volume sig-

nal is subtracted from the pressure signal, the loop can be caused to disappear. Alternatively, if one subtracts from the pressure signal one proportional to volume acceleration, at frequencies above resonance the looping will be diminished. Again, if, at a fixed frequency above resonance, just the right amount of this signal is subtracted, the looping can be made to disappear.

The explanation of this behavior is that by subtracting these signals from the pressure signal, one in effect simulates changes in the properties of the respiratory system: the elastic component of pressure developed by the respiratory system is directly proportional to volume change, whereas the inertial component is directly proportional to volume acceleration. Subtracting from the applied pressure a signal proportional to volume is like subtracting elasticity from the respiratory system, whereas subtracting signals proportional to volume acceleration is like subtracting inertia from the system. An important feature from the present standpoint is that neither subtraction in any way influences the flow resistance of the system. To establish the inphase, pressure-flow relationship, which defines the flow resistance of the respiratory system at frequencies other than resonant frequency, we achieve resonant behavior by simulating changes in the elastic or inertial properties of the respiratory system which reduce pressure-flow looping to a minimum and thereby achieve a simulated resonance.

Details of this approach are presented in the next section. At this point it should be mentioned that whereas in normal subjects resonant frequencies are usually found in the range of 5–7 cps, in patients with chronic obstructive disease commonly no resonant frequencies are demonstrable, at least up to frequencies of 10 cps. This is not surprising, since the elastic behavior of the lungs of such patients tends itself to be frequency-dependent (4). Reductions in dynamic compliance with increasing frequency imply increases in resonant frequency as well. Apparently, as the frequency is increased in these patients, resonant frequency remains above applied frequencies. In order to measure flow resistance by the method of forced oscillations in these patients, it was necessary to use our method for simulating resonance at all of the frequencies used.

TABLE I  
Physical Characteristics and Clinical Diagnosis of the Patients

Patient	Sex	Age	Height	Weight	Diagnosis
		<i>yr</i>	<i>cm</i>	<i>kg</i>	
Cl	M	20	186	75	Bronchial asthma
Jo	M	21	173	77	Bronchial asthma
Bac	F	16	173	64	Postpneumonia, cysts
Cr	M	58	180	77	Chronic obstructive lung disease
Wa	M	52	178	100	Bronchial asthma
Gi	M	41	185	62	Chronic obstructive lung disease, pneumonectomy, left
Bar	M	58	173	87	Chronic obstructive lung disease
Mc	M	42	170	60	Chronic obstructive lung disease
Con	M	48	186	76	Chronic obstructive lung disease
San	M	74	173	52	Chronic obstructive lung disease
Hug	M	58	168	66	Chronic obstructive lung disease
Hun	M	61	173	87	Chronic obstructive lung disease
Fa	M	63	180	76	Chronic obstructive lung disease
Col	M	77	168	66	Chronic obstructive lung disease, lobectomy, right upper
Du	M	49	170	73	Chronic obstructive lung disease

## METHODS

15 patients with obstructive lung disease, of whom one was a female, were studied. The diagnosis, age, body weight, and body height are given in Table I. The patients are ranked according to the degree of abnormality of their maximum expiratory flow-volume curve, as judged by the eye, starting with those with the most normal curves.

All measurements, except airway resistance, were made with the patients seated in a volume-displacement plethysmograph (J. H. Emerson Co., Cambridge, Mass.) which differed in two respects from the one described by Mead (6). (a) The temperature within the box was regulated with an air-cooling system. Heat exchange between air in the box and the coolant from a 0.25 horsepower compressor was accomplished within a 6.5 cm, diameter, 120 cm long copper pipe attached to the outside wall of the box. Air from the box was moved through the pipe and back into the box by means of a motor-driven blower, while coolant moved in the opposite direction through a central coaxial copper tube, feathered to increase the surface for heat exchanges. (b) The response characteristics of the plethysmograph were improved by mixing a signal proportional to box pressure with the spirometer output. Such a pressure-volume plethysmograph combines useful features of pressure plethysmography (speed of response) with those of volume plethysmography (relatively small size and light weight construction, plus extended range of measurement). In practice proper mixing of the signals was accomplished by comparing flow into the box, as measured with the Fleisch flowmeter, with the derivative of the mixed signal. The relative gains were adjusted so as to minimize phase and amplitude differ-

ences. Over the range from 0 to 9 cps, the phase difference and relative amplitude could be rendered negligible.

Rapid oscillations of flow at the mouth were produced with a loudspeaker system driven by a low frequency sine-wave generator and power amplifier. Measurements were made during quiet breathing at frequencies of 3, 5, 7, and 9 cps. The pressure generator is schematically shown in Fig. 1a together with the equivalent electrical circuit of the system. Fig. 1b shows a photograph of the equipment.

The design of the pressure generator was directed toward these ends: (a) to apply at a given setting of the sine-wave generator a pressure variation at the airway opening which is, as nearly as possible, independent of changes in mechanical impedance offered by the subject. (b) to offer as little impedance to breathing as possible. (c) to avoid rebreathing of expired air. The last is accomplished by withdrawing air at a constant rate of 0.4 liter/sec through a side tap at the mouthpiece. The resulting shift in the flowmeter signal is suppressed electrically. The impedance to breathing is minimized by using a low-resistance flow meter (Fleisch Model No. 4, 1 mm of H<sub>2</sub>O at 1.49 liters/sec) and a low-resistance exit from the box (the 170 cm long, 5 cm, i.d., tube connecting the inside of the box to the atmosphere). The pressure variation at the mouth associated with spontaneous breathing is less than 6 mm of H<sub>2</sub>O. The first point is a convenience rather than a necessity. To the extent that the applied pressure can be held constant, the flow amplitude varies inversely with flow resistance (at the resonant frequency). This simplifies measurement. For the measurements reported in this study, this feature is not used. It is achieved (to a close approximation) by using a flowmeter of the lowest practical resistance so as to re-

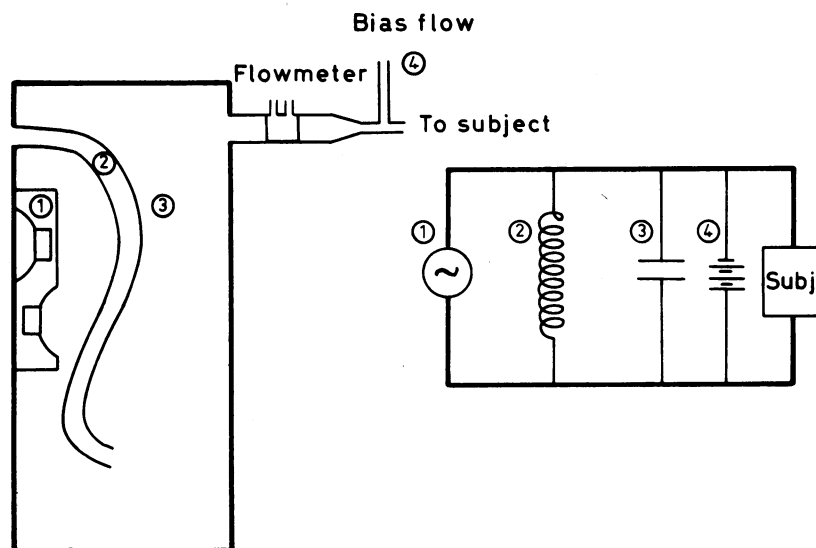

FIGURE 1a Schematic drawing of the loudspeaker system and the equivalent electrical circuit. 1, Two Acoustic Research (Cambridge, Mass.) Model No. 1 loudspeakers are arranged mechanically in series, as shown. The polarity of applied voltage is such that the speaker displacement is in the same direction; 2, tubing from the atmosphere to the box. It gives high inertial impedance at high frequencies (for the oscillations) and low inertial impedance at low frequencies (quiet breathing); 3, volume of gas in the box; 4, bias flow to reduce the dead space.

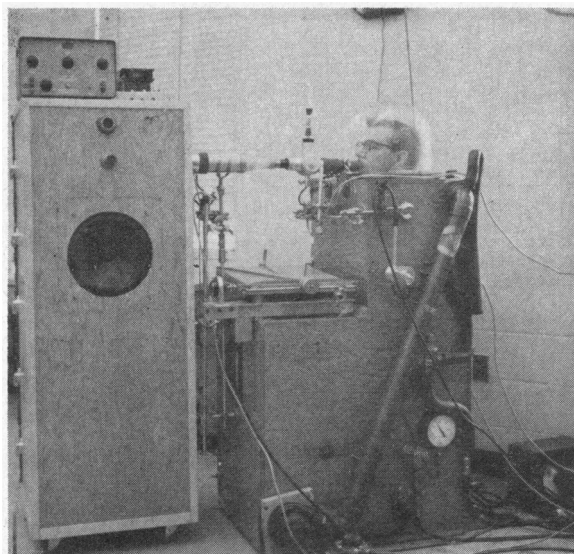

FIGURE 1b Photograph of the loudspeaker box, the temperature regulated body plethysmograph, and the bias-flow system.

duce pressure losses between the generator and the subject, and by rendering the loading of the loudspeakers nearly constant. This load consists of the impedance of the tube, of the compressible gas within the box, and of the experimental subject, all three operating together. The impedance of a parallel network is relatively insen-

sitive to changes of impedance in one of its branches so long as the impedance of that branch is high compared to that of the others. The 130 liters of gas within the box is a low impedance compared to that of the respiratory system and, accordingly, the loading of the loudspeaker is quite insensitive to changes in impedance of the respiratory system.

The electrical equivalent of the respiratory system is shown in Fig. 2 together with the equations for calculating the resistance of the different compartments. The air flow at the mouth ( $V_{s,o}$ ) was measured with the Fleisch flowmeter and a Sanborn transducer (No. P270) and used for calculating the total respiratory ( $R_{r,s}$ ) and pulmonary resistance ( $R_l$ ). To calculate the chest wall resistance ( $R_w$ ), the volume recording from the plethysmograph was differentiated ( $\dot{V}_w$ ).

Esophageal pressure, as an index of pleural pressure ( $P_{p1}$ ), was measured with a 10 cm rubber balloon containing 0.2–0.5 ml of air (8). The transpulmonary pressure (mouth pressure minus esophageal pressure) and the transrespiratory pressure (mouth pressure minus pressure in the plethysmograph) were measured with inductance manometers (Sanborn Co., Waltham, Mass., No. 268-B). All volumes, flows, and pressures were recorded on a 6-channel tape recorder (Precision Instrument Co., Palo Alto, Calif.).

Flow and pressure signals from the tape recorder were combined after the experiments on an X-Y cathode-ray storage oscilloscope (Tektronix Model 564, with two type 3A72 plug-in amplifiers, Portland, Oreg.), and corrections were made to obtain flow-resistive pres-

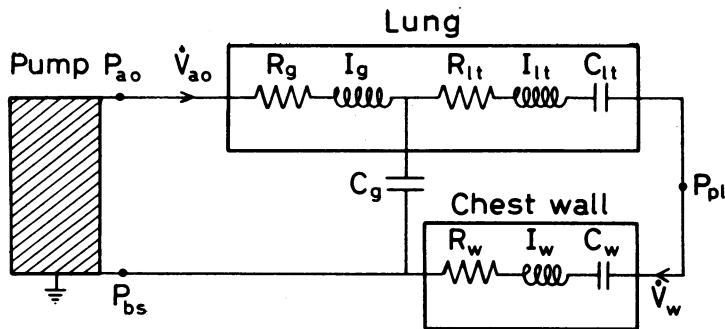

At resonant frequency or with electrical correction for reactance:

$$R_{rs} = \frac{P_{ao} - P_{bs}}{\dot{V}_{ao}}$$

$$R_l = \frac{P_{ao} - P_{pl}}{\dot{V}_{ao}}$$

$$R_w = \frac{P_{pl} - P_{bs}}{\dot{V}_w}$$

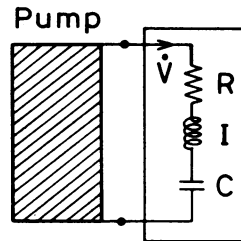

FIGURE 2 Equivalent electrical circuit for the respiratory system. For symbols see Mead and Milic-Emili (7).

sure by adding or subtracting signals proportional to volume and (or) volume acceleration in the manner described in the Introduction. An example of an uncorrected and a corrected recording is shown in Fig. 3. Since, in general, the corrections were different for the lungs, chest wall, and total respiratory system, the tape recording facility was essential. Corrections made at the time would have required intolerably long experiments. Photographs of flow versus pressure were measured to yield the flow resistance for the total respiratory system ( $R_{rs}$ ), for the airways plus the lung tissue ( $R_l$ ), and for the chest wall ( $R_w$ ). Simultaneous recordings on a direct-writing Sanborn Recorder were also obtained. The resistance was measured as the inverse of the slope of flow-pressure tracing at about 0.5 liter/sec of inspiratory air flow, which usually approximated the maximal inspiratory flow rate. It was not possible to estimate slopes at lower flows because the flow rate on which the oscillations were superimposed changed too rapidly between the respiratory phases (see Figs. 3 and 4).

Pulmonary resistance (resistance of airways plus lung tissue) was also measured during quiet and rapid breathing, with the electrical subtraction of a signal proportional to volume in order to correct for lung elastic pressure. The proportionality constant was set on the X-Y oscilloscope and the line, usually S-shaped with or without a loop in the expiratory phase, was photographed. The resistance was calculated as the pressure-flow ratio from 0.5 liter/sec inspiratory flow to zero flow. The nonlinear pressure-flow relationship was also used for calculating the constants in Rohrer's expression ( $P = K_1\dot{V} + K_2\dot{V}^2$ , in which  $P$  is pressure in cm of  $H_2O$ , and  $\dot{V}$  is flow in liters/sec) in a similar way to that used by Mead and

Whittenberger (9). These constants were then used to calculate the slope of the pressure-flow relationship at a flow of 0.5 liter/sec in order to obtain a value during quiet breathing which could be compared with the one obtained during forced oscillations.<sup>1</sup>

The total lung capacity was measured plethysmographically by the method of DuBois, Botelho, Bedell, Marshall, and Comroe (10). Dynamic compliance was estimated from the end-inspiratory and expiratory pressures at zero-flow points and the volume change. About 1-2 hr before the oscillatory measurements were made, airway resistance was measured in a pressure plethysmograph by the method of DuBois et al. (5) at a panting frequency of approximately 2 cps. At this time the forced expiratory volume in 1 sec ( $FEV_{1.0}$ ) was determined with a Collins spirometer, and the maximum voluntary ventilation (MVV) with a spontaneous frequency was measured with a Douglas bag in an open system. The normal values for total lung capacity and vital capacity were predicted according to Baldwin, Cournand, and Richards (11), and for  $FEV_{1.0}$  and MVV according to Kory, Callahan, Boren, and Syner (12).

## RESULTS

The results of the spirometric studies are given in Table II.

<sup>1</sup> The slope of the pressure-flow relationship,  $dP/d\dot{V}$ , at a flow of 0.5 liter/sec was calculated from Rohrer's expression as follows:  $P = K_1\dot{V} + K_2\dot{V}^2$ ;  $dP/d\dot{V} = K_1 + 2K_2\dot{V}$ ; at  $\dot{V} = 0.5$  liter/sec  $dP/d\dot{V} = K_1 + 2K_2(0.5) = K_1 + K_2$ .

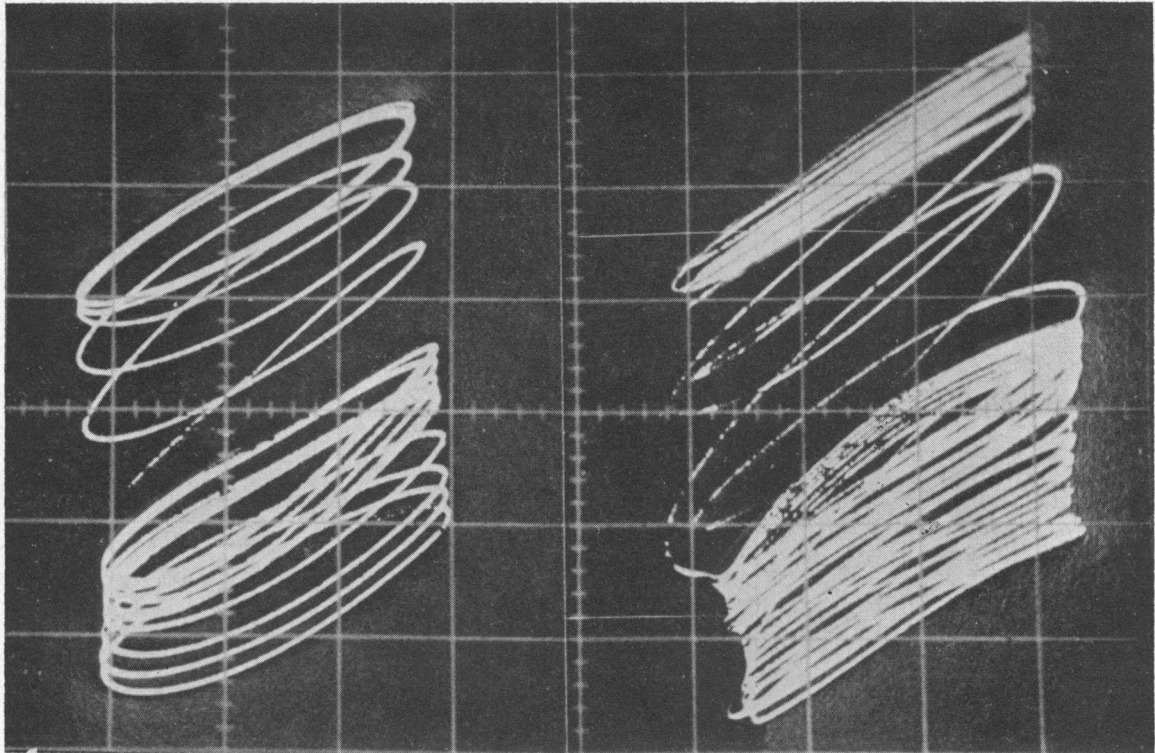

FIGURE 3 Pressure-flow relationship during oscillations at 9 cps of the total respiratory system. Horizontal axis, mouth pressure minus pressure in the body plethysmograph, 1 subdivision = 1 cm of H<sub>2</sub>O; vertical axis; mouth flow 1 subdivision = 0.25 liter/sec. Zero flow is indicated on the horizontal line in the middle with inspiratory direction towards the top of the figure. The left part of the figure shows recording before correction for the reactance; the right part shows the same pressure-flow relationship after electrical correction.

TABLE II  
Spirometric Data

Patient	Total lung capacity		Vital capacity		RV/TLC	FEV <sub>1.0</sub>		MVV	
	liters	% predicted	liters	% predicted	%	liters	% predicted	liters/min	% predicted
Cl	6.70	113	5.20	110	22	3.70	79	112	56
Jo	6.50	119	5.20	119	20	3.60	85	158	85
Bac	4.70	108	2.80	80	40	2.40	75	95	—
Cr	7.10	129	3.70	97	48	2.25	66	92	64
Wa	6.60	118	2.90	75	56	1.47	41	—	—
Gi	5.50	100	2.60	61	53	1.35	37	32	19
Bar	6.70	127	2.70	74	60	1.20	36	35	26
Mc	6.00	118	3.00	77	50	1.95	56	63	41
Con	8.10	150	2.50	60	69	1.70	44	46	28
San	10.00	207	3.20	96	68	1.50	56	29	25
Hug	6.90	135	3.30	93	52	1.45	49	32	25
Hun	6.90	133	2.70	75	61	1.30	36	28	21
Fa	10.70	200	3.70	100	65	1.15	35	32	23
Col	5.90	128	2.50	78	58	1.65	67	49	47
Du	8.15	166	3.10	82	62	1.95	59	18	13

RV/TLC, quotient between residual volume (RV) and total lung capacity (TLC); FEV<sub>1.0</sub>, forced expiratory volume in 1 sec; MVV, maximum voluntary ventilation.

**TABLE III**  
*Pulmonary Resistance,  $K_1$  and  $K_2$  in Rohrer's Expression, and Dynamic Compliance during Quiet Breathing, Static Compliance, and Airway Resistance*

Patient	Quiet breathing						
	f	$R_1$	$K_1$	$K_2$	$C_{dyn}(1)$	$C_{st}$	$R_{aw}$
	<i>cps</i>	<i>cm H<sub>2</sub>O/ liters per sec</i>			<i>liters/cm H<sub>2</sub>O</i>	<i>liters/cm H<sub>2</sub>O</i>	<i>cm H<sub>2</sub>O/liters per sec</i>
Cl	0.40	4.7	2.2	3.2	0.13	0.17	4.2
Jo	0.25	5.0	2.9	4.2	0.16	0.26	4.7
Bac	0.40	2.0	2.0	0.8	0.07	0.15	3.8
Cr	0.34	2.4	2.3	0.7	0.32	0.55	2.3
Wa	0.30	8.5	7.8	4.8	0.11	0.25	—
Gi	0.17	8.5	5.0	2.4	0.07	0.25	7.2
Bar	0.47	5.6	5.4	2.7	0.11	0.35	5.2
Mc	0.38	6.5	6.4	2.2	0.12	0.25	4.5
Con	0.35	8.3	5.0	5.2	0.05	—	4.6
San	0.44	6.7	5.0	2.0	0.12	0.39	4.0
Hug	0.30	14.0	7.4	10.8	0.13	0.42	5.6
Hun	0.41	8.0	3.7	8.0	0.10	0.28	4.0
Fa	0.36	6.0	5.6	3.6	0.11	0.48	4.3
Col	0.40	8.4	7.4	2.2	0.04	0.19	4.9
Du	0.40	—	—	—	0.08	0.23	4.5

f, respiratory frequency;  $R_1$ , pulmonary resistance;  $C_{dyn}$ , dynamic compliance;  $C_{st}$ , static compliance;  $R_{aw}$ , airway resistance.

Table III gives pulmonary resistance (calculated as the slope between zero flow and 0.5 liter/sec inspiratory flow),  $K_1$ - $K_2$  of Rohrer's expression, and dynamic compliance, all during quiet breathing, as well as static compliance and airway resistance, determined according to DuBois et al. (5).

An example of the oscillographic recordings for

measurements of total respiratory resistance at different frequencies is given in Fig. 4. Patient Mc had a definite increase in resistance compared with the normal range and a moderate frequency dependence of the resistance.

Fig. 5 presents the results of the measurements of the total respiratory resistance in all patients. The resistance was lower in all patients at 9 cps

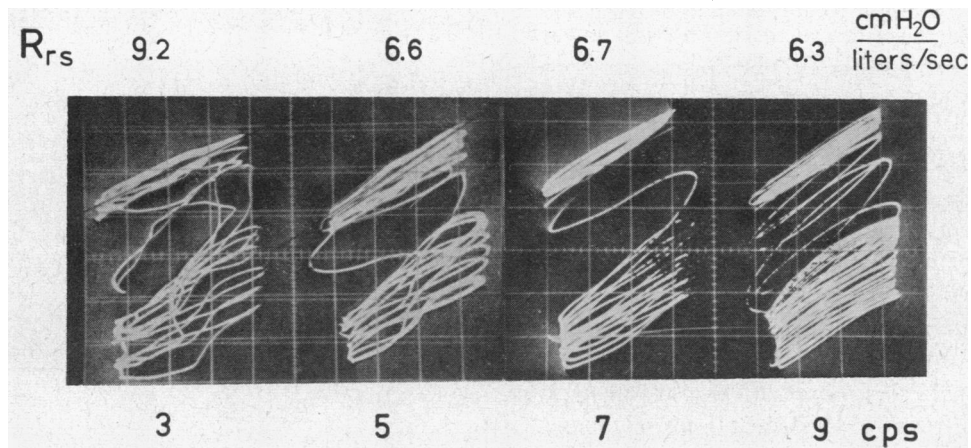

**FIGURE 4** Relationship between resistive pressure and flow for the total respiratory system at oscillations of 3, 5, 7, and 9 cps in patient Mc. Horizontal axis, resistive pressure, 1 subdivision = 1 cm of H<sub>2</sub>O; vertical axis; mouth flow, 1 subdivision = 0.25 liter/sec. The total respiratory resistance for each frequency is given.

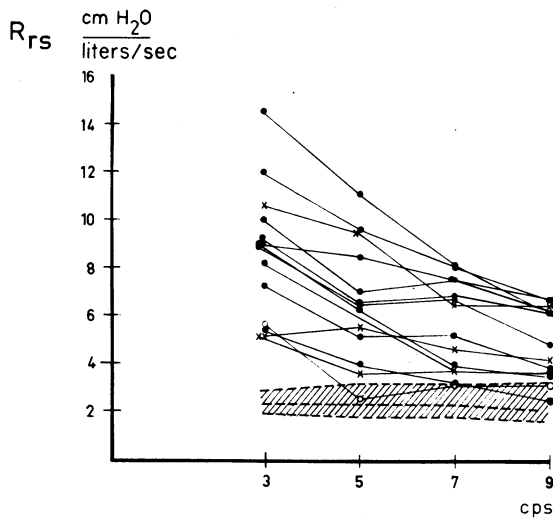

FIGURE 5 Total respiratory resistance at different frequencies. ●, chronic obstructive disease; ×, bronchial asthma; ○, postpneumonia. The shaded area indicates the range for a group of five normal subjects (Wohl et al., unpublished observations). The line in the middle connects the mean values for the normal subject.

than at 3 cps. There was individual variation in the frequency dependence of the resistance; those with the highest resistance at 3 cps showed the most pronounced fall in resistance with increasing frequencies. The mean values and range from a group of five normal subjects in the age 22–45 yr, who recently have been studied in this laboratory with similar techniques (Wohl, M. E., P. Gross, and J. Mead, unpublished observations), are also shown in the figure. All values from the patients at 3 cps fell above the normal range, and a five- to eightfold increase in the resistance was observed.

Fig. 6 demonstrates the pulmonary (airway plus lung tissue) resistance at different oscillatory frequencies. In addition to this, the resistance during quiet breathing, calculated as the tangent to the pressure-flow relationship at 0.5 liter/sec, is given. As in the previous figure, a fall in resistance with increasing frequency was found. It occurred in most patients over the whole frequency range, but usually with a less marked fall between the highest frequencies. The range for a normal group (Wohl et al., unpublished observations) are also given. All values from the patients at 3 cps fell above the normal range. At higher frequencies patient Bac had values within the normal range.

Fig. 7 shows the results of the measurements of chest wall flow resistance. The trans-chest wall

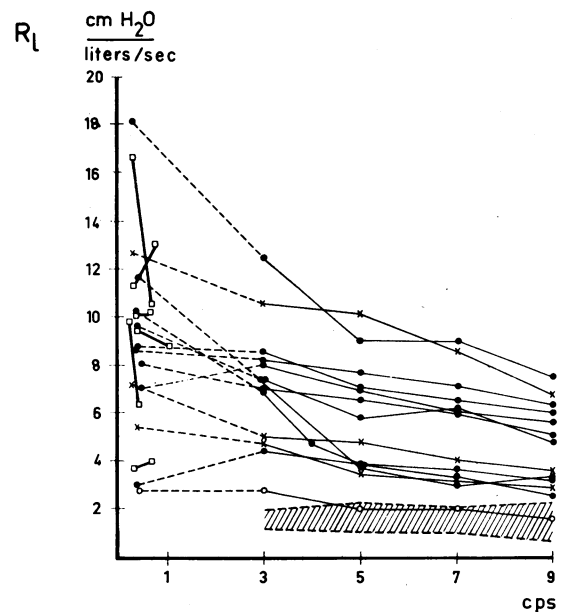

FIGURE 6 Pulmonary resistance at different frequencies. ●, chronic obstructive disease; ×, bronchial asthma; ○, postpneumonia. The tangent to the pressure-flow curve during quiet breathing at a flow of 0.5 liter/sec is given in the left part of the figure. For explanation see Results. The shaded area indicates the range for a group of five normal subjects (Wohl et al., unpublished observations). Values from the report of Channin and Tyler ([16] see Discussion) are shown by open squares.

pressure oscillations were in most patients only a minor fraction of the forced oscillations at the mouth. The relatively small pressure variations decreased the accuracy of the measurement, and the value for the resistance could in some patients not be distinguished from zero. No significant decrease

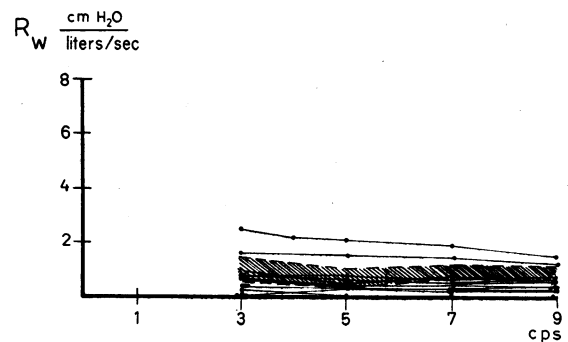

FIGURE 7 Chest wall resistance at different frequencies. ●, chronic obstructive disease; ×, bronchial asthma; ○, postpneumonia. The shaded area indicates the range for a group of five normal subjects (Wohl et al., unpublished observations).



with increasing frequency was found. Most values fell in or even below the normal range (Wohl et al., unpublished observations). The mean values for all patients were 0.6 (range 0–2.5), 0.5 (range 0–2.3), 0.5 (range 0–1.9), and 0.4 (range 0–1.5) cm of H<sub>2</sub>O per liters per sec for 3, 5, 7, and 9 cps, respectively.

The chest wall resistance comprised only a minor fraction of the total respiratory resistance in most of the patients. The values for pulmonary and total respiratory resistance were therefore fairly close at all frequencies, as can be seen in Fig. 8.

Airway resistances, measured separately in a pressure plethysmograph, were based on the best linear approximation made by the eye to the flow-pressure relationship during inspiration in the neighborhood of zero flow. For comparison we used values of  $K_1$ , which defines flow resistance at zero flow, as estimated graphically for spontaneous breathing and as calculated for forced oscillations. The calculation was based on the assumption that the ratio of Rohrer's constants,  $K_1/K_2$ , is the same during forced oscillations as during spontaneous breathing. The comparison is presented in Fig. 9. The airway resistance was measured at fre-

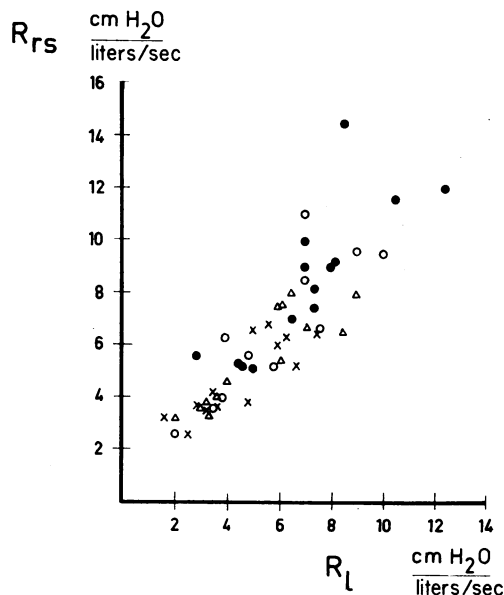

FIGURE 8 The relationship between total respiratory and pulmonary resistance, measured with the oscillatory technique in the patients. ●, 3 cps; ○, 5 cps; △, 7 cps; ×, 9 cps.

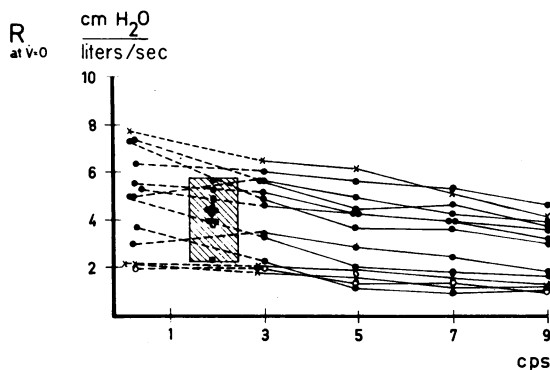

FIGURE 9 Pulmonary resistance at zero flow calculated from the oscillatory measurements. ●, chronic obstructive disease; ×, bronchial asthma; ○, postpneumonia. For explanation see Results. Similar values for quiet breathing are given to the left. The shaded area describes the range for the airway resistance measured according to DuBois et al. (5), with the individual values indicated.

quencies estimated to range from 1.5 to 2.5 cps. The range and individual values for airway resistance are indicated within the shaded area. Although the individual variation is strikingly less, the general level of resistance interpolates reasonably well between the values for pulmonary resistance at lower and higher frequencies.

## DISCUSSION

The results are interesting both practically and theoretically. From a practical viewpoint the method of forced oscillations, even applied only to measure total respiratory resistance, appears to be as good a method as either the plethysmographic or esophageal pressure techniques for estimating resistance to breathing. This is true because the resistance of the chest wall, if anything, tends to be reduced in chronic obstructive lung disease and is small compared to pulmonary flow resistance, and because the frequency dependence of resistance, although demonstrable in many instances, is generally small in the range from spontaneous breathing through 5 cps (see Figs. 6 and 9).

An essential feature of the method of forced oscillations as applied to patients in contrast to normal subjects is the requirement of electrical tuning to establish resonance at the lowest frequency practical, thereby minimizing reductions in resistance from frequency sensitivity. Measurements below about 3 cps are impractical because of mounting difficulty in distinguishing forced

oscillations in flow from the spontaneous flow pattern on which they are superimposed. Tuning in the neighborhood of 3–5 cps appears to offer the best compromise between this unfavorable signal-to-noise ratio at low frequencies and the drop in resistance at high frequencies.

The equipment required for such a measurement could be far simpler than that used in our study. The electrical tuning can be accomplished at the time of the measurement, and thus no tape recorder is necessary. The source of oscillating pressure need not require a large chamber or two loudspeakers. We designed our pressure source for additional uses which required these features. A single loudspeaker connected directly to the flowmeter parallel with a long tube (such as tube 2 in Fig. 1 a) and incorporating a bias-flow system (tube 4, Fig. 1 a) produces adequate pressure oscillations. The body plethysmograph, although a convenient device for measuring an important adjunct to the measurement, namely lung gas volume, is not needed for measurements of either total respiratory resistance or pulmonary resistance per se.

Brody, O'Halloran, Wander, Connolly, Roley, Kohold, and Swertley (13, 14) have given normal values for total respiratory resistance obtained during forced oscillations at 10 cps. Our results suggest that values obtained in patients at such a frequency would not differ from normal values in some instances

We chose to calculate the resistances during inspiration, in which the pressure-flow relationship is fairly consistent. During expiration large and sudden variations in resistance occur. These are found commonly even in normal subjects, and appear to be due to changes in the cross-sectional area in the upper airway, presumably in the larynx (15). In patients with chronic obstructive disease, changes in resistance during expiration invariably occur and reflect dynamic compression of intrathoracic airways. There is, however, in the present study, a high degree of nonlinearity as demonstrated by the large values of  $K_2$  in Rohrer's expression (see Table III). This makes the resistance measurements very sensitive to the flow range over which they are measured, e.g., compare Figs. 6 and 9. In normal lungs  $K_2$  for intrathoracic airways is probably not more than 0.1 (see reference 15). If  $K_2$  in the upper airways of patients is

assumed to be normal, i.e. about 0.3, this means that  $K_2$  of intrathoracic airways is increased at least 10 times.

From a theoretical point of view, our results are of interest since they confirm a prediction made by Otis et al. (4), namely, that patients who exhibit frequency dependence of compliance should also exhibit frequency dependence of resistance. These authors consider the implications of non-uniform distribution of mechanical properties of lungs to their over-all mechanical behavior. The finding in patients with chronic obstructive pulmonary disease that compliance drops as frequency increases, according to their theories, reflects discrepancies in time constants between different parts of the lung. (The time constant of a region is the product of the flow resistance of all airways supplying the region and the compliance of the region.) They show that inequality of time constants would also lead to frequency dependence of flow resistance.

In apparent contradiction to the prediction of Otis et al. (4), Channin and Tyler (16) found that total pulmonary resistance fell substantially in only two of six patients each of whom had demonstrated a marked fall in dynamic compliance with frequency. Fig. 6 presents their results along with our own, and demonstrates that the frequency range encompassed by their experiments (the largest range practical during spontaneous breathing without shifting lung volume) was too small to detect frequency sensitivity of the order observed by us.

Although both compliance and resistance decrease with increasing frequency in chronic obstructive lung disease, it is not possible to compare these decreases because of the widely differing ranges of frequencies over which the reductions have been observed. The most striking reduction in compliance occurs between static values and spontaneous breathing, a range in which no resistance measurements are available and, indeed, in which measurements would be difficult to make. On the other hand, measurements of dynamic compliance at frequencies above approximately 2 cps are difficult to interpret due to the mounting and unknown contribution of inertial pressures. The frequency range over which both resistance and compliance can be measured is probably not much greater than that observed by Channin and Tyler

(Fig. 6) and is too restricted to permit adequate definition of their relative frequency sensitivity.

The total respiratory and the pulmonary resistance at low frequencies was in all patients increased compared with normal values. At most, the total respiratory resistance was increased 6-7-fold. At higher frequencies the differences were less, and in some patients, they were almost abolished. The frequency dependence of resistance in normal subjects (Wohl et al., unpublished observations) is of much smaller magnitude than that in most of the patients.

The chest wall resistance was, with two exceptions, either in the low-normal range or below the normal range. The subnormal values could, hypothetically, be explained as an effect of increased lung volumes. For example, it is reasonable to assume that pressure losses associated with tissue viscous resistances are proportional to linear velocities of tissues. Accordingly, since a given rate of volume change would be associated with a decrease in linear movements of tissues as the volume at which the volume change is produced is increased, the chest wall resistance in patients who breathe at increased lung volumes should be less than in normal individuals. For a doubling of lung volume, not an unreasonable value, one would anticipate a reduction in tissue resistance on this basis alone of approximately 37%. (This follows from our assumption that tissue resistance is proportional to tissue velocity and the further assumption of spherical geometry, such that the linear differential,  $dr = 1/4\pi r^2 \times dV$ , varies inversely with  $r^2$  and hence inversely with  $V^{2/3}$ ). The reductions in chest wall resistance appear to be consistent with this interpretation.

#### ACKNOWLEDGMENTS

We are indebted to Drs. E. A. Gaensler and H. Constantine for valuable assistance and cooperation in the selection of the patients and the determination of airway resistance.

This work was supported by U. S. Public Health Research Grant No. AP 00229 (Mechanical Factors in the Control of Breathing) and No. 6M 12564 (Studies in Respiratory Mechanics).

#### REFERENCES

1. DuBois, A. B., A. W. Brody, D. H. Lewis, and B. F. Burgess, Jr. 1956. Oscillation mechanics of lungs and chest in man. *J. Appl. Physiol.* 8: 587.
2. Mead, J. 1960. Control of respiratory frequency. *J. Appl. Physiol.* 15: 325.
3. Mead, J., I. Lindgren, and E. A. Gaensler. 1955. The mechanical properties of the lungs in emphysema. *J. Clin. Invest.* 34: 1005.
4. Otis, A. B., C. B. McKerrow, R. A. Bartlett, J. Mead, M. B. McIlroy, N. J. Selverstone, and E. P. Radford, Jr. 1956. Mechanical factors in distribution of pulmonary ventilation. *J. Appl. Physiol.* 8: 427.
5. DuBois, A. B., S. Y. Botelho, and J. H. Comroe, Jr. 1956. A new method for measuring airway resistance in man using a body plethysmograph: values in normal subjects and in patients with respiratory disease. *J. Clin. Invest.* 35: 327.
6. Mead, J. 1960. Volume displacement body plethysmograph for respiratory measurements in human subjects. *J. Appl. Physiol.* 15: 736.
7. Mead, J., and J. Milic-Emili. 1964. Theory and methodology in respiratory mechanics with glossary of symbols. In *Handbook of Physiology*. American Physiology Society, Washington, D. C. 1: 363.
8. Milic-Emili, J., J. Mead, J. M. Turner, and E. M. Glauser. 1964. Improved technique for estimating pleural pressure from esophageal balloons. *J. Appl. Physiol.* 19: 207.
9. Mead, J., and J. L. Whittenberger. 1953. Physical properties of human lungs measured during spontaneous respiration. *J. Appl. Physiol.* 5: 779.
10. DuBois, A. B., S. Y. Botelho, G. N. Bedell, R. Marshall, and J. H. Comroe, Jr. 1956. A rapid plethysmographic method for measuring thoracic gas volume: a comparison with a nitrogen washout method for measuring functional residual capacity in normal subjects. *J. Clin. Invest.* 35: 322.
11. Baldwin, E. de F., A. Courmand, and D. W. Richards, Jr. 1948. Pulmonary insufficiency. I. Physiological classification, clinical methods of analysis, standard values in normal subjects. *Medicine.* 27: 243.
12. Kory, R. C., R. Callahan, H. G. Boren, and J. C. Syner. 1961. The Veterans Administration-Army cooperative study of pulmonary function. I. Clinical spirometry in normal men. *Am. J. Med.* 30: 243.
13. Brody, A. W., P. S. O'Halloran, H. J. Wander, J. J. Connolly, Jr., E. E. Roley, and E. Kobold. 1960. Ventilatory mechanics and strength: long-term re-examinations and position change. *J. Appl. Physiol.* 15: 561.
14. Brody, A. W., H. J. Wander, P. O'Halloran, J. J. Connolly, Jr., and F. W. Schwertley. 1964. Correlations, normal standards and interdependence in tests of ventilatory strength and mechanics. *Am. Rev. Respirat. Diseases.* 89: 214.
15. Ferris, B. G., Jr., J. Mead, and L. H. Opie. 1964. Partitioning of respiratory flow resistance in man. *J. Appl. Physiol.* 19: 653.
16. Channin, E., and J. Tyler. 1962. Effect of increased breathing frequency on inspiratory resistance in emphysema. *J. Appl. Physiol.* 17: 605.