

## The Chemical Basis of Pharmacology<sup>†</sup>

Michael J. Keiser, John J. Irwin,\* and Brian K. Shoichet\*

*Department of Pharmaceutical Chemistry, University of California San Francisco, 1700 4th Street, Byers Hall, Room 508D, San Francisco, California 94158-2558, United States*

*Received September 21, 2010; Revised Manuscript Received November 5, 2010*

**ABSTRACT:** Molecular biology now dominates pharmacology so thoroughly that it is difficult to recall that only a generation ago the field was very different. To understand drug action today, we characterize the targets through which they act and new drug leads are discovered on the basis of target structure and function. Until the mid-1980s the information often flowed in reverse: investigators began with organic molecules and sought targets, relating receptors not by sequence or structure but by their ligands. Recently, investigators have returned to this chemical view of biology, bringing to it systematic and quantitative methods of relating targets by their ligands. This has allowed the discovery of new targets for established drugs, suggested the bases for their side effects, and predicted the molecular targets underlying phenotypic screens. The bases for these new methods, some of their successes and liabilities, and new opportunities for their use are described.

So dominant has the molecular biology view of pharmacology become that it is difficult to remember that even 25 years ago it was little more than an aspiration. Today we understand the activity of drugs and reagents first through the specific, clonable receptor molecules with which they interact. To understand biological mechanism we begin with a specific molecular receptor, and to discover new leads for pharmacological intervention, we screen a library of compounds against a particular isolated target. Even when we screen for a phenotype against a cell or organism we subsequently seek to isolate the receptor responsible for that phenotype. Two targets are similar when their sequences and structures are similar, and when we think about side effects our first thoughts are of those proteins that are most related by sequence and structure to the particular targets in which we are interested.

A generation ago this view was inverted: investigators more often began with small molecules and sought targets, and receptors were related not by sequence or structure but by their ligands (Figure 1). Except for some soluble enzymes, these receptors were rarely used in isolation. Most were characterized by the patterns of agonists and antagonists that modulated their activity, often in experiments conducted on entire organs such as the guinea pig ileum or atrium perfused in baths of reagent. Thus, Ahlquist first divided the adrenergic responding receptors into  $\alpha$  and  $\beta$  subclasses based on differing dose responses to norepinephrine, epinephrine, and isoproterenol in organ systems such as the uterus, the cat nictitating membrane, pupil dilation, and gut contraction, in 1948 (1). Twenty years later, Lands further divided the  $\beta$ -adrenergic family into  $\beta_1$  and  $\beta_2$  receptors based on differing specificities for these same agonists on fatty acid mobilization,

and bronchodilation and vasodepression, also in whole organs (2). The distinction between the  $\alpha$  and  $\beta$  adrenergic receptors was strengthened by the appearance of the first  $\beta$ -blockers, such as propranolol. Subtype selective agonists, such as salbutamol for  $\beta_2$ , and antagonists, such as atenolol for  $\beta_1$ , further solidified the classification of the  $\beta$ -AR family. Meanwhile, the  $\alpha$ -adrenergics were subdivided into  $\alpha_1$  and  $\alpha_2$  classes based on postsynaptic and presynaptic sites of action and the differing specificities of related antagonists. The histamine receptor family was subdivided into the H1 and H2 classes based on the ability to distinguish receptors that responded to histamine but not to mepyramine yet could be antagonized by Burimamide and molecules related to it, initially based on organ level experiments on guinea pig atrium and ilium (3). Gaddum first differentiated receptors responding to serotonin into two subtypes in the 1950s based on the contraction of smooth muscle or on the depolarization of the cholinergic nerves. These targets were subsequently classified in the 5-HT1, 5-HT2, and 5-HT3 families using specific and distinguishing agonism and especially antagonism by drugs like Bemestron and Tropicsetron (for the 5-HT3 family).

Classifying targets by small molecules often led directly to new therapeutics. Thus, the subdivision of the  $\beta$ -adrenergic family into the  $\beta_1$  and  $\beta_2$  subtypes both allowed and was itself confirmed by the development of the  $\beta$ -blockers and  $\beta_2$  agonists. Similarly, the specific antagonist Burimamide defined Black's elucidation of the histamine H2 family, and this led directly to the first histamine-acting anti-ulcer drug, Cimetidine, cited in Black's receipt of the Nobel Prize in Physiology or Medicine in 1988. ICS 205-930 not only was the molecule that defined 5-HT3 as a unique and specific receptor (4) but also became the anti-nausea drug Tropicsetron (Figure 2). The classification of receptors by small molecules remains with us to this day, and we still talk of the  $\alpha_1$ ,  $\alpha_2$ ,  $\beta_1$ ,  $\beta_2$ , H1, H2, and 5-HT1–3 receptors.

This antique chemical taxonomy leaves us with, from the molecular biology perspective, some odd bestiaries. All of the serotonin

<sup>†</sup>Research supported by National Institutes of Health Grants GM71896 (to J.J.I. and B.K.S.) and AGG002132 (to S. Prusiner and B.K.S.) and by the Rogers Family Foundation (to M.J.K., J.J.I., and B.K.S.).

\*To whom correspondence should be addressed. J.J.I.: e-mail, irwin@cgl.ucsf.edu; phone, (415) 514-4127; fax, (415) 514-4260. B.K.S.: e-mail, shoichet@cgl.ucsf.edu; phone, (415) 514-4126; fax, (415) 514-4260.

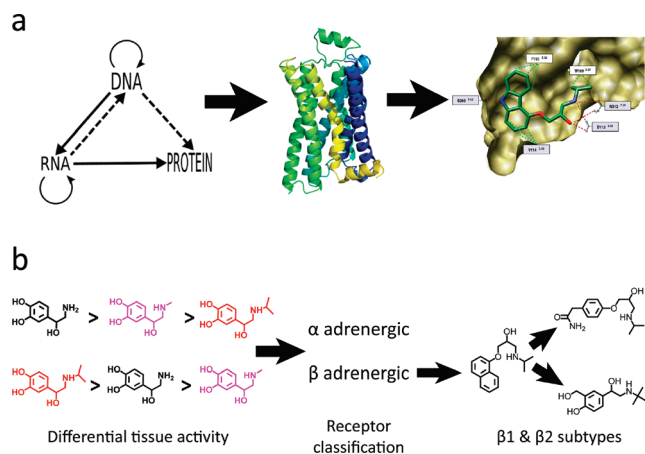

FIGURE 1: Information flow in molecular and classical pharmacology. (a) Central dogma of molecular biology and its sequelae in protein folding and protein function, illustrated through the structure of and ligand recognition by the  $\beta_2$ -adrenergic receptor (63). (b) Ligand-to-target identification in classical pharmacology, illustrated by the classification of receptor subtypes for the  $\beta$ -adrenergic receptors. The differential activity of epinephrine, norepinephrine, and isoproterenol (1) on organ systems disentangled the  $\alpha$ -adrenergic from the  $\beta$ -adrenergic receptors; the  $\beta$ -blocker propranolol was specific for  $\beta$  vs  $\alpha$  receptors, and subsequently, atenolol and salbutamol were specific for the  $\beta_1$  and  $\beta_2$  subtypes, respectively.

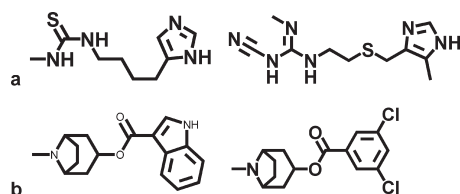

FIGURE 2: Specific, receptor-classifying molecules could lead to drugs. In addition to the  $\beta$ -adrenergic acting drugs illustrated in Figure 1, others include (a) Buramide, the compound used to distinguish the gut-active H2 receptor from the H1 receptor, and Cimetidine, the anti-ulcer drug to which it led. (b) Tropisetron and Bemesetron defined the 5-HT3 subtype because of their specificity for it over the previously characterized 5-HT1 and 5-HT2 receptors. Tropisetron is an anti-nausea drug used after chemotherapy.

receptors are G-protein-coupled receptors (GPCRs)<sup>1</sup> except for 5-HT3, which is an ion channel. By sequence and structure, the 5-HT3 receptor has no similarity whatsoever to the GPCRs whose name it shares. Conversely, 5-HT3 responds to serotonin and its close analogues, as do all of the other members of the 5-HT family, and drugs and reagents that classify this ion channel as 5-HT3 also bind to 5-HT2 at low micromolar concentrations (5) and to the 5-HT4 receptors at midnanomolar concentrations (6); however, these latter are GPCRs. Similarly, the metabotropic glutamate receptors are GPCRs, while the ionotropic glutamate

receptors are ion channels; both respond to glutamate and related molecules. The same is true for the nicotinic and muscarinic acetylcholine receptors, both canonical drug targets. Many transporters, which are dissimilar in structure and sequence to both ion channels and GPCRs, are modulated by drugs and ligands that are characteristic of these latter receptors. Serotonergic receptor drugs modulate serotonin and norepinephrine transporters, and putatively “selective” serotonin reuptake inhibitors modulate adrenergic receptors (below). Conversely, at the molecular biology level, many receptors that are closely related share no ligand similarity. The  $\mu$ -opioid receptor is by sequence and structure similar to the metabotropic serotonin receptors; both are seven-transmembrane GPCRs. There is, however, little similarity among the ligands that modulate them, and many GPCRs sharing high sequence identity have no ligands in common. From a small molecule perspective, saying that 5-HT3 is related to 5-HT4, or that a serotonin transporter is related to an adrenergic receptor, sensibly organizes pharmacology (Figure 3), whereas from a molecular biology view, this is, at least superficially, baffling.

The organization of pharmacology is thus bicameral. On one hand, the molecular biology view can be quantified and reduced to specific, clonable targets and reflects a deep understanding of biology and evolution. On the other hand, the chemical view is the basis of our everyday taxonomy of receptors. Over the past five years, the formal basis of this classic, premolecular biology view has been reinvestigated, leading to new maps of pharmacology and the discovery of new drug activities. Some of these methods are available online and may be used by nonspecialists to frame chemistry-guided questions of biology (<http://sea.bkslab.org>). These might include the following. To what targets might my organic molecule(s) bind, and to what other receptors is my target linked by chemistry? Here, we consider just how common it is to find drugs and reagents that bind to apparently unrelated receptors, the informatics and databases that have allowed this investigation, and some of the new tools developed to exploit them. We consider applications of the chemical view to predict new activities for drugs, to understand their side effects, and to identify the targets for molecules active in phenotypic screens. We close by considering opportunities for a synthesis between the two views, neither of which alone seems fully complete.

## LIGAND–TARGET DATABASES

Over most of the history of pharmacology, investigators made do with few characteristic ligands for any target and it is a testament to the thought and care that went into target characterization that so much was learned from so few molecules. Today, hundreds of thousands of ligands are characterized for thousands of targets; one of the challenges in pharmacology is organizing the weight of information under which the field unsteadily groans. Databases of target–ligand associations have begun to address this problem.

Two sources of target–ligand associations are patents and scientific publications, particularly the medicinal chemistry literature. The drug patent literature has been curated into electronic form by Prous Science (Barcelona, Spain) and formatted and marketed by MDL (now Symyx/Accelrys) as the MDL Drug Data Report (MDDR). Investigators often work with a subset of the MDDR that Schuffenhauer and colleagues associated with a specific biological target in their ontology, as opposed to, for instance, a more general category such as “anti-cancer” (7) (Table 1). The CMC database, also curated and sold by Symyx (8), contains compounds identified in the United States Approved Names (USAN) list. It describes chemical structures, biological activity,

<sup>1</sup>Abbreviations: 5-HT, serotonin receptor; ADR, adenosine receptor; AR, adrenergic receptor; BZRP, benzodiazapine receptor; ChEMBL, The EMBL Medicinal Chemistry Database; CMC, MDL Current Medicinal Chemistry Database; DMT, dimethyltryptamine; ECFP4, extended connectivity fingerprint 4; GPCR, G-protein-coupled receptor; HCS, high-content screening; MAO, monoamine oxidase; MDDR, MDL Drug Data Report; NMDA, *N*-methyl-D-aspartate; PDSP KiDB, National Institutes of Mental Health Psychoactive Drug Screening Program’s *K<sub>i</sub>* Database; SERM, selective estrogen receptor modulator; Tc, Tanimoto coefficient; SEA, Similarity Ensemble Approach; SMILES, simplified molecular input line entry specification; USAN, United States Approved Name; VMAT2, vesicular monoamine transporter 2; WOMBAT, World of Biomolecular Activity Database.

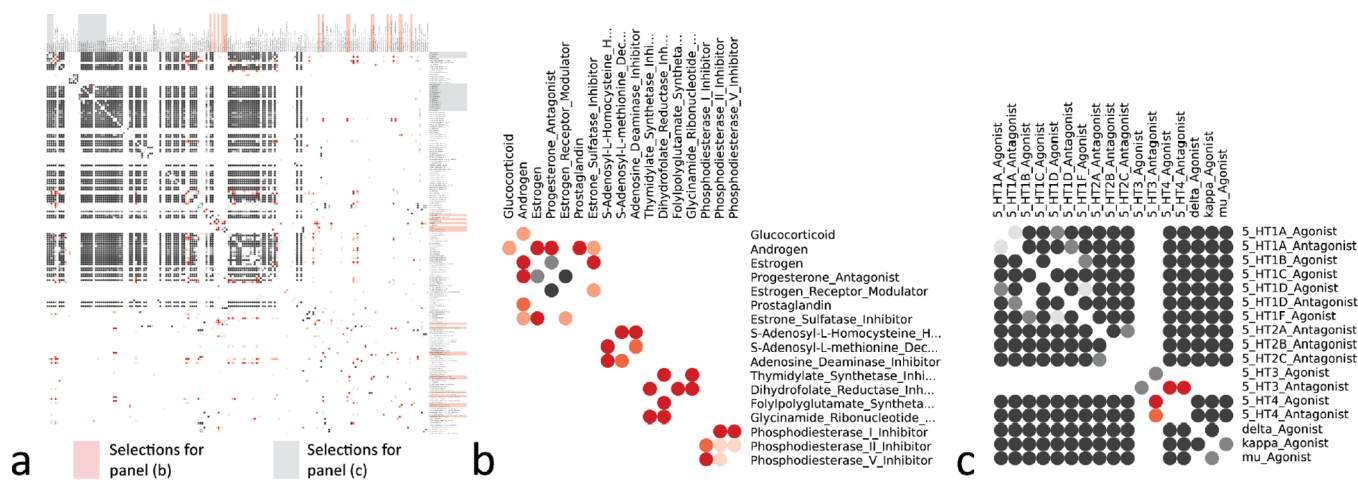

FIGURE 3: Receptors with high degrees of sequence similarity but little ligand similarity, and the converse. (a) Overall comparison of ligand similarity with sequence similarity for drug targets. Approximately 250 drug targets from the MDDR were compared against each other in a full matrix, first by a ligand similarity method [SEA (22)] and then by a protein sequence similarity method [PSI-BLAST (64)]. Where both methods agree, the matrix is white. Thus, both find that any given target pair on the diagonal, such as 5-HT2A vs itself, resembles itself. Where ligand similarity was stronger than sequence similarity the matrix is red; where the converse is true, it is dark gray. (b) Excerpt of the matrix in which the degree of ligand similarity is high but the degree of sequence similarity is low. This region includes enzymes and nuclear hormone receptors. (c) Excerpt from the region with a high degree of sequence similarity (but a low degree of ligand similarity). These are often GPCRs. Reproduced from ref 22. Copyright 2007 Nature Publishing Group.

Table 1: Some Widely Used Ligand–Target Databases

database	version	no. of ligands	no. of targets	no. of data points
MDDR (8)	2010.1	201761	631	391406
Schuffenhauer MDDR (7)	2006	65242	247	71197
WOMBAT (10)	2010.1	254679	2100	760605
ChEMBL-complete (11)	05 (July 2010)	578715	7493	2787240
ChEMBL-protein targets	03 (May 2010)	222177	3153	600165
BindingDB.org (61)	2010	240203	3056	544641
PDSP KiDB (62)	2010	7315	722	48083

drug class, originating company, and literature references. It does not contain immediately useful drug–target associations but remains a valuable source of information for predicting drug–target associations and complements the MDDR. Similarly, Boyer and colleagues at IBM have created a fully automated patent parsing engine to create a database of ligand–target–disease associations; this database is available commercially (9).

Two databases of literature-based target–ligand associations are widely used. Among the first of these was the World of Biomolecular Activity database (WOMBAT) (10), which covers most of the past 20 years of the *Journal of Medicinal Chemistry* and nearly a decade of the next three most important medicinal chemistry journals and has partial coverage of several others. It annotates targets with SwissProt and Uniprot codes, where available, and differentiates agonists from antagonists, a level of detail helpful to target prediction and often not available in other databases. WOMBAT is a commercial product but is also accessible collaboratively from its authors at Sunset Molecular (<http://www.sunsetmolecular.com/>). Recently, the ChEMBL database has become freely available via the European Bioinformatics Institute (EBI) (11). This library is actively curated and annotates more than half a million ligands with more than 3000 targets; it is freely accessible at <http://www.ebi.ac.uk/chembl/>.

## REPRESENTING AND COMPARING LIGAND STRUCTURES

Interrogating the relationships among the hundreds of thousands of ligands and thousands of targets that are described in

ligand–target annotation databases demands ligand representations that support rapid comparisons. This is often accomplished with molecular fingerprints, usually expressed as a bit string. Widely used examples include Daylight (12) (Figure 4a) and Scitegic extended connectivity fingerprints (13), which encode topological [two-dimensional (2D)] information, e.g., atom types and the bond connectivity among them, though there are many others that are also popular. To those trained in biochemistry and biophysics, the idea that a topological fingerprint of a small molecule can be informative seems hard to credit, and indeed, there has been considerable effort to develop more information-rich three-dimensional (3D) methods (14–17). Still, topological fingerprints have proven themselves to be surprisingly robust for many cheminformatics approaches and are what we rely on for our own work.

The most common way to compare molecular fingerprints for similarity uses the Tanimoto coefficient ( $T_c$ ) (18, 19), which compares the number of “on” bits shared between two fingerprints to all the on bits that could have been matched between them (Figure 4b). Developed in 1957, this metric (20) extends the Jaccard coefficient, used in 1901 to compare similarity and diversity among alpine flowers (21). The  $T_c$  measures the overall level of similarity between two molecules and is symmetric, e.g.,  $T_c(fp_a, fp_b) = T_c(fp_b, fp_a)$ . Like the 2D fingerprints that it is asked to compare, the Tanimoto coefficient has substantial theoretical and practical limitations; it is not a true distance measurement as it violates the triangle inequality, nor is there any accepted demarcation in  $T_c$  that identifies ligands that are functionally



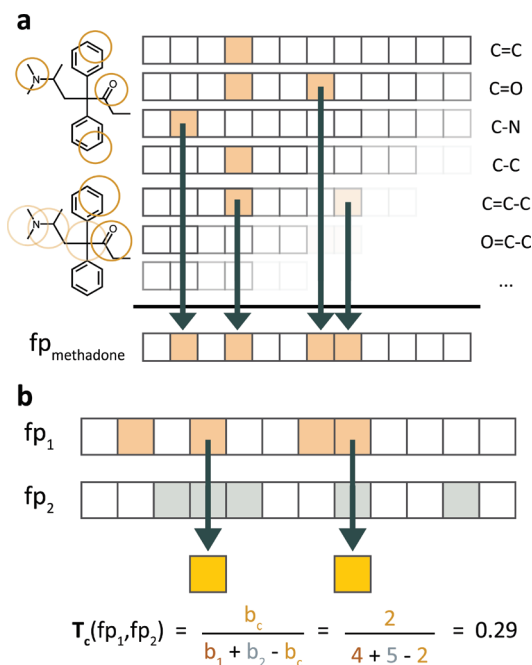

FIGURE 4: Representing molecules as topological fingerprints. (a) Encoding a molecule using Daylight fingerprints. Each atom-to-atom path across the molecule of increasing length is iteratively encoded as a bit string, and all of the bit strings are combined together into a final “fingerprint”. (b) Comparing fingerprints using a Tanimoto coefficient ( $T_c$ ). The  $T_c$  calculates the number of on bits in common between the fingerprints divided by the total number of nonoverlapping bits between fingerprints.

related, notwithstanding much effort (19). This has limited the reliability of simple chemical similarity in predicting ligand-based associations and has inspired the weighting of chemical similarity using statistical models of significance. These models have improved our ability to assign confidence to measurements of ligand similarity and especially to the similarity of sets of ligands (13, 22).

## REORGANIZING BIOLOGY ON THE BASIS OF LIGAND RECOGNITION

An ambition of the chemical approach is to reorganize pharmacological maps, associations among proteins, on the basis of ligand similarities rather than sequence, structural, or pathway similarities. Several approaches have been explored, most mining the rich veins of ligand–target associations available in the databases. Among the first to illuminate the unexpected relationships that emerge from such an analysis were Paolini, Hopkins, and colleagues (23), who found that many bioactive small molecules possessed extensive polypharmacology, often across target boundaries (Figure 5b). For instance, ligands active on aminergic GPCRs were often observed to have activity on protein kinases; protein kinase ligands in turn had unexpected activities on ion channels and on phosphodiesterases. Vidal and colleagues (24) analyzed graph connectivity of drug target networks (Figure 5a), and Mestres (25) combined data sources to build expanded target networks. The drug–target associations studied by Vidal et al. suggested that most new drugs acted on targets that had been previously drugged, not itself surprising, but more encouragingly, there was an evolution toward more diverse targets over time. Surprisingly, correlating the drug–target map with a disease–protein map suggested that many drugs were not acting on a protein most directly implicated in a disease but rather were acting at one or two degrees of separation, at proteins that themselves were linked to the disease genes.

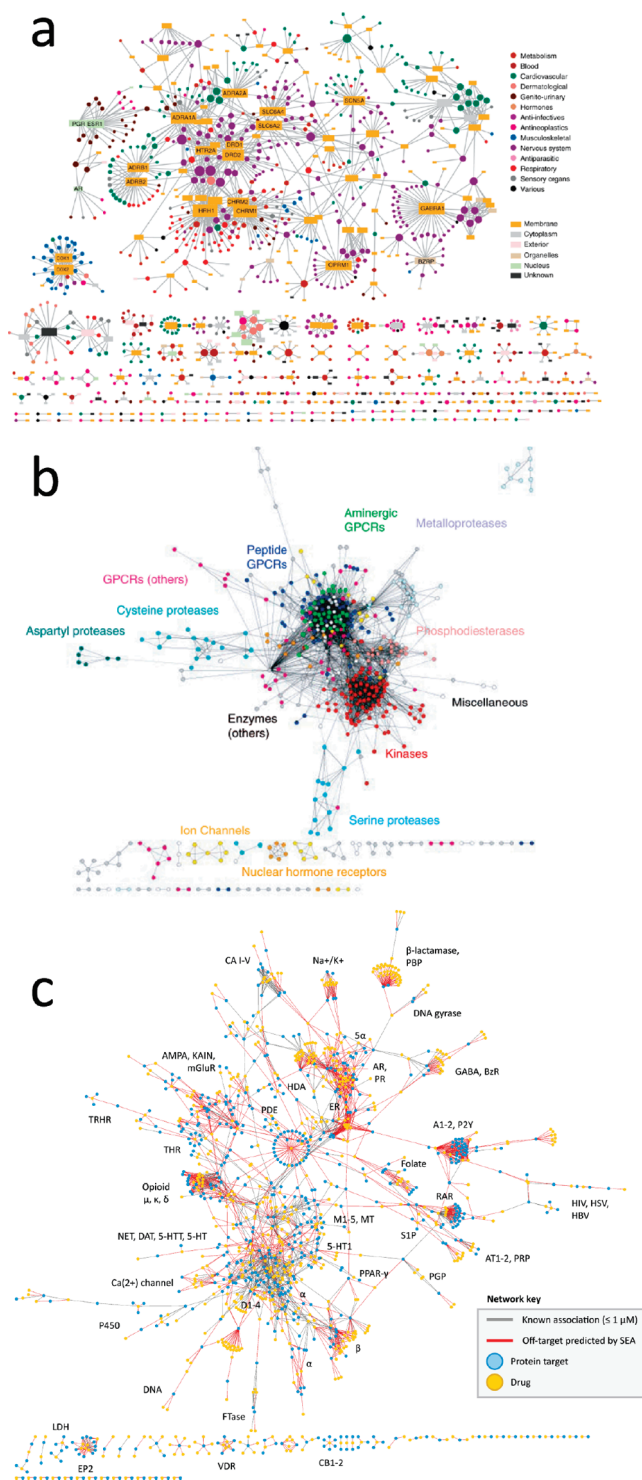

FIGURE 5: Varied approaches to organizing drug protein targets by their ligands. (a) Drug–target network linking FDA drugs (circles) to targets (rectangles) based on the known associations. Drugs are colored by their Anatomical Therapeutic Chemical Classification and target proteins by their Gene Ontology cellular component (24). (b) Target–target network, in which targets are linked if they bind one or more compound in common, within a preset affinity threshold. There are 486 targets, colored by gene family, linked by 3636 edges (23). (c) Predicted drug–target network. Each drug (gold) is linked to its known protein targets (cyan) by a gray edge. Red edges link drugs to their additionally predicted targets (41).

Proteins may be associated on the basis of not only known but also predicted polypharmacology (Figure 5c). In our own work, we have linked receptors on the basis of similarities among the

sets of ligands annotated to bind to them. For two proteins to be related, no single ligand need be shared between them, but overall, the patterns of chemistry among their ligand sets must be similar, hence a “Similarity Ensemble Approach” (SEA) (22, 26). It is here where we found that a statistical model for relating similarities to those expected at random was critical. The model was motivated by empirical BLAST theory (13, 27), where individual ligands now replaced the unordered “words” used in heuristic sequence alignment, with both scoring systems using extreme value distributions.

Common to these chemocentric networks is the reorganization of the target boundaries and associations to which we have become accustomed from molecular biology. To those trained in the molecular, reductionist paradigm, as we ourselves have been, it may seem peculiar that an ion channel will be associated with a transporter, a transporter with a GPCR, a human adrenergic GPCR with a parasitic ribosome, and an aminergic GPCR with peptide and chemokine GPCRs. From a chemical perspective, however, the similarities among the ligand sets are striking. They are also generative, predicting previously unknown associations and crosses. Because they are based on specific, organic molecules, these predictions may be directly tested by an experimental assay on the same molecules that articulate them. It is to such testing, and its relevance to drug biology and target identification, that we now turn.

#### APPLICATIONS OF THE CHEMICAL VIEW

In the past 4 years, more than 30 drugs have been tested against more than 40 novel off-targets based on chemocentric predictions [summarized in Table 2; others have been proposed on the basis of target structure-based approaches (28–39), but these fall out of the remit of this paper]. Some of these new off-targets are consistent with drug side effects, whereas others may bolster a drug’s on-target action; we consider each case in turn. Such off-target binding may cross target structure and fold categories, such as when an ion channel inhibitor is found also to modulate GPCRs, and we consider examples of such molecules at the close of the section.

*Off-Targets Mediating Side Effects.* Unintended off targets are widely associated with adverse drug reactions and are widely feared in drug discovery. An innovative idea pioneered by Campillos, Bork, and colleagues was to exploit known side effects to organize drugs into networks by similarities among the profiles listed on their package inserts (40). From these networks, they predicted and experimentally confirmed 13 cases of novel drug off-target activity (selections in Table 2). In one example, they identified a subnetwork in which the CNS drugs pergolide, paroxetine, fluoxetine, and zolmitriptan were clustered around the anti-ulcer drug rabeprazole, a proton pump inhibitor. This led them to predict and show that rabeprazole would bind two CNS targets known for these drugs, the dopamine D3 (1.6  $\mu\text{M}$ ) and 5-HT1D (7.6  $\mu\text{M}$ ) receptors (Table 2). As rabeprazole plasma concentrations reach these levels, this may suggest that it should also be investigated for the side effects already associated with these nervous system targets (40) (whether the fraction unbound, FU, reaches these levels is not clear).



Side effect targets also emerge from approaches based strictly on ligand chemistry [Table 2 (22, 41)]. The SEA method was used to predict that the amebicide emetine would modulate the  $\alpha_2$ -adrenergic receptor. Whereas these two targets have no obvious structural similarity, inspection of emetine’s structure

reveals its striking similarity to adrenergic ligands. This prediction was subsequently tested experimentally and shown to occur at 1  $\mu\text{M}$  (22). Consistent with adrenergic activity, the side effects of emetine include hypotension, tachycardia, and congestive heart failure. Similarly, the well-known  $\mu$ -opioid agonist methadone was predicted to bind to the muscarinic M3 receptor (22); this is consistent with, though of course far from establishes the basis of, methadone’s unusual side effects for an opioid agonist, including the heavy sweating that patients report with it. Using the same approach, Motilium, used by nursing mothers to stimulate lactation, was predicted and found to bind to the  $\alpha_1\text{A}$  receptors, here at 71 nM (41). This activity is consistent with the cardiac effects observed with Motilium (though admittedly so is its known hERG activity, at 5  $\mu\text{M}$ ). Finally, the widely used SSRIs Prozac and Paxil were predicted to bind  $\beta_1$ -adrenergic receptors, the blockade of which is consistent with changes in heart rate observed in SSRI discontinuation syndrome and the sexual dysfunction induced by these antidepressants (41). Prozac and Paxil’s  $\beta$ -binding was only at the threshold of their plasma concentrations, without considering the fraction unbound, but a pilot study has recently correlated a common  $\beta_1$ -adrenergic gene single-nucleotide polymorphism (SNP) known to increase sensitivity to  $\beta$ -blockers with these Prozac- and Paxil-induced changes in heart rate and diastolic blood pressure (42). Efforts to predict adverse drug reactions (ADRs) are also well advanced in several pharmaceutical companies, though most reports in the open literature have been restricted to retrospective correlation. The extent of these studies nevertheless suggests that this is an active area of research (43–47).

*Off-Targets as Primary Sites of Action.* Predicted targets can also illuminate the primary mechanism of action of drugs, or opportunities for repurposing drugs to treat new diseases. di Bernardo and colleagues have made a case for the use of Fasudil in cancer and in certain neurodegenerative diseases (48). Using their Mode of Action by Network Analysis (MANTRA) method, the authors leveraged the Connectivity Map (49, 50) collection to group drugs into “communities” by similarities in their patterns of specific transcriptional responses. By asking which known drugs if any were most similar to 2-deoxy-D-glucose, a known inducer of autophagy, they predicted and demonstrated strong activation of autophagic degradation by Fasudil in both human fibroblasts and HeLa cells (48). In other examples of potentially useful new targets, Bork and colleagues noted that the acetylcholinesterase inhibitor donepezil may also find use in depression, consistent with its binding to the serotonin re-uptake transporter, and Distefano’s group demonstrated miconazole’s ability to disrupt H-ras oncogene localization in cells, consistent with its predicted inhibition of protein farnesyltransferase (51). While these two activities were found for weakly binding off targets, this is not always the case; the antihypertensive Dorales unexpectedly bound the dopamine D<sub>4</sub> receptor a log order more tightly (18 nM) than it does its canonical  $\alpha$ -adrenergic on target (200–600 nM) (41).

Where a drug’s mode of action is unknown, chemocentric approaches can narrow the field of inquiry. The hallucinogen *N,N*-dimethyltryptamine (DMT) was observed to have a  $K_d$  of 14.8  $\mu\text{M}$  for the  $\sigma_1$  receptor, implicating this target in its hallucinogenic properties and potentially identifying an endogenous ligand for  $\sigma_1$  (52, 53). This was surprising given the promiscuous and sometimes potent activity on  $\sigma_1$  of many non-hallucinogens, and DMT binds targets already implicated in hallucination, the serotonin receptors (54–56). In a blind computational panel,

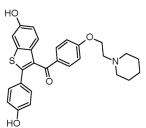
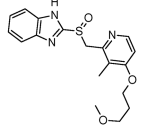
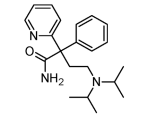
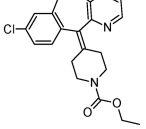
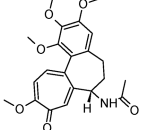
Table 2: Novel Off-Target Predictions for Known Drugs

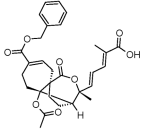
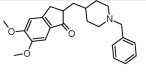
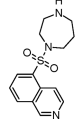
Drug / Pharmacological Action	Prediction Method	Predicted Target	$K_i$ (nM)
 <b>Raloxifene</b> Selective estrogen receptor modulator (SERM); Osteoporosis prophylactic	Side-effect	5-HT <sub>1D</sub>	300
 <b>Rabeprazole</b> Antiulcerative	Side-effect	Dopamine D <sub>3</sub>	1600
 <b>Disopyramide</b> Class-I anti-arrhythmic	Side-effect	Histamine H <sub>1</sub>	2700
 <b>Claritin</b> Antihistamine	Side-effect	BZRP	5000
 <b>Colchicine</b> Treatment for gout, Mediterranean fever	HCS (60)	$\alpha$ -tubulin	Micrograph
 <b>Quinoline</b> Tryptophan metabolite; Possible role in neurodegenerative disease	HCS	$\alpha$ -tubulin	Micrograph
 <b>Pseudolarix acid B</b> Natural product of <i>Pseudolarix kaempferi</i> Gordon	HCS	$\alpha$ -tubulin	Micrograph
 <b>Donepezil</b> Nootropic	Side-effect	5-HTT	9000
 <b>Fasudil</b> Rho-kinase inhibitor	MANTRA (48)	Cellular autophagy (via LC3-II levels in human fibroblasts)	10000, Western blot

SEA predicted both known and novel serotonin receptor subtype binding for DMT, and subsequent ligand displacement studies suggested that it does so with affinities in the range of 100 nM, 2 log more potent than its  $\sigma_1$  binding. More compellingly, whereas DMT shows strong activity in a mouse model for hallucination, the 5-HT<sub>2A</sub> knockout mouse, one of the predicted and observed targets, did not respond to DMT, consistent with its status as DMT's primary target (41). Other efforts to "deorphanize" drugs and candidates more broadly are ongoing.

*Targets from Phenotypes.* A new direction in drug discovery and chemical biology is phenotypic screening. Compound

libraries are screened for phenotypic outcomes in a cell or whole organism. This returns to an older pharmacological modality, in which a "model system" might be a guinea pig ileum perfused in an solution of compound (57), except that now tens of thousands of compounds are screened. This can result in interesting whole animal phenotypes for several chemical series, whose targets nonetheless remain unclear. Identifying these targets is perhaps the key challenge in such "forward chemical genetic" screens. In a recent study, Peterson and colleagues quantified the response of zebrafish embryos to light and the modulation of this response by preincubation of the fish with small molecules (58, 59).

Table 2. Continued

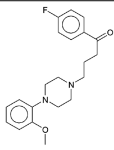
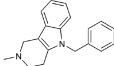
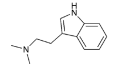
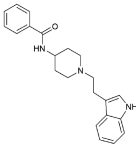
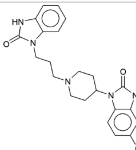
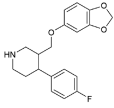
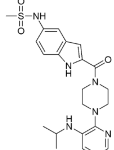
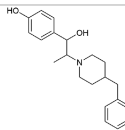
Drug / Pharmacological Action	Prediction Method	Predicted Target	$K_i$ (nM)	
 <b>Sedalande</b> Neuroleptic	SEA (41)	$\alpha_1$ Adrenergic	$\alpha_{1A}$ 1.2 $\alpha_{1B}$ 14 $\alpha_{1D}$ 7	
		SEA	5-HT <sub>1D</sub>	137
		SEA	5-HT <sub>5A</sub>	129
 <b>Fabahistin</b> Antihistamine	SEA	5-HT <sub>1B</sub>	129	
	SEA	5-HT <sub>2A</sub>	127	
 <b>N,N-dimethyltryptamine</b> Serotonergic hallucinogen	SEA	5-HT <sub>5A</sub>	2135	
	SEA	5-HT <sub>7</sub>	206	
	SEA	Dopamine D <sub>4</sub>	18	
 <b>Doralese</b> Adrenergic $\alpha_1$ blocker; Antihypertensant; Antimigraine	SEA	Dopamine D <sub>3</sub>	2000	
	SEA	$\beta$ Adrenergic	$\beta_1$ 4385	
 <b>Motilium</b> Antiemetic; Peristaltic stimulant	SEA	$\alpha_1$ Adrenergic	$\alpha_{1A}$ 71 $\alpha_{1B}$ 525 $\alpha_{1D}$ 705	
		Side-effect (40)	Dopamine D <sub>3</sub>	3800
		SEA	$\beta$ Adrenergic	$\beta_1$ 10420
 <b>Paxil</b> 5-HT reuptake inhibitor; Antidepressant	SEA	$\alpha_2$ Adrenergic	$\alpha_{2A}$ 959 $\alpha_{2C}$ 1318	
	SEA	Histamine H <sub>4</sub>	5334	
 <b>Rescriptor</b> HIV-1 reverse transcriptase inhibitor	SEA	5-HTT (Serotonin transporter)	77	
	SEA	$\mu$ Opioid	1423	
 <b>Vadilex</b> Selective NMDAR inhibitor	SEA (51)	Protein farnesyltransferase	18900	
	SEA (51)	Protein farnesyltransferase	18900	



Similarities among the phenotypes organized compounds into broad activity classes (59). Where a compound's activity was unknown, SEA was used to suggest specific molecular targets. Consistent with SEA prediction, one such phenotypic hit, MAG-1, was found to be a 1 nM inhibitor of MAO in direct kinetic inhibition studies (58). Work in this area is ongoing.

Other approaches to uncovering mechanisms of action incorporate an even greater number of data sources. Using factor analysis over phenotypic profiles, chemical similarity, and predicted protein binding, Feng and colleagues derived mechanism of action inferences from a high-content cellular screen (HCS, selections in Table 2) (60). Fluorescent cell cycle markers were observed in microscopy to derive phenotypic profiles associated with particular compounds. Clustering these phenotypic profiles suggested structure–activity relationships among the small molecules consistent with their structural patterns and known activities. For instance, a subcluster associated with cell death contained several known cytotoxics such as Diperamycin and Kendomycin, whereas a subcluster associated with G1 arrest contained corticosteroids such as Dexamethasone and Triamcinolone (60). To illustrate the value of phenotypic profiles in predicting targets for small molecules, the authors then showed that from the phenotypes a common target,  $\alpha$ -tubulin, could be inferred for three groups of phenotypically similar yet structurally distinct molecules (e.g., colchicine, quinoline, and pseudolarix acid B), a prediction that they confirmed via micrographs of stained cells (60).

## OPPORTUNITIES AND UNSOLVED PROBLEMS

It is almost perplexing that the chemical view of pharmacology, which has little basis in physical or biological theory, works as well as it does to relate targets and discover drugs. Conversely, the molecular biology view, representing our best understanding of biology, has curious gaps in pharmacological organization and a checkered career in drug discovery. Pharmaceutical research is by now dominated by the reductionist program, and even a new direction like chemical biology models itself on molecular biology and molecular genetics. Still, in the past 15 years, the pharmaceutical industry has struggled to produce enough new drugs to keep up with the expectations raised for it by those introduced in the late 1980s and 1990s, most discovered using the older, chemical approach to pharmacology. How might this discrepancy, between the successes of a theoretically impoverished chemical view and the failures of a rich molecular biology one, be reconciled?

The dilemma is partly resolved by the domain of questions that the two views are asked to address. As long as pharmacology involves the actions of drugs and reagents on biology, then a view that begins and ends with these will have an advantage. The chemical view does not pretend to characterize all of biology or its mechanisms, which is the molecular biology program, but restricts itself to those targets with which bioactive molecules interact. Thus, the observation that the  $\mu$ -opioid and 5-HT<sub>2A</sub> receptors are related by sequence never occurs to the chemical view. The relationship among these targets, which arguably for drug action is often irrelevant and even confusing, is meaningful in other contexts and reflects shared evolution and signaling. Correspondingly, the NMDA ion channel is related to the  $\kappa$ -opioid receptor only through the similarity of the drugs that modulate it; for many other biological questions, this similarity is as meaningless as the lack of sequence and structural similarity between them suggests. When the carrier of information is itself a small molecule, then that molecule may illuminate the bases of diseases in which the target is involved and sometimes also treat them. The chemical

view of biology had a feeling-around-in-the-dark aspect to it and was often deeply frustrating to its practitioners, but it was necessarily focused on reagents that might themselves become drugs.

We do not pretend that drug discovery should return to this chemical approach to pharmacology or even that the chemical approach, despite its age, is mature. We do not understand the physical basis for the binding of related ligands to unrelated targets; we have merely exploited that observation. We lack a theoretical basis for information flow in the chemical view, and often the most pragmatic representations of chemical information, such as topological fingerprints, are deeply unsatisfying. Developments in these areas will move the chemical view from pattern recognition to a theoretically grounded science, helping to reintegrate the bicameral house of pharmacology. This will be crucial to meet the promise of both chambers. The chemical approach will benefit from adopting the substantial statistical, physical, and evolutionary theory that has gone into molecular biology and protein structure. Correspondingly, the sharp focus on small molecules that the chemical view brings will give the molecular biology view ready access to reagents that can modulate the receptors that it has done so much to illuminate.

In 1941, the first edition of Goodman and Gilman's *The Pharmacological Basis of Therapeutics* appeared. Its title revealed a program of research based on the specific modulation of receptors by organic molecules, the behavior of which in the body could be monitored, understood, and exploited. What was then provocative is today so well accepted that the book's title seems antique. At the time, the chemical basis of pharmacology needed no emphasis, so focused was the field on the actions of molecules that were not only its goals but also its primary classifiers and biological informants. Whereas Goodman and Gilman continues to be a central text, the classical pharmacology that it once represented has largely disappeared, as has the chemical view of biology. As primitive as that view remains, the opportunities for its exploitation are clear. The new methods sketched here systematically and comprehensively compare those targets for which ligand information is available. This remains a blinkered perspective, requiring preexisting ligand information, and so it retains some of the frustrations of classical pharmacology that made that field so receptive to the molecular biology wave that broke upon it in the mid-1980s. In its favor, the chemical view retains the integrationist program implicit in classical pharmacology. Classical pharmacologists often worked on whole organs and were systems biologists *avant la lettre*. As cipherlike as organic molecules can seem as information carriers, they can report on the similarities of pathways and systems as easily as individual receptors. What is new in the past few years is the quantitative restatement of classical ideas, allowing formal comparisons among targets and ligands at a scale not previously attempted. This has suggested unexpected relationships among receptors, identified targets active in phenotypic screens (58), and predicted off-targets and new disease indications for drugs (40). The new techniques remain largely the domain of specialists, but at least some of them are accessible to general investigators interested in bringing new chemical tools to targets and systems of vital interest to themselves (see, for instance, <http://sea.bkslab.org>).

## ACKNOWLEDGMENT

We thank Bryan Roth and Randy Peterson for insightful conversations and collaboration in the experimental part of our research program. We thank R. Shoichet for reading this



manuscript and A. Rochester and D. Barker for the table of contents graphic. The authors declare a competing financial interest.

## REFERENCES

- Ahlquist, R. P. (1948) A study of the adrenotropic receptors. *Am. J. Physiol.* **153**, 586–600.
- Lands, A. M., Arnold, A., McAuliff, J. P., Luduena, F. P., and Brown, T. G., Jr. (1967) Differentiation of receptor systems activated by sympathomimetic amines. *Nature* **214**, 597–598.
- Black, J. W., Duncan, W. A., Durant, C. J., Ganellin, C. R., and Parsons, E. M. (1972) Definition and antagonism of histamine H<sub>2</sub>-receptors. *Nature* **236**, 385–390.
- Richardson, B. P., Engel, G., Donatsch, P., and Stadler, P. A. (1985) Identification of serotonin M-receptor subtypes and their specific blockade by a new class of drugs. *Nature* **316**, 126–131.
- Toll, L., Berzetei-Gurske, I. P., Polgar, W. E., Brandt, S. R., Adapa, I. D., Rodriguez, L., Schwartz, R. W., Haggart, D., O'Brien, A., White, A., Kennedy, J. M., Craymer, K., Farrington, L., and Auh, J. S. (1998) Standard binding and functional assays related to medications development division testing for potential cocaine and opiate narcotic treatment medications. *NIDA Res. Monogr.* **178**, 440–466.
- Ansanay, H., Sebben, M., Bockeaert, J., and Dumuis, A. (1996) Pharmacological comparison between [<sup>3</sup>H]GR 113808 binding sites and functional 5-HT<sub>4</sub> receptors in neurons. *Eur. J. Pharmacol.* **298**, 165–174.
- Schuffenhauer, A., Zimmermann, J., Stoop, R., van der Vyver, J. J., Lecchini, S., and Jacoby, E. (2002) An ontology for pharmaceutical ligands and its application for in silico screening and library design. *J. Chem. Inf. Comput. Sci.* **42**, 947–955.
- MDDR (2010) Symyx-Proux.
- Chen, Y., Spangler, S., Kreulen, J., Boyer, S., Griffin, T. D., Alba, A., Behal, A., He, B., Kato, L., Lelescu, A., Wu, X., Zhang, L., and Kieliszewski, C. (2009) SIMPLE: A Strategic Information Mining Platform for IP Excellence. In RJ10450, IBM Research Division, San Jose, CA.
- Olah, M., Rad, R., Ostopovici, L., Bora, A., Hadaruga, N., Hadaruga, D., Moldovan, R., Fulfias, A., Mracec, M., and Oprea, T. I. (2007) WOMBAT and WOMBAT-PK: Bioactivity Databases for Lead and Drug Discovery. In *Chemical Biology: From Small Molecules to Systems Biology and Drug Design* (Schreiber, S. L., Kapoor, T. M., and Wess, G., Eds.) pp 760–786, Wiley-VCH, New York.
- Overington, J. (2009) ChEMBL. An interview with John Overington, team leader, chemogenomics at the European Bioinformatics Institute Outstation of the European Molecular Biology Laboratory (EMBL-EBI). Interview by Wendy A. Warr. *J. Comput.-Aided Mol. Des.* **23**, 195–198.
- James, C., Weininger, D., and Delany, J. (1992–2005) Daylight theory manual, Daylight Chemical Information Systems Inc., Mission Viejo, CA.
- Hert, J., Keiser, M. J., Irwin, J. J., Oprea, T. I., and Shoichet, B. K. (2008) Quantifying the relationships among drug classes. *J. Chem. Inf. Model.* **48**, 755–765.
- Rush, T. S., III, Grant, J. A., Mosyak, L., and Nicholls, A. (2005) A shape-based 3-D scaffold hopping method and its application to a bacterial protein-protein interaction. *J. Med. Chem.* **48**, 1489–1495.
- ROCS (Rapid Overlay of Chemical Structures), version 2.0 (2004) OpenEye Scientific Software, Santa Fe, NM.
- Jenkins, J. L., Glick, M., and Davies, J. W. (2004) A 3D similarity method for scaffold hopping from known drugs or natural ligands to new chemotypes. *J. Med. Chem.* **47**, 6144–6159.
- Jain, A. N. (2000) Morphological similarity: A 3D molecular similarity method correlated with protein-ligand recognition. *J. Comput.-Aided Mol. Des.* **14**, 199–213.
- Willett, P. (1987) Similarity and clustering in chemical information systems, Research Studies Press, Wiley, Letchworth, Hertfordshire, England.
- Brown, R. D., and Martin, Y. C. (1996) Use of structure Activity data to compare structure-based clustering methods and descriptors for use in compound selection. *J. Chem. Inf. Comput. Sci.* **36**, 572–584.
- Tanimoto, T. (1957) IBM Internal Report, Nov 17, 1957.
- Jaccard, P. (1901) Étude comparative de la distribution florale dans une portion des Alpes et des Jura. *Bull. Soc. Vaudoise Sci. Nat.* **37**, 547–579.
- Keiser, M. J., Roth, B. L., Armbruster, B. N., Ernsberger, P., Irwin, J. J., and Shoichet, B. K. (2007) Relating protein pharmacology by ligand chemistry. *Nat. Biotechnol.* **25**, 197–206.
- Paolini, G. V., Shapland, R. H., van Hoorn, W. P., Mason, J. S., and Hopkins, A. L. (2006) Global mapping of pharmacological space. *Nat. Biotechnol.* **24**, 805–815.
- Yildirim, M. A., Goh, K. I., Cusick, M. E., Barabasi, A. L., and Vidal, M. (2007) Drug-target network. *Nat. Biotechnol.* **25**, 1119–1126.
- Mestres, J., Gregori-Puigjane, E., Valverde, S., and Sole, R. V. (2009) The topology of drug-target interaction networks: Implicit dependence on drug properties and target families. *Mol. Biosyst.* **5**, 1051–1057.
- Keiser, M. J., and Hert, J. (2009) Off-target networks derived from ligand set similarity. *Methods Mol. Biol.* **575**, 195–205.
- Altschul, S. F., Gish, W., Miller, W., Myers, E. W., and Lipman, D. J. (1990) Basic local alignment search tool. *J. Mol. Biol.* **215**, 403–410.
- Kinnings, S. L., Liu, N., Buchmeier, N., Tonge, P. J., Xie, L., and Bourne, P. E. (2009) Drug discovery using chemical systems biology: Repositioning the safe medicine Comtan to treat multi-drug and extensively drug resistant tuberculosis. *PLoS Comput. Biol.* **5**, e1000423.
- Xie, L., and Bourne, P. E. (2008) Detecting evolutionary relationships across existing fold space, using sequence order-independent profile-profile alignments. *Proc. Natl. Acad. Sci. U.S.A.* **105**, 5441–5446.
- Xie, L., Wang, J., and Bourne, P. E. (2007) In silico elucidation of the molecular mechanism defining the adverse effect of selective estrogen receptor modulators. *PLoS Comput. Biol.* **3**, e217.
- Kellenberger, E., Muller, P., Schalon, C., Bret, G., Foata, N., and Rognan, D. (2006) sc-PDB: An annotated database of druggable binding sites from the Protein Data Bank. *J. Chem. Inf. Model.* **46**, 717–727.
- De Franchi, E., Schalon, C., Messa, M., Onofri, F., Benfenati, F., and Rognan, D. (2010) Binding of protein kinase inhibitors to synapsin I inferred from pair-wise binding site similarity measurements. *PLoS One* **5**, No. e12214.
- Stauch, B., Hofmann, H., Perkovic, M., Weisel, M., Kopietz, F., Cichutek, K., Munk, C., and Schneider, G. (2009) Model structure of APOBEC3C reveals a binding pocket modulating ribonucleic acid interaction required for encapsidation. *Proc. Natl. Acad. Sci. U.S.A.* **106**, 12079–12084.
- Rollinger, J. M., Schuster, D., Danzl, B., Schwaiger, S., Markt, P., Schmidtko, M., Gertsch, J., Raduner, S., Wolber, G., Langer, T., and Stuppner, H. (2009) In silico target fishing for rationalized ligand discovery exemplified on constituents of *Ruta graveolens*. *Planta Med.* **75**, 195–204.
- Aronov, A. M., Munagala, N. R., Kuntz, I. D., and Wang, C. C. (2001) Virtual screening of combinatorial libraries across a gene family: In search of inhibitors of *Giardia lamblia* guanine phosphoribosyltransferase. *Antimicrob. Agents Chemother.* **45**, 2571–2576.
- Cai, J., Han, C., Hu, T., Zhang, J., Wu, D., Wang, F., Liu, Y., Ding, J., Chen, K., Yue, J., Shen, X., and Jiang, H. (2006) Peptide deformylase is a potential target for anti-*Helicobacter pylori* drugs: Reverse docking, enzymatic assay, and X-ray crystallography validation. *Protein Sci.* **15**, 2071–2081.
- Rarey, M., Kramer, B., Lengauer, T., and Klebe, G. (1996) A fast flexible docking method using an incremental construction algorithm. *J. Mol. Biol.* **261**, 470–489.
- Muller, P., Lena, G., Boilard, E., Bezzine, S., Lambeau, G., Guichard, G., and Rognan, D. (2006) In silico-guided target identification of a scaffold-focused library: 1,3,5-Triazepan-2,6-diones as novel phospholipase A2 inhibitors. *J. Med. Chem.* **49**, 6768–6778.
- Hermann, J. C., Marti-Arbona, R., Fedorov, A. A., Fedorov, E., Almo, S. C., Shoichet, B. K., and Raushel, F. M. (2007) Structure-based activity prediction for an enzyme of unknown function. *Nature* **448**, 775–779.
- Campillos, M., Kuhn, M., Gavin, A. C., Jensen, L. J., and Bork, P. (2008) Drug target identification using side-effect similarity. *Science* **321**, 263–266.
- Keiser, M. J., Setola, V., Irwin, J. J., Laggner, C., Abbas, A. I., Hufeisen, S. J., Jensen, N. H., Kuijer, M. B., Matos, R. C., Tran, T. B., Whaley, R., Glennon, R. A., Hert, J., Thomas, K. L., Edwards, D. D., Shoichet, B. K., and Roth, B. L. (2009) Predicting new molecular targets for known drugs. *Nature* **462**, 175–181.
- Thomas, K. L., Ellingrod, V. L., Bishop, J. R., and Keiser, M. J. (2010) A Pilot Study of the Pharmacodynamic Impact of SSRI Drug Selection and  $\beta$ -1 Receptor Genotype (ADRB1) on Cardiac Vital Signs in Depressed Patients: A Novel Pharmacogenetic Approach. *Psychopharmacol. Bull.* **43**, 11–22.
- Bender, A., Scheiber, J., Glick, M., Davies, J. W., Azaoui, K., Hamon, J., Urban, L., Whitebread, S., and Jenkins, J. L. (2007) Analysis of pharmacology data and the prediction of adverse drug reactions and off-target effects from chemical structure. *ChemMedChem* **2**, 861–873.
- Scheiber, J., and Jenkins, J. L. (2009) Chemogenomic analysis of safety profiling data. *Methods Mol. Biol.* **575**, 207–223.
- Scheiber, J., Jenkins, J. L., Sukuru, S. C., Bender, A., Mikhailov, D., Milik, M., Azaoui, K., Whitebread, S., Hamon, J., Urban, L., Glick,

- M., and Davies, J. W. (2009) Mapping adverse drug reactions in chemical space. *J. Med. Chem.* 52, 3103–3107.
46. Azzaoui, K., Hamon, J., Faller, B., Whitebread, S., Jacoby, E., Bender, A., Jenkins, J. L., and Urban, L. (2007) Modeling promiscuity based on in vitro safety pharmacology profiling data. *ChemMedChem* 2, 874–880.
47. Scheiber, J., Chen, B., Milik, M., Sukuru, S. C., Bender, A., Mikhailov, D., Whitebread, S., Hamon, J., Azzaoui, K., Urban, L., Glick, M., Davies, J. W., and Jenkins, J. L. (2009) Gaining insight into off-target mediated effects of drug candidates with a comprehensive systems chemical biology analysis. *J. Chem. Inf. Model.* 49, 308–317.
48. Iorio, F., Bosotti, R., Scacheri, E., Belcastro, V., Mithbaokar, P., Ferriero, R., Murino, L., Tagliaferri, R., Brunetti-Pierri, N., Isacchi, A., and di Bernardo, D. (2010) Discovery of drug mode of action and drug repositioning from transcriptional responses. *Proc. Natl. Acad. Sci. U.S.A.* 107, 14621–14626.
49. Lamb, J. (2007) The Connectivity Map: A new tool for biomedical research. *Nat. Rev.* 7, 54–60.
50. Lamb, J., Crawford, E. D., Peck, D., Modell, J. W., Blat, I. C., Wrobel, M. J., Lerner, J., Brunet, J. P., Subramanian, A., Ross, K. N., Reich, M., Hieronymus, H., Wei, G., Armstrong, S. A., Haggarty, S. J., Clemons, P. A., Wei, R., Carr, S. A., Lander, E. S., and Golub, T. R. (2006) The Connectivity Map: Using gene-expression signatures to connect small molecules, genes, and disease. *Science* 313, 1929–1935.
51. DeGraw, A. J., Keiser, M. J., Ochocki, J. D., Shoichet, B. K., and Distefano, M. D. (2010) Prediction and evaluation of protein farnesyltransferase inhibition by commercial drugs. *J. Med. Chem.* 53, 2464–2471.
52. Fontanilla, D., Johannessen, M., Hajipour, A. R., Cozzi, N. V., Jackson, M. B., and Ruoho, A. E. (2009) The hallucinogen N,N-dimethyltryptamine (DMT) is an endogenous  $\sigma$ -1 receptor regulator. *Science* 323, 934–937.
53. Su, T. P., Hayashi, T., and Vaupel, D. B. (2009) When the endogenous hallucinogenic trace amine N,N-dimethyltryptamine meets the  $\sigma$ -1 receptor. *Sci. Signaling* 2, No. pe12.
54. Smith, R. L., Canton, H., Barrett, R. J., and Sanders-Bush, E. (1998) Agonist properties of N,N-dimethyltryptamine at serotonin 5-HT<sub>2A</sub> and 5-HT<sub>2C</sub> receptors. *Pharmacol., Biochem. Behav.* 61, 323–330.
55. Kohlen, R., Metcalf, M. A., Khan, N., Druck, T., Huebner, K., Lachowicz, J. E., Meltzer, H. Y., Sibley, D. R., Roth, B. L., and Hamblin, M. W. (1996) Cloning, characterization, and chromosomal localization of a human 5-HT<sub>6</sub> serotonin receptor. *J. Neurochem.* 66, 47–56.
56. Pierce, P. A., and Peroutka, S. J. (1989) Hallucinogenic drug interactions with neurotransmitter receptor binding sites in human cortex. *Psychopharmacology (Berlin, Ger.)* 97, 118–122.
57. Wyllie, J. H., Hesselbo, T., and Black, J. W. (1972) Effects in man of histamine H<sub>2</sub>-receptor blockade by burimamide. *Lancet* 2, 1117–1120.
58. Kokel, D., Bryan, J., Laggner, C., White, R., Cheung, C. Y., Mateus, R., Healey, D., Kim, S., Werdich, A. A., Haggarty, S. J., Macrae, C. A., Shoichet, B., and Peterson, R. T. (2010) Rapid behavior-based identification of neuroactive small molecules in the zebrafish. *Nat. Chem. Biol.* 6, 231–237.
59. Rihel, J., Prober, D. A., Arvanites, A., Lam, K., Zimmerman, S., Jang, S., Haggarty, S. J., Kokel, D., Rubin, L. L., Peterson, R. T., and Schier, A. F. (2010) Zebrafish behavioral profiling links drugs to biological targets and rest/wake regulation. *Science* 327, 348–351.
60. Young, D. W., Bender, A., Hoyt, J., McWhinnie, E., Chirn, G. W., Tao, C. Y., Tallarico, J. A., Labow, M., Jenkins, J. L., Mitchison, T. J., and Feng, Y. (2008) Integrating high-content screening and ligand-target prediction to identify mechanism of action. *Nat. Chem. Biol.* 4, 59–68.
61. Liu, T., Lin, Y., Wen, X., Jorissen, R. N., and Gilson, M. K. (2007) BindingDB: A web-accessible database of experimentally determined protein-ligand binding affinities. *Nucleic Acids Res.* 35, D198–D201.
62. Roth, B. L., Kroeze, W. L., Patel, S., and Lopez, E. (2000) The Multiplicity of Serotonin Receptors: Uselessly diverse molecules or an embarrassment of riches? *Neuroscientist* 6, 10.
63. Rosenbaum, D. M., Cherezov, V., Hanson, M. A., Rasmussen, S. G., Thian, F. S., Kobilka, T. S., Choi, H. J., Yao, X. J., Weis, W. I., Stevens, R. C., and Kobilka, B. K. (2007) GPCR engineering yields high-resolution structural insights into  $\beta$ -adrenergic receptor function. *Science* 318, 1266–1273.
64. Altschul, S. F., Madden, T. L., Schaffer, A. A., Zhang, J., Zhang, Z., Miller, W., and Lipman, D. J. (1997) Gapped BLAST and PSI-BLAST: A new generation of protein database search programs. *Nucleic Acids Res.* 25, 3389–3402.