

The B→Z transition in two synthetic oligonucleotides: d(C-2-amino-ACGTG) and d(m⁵CGCAm⁵CGTGCG) studied by IR, NMR and CD spectroscopies

J.A.Taboury¹, S.Adam¹, E.Taillandier¹, J.-M.Neumann², S.Tran-Dinh², T.Huynh-Dinh³, B.Langlois d'Estaintot³, M.Conti³ and J.Igolen^{3*}

¹Laboratoire de Spectroscopie Biomoléculaire, UER Santé-Médecine Biologie Humaine, 74, rue Marcel-Cachin, 93012 Bobigny, Cedex, France

Received 16 May 1984; Revised and Accepted 18 July 1984

ABSTRACT

The sequences CA'CGTG (where A' = 2-aminodeoxyadenosine) and m⁵CGCAm⁵CGTGCG are prepared and studied by IR, CD and ¹H-NMR. Infrared spectra demonstrate the capacity of the modified hexamer and decamer to adopt a Z conformation. The influence of the NH₂ substitution on the adenine or of the methylated terminal part of the decamer acting with the increase of the DNA concentration stabilizes the Z conformation at room temperature in low humidity films. Very weak proportion of Z conformation is detected in UV dilute solutions. In more concentrated NMR solutions, the Z proportion induced by high salt content is only 20-25 %. The effects of the concentration and of the covalent modification of the bases are discussed.

INTRODUCTION

A small number of left-handed Z-DNA structures is known in crystals : the d(C-G)₃ hexamer with different cations (1-2), the d(C-G)₂ tetramer in its low salt form (3-4) and the methylated hexamer in d(m⁵C-G)₃ (5). It is theoretically possible that any purine pyrimidine sequence can adopt a left-handed structure but the perfectly alternating d(G-C)_n sequence appears the best one to potentiate the Z form. Two possible requirements for Z-DNA stabilization emerge from the three dimensional structure in the crystals of d(G-C)_n sequences : the presence of the purine 2-amino-group in guanine and of the methyl group on the C5 position of cytosine. A bridging water molecule between the aminoguanine group and a phosphate group would make the guanine more stable in the syn conformation than adenine (2-6). So, 2-aminoadenine should behave like guanine (6). On the other hand, the methylation of the cytosine acts in stabilizing Z-DNA through hydrophobic bonding (5). The present work was undertaken to test the aminoadenine and the 5-methylcytosine for their effects on the helix structure of short alternating sequences containing AT and GC base pairs.

The effect of 2-amino substitution in adenosine has been

examined in the $d(\text{TA}')_3$ hexanucleotide (where $\text{dA}' = 2\text{-aminodeoxyadenosine}$) (7) and in $d(\text{TA}')_n$ (8). The two deoxypolymers solutions exhibit, at high NaCl concentration, CD spectra which have been interpreted as indicative of a possible left-handed conformation. However, the CD spectra characterized by a 278 nm negative band remain different from those recorded with $d(\text{G-C})_n$ in the Z form. The Z form of poly $d(\text{A-m}^5\text{C})$. $d(\text{G-T})$ has been well demonstrated by UV, Raman spectroscopies and NMR (9). However the stabilization of the Z form in the methylation polymer solutions requires not only high NaCl content but also high temperature.

We have prepared two self complementary sequences, the $d(\text{CA}'\text{CGTG})$ hexamer and the $d(\text{m}^5\text{CGAm}^5\text{CGTGCG})$ decamer. The conformations of the two short DNA fragments have been investigated by infrared spectroscopy, CD spectroscopy and NMR. We have obtained the infrared data characteristic of the Z form for the hydrated films of these two oligonucleotides at room temperature, in the absence of high NaCl content. A comparison between the results obtained by IR spectroscopy on films and the results on diluted solutions by UV spectroscopy or on more concentrated solutions by NMR allows to discuss the influence of the DNA concentration on the equilibrium between the B form and the Z form.

MATERIALS AND METHODS

The 2-aminodeoxyadenosine was prepared by aminolysis of 1,2,4-triazolo-deoxyguanosine (10). The hexamer and decamer were prepared from dimers (scheme 1 and 2), deblocked and purified according to published literature (11,12).

For the IR studies, the oligomer solutions (500 μl) are dialysed against NaCl solutions so as to obtain finally 1 NaCl in excess per nucleotide in the sample. Small amounts of NaOH were added to adjust the pH at 7-8. The solutions are then deposited on an infrared ZnSe support and gently dried to obtain films. These films are placed in sealed cells with controlled atmosphere. The relative humidity of the atmosphere which determines the hydratation of the sample is monitored by introducing vessels with different saturated salts (R.H. between 15 and 98 %, H_2O or D_2O). IR spectra of the films are recorded using a 180 Perkin-Elmer spectrophotometer (temperature 35°C). Digital data issued by the ratiometer are directly treated by a Hewlett Packard 9825A computer allowing base line corrections for water contributions. The spectral band width is adjusted to 2 cm^{-1} between 1850 cm^{-1} and 550 cm^{-1} . For CD and UV spectro-

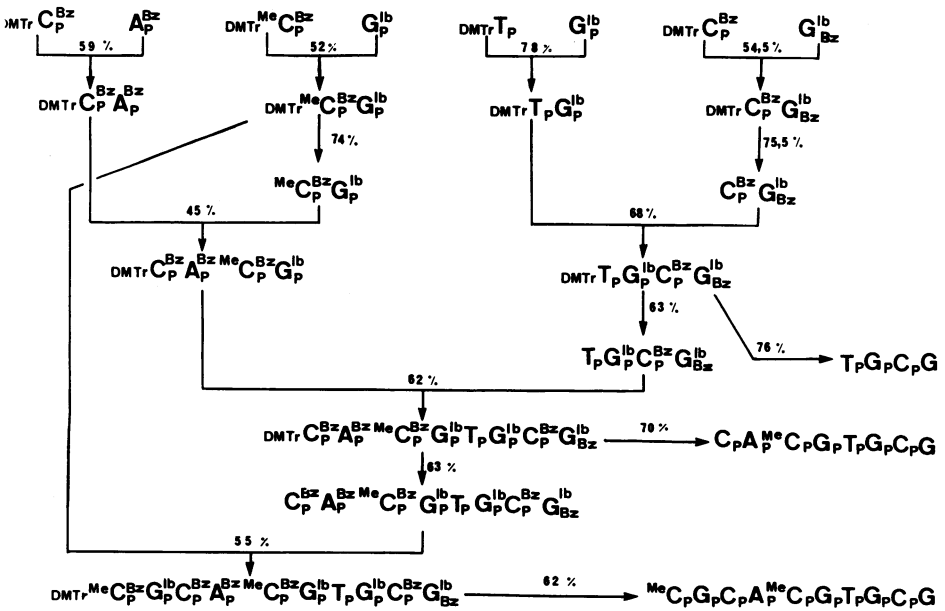
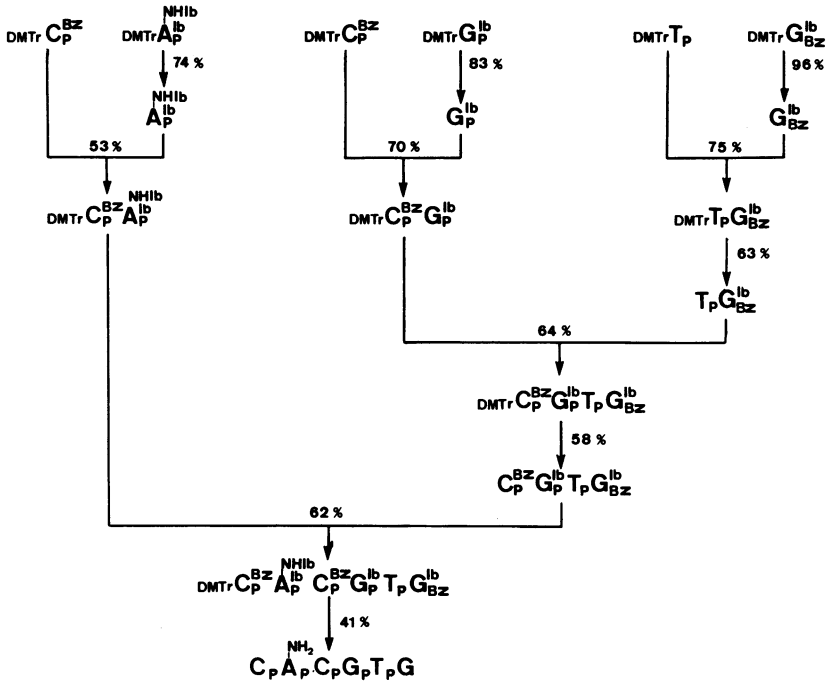

scopy, the oligomers are dissolved in 5 mM pH 7.5 phosphate buffer, 0.1 mM EDTA and 0.1 M to 5.5 M NaCl. UV spectra are obtained on a Cary 219 spectrophotometer and CD spectra on an autodichrograph Mark V (Jovin Yvon). For the $^1\text{H-NMR}$ experiments, all samples were dissolved in D_2O containing 0.1 M or 4 M NaCl + 5 mM PO_4^{2-} and were free of divalent cations by adding EDTA (≈ 0.1 mM). The pH was adjusted to 7-8 by addition of small amounts of NaOD. Samples were lyophilized twice in D_2O and redissolved in D_2O at a final concentration of 1-2 mM. All spectra were recorded on a Bruker WM 500 (500 MHz).

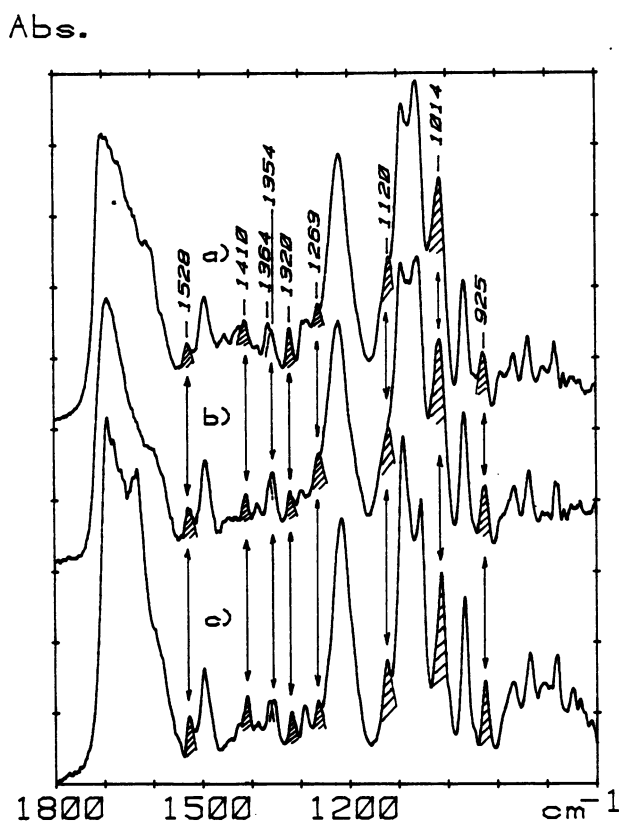

Figure 1 : Infrared spectra of the Z form with NaCl content of
a) $d(\text{CA}'\text{CGTG})$ where $\text{A}' = 2\text{-aminodeoxyadenosine}$;
b) $d(m^5\text{CGCA}m^5\text{CGTGCG})$;
c) $d(\text{G-C})_n$

RESULTS

Infrared results

Infrared spectra of the two deoxyoligomers $d(\text{CA}'\text{CGTG})$ and $d(\text{m}^5\text{CGCAm}^5\text{CGTGCG})$ are shown in Fig. 1(a), Fig. 1(b) between 1800 cm^{-1} and 700 cm^{-1} , partly with a higher expansion between 1550 cm^{-1} and 1250 cm^{-1} in Fig. 2(a), Fig. 2(b) and between 1030 cm^{-1} and 700 cm^{-1} in Fig. 3(a), Fig. 3(b) (Figure 3, the samples are deuterated). These IR spectra are obtained at a relative humidity of 76 % for the hexamer and 66 % for the decamer, with a salt content of the film samples corresponding to 1 NaCl in excess per nucleotide. They are closed to those obtained for $d(\text{G-C})_n$ in the Z form Fig. 1(c), Fig. 2(c), Fig. 3(c) and are thus typical of the Z structure. With sodium chloride counterions the spectrum of the Z form is observed at about 93 % and at lower relative humidities whereas a spectrum of the B form is observed at relative

Abs.

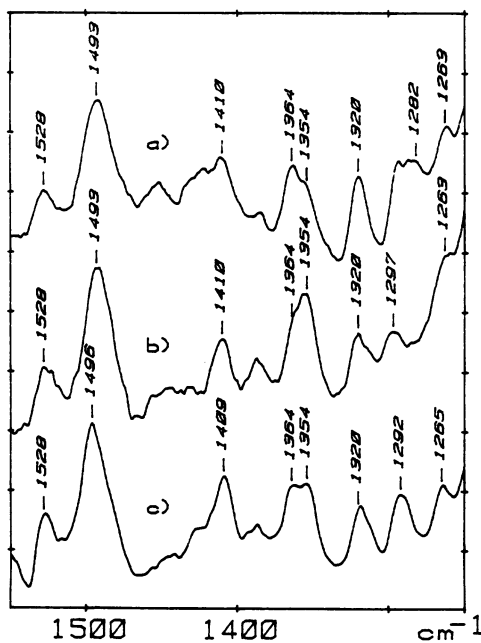

Figure 2 : Infrared spectra of the Z form with higher expansion between $1550\text{--}1250\text{ cm}^{-1}$ of

- a) $d(\text{CA}'\text{CGTG})$;
- b) $d(\text{m}^5\text{CGCAm}^5\text{CGTGCG})$;
- c) $d(\text{G-C})_n$

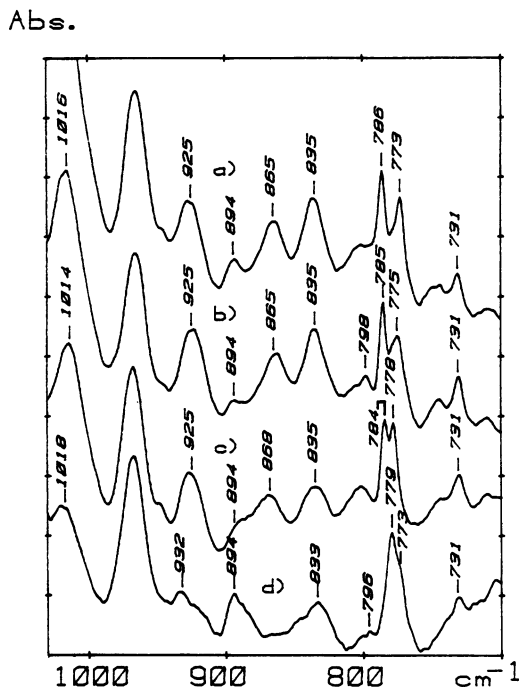

Figure 3 : Infrared spectra of the Z form in the 1030-700 cm^{-1} region of the deuterated
 a) $\text{d}(\text{CA}'\text{CGTG})$;
 b) $\text{d}(\text{m}^5\text{CGCAm}^5\text{CGTGCG})$;
 c) $\text{d}(\text{G-C})_n$
 d) Infrared spectrum of the B form in the 1030-700 cm^{-1} region of the deuterated $\text{d}(\text{m}^5\text{CGCAm}^5\text{CGTGCG})$

humidities higher than 93 % Fig. 4(a), Fig. 4(b). The infrared data show that $\text{d}(\text{CA}'\text{CGTG})$ and $\text{d}(\text{m}^5\text{CGCAm}^5\text{CGTGCG})$ undergo the B \rightarrow Z transition when the relative humidity of the films decreases.

We will now describe in detail the spectral features characteristic of the B \rightarrow Z transition which are observed in the case of $\text{d}(\text{CA}'\text{CGTG})$ and $\text{d}(\text{m}^5\text{CGCAm}^5\text{CGTGCG})$ as in the case of $\text{d}(\text{G-C})_n$. In the region of the intense infrared absorptions of the bases between 1750 cm^{-1} and 1500 cm^{-1} , a stretching mode of the carbonyl group of the guanine situated at 1710 cm^{-1} in the B form (Fig. 4(a), Fig. 4(b), Fig. 4(c)) is shifted to 1693 cm^{-1} in the Z form. Simultaneously a decrease in the intensity of the 1528 cm^{-1} band is observed (Fig. 1(a), Fig. 1(b), Fig. 1(c)). The shift of the 1710 cm^{-1} band can be explained by large

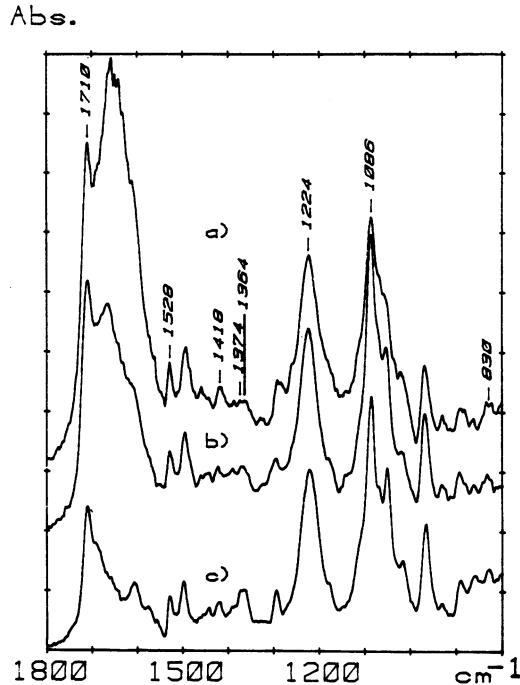

Figure 4 : Infrared spectra of the B form in the 1800-800 cm^{-1} region of
 a) $d(\text{CA}^1\text{CGTC})$;
 b) $d(\text{m}^5\text{CGCAm}^5\text{CGTGCG})$;
 c) $d(\text{G-C})_n$

differences in base stacking between B and Z forms (13-14). An other infrared band of the guanine is shifted from 1420 cm^{-1} at high humidity (B form Fig. 4) to 1410 cm^{-1} at low humidity (Z form Fig. 2). Two new IR bands appear in the low humidity spectra at 1320 cm^{-1} and near 1265 cm^{-1} (Z form Fig. 2). A doublet is observed at 1364 cm^{-1} - 1354 cm^{-1} in the Z form (Fig. 2). The band at 1354 cm^{-1} (Z form) is due to a guanine vibration coupled to the glycosidic bond stretching, thus its frequency varies from 1374 cm^{-1} (B form) to 1354 cm^{-1} (Z form) depending upon whether the glycosidic linkage is syn or anti (15). The unshifted component of the doublet at 1364 cm^{-1} is due to the dC residue which remains in the anticonformation. The same vibration is located at 1356 cm^{-1} for the methylated cytosine, thus, the guanine and the methylated cytosine contributions overlap in the Z form spectrum of the decamer Fig. 2(b). In the region of the sugar absorption bands, an

intense absorption appears at 925 cm^{-1} in the low humidity spectra Fig. 3(a), Fig. 3(b), Fig. 3(c). The bands near 1015 cm^{-1} and 1122 cm^{-1} are considerably enhanced. These bands are mainly due to the sugar ring possibly coupled to C-O and C-C stretching of the phosphodiester linkage. The enhancement may be due to the interaction between the oxygen of the sugar ring and the purine residue which are stacked in the Z form (2). The IR bands of the region $800\text{--}900\text{ cm}^{-1}$ show the same dependence on helix conformation for $d(\text{CA}'\text{CGTG})$, $d(\text{m}^5\text{CGCAm}^5\text{CGTGCG})$ and $d(\text{GC})_n$. The decrease in the intensity of the 894 cm^{-1} band is observed at low humidities (Fig. 3(a), Fig. 3(b), Fig. 3(c)). The low humidity spectra have two bands near 865 cm^{-1} and at 835 cm^{-1} instead of one band at 835 cm^{-1} in the B form spectrum Fig. 3(d). In heavy water, the Z form of $d(\text{G-C})_n$ presents a doublet at 784 cm^{-1} and 778 cm^{-1} . These two infrared bands are attributed to out of plane vibration of guanine and cytosine. The C band at 778 cm^{-1} is unshifted but the G band is shifted from 778 cm^{-1} to 784 cm^{-1} during the B \rightarrow Z transition (15-16). The methylated cytosine absorption is found at 768 cm^{-1} (15-16). The low humidity spectra of the hexamer and of decamer exhibit also a doublet respectively at $786\text{--}773\text{ cm}^{-1}$ and at $785\text{--}775\text{ cm}^{-1}$ (Fig. 3(a), Fig. 3(b)). However this spectral region is complicated by the absorption bands of the two AT base pairs. Infrared bands occur at 775 cm^{-1} for the thymine and 798 cm^{-1} for the adenine (790 cm^{-1} for the 2 amino adenine). The T band and C band are overlapped but the G band near 784 cm^{-1} remains a marker of the Z conformation of $d(\text{CA}'\text{CGTG})$ and $d(\text{m}^5\text{CGCAm}^5\text{CGTGCG})$. The guanine ring breathing related to the Raman line at 684 cm^{-1} in B form and 621 cm^{-1} in Z form (17), corresponds to a too weak infrared absorption to be detected. However, the peak to peak survey of the IR spectra shows unambiguously that the low humidity form of the hexamer and of the decamer can be described to the Z DNA structures.

We have also recorded the IR spectra of the $d(\text{CACGTG})$ films with NaCl content. (spectra not shown). No evidence of the B-Z transition has been detected by lowering the hydration of the samples.

CD results

The conformation of $d(\text{CA}'\text{CGTG})$ and $d(\text{m}^5\text{CGCAm}^5\text{CGTGCG})$ were also investigated by CD spectroscopy. Figure 5 and figure 6 present the CD studies of the two sequences for low and high NaCl concentrations. This type of spectrum is mainly assigned to a B conformation by comparison with those obtained for other oligomers and polymers (18-19). For $d(\text{CA}'\text{CGTG})$,

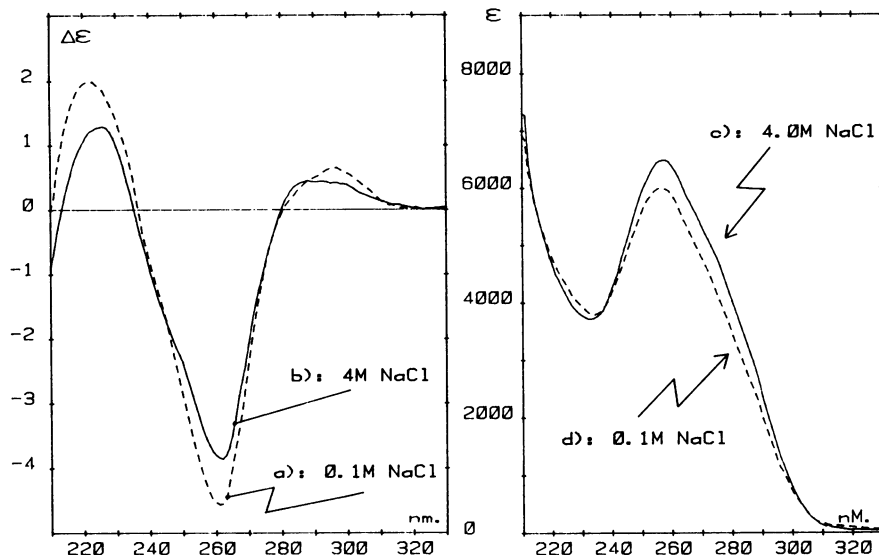

Figure 5 : CD spectra of d(CA'CGTG) for low and high NaCl concentrations
 a) 0.1 M NaCl ;
 b) 4 M NaCl ;
 UV spectra of the same sequence at
 c) 4 M NaCl
 d) 0.1 M NaCl

no direct evidence for Z conformation is obtained at any NaCl concentration even at low temperature (2°C) as shown Fig. 5(b). However a small decrease of the ellipticity at 295 nm is observed at high NaCl concentration in the case of d(m⁵CGCm⁵CGTGCG) Fig. 6(a), Fig. 6(b). Thus a very weak proportion of Z conformation would be in equilibrium with the predominant B form for the decamer.

¹H-NMR studies

d(CA'CGTG) : Fig. 7(a) shows the 500 MHz ¹H-NMR spectrum of the base protons of d(CA'CGTG) in 0.1 M NaCl solution at 22°C. The proton resonance assignments were established by comparison with d(CACGTG) and d(CG TG) (11) and by NOE measurements. The H₈ resonance of 2-aminoadenine (A') is located at about 8.0 ppm instead of 8.3-8.4 ppm for the unmodified adenine indicating that the ring current of the first base is slightly smaller than that of the second one. Apart from the H₈ proton of dA', the base proton resonances of the other residues exhibit practically the same chemical shifts as those of d(CACGTG) at the same temperature (22°C)

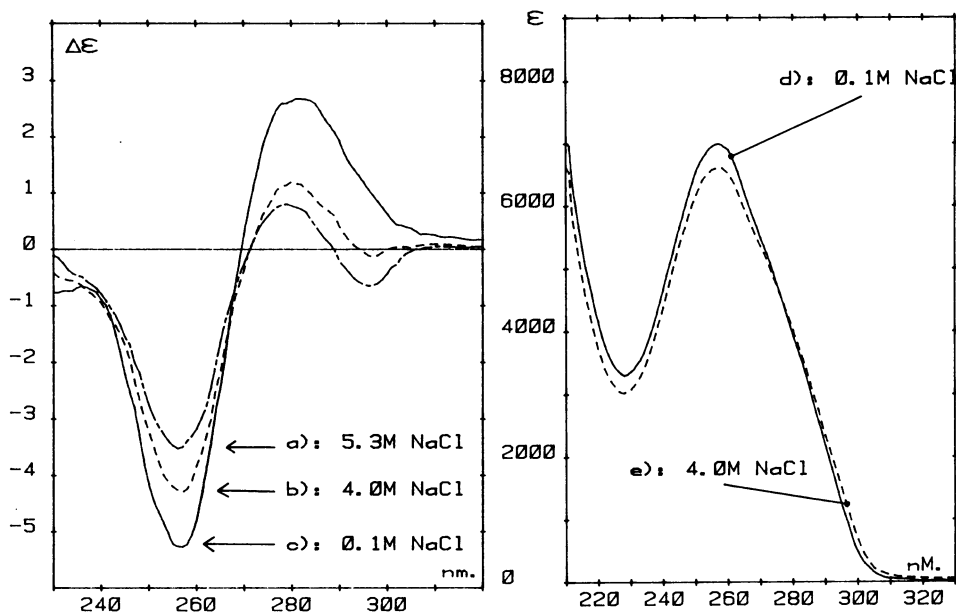

Figure 6 : CD spectra of $d(m^5CGCAm^5CGTGCG)$ at
 a) 5.3 M NaCl ;
 b) 4.0 M NaCl ;
 c) 0.1 M NaCl ;
 UV spectra of the same sequence at
 d) 0.1 M NaCl
 e) 4.0 M NaCl

where only the B form is present (11).

Figure 7(b) shows the 500 MHz 1H -NMR spectrum of the $d(CA'CGTG)$ base protons in 4 M NaCl solution at 21°C. As in the case of $d(m^5CGCGm^5CG)$ (20) and $d(CGm^5CGCG)$ (21,22), two resonance signals were observed for each proton. This demonstrates that two double helical forms are present in solution and the exchange between them is relatively slow. The resonances corresponding to the B form were easily identified by comparison with the spectrum obtained at 0.1 M NaCl Fig. 7(a). The additional signals were then attributed to the Z form on the bases of chemical shift consideration.

- i) The CH_3 signal of dT in the Z form is observed at the highest field ($\delta = 1.1$ ppm), very far from the B form signal ($\delta = 1.5-1.9$ ppm) owing to the strong ring current effect from the following dG residue characteristic of the Z conformation (20).
- ii) The dG H_β resonances of the Z form are located at about 7.8 ppm i.e. 0.10-0.15 ppm upfield from those of the B form. These characteristics of the Z form spectra have been

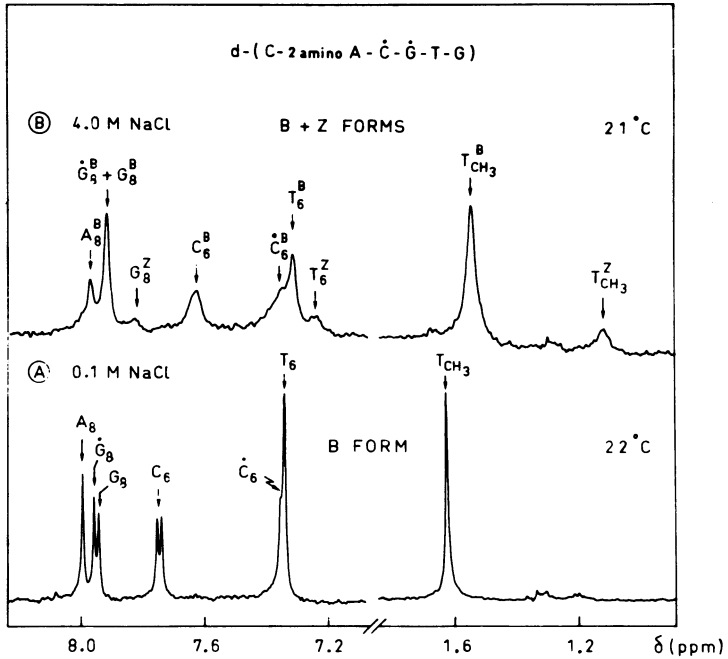

Figure 7 : 500 MHz base protons spectra of d-(C-2-amino A-C-G-T-G) (A) in 0.1 M NaCl solution ; (B) in 4 M NaCl solution.

observed for d(m⁵CGCGm⁵CG) (20) and d(CGm⁵CGCG) (21). At room temperature the coil proportion is negligible, the proportions of B and Z can thus be determined by integrating the methyl signal in Fig. 7(B) : we found that at 21°C the Z proportion is only about 22 ± 3 %, much smaller than that observed for d(m⁵CGCGm⁵CG) (20) and d(CGm⁵CGCG) (22) (≈ 100 % at 4 M NaCl).

d(m⁵CGCAm⁵CGTGCG) : Figure 8(a) shows the base proton spectrum of the B form in low salt concentration (0.1 M NaCl) and at 46°C where the coil proportion is negligible ($t_{1/2} \approx 85^\circ\text{C}$). The proton assignment was performed by comparison with the B form proton spectra of d(CAm⁵CGTGCG), d(TGCG), d(m⁵CGCGm⁵CG), d(CGm⁵CGCG) and d(CACGTG) and by the methods described in our previous papers (20). Figure 8(b) shows the base proton spectrum of the decamer in 4 M NaCl solution. In the 7.0-8.3 ppm region, the signals of the B and Z forms overlap and the Z signals were determined by the polarisation transfer method (between B and Z). By contrast, in the 1.1-2.0 ppm region, the methyl resonances of B and Z are well separated.

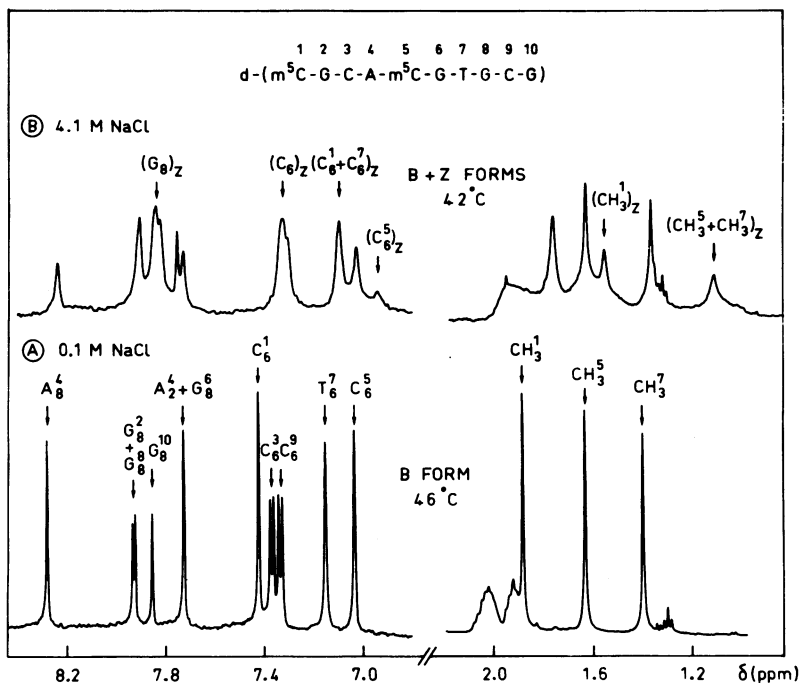

Figure 8 : 500 MHz base protons spectra of d-(m⁵C-G-C-A-m⁵C-G-T-G-C-G) **(A)** in 0.1 M NaCl solution; **(B)** in 4 M NaCl solution.

The CH₃(Z) signals are located at in higher field region than the corresponding signals of B. The CH₃(Z) resonances of the central m⁵dC and internal dT coincide and are situated at the same position as those of d(m⁵CGCGm⁵CG), d(CGm⁵CGCG) and d(CA'CGTG) in the Z form. From integration of the B and Z methyl signals, the Z proportion was found to be about 25 % at 42°C. It should be pointed out that under the same temperature and salt (4 M NaCl) conditions, the Z proportion is highly predominant (≈ 100 %) for shorter d(CG)_n sequences containing one or two m⁵dC residues e.g. d(m⁵CGCGm⁵CG), d(CGm⁵CGCG) and d(CGm⁵CG).

DISCUSSION

With regard to the IR, CD and RMN data, the immediate and striking result is that the proportion of the Z form strongly depends on the experimental conditions. The IR results clearly show that the Z form is highly predominant at low humidity. By contrast, only 25 % of Z conformation is observed in high salt solution (4 M NaCl) using the NMR technic while no evidence for the presence of the Z form is obtained at any

salt concentration when using the CD one. The discrepancy between the CD, NMR and IR data can be explained by the mechanism of the Z-B-coil transition in NaCl solution reported recently on methylated d(CG)_n oligomers (20,22). We showed that Z only exchanges with B, while the latter also exchanges with the single stranded form (coil) : $Z \rightleftharpoons B \rightleftharpoons \text{coil}$. The B → Z transition in solution is only possible when the Watson-Crick hydrogen bonds between the base pairs are firmly maintained, otherwise the B helix → coil transition would occur instead. The B helix-coil dissociation constant K_d depends on the deoxyoligomer concentration C ($K_d = \frac{2\alpha^2 C}{1-\alpha}$ where α is the coil proportion). The oligomer concentration used in the CD technic is very small (about 10 μM in single-stranded concentration) compared with that used for the NMR studies (1-2 mM in single-stranded concentration). The Z form is thus more favoured in the IR films and the NMR solutions than in the CD solutions in agreement with the above model for the $Z \rightleftharpoons B \rightleftharpoons \text{coil}$ transitions. In addition, it is well known that aggregation, much larger in NMR than in CD experiments has the effect to stabilize the Z conformation because of its hydrophobic character (23).

The IR data indicate that the films of d(CA⁵CGTG) and d(m⁵CGCAm⁵CGTGCG) behave likely to the d(G-C)_n films. The B → Z transition takes place by deshydration. We found that if the films of the hexamer and decamer, at room temperature, with a content of 1 Na⁺ per nucleotide are 100 % hydrated their spectra are of the B type whereas the Z type infrared spectra are obtained below 93 % relative humidity. In the first crystalline experiments, the crystals are formed from a low salt solution (1-2). CD measurements of this solution indicate no Z-DNA present, a small number of Z DNA molecules is in equilibrium with B DNA molecules in the solution but the crystals that formed were entirely Z-DNA. In the low humidity films the equilibrium may be shifted in favor of the hydrophobic Z form as in the crystals.

In contrast with the covalently modified hexamer and decamer films, the unmodified hexamer d(CACGTG) films fail to undergo the B → Z transition at low humidity. We have also recently observed that Ni²⁺ cations but not Na⁺ are able to induce the Z conformation in low humidity poly d(A-C). poly d(G-T) films (24). Thus NH₂ and CH₃ substitution have favoured the Z conformation in presence of Na⁺ cations. It has been proposed (5) that the methyl group on the C-5 position of cytosine acts by forming hydrophobic regions in the major groove where it is largely surrounded by water molecules in the B double helix. We found

that the increase of the hydrophobic character of the sequence and the condensed state of the sample contribute to induce the B → Z transition of the decamer at room temperature and low Na⁺ content. In addition, it is possible that the d(m⁵CGC) terminal parts of the decamer would force the central part containing the two AT base pairs in the Z form with a sufficient efficiency due to the two methylated cytosines.

The 2-amino substitution in adenine permits formation of three hydrogen bonds. The fact that the B → Z transition takes place in double helix when the Watson-Crick hydrogen bonds are maintained (20) means that this third hydrogen bond favours the Z conformation. In addition a stabilizing contribution of the adenine syn conformation may be due to a bridging water molecule, between the amino group of the base and the adjacent phosphate group as it has been proposed (2-6). The effects of the 2-amino substitution in adenine with those of the high DNA concentration act to induce the Z conformation of the d(CACGTG) sequence.

The replacement of adenine by amino adenine is not frequent in the nature, it is however found in cyanophage (25) and the methylation of the cytosine occurs quite frequently in eukaryotic DNA. Our results show that the presence of three hydrogen bonds between the 2-amino A and T or the methylation of one of the two or three adjacent GC pairs are sufficient to force the AT pairs into the Z structure in condensed phases. As the Z conformation is stabilized under physiological conditions of temperature and salt content, possible biological relevance is suggested.

²Service de Biophysique, Centre d'Etudes Nucléaires de Saclay, 91191 Gif-sur-Yvette, Cedex, France

³Unité de Chimie Organique, Département de BGM, ERA-CNRS 927, Institut Pasteur, 28, rue du Docteur-Roux, 75724 Paris, Cedex 15, France

*To whom correspondence should be addressed

REFERENCES

1. Wang, A.H.J., Quigley, G.J., Kolpak, F.J., Crawford, J.L., Van Boom, J.H., Van der Marel, G. and Rich, A. (1979) *Nature* 282, 680-686.
2. Wang, A.H.J., Quigley, G.J., Kolpak, F.J., Van der Marel, G., Van Boom, J.H. and Rich, A. (1981) *Science* 211, 171-176.
3. Drew, H.R., Takano, T., Tanaka, S., Itakura, A. and Dickerson, R.E. (1980) *Nature* 286, 567-572.
4. Drew, H. and Dickerson, R.E. (1981) *J. Mol. Biol.* 152, 723-736.
5. Fujii, D., Wang, A.H.J., Van der Marel, G., Van Boom, J.H. and Rich, A. (1982) *Nucleic Acids Res.* 10, 7879-7892.
6. Dickerson, R.E., Drew, H.R., Conner, B.N., Wing, R.M., Fratini, A.V. and Kopka, M.L. (1982) *Science* 216, 475-485.

7. Gaffney, B.L., Marky, L.A. and Jones, R.A. (1982) *Nucleic Acids Res.* 10, 4351-4361.
8. Howard, F.B., Chen, C.W., Cohen, J.S. and Todd Miles, H. (1984) *Biochem. Biophys. Res. Comm.* 118, 848-853.
9. Mc Intosh, L.P., Grieger, I., Eckstein, F., Zerling, D.A., Van de Sande, J.H. and Jovin, T.M. (1983) *Nature* 304, 83-86.
10. Reese, C.B. and Ubasawa, A. (1980) *Nucleic Acids Res. Symposium Series 7*, Koster Ed., 5-21.
11. Tran-Dinh, S., Neumann, J.-M., Taboury, J., Huynh-Dinh, T., Renous, S., Genissel, B. and Igolen, J. (1983) *Eur. J. Biochem.* 133, 579-589.
12. Barnett, R.W. and Letsinger, R.L. (1981) *Tetrahedron Lett.* 22, 991-994.
13. Taillandier, E., Taboury, J., Liquier, J., Santière, P. and Couppez, M. (1981) *Biochimie* 63, 895-898.
14. Pilet, J. and Leng, M. (1982) *Proc. Natl. Acad. Sci. USA*, 79, 26-30.
15. Ghorni, M., Taboury, J.A. and Taillandier, E. (1984) *Biochimie* 66, 43-48.
16. Chinsky, L., Jollès, B., Laigle, A., Turpin, P.Y., Taboury, J.A., Taillandier, E. *Biopolymers* (in the press).
17. Thamann, T.J., Lord, R.C., Wang, A.H.J., Rich, A. (1981) *Nucleic Acids Res.* 9, 5443-5457.
18. Pohl, F.M. and Jovin, T.M. (1972) *J. Mol. Biol.* 67, 375-396.
19. Behe, M. and Felsenfeld, G. (1981) *Proc. Natl. Acad. Sci. USA* 73, 1619-1623.
20. Tran-Dinh, S., Taboury, J., Neumann, J.-M., Huynh-Dinh, T., Genissel, B., Langlois d'Estaintot, B. and Igolen, J. (1984) *Biochemistry* 23, 1362-1371.
21. Giessner-Prettre, C., Pullman, B., Tran-Dinh, S., Neumann, J.-M., Huynh-Dinh, T. and Igolen, J. (1984) *Nucleic Acids Res.* 12, 3271-3280.
22. Cavaillès, J.A., Neumann, J.-M., Taboury, J., Langlois d'Estaintot, B., Huynh-Dinh, T., Igolen, J. and Tran-Dinh, S. (1984) *J. Biomol. Str. and Dyn.* 1, 1347-1371.
23. Hartmann, B., Thanh-Thuong, N. Pouyet, J., Ptak, M. and Leng, M. (1983) *Nucleic Acids Res.* 11, 4453-4466.
24. Taillandier, E., Taboury, J., Adam, S., Liquier, J. (1984) (in preparation).
25. Kirnos, M.D., Khudyakov, I.Y., Alexandrushkina, N.I. and Vanyushin, B.R., (1977) *Nature* 270, 369-370.