Characterisation of bacterial clones containing DNA sequences derived from *Xenopus laevis* vitellogenin mRNA

Deborah F. Smith[†], Peter F. Searle and Jeffrey G. Williams*

National Institute for Medical Research, The Ridgeway, Mill Hill, London, NW7 1AA and *Imperial Cancer Research Fund, Burtonhole Lane, Mill Hill, London, NW7 1AD, UK

Received 15 December 1978

ABSTRACT

A 1700 nucleotide DNA sequence derived from *Xenopus vitellogenin* mRNA has been cloned in the bacterial plasmid pBR322. The identity of the cloned sequence was verified in two ways. Firstly, the plasmid DNA was shown to hybridise to an RNA of the correct size (6,700 nucleotides). This was shown by *in situ* hybridisation to electrophoretically separated RNA and also by the formation of "R-loops" with purified vitellogenin mRNA. Then, using a novel procedure in which plasmid DNA covalently bound to diazotised paper is used to select complementary mRNA sequences, the cloned sequence was shown to hybridise to an mRNA which directed the synthesis of vitellogenin when translated in a reticulocyte lysate cell-free system.

INTRODUCTION

The oestrogen-induced synthesis of vitellogenin in *Xenopus laevis* liver is a most advantageous system for the investigation of the hormonal control of eukaryotic gene expression (1,2,3). Synthesis of this large egg yolk protein precursor molecule can be induced both *in vivo* (4,5,6) and *in vitro* (7,8). Isolation of vitellogenin messenger RNA has proved to be relatively easy, due to its large size (6700 nucleotides) and high abundance (0.5 - 1% of total cytoplasmic RNA at maximum hormonal response) (9,10). The synthesis of a complementary DNA from the messenger RNA has allowed measurement of the induction of vitellogenin mRNA sequences during primary and secondary responses to oestrogen (11,12). However, for many kinds of experiment, it would be advantageous to use DNA cloned in a bacterial plasmid. We have therefore constructed bacterial plasmids containing DNA sequences (cDNAs) derived from up to 25% of the length of the vitellogenin mRNA.

We have used a procedure designed to increase the proportion of vitellogenin sequences in the RNA prior to cloning. Thus we made a cDNA copy of a population of mRNA containing vitellogenin mRNA as the predominant species and selected the cDNA fraction which hybridised most rapidly with

the RNA used for its synthesis. We then inserted this abundant cDNA into a bacterial plasmid and selected those bacterial clones which gave the strongest signal in an in situ hybridisation (13). The clone giving the strongest hybridisation signal contained the longest cDNA insert (1700 nucleotides) and this was located 650 nucleotides from the 3' end. This insert was shown to be a vitellogenin sequence by the following criteria:- (a) The plasmid DNA hybridised to an RNA of the size expected for vitellogenin mRNA in an in situ hybridisation using the procedure of Alwine et al. (14), and the plasmid DNA also formed "R-loops" with vitellogenin mRNA (15). (b) A new procedure for purifying mRNA sequences was developed in which plasmid DNA covalently bound to diazotised paper (14) was used to select for complementary mRNA sequences in total cytoplasmic RNA isolated from the livers of oestrogen-induced male Xenopus. Three different cloned sequences were tested and each DNA selected mRNA which, when translated in a reticulocyte lysate cell-free system, gave only vitellogenin polypeptides.

MATERIALS AND METHODS

Animals

Adult male Xenopus laevis (obtained from the South African Snake Farm, Fish Hoek, Cape Province, South Africa) were maintained at 18°C and fed chopped heart twice weekly. Synthesis of vitellogenin was stimulated by the subcutaneous implantation of 20 mg pellets of 17 β -oestradiol (Organon Labs. Ltd., Surrey, UK). For RNA preparations, animals were chilled and sacrificed by pithing.

Preparation of total cytoplasmic RNA

All buffer solutions were autoclaved at 15 p.s.i. for 15 min before use. All glassware was heated for 2 hr at 160°C.

Excised Xenopus liver was finely chopped and washed in ice-cold buffer (0.2 M Tris. HCl pH 8.5 at 4°C, 0.05 M KCl, 0.015 M MgCl₂) before homogenisation in 10 volumes of the same buffer using a motor-driven Potter-Elvehjem homogeniser with teflon pestle. The homogenate was centrifuged at 4°C for 5 min at 800 g, the supernatant decanted and made 1% in Triton X-100 and 200 μ g/ml in heparin. After centrifugation at 10,000 g for 10 min, SDS (1%) and Na₂ EDTA (10 mM) were added to the supernatant and the RNA extracted at room temperature using the phenol-chloroform procedure, described by Berridge et al. (16). RNA was stored at -80°C in sterile H₂O.

Isolation of total cytoplasmic poly(A)-containing RNA

Total cytoplasmic poly(A)-containing RNA was isolated by oligo(dT)-

cellulose chromatography. Total cytoplasmic RNA (approx. 200 A₂₆₀/ml) was made 1% in SDS and 30 mM in Na₂ EDTA and heated at 65°C for 5 min, followed by rapid cooling in ice-water. The RNA was then diluted to 2 A₂₆₀/ml and passed through oligo(dT)-cellulose (17) with the addition of NaCl to 0.5 M and Na₂ EDTA to 1 mM in the binding buffer.

Base cleavage and [³²P]-labelling of total cytoplasmic poly(A)-containing RNA

2.5 µg of total cytoplasmic poly(A)-containing RNA were incubated with 0.1 M NaOH (final concentration) for 60 min at 4°C to yield fragments of approximately 400 nucleotides in length, neutralised and ethanol precipitated in the presence of 70 mM NaCl. The recovered RNA, at 50 µg/ml in H₂O, was then incubated with γ-[³²P] ATP (100 µCi at >1500 Ci/mole (from The Radio-Chemical Centre, Amersham, IK); MgCl₂ (7 mM), Tris. HCl pH 7.6 (70 mM), β-mercaptoethanol (14 mM) and T₄ polynucleotide kinase (50 units/ml) for 1 hr at 37°C. Unincorporated ATP was removed by passage over a Sephadex G-50 column.

Analytical agarose gel electrophoresis

RNA and cDNA were electrophoresed in 1.5% agarose slab gels containing 5 mM methylmercuric hydroxide as a denaturing agent (18). RNA gels were prepared for transfer to DBM-paper as described by Alwine *et al.* (12). Plasmid DNA and restriction enzyme fragments were electrophoresed in 0.8% agarose slab gels containing boric acid pH 8.5 (89 mM), Tris (89 mM) and Na₂ EDTA (2.5 mM), or in 3.5% polyacrylamide gels, prepared according to the procedure of Maniatis *et al.* (19). All gels were stained with ethidium bromide (1µg/ml) and photographed under UV light, using Polaroid Type 55 film.

Preparation of complementary DNA

Complementary DNA was prepared by a slight modification of the procedure of Williams and Penman (20). The reaction mix (80µl) contained Tris HCl pH 8.3 (50mM), NaCl (60mM), DTT (10mM), MgAc₂ (6mM), actinomycin D (100 µg/ml) oligo dT₁₂₋₁₈ (5µg/ml), dATP, dGTP, TTP (0.5mM of each), [³H]dCTP, 200 mCi/mmole), total cytoplasmic poly(A)-containing RNA (100µg/ml) and AMV reverse transcriptase, 33 units (kindly supplied by Dr. J.W. Beard). Reaction was carried out at 40°C for 1 hr and the cDNA purified as previously described (20). Yield was approximately 2% (µg of cDNA per/µg of input RNA).

RNA excess hybridisations

Hybridisations were performed at 70°C in 0.24 M phosphate buffer (pH 6.8) containing SDS (0.02% and Na₂ EDTA (1 mM), as previously described (20). The amount of cDNA in hybrid form was determined using S₁ nuclease.

Isolation of abundant cDNA using hydroxyapatite

Hybridisation samples were diluted 1:5 to a final concentration of

0.12 M phosphate (pH 6.8) containing 0.2% SDS and applied to 400 mg of hydroxyapatite (HAP) in a jacketed column at 68°C. After washing with 2 vol. of the same buffer, double-stranded cDNA-mRNA hybrids were eluted from the column in 2 x 2 vol. of 0.48 M phosphate buffer (pH 6.8) containing 0.2% SDS. These fractions were pooled, desalted over a 40 x 2.5 cm Sephadex G-50 column equilibrated in TE buffer (10 mM Tris. HCl pH 7.4, 1 mM Na₂ EDTA) containing 0.1 M NaCl and ethanol precipitated in the presence of 100 µg wheat germ tRNA as carrier. After recovery by centrifugation, the RNA was hydrolysed for 2 hr at 37°C by the addition of NaOH to a final concentration of 0.3 M. The remaining cDNA was neutralised and reprecipitated from ethanol.

Synthesis of double-stranded cDNA

The abundant cDNA fraction recovered from HAP was made double-stranded using AMV reverse transcriptase. 200 ng of cDNA were incubated with Tris. HCl pH 8.3 (50 mM), DTT (20 mM), MgAc₂ (8 mM), dATP, dGTP, dCTP, TTP (all at 0.5 mM) and 35 units of reverse transcriptase for 4 hr at 46°C. After addition of salt to 0.1 M, the mix was sequentially extracted with phenol and chloroform and then, passed over a 20 x 1.5 cm G-50 column equilibrated in TE buffer. The excluded peak fractions were pooled and the extent of the reaction monitored by S₁ nuclease digestion.

S₁ nuclease digestion of double-stranded cDNA

Double-stranded cDNA (200 ng) was digested for 30 min at 21°C with 10⁴ units of S₁ nuclease (Boehringer) 10⁵ units/ml in a final volume of 2.5 ml of digestion buffer containing 0.28 M NaCl, 45 mM ZnSO₄, 30 mM NaAc (21). After sequential extraction with phenol and chloroform, the mix was passed over a 40 x 2.5 cm Sephadex G-50 column equilibrated with cacodylate buffer (10 mM cacodylic acid, 30 mM Tris. HCl pH 7.5) and the excluded peak fractions were pooled and lyophilised to a volume of about 1 ml.

Homopolymer tailing

Pst I-digested pBR322 DNA (2.5 µg) was incubated at 37°C in the presence of [³H] dGTP (sp. act. 4Ci/mmol), potassium cacodylate pH 7.5 (10 mM), DTT (0.1 mM), BSA (20 µg/ml), MgCl₂ (8 mM) and terminal transferase (the kind gift of Dr. P. Schedl). Double-stranded cDNA (5 ng) was incubated under similar conditions except that ³²P dCTP (4Ci/mmol) was used, CoCl₂ being the divalent cation. After 60 min, both reactions were terminated by the addition of EDTA to 20 mM and NaCl to 200 mM and then

sequentially extracted with phenol and chloroform, before passage over a 30 x 1 cm Sephadex G-50 column equilibrated in TE buffer.

Annealing reaction

Tailed plasmid DNA (2 µg/ml) and tailed double-stranded cDNA (5 µg/ml) were mixed in the ratio of 25:1, in a reaction volume of 200 µl TE buffer containing 0.2 M NaCl, and heated to 60°C for 2 hr. The mixture was then allowed to cool to room temperature overnight and divided into 2 x 100 µl aliquots for transformation.

Transformation

All manipulations were carried out in a Category 2 containment laboratory (22) as advised by the U.K. Genetic Manipulation Advisory Group. *E.coli* X 1776 (23) was grown at 37°C in 100 ml cultures of L Broth (1% bacto tryptone, 0.5% bacto yeast extract, 0.5% NaCl, 0.1% glucose) containing diaminopimelic acid (DAP, 100 µg/ml) and thymidine (5 µg/ml) to a density of 0.3 A₆₀₀/ml. The procedure for transformation was as described by Enea *et al.* (24), using 200 µl of cells with 100 µl of plasmid DNA (concentration <5 µg/ml) for each transformation. After incubation at 4°C for 60 min and a 2 min heat shock at 37°C, 0.5 ml L Broth/DAP/thymidine (as above) were added and the cells incubated for 30 min at 37°C. They were then plated onto L Broth agar plates containing DAP, thymidine and tetracycline (15 µg/ml)..

Drug screening

Recombinant colonies were screened for their resistance to tetracycline and ampicillin by replica-plating onto L Broth agar plates containing DAP, thymidine and either tetracycline (15 µg/ml) or ampicillin (100 µg/ml).

Colony hybridisation

The procedure used was a modification of the method of Grunstein and Hogness (25). Bacterial colonies were grown on nitrocellulose filters (Millipore HAWP, 9 cm), lysed in 0.5 M NaOH, neutralised in 1 M Tris. pH 7.5 and the cell debris firmly attached to the filters by the application of a hard vacuum from the water-driven pump. After washing with 96% ethanol, the filters were heated for 2 hr at 80°C. For hybridisation, the filters were incubated for 16 hr at 37°C in 8 ml of hybridisation buffer (50% formamide, 0.6 M NaCl, 1 mM EDTA, 0.1 M TES pH 7.4 (Sigma), 0.1% SDS and 25 µg/ml yeast tRNA) containing approximately 1 x 10⁶ cpm of [³²P]-labelled total cytoplasmic poly(A)-containing RNA. Filters were washed at 37°C for

4 x 1 hr in 2 x ssc (0.30 M NaCl, 30 mM Na citrate), 50% formamide; for 2 x 15 min in 2 x ssc; blotted dry and placed at -70°C with a preflashed Fuji X-ray film and a tungstate intensifying screen.

Isolation of plasmid DNA

Plasmid DNA was isolated by chloramphenicol amplification and lysis with Triton X-100, according to the method of Clewell and Helinski (26).

Procedure for Northern Transfer - Preparation of diazobenzoyloxymethyl paper

Nitrobenzoyloxymethyl (NBM) paper was prepared as described by Alwine *et al.* (14) using NBPC purchased from BDH Biochemicals Ltd. and stored at 4°C. Aminobenzoyloxymethyl (ABM) paper was prepared and converted to diazobenzoyloxymethyl (DBM) paper immediately prior to use. Sodium phosphate pH 6.5 (25 mM) was used in place of borate as buffer (14).

Transfer of RNA from gel to DBM paper

This was basically as described by Alwine *et al.* (14).

Hybridisation with cloned DNA

Plasmid DNA was nick-translated as described by Rigby *et al.* (27) to a specific activity of 5×10^7 cpm/ μ g. Prehybridisation of the DBM-paper and its subsequent hybridisation were as described by Alwine *et al.* (14) except that the concentration of salmon sperm DNA was 50 μ g/ml. The paper was washed 5 x 30 min at 34°C with formamide (50%), NaCl (20 mM), Na citrate (8 mM), Na₂ EDTA (1 mM) and SDS (0.2%), then twice with 2 x ssc; blotted dry and set up for autoradiography as described above.

Formation of R-loops and electron microscopy

Plasmid DNA was digested with B α mHI (which does not cut in the cloned insert) and sequentially extracted with phenol and chloroform. After ethanol precipitation the DNA was incubated at 50 μ g/ml with vitellogenin mRNA (purified on a sucrose gradient) also at 50 μ g/ml. The hybridisation buffer contained 70% deionised formamide 0.3 M NaCl and 20 mM PIPES buffer at pH 6.5. Incubation was for 1 hr at 47.5°C and the sample was then diluted and spread on H₂O as described by Wahli *et al.* (34). After spreading, the nucleic acid was visualised for electron microscopy by shadowing with platinum.

DNA binding for filter hybridisation

Plasmid DNA in TE buffer containing 0.2 M NaCl was sonicated to an average size of 1 kB, ethanol precipitated and redissolved in 25 mM potassium phosphate buffer, pH 6.2. Then, following the addition of 4

volumes of DMSO, the DNA was heated for 10 minutes at 80°C and cooled on ice. Discs of ABM paper (1 cm diameter) were activated to DBM-paper as described (12) above and then incubated overnight at 4°C in the dark with 10 or in some cases 20 µg of the denatured plasmid DNA. The filters were washed twice with H₂O and treated with NaOH (0.4 M) for 30 min at 37°C, before a further 3 washes in H₂O and storage in Tris- HCl pH 8.0 (10 mM), formamide (50%) at 4°C. Filters could be re-used at least 20 times.

Hybridisation and elution of RNA from DNA-filters

Total cytoplasmic RNA (125 µg) in a final volume of 100 µl of hybridisation buffer (20 mM PIPES, pH 6.4, 0.9 M NaCl, 0.2% SDS, 1 mM Na₂ EDTA 50% formamide) per DNA filter was hybridised for 2-3 hr at 37°C. The filters were washed in 1 x SSCE (20 mM NaCl, 8 mM Na citrate, 1mM EDTA) containing SDS (0.2%) and formamide (50%) for 5 x 15 min at 37°C and the RNA then eluted in PIPES pH 6.4 (20 mM), Na₂ EDTA (1 mM), SDS (0.5%), formamide (90%) for 30 min at 37°C. The eluted RNA was reprecipitated from ethanol and translated in the reticulocyte lysate cell-free system (see below).

Preparation and incubation of reticulocyte lysate cell-free translation system

Rabbit reticulocyte lysates were prepared and incubated as described by Berridge *et al.* (16) with the addition of wheat germ tRNA (250 µg/ml). Pretreatment with micrococcal nuclease was carried out according to the procedure of Pelham and Jackson (28).

RESULTS

Characterisation of the mRNA and synthesis of complementary DNA

Total cytoplasmic RNA extracted from the livers of chronically oestrogen-treated male Xenopus contains vitellogenin mRNA which can be visualised as a faint band at 31 S when total RNA is electrophoresed in the presence of 5 mM methyl mercuric hydroxide (Fig. 1, tracks 3 and 4). Following passage through olig(dT)-cellulose, there is an enrichment of vitellogenin mRNA to at least 50% of the poly(A)-containing RNA fraction (Fig. 1, track 2) and it is the only prominent mRNA band. This mRNA coded for a 210,000 dalton protein in a rabbit reticulocyte cell-free translation system which was immunoprecipitable by antibodies to Xenopus vitellogenin (data not shown).

Complementary DNA synthesized from total cytoplasmic poly(A)-

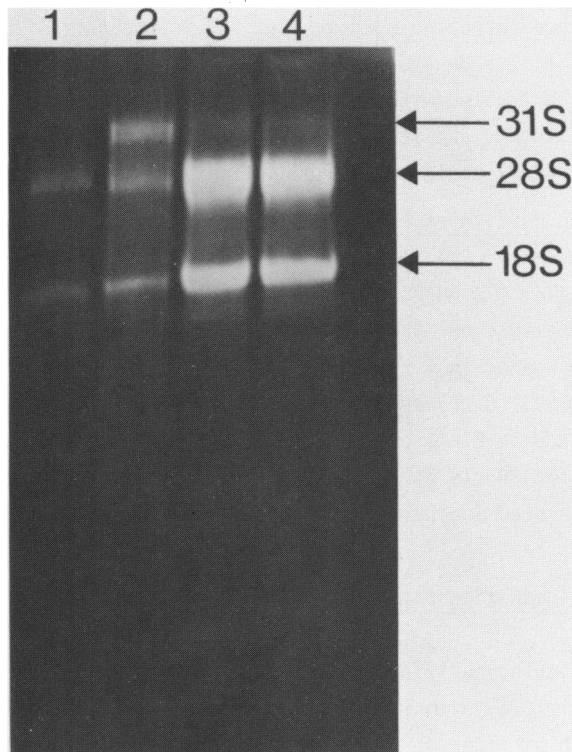

Figure 1 Analysis of oestrogen-stimulated liver RNA on agarose gels containing methylmercuric hydroxide. Track 1: Flow through from oligo(dT) cellulose chromatography of total RNA from the liver of oestrogen stimulated male *Xenopus*. Track 2: Eluate from oligo(dT) cellulose chromatography of same RNA. Track 3 and Track 4: Total RNA before chromatography.

containing RNA ranged in size from 1000-2000 nucleotides (data not shown). When the cDNA was hybridised to the RNA used for its synthesis, it hybridised with the kinetics shown in Fig. 2.

The RNA population contained an abundant species which hybridised to a component of the cDNA mixture, with a $\log Rot_{1/2}$ value of -2.6. This RNA species comprised at least 50% of the RNA population and, because of the data presented above, it was assumed that this rapidly hybridising RNA species was vitellogenin mRNA. The rapidly hybridising cDNA was purified by hydroxyapatite chromatography following hybridisation to $\log Rot$ -1.5. When this purified cDNA was hybridised with poly(A)-containing RNA, the

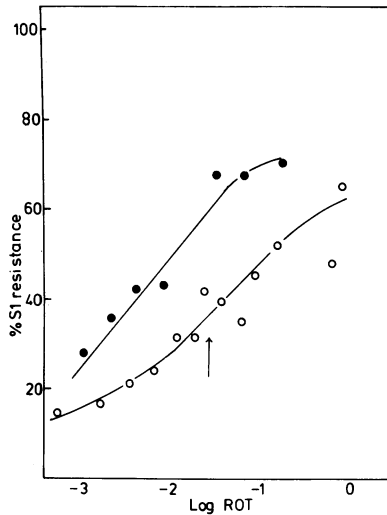

Figure 2 Hybridisation kinetics of oestrogen-stimulated mRNA with its cDNA copy. Rot curve analysis was performed as described in text. -○- hybridisation of total cytoplasmic poly(A)-containing RNA with its cDNA copy; the arrow indicates the Rot value used in the large scale purification of abundant cDNA. -●- hybridisation of the abundant cDNA with total cytoplasmic poly(A)-containing RNA.

annealing curve showed the characteristics expected for the hybridisation of a single mRNA species (Fig. 2) with a log Rot_{1/2} of -2.75. This is close to the value expected for hybridisation of vitellogenin mRNA with its cDNA. This data showed that the rapidly hybridising cDNA fraction comprised a reasonably pure cDNA which almost certainly contained vitellogenin sequences and therefore this cDNA was inserted into a bacterial plasmid as the first stage in molecular cloning.

Cloning of the cDNA copy

This procedure is illustrated in Fig. 3. The cDNA fraction was made double-stranded, using AMV reverse transcriptase. This reaction was monitored using S1 nuclease and approximately 25% of the input cDNA was rendered double-stranded by this criterion. S1 nuclease was then used to cleave the single-stranded loop at the 3' end of the cDNA molecules.

The bacterial plasmid vector used for cloning the ds cDNA was pBR 322 (29). The ampicillin gene of this plasmid contains a restriction site for *Pst* I and therefore, transformants which contain DNA sequences inserted at this site can be detected by screening for resistance to tetracycline (tet^r)

and sensitivity to ampicillin (amp^{S}). Cleavage by *Pst* I produces 3' OH termini which can act as efficient primers for the terminal transferase-catalysed addition of homopolymeric tails. It has been shown (29) that tailing of *Pst* I-digested pBR 322 with deoxyguanosine residues and tailing of the DNA fragments to be cloned with deoxycytidine residues, followed by their *in vitro* annealing and *in vivo* or *in vitro* repair, generates two *Pst* I sites on either side of the inserted sequence (see Fig. 3). Hence, it is possible to remove the cloned DNA sequence from the recombinant plasmid by digestion with *Pst* I.

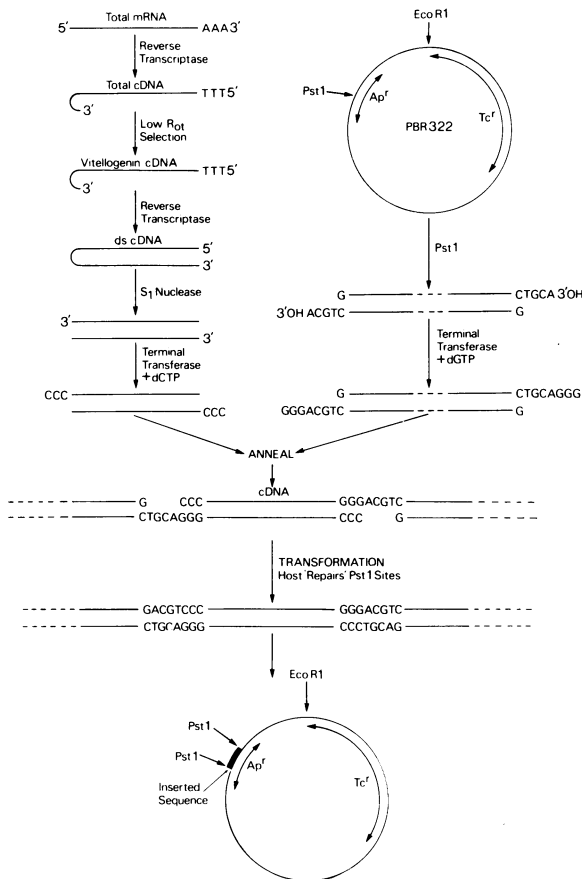

Figure 3 Procedure used for the insertion of double-stranded cDNA copy of vitellogenin into the *Pst*-I site of the plasmid pBR 322. *Ap*^R, ampicillin resistance gene; *Tc*^R, tetracycline resistance gene; *Eco* RI, *Pst* I, restriction enzyme cleavage sites; ds cDNA, double-stranded cDNA.

The 3' OH termini of the double-stranded vitellogenin cDNA were extended with deoxycytosine residues and Pst I-digested pBR 322 DNA was similarly extended with deoxyguanosine residues. Approximately equimolar amounts of the tailed moieties were then annealed and used to transform Ca^{2+} - and Mn^{2+} -treated E.coli X 1776. 523 tet^r clones were obtained by annealing 10 ng of tailed ds cDNA and 300 ng of tailed linear pBR 322 DNA. Of these, 11.5% were tet^r , amp^s and these colonies were screened by colony hybridisation to total cytoplasmic poly(A)-containing RNA labelled in vitro with ^{32}P . The strength of the hybridisation signal, over the "background" hybridisation observed with colonies containing plasmid DNA alone, varied between individual colonies. In order to determine whether the strength of the hybridisation signal reflected the length of the insert, cleared lysates of 5 colonies were prepared and analysed by electrophoresis in an 0.8% agarose flat-bed gel. The largest plasmid DNA band was from a clone termed E7 and the size of the 5 plasmid DNAs agreed well with the strength of the hybridisation signal of the clones. Hence it was possible to select clone E7 as containing the longest insert, merely on the strength of its hybridisation signal in the Grunstein-Hogness hybridisation (25). This proportionality is observed because the RNA is cleaved before ^{32}P labelling and therefore the amount of RNA hybridising to a fragment is dependent upon its length. An accurate estimate of the size of the cloned segment in E7 was obtained by restriction analysis of purified DNA. As can be seen in Fig. 4, Pst I digestion of E7 yielded 2 fragments of DNA in addition to the plasmid band. The combined size of these 2 fragments gave the size of the insert as 1700 nucleotides. The segment of vitellogenin sequence in E7 therefore contains a single Pst I site (in addition to those produced at the termini by annealing the insert with the plasmid DNA). This size estimate was confirmed using the enzyme HhaI which digests pBR322 DNA to give a band of 0.23 kB containing the Pst site. In the case of E7 DNA this fragment is replaced by a fragment of 1.9 kB; therefore the insert in E7 must be 1.67 kB in length.

Characterisation of the inserted sequence

In order to prove that E7 was indeed a cDNA clone derived from vitellogenin mRNA, two different hybridisation procedures were used.

The in situ hybridisation procedure of Alwine et al. (14) was used to show that E7 hybridised to vitellogenin mRNA. The autoradiogram in Fig. 5 shows the hybridisation of nick-translated E7 DNA with RNA covalently bound to DBM-paper. There is specific hybridisation between

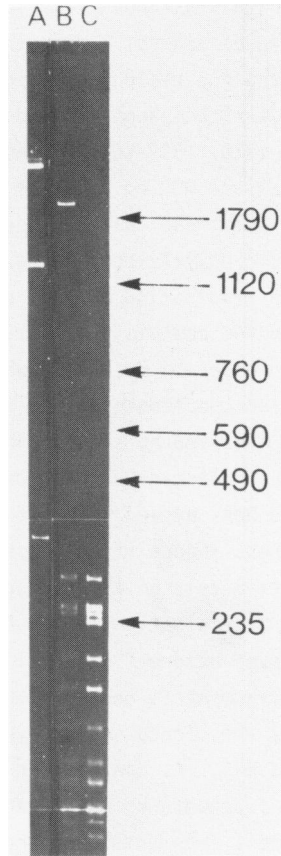

Figure 4. Acrylamide gel electrophoresis of restriction fragments derived from E7 DNA. Samples were analyzed on 3.5% acrylamide gels as described in Materials and Methods. Track A: Digest of E7 with Pst. Track B: Digest of E7 with Hha. Track C: Digest of PBR 322 with Hha. The arrows indicate the length in kB of DNA fragments in a marker track run in the same gel, this was a HinF digestion of SV40 DNA.

the plasmid DNA and an RNA which migrated to the position in the gel expected for a 6.7 kB species. This 31S species of RNA was present in female or oestrogen-treated male liver, but absent from untreated male liver. (A similar result was obtained when another clone (termed C11) was used as the hybridisation probe). While this result shows that we have cloned fragments of cDNA derived from an RNA of the correct molecular weight for vitellogenin mRNA it is obviously essential to prove that the RNA hybridising to the cloned DNA fragment is indeed vitellogenin mRNA.

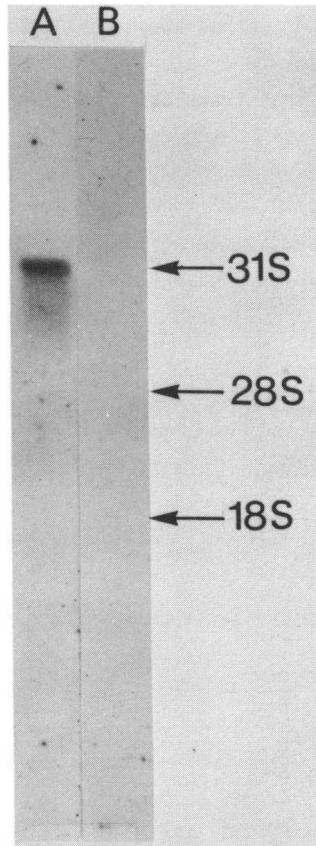

Figure 5 Hybridisation of nick-translated E7 DNA to RNA transferred from a gel to DBM paper. 30 μ g of total cytoplasmic RNA from the livers of (Track A) vitellogenic females and (Track B) unstimulated male *Xenopus* were electrophoresed on a methyl mercury gel and transferred to DBM paper. The paper was then hybridised with 0.5 μ g of E7 DNA at 5×10^7 cpm/ μ g and autoradiographed for 2 hr. The arrows indicate the position of migration of RNA markers run on the same gel and detected by staining.

Several initial attempts to confirm this, using the technique of hybrid-arrested translation (30), were unsuccessful, for reasons which will be discussed later (see Discussion). The procedure we have used to confirm the identify of the cloned plasmid DNA involved the use of a new procedure which is an extension of a technique described by Stark and Williams (31). In this technique, plasmid DNA covalently bound to DBM-paper discs is used to select complementary mRNA sequences. E7 DNA was bound to such discs and

hybridised with total cytoplasmic RNA from the livers of oestrogen-treated male Xenopus. Unbound RNA was washed away and the bound mRNA was eluted and translated in a reticulocyte lysate cell-free system (16). The analysis of the products of this translation is shown in Fig. 6. E7 DNA hybridised to an mRNA which was subsequently translated to produce a 210,000 dalton polypeptide (Track B) which co-migrated with the principal product obtained using total cytoplasmic RNA from oestrogen-treated male Xenopus livers to direct the cell-free system (Track A). This product was immuno-precipitable with antibody raised against native Xenopus vitellogenin

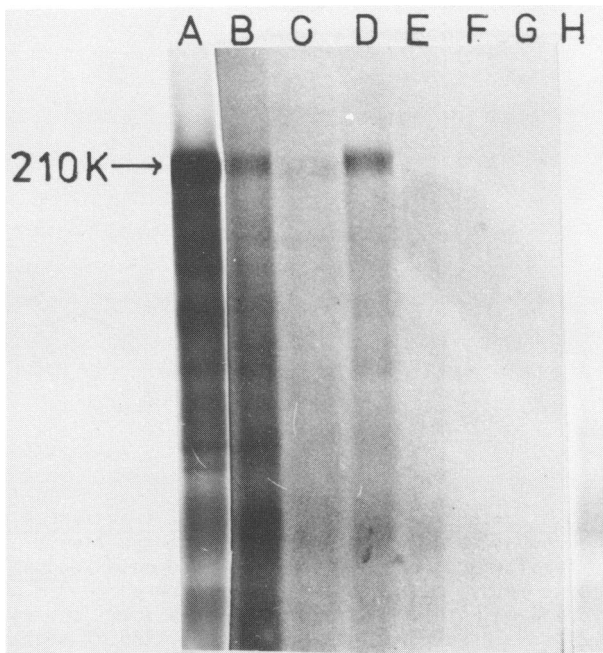

Figure 6 Translation of mRNA hybridising to plasmid DNA bound to DBM filters 20 μ g of plasmid DNA from clones E7 (Track B), E11 (Track C) and C11 (Track D) was bound to DBM filters and hybridised to total oestrogen stimulated RNA from the liver of male Xenopus as described in the text. This is an autoradiogram of the translation products of this mRNA resolved on an SDS gel. Tracks EFG show the translation product obtained when heterologous plasmid DNA is used (see text), Track A shows the translation product of the total RNA before hybridisation and Track H shows the endogenous translation product obtained in the absence of added RNA.

(result not shown). Control filters bearing plasmid DNA containing a Xenopus globin sequence (also inserted at the Pst site of pBR 322 with poly dG-poly dC tails (32)) did not select for vitellogenin mRNA (Tracks EFG). The faint pattern of bands present in these tracks are endogenous products which are synthesised in the reticulocyte lysate in the absence of exogenous mRNA (Track H). In preliminary experiments (results not shown) we demonstrated that a similar specific binding of vitellogenin mRNA by a filter bearing E7 DNA was observed when both the E7 and control filter were hybridised to RNA in the same tube (we performed this experiment with filters in both the possible relative positions in the tube and found that this did not influence the result). We have also used two other putative vitellogenin clones (both of which have shorter cDNA inserts: C11, 0.5 kB; E11, 0.84 kB) and DNA from both of these clones hybridised to an mRNA which gave a translation product co-migrating with authentic vitellogenin translation product (Fig. 6, Track E and Track D).

Position of the 1.7 kB cloned insert within the vitellogenin mRNA sequence

Having established that the DNA cloned in E7 derived from a segment of vitellogenin mRNA, we decided to determine the position of the cloned insert within the mRNA sequence. We chose to do this by electron microscopy of "R loops" (15) formed between purified vitellogenin mRNA and E7 plasmid DNA converted to a linear form by digestion with the restriction enzyme BamI. Using conditions established by Wahli et al. (33) we were able to form R-loops at a low but reasonable efficiency. Two typical examples are shown in Fig. 7. Eighteen such R loops were measured and the length of the duplex portion of the R loop was estimated to be 1.6 (\pm 0.25) kB which agrees reasonably well with the estimates of the insert length derived from gel electrophoresis (Fig. 4). The cloned insert derives from near one end of vitellogenin mRNA and our estimate of the distance between the cloned insert and the end of the mRNA is 0.65 (\pm 0.13) kB. The initial cDNA preparation used for cloning contained very few molecules longer than approximately 2.5 kB. However, Wahli et al. (34) have shown that there is an internal initiation site for cDNA synthesis at a point in the vitellogenin molecule 2.8 kB from the 3' end. Therefore the cloned insert in E7 could derive from either the 3' or the 5' end of the molecule. To distinguish these possibilities, we prepared a 3' terminal fraction from vitellogenin mRNA.

This was prepared by performing a limited base cleavage (0.1 N NaOH for 15 minutes at 4⁰C) on a preparation of total cytoplasmic RNA from the liver of an oestrogen-stimulated male animal. This RNA was

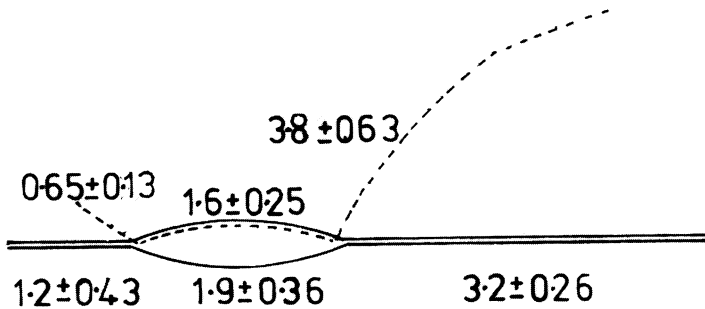
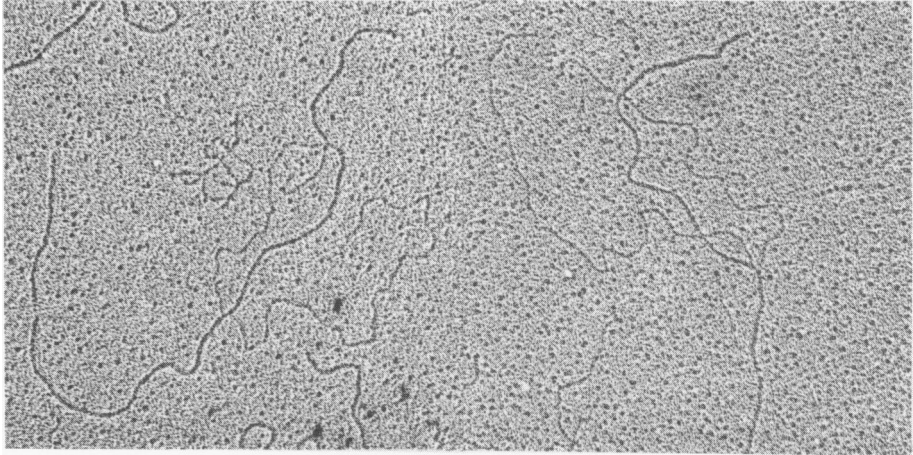

Figure 7 Electron micrograph of R loops formed between purified vitellogenin mRNA and BamHI digested E7 DNA. The long arm of the duplex DNA in the molecule at the right has been cut from the print to allow for mounting. The schematic representation shows the estimated length in kB (\pm S.D.) determined by measurement of eighteen different molecules.

sedimented on a neutral nucrose gradient and RNA of 1.5 kB and smaller was selected. This RNA was then bound to polyU sepharose and eluted with a linear gradient from zero to 90% formamide. Fractions were assayed for polyadenylate containing RNA by hybridising with an excess of ^3H polyU (20). A small amount of polyadenylated material eluted in 10% formamide, and this we assume to be the oligo(A)-containing RNA (34). The major peak eluted at between 30 and 40% formamide and this polyadenylated fraction was end-labelled *in vitro* with $\gamma\text{-}^{32}\text{P}$ ATP and polynucleotide kinase using a procedure which generates RNA fragments of about 100 nucleotides in length (25). The specific activity of the RNA was estimated to be about 10^6 cpm/ μg .

Aliquots (7,000 cpm) of this RNA were then hybridised with plasmid DNA bound to DBM filters (20 μ g per filter, as described above). Three different vitellogenin plasmids and a control plasmid containing *Xenopus* globin DNA (termed 6A5 - Kay and Williams, unpublished) were used. After hybridisation for 20 hr at 34°C in 5 x SSC, 50% formamide the filters were washed in 2 x SSC, 50% formamide at 34°C and the hybridised RNA was eluted with alkali and counted in a toluene based scintillant. All three vitellogenin plasmids

Table 1 Hybridisation of vitellogenin plasmid DNA to the 3' portion of vitellogenin mRNA.

Plasmid DNA bound to filter	cpm hybridised	Average cpm after background deduction	% of input hybridised
6A5	41 40	-	-
E7	262 276	228	3.3%
E11	330 343	294	4.2%
C11	364 369	326	4.7%

Duplicate filters were used for each point and hybridisation was as described in the text.

showed a strong hybridisation (4 to 8 times background) with the poly(A) adjacent RNA. Very similar results were obtained in another experiment using higher stringency conditions for hybridisation and washing. The fraction of input hybridised might seem quite low. However, the efficiency of hybridisation of RNA labelled in this way is low (about 30% (25)) probably because a significant fraction of the RNA is too short to hybridise efficiently. Also of course the observation by Wahli *et al.* (personal communication) that at least four different mRNA sequences are present in vitellogenin mRNA means that at maximum only 25% hybridisation might be

obtained with any one clone. Finally the fact that the RNA is fragmented during labelling down to pieces of about 100 nucleotides means that, in the case of E7 for instance, about $\frac{1}{2}$ of the input RNA (650 nucleotides out of 1600 nucleotides) is derived from a part of the mRNA sequence outside the cloned segment and will not therefore hybridise. Taking these three factors into account the observed level of hybridisation is quite reasonable. Thus all three of the cloned segments derive from the 3' end of the RNA.

NB. It was not deemed worthwhile to determine the level of hybridisation with the oligo(A)-containing RNA because in the case of E7, one would also expect hybridisation with this fraction. We selected RNA of up to 1.5 kB and part of the cloned segment in E7 lies within 1.5 kB of this internal oligo(A) segment. However, the fact that we obtained hybridisation with polyA adjacent RNA proves that our cloned segment must derive from the 3' end. Were the E7 segment derived from the oligo(A) it would have been transcribed in a 5' direction and therefore would not hybridise with polyA adjacent RNA.

DISCUSSION

The longest cloned sequence prepared (E7) was 1700 nucleotides in length, representing approximately 25% of the length of vitellogenin mRNA. The position of this sequence, 650 nucleotides from the 3' end of the molecule, was determined by a combination of hybridisation to poly(A)-adjacent RNA and by "R-loop" mapping. Since the vitellogenin polypeptide of 210,000 daltons requires 6,300 kB of coding sequence the insert must extend into the coding region of the mRNA. Our inability to arrest translation of vitellogenin mRNA using E7 DNA cannot therefore be the result of having cloned a portion of the 3' non-coding region. It has recently been demonstrated that there are at least four distinct mRNA species which together comprise "vitellogenin mRNA" (Wahli - personal communication, and Smith and Williams - unpublished). Hence our cloned fragment E7 must be complementary to only one out of the four mRNAs for vitellogenin and this explains why it was impossible to determine the coding properties of this fragment using hybrid-arrested translation. Cross-hybridisation between these other mRNAs and E7 DNA would not occur under the conditions of stringency used for the hybridisation reaction (0.4 M NaCl, 10 mM PIPES pH 6.4, 80% formamide at 48°C). Therefore translation of the other mRNAs would not be inhibited by hybridisation with E7 DNA.

This difficulty indicates one of the possible drawbacks of using a "negative" characterisation method and it prompted us to look for a "positive"

method of identification for our clones. The method we have used to select specific mRNAs, using DNA bound to DBM-filters, is likely to be widely applicable - the utility of this technique is indicated by the fact that vitellogenin mRNA is considerably larger in size than most cellular mRNAs. This technique has also more recently been used to identify the polypeptide encoded by an mRNA constituting only 2% of an mRNA population (Williams, unpublished) and the low background observed in this experiment indicates that less abundant mRNA sequences could be purified. The method is very rapid because the filters can be "batch-washed" to remove unbound mRNA. Finally the filters have a great advantage over millipore filters in that they can be re-used almost indefinitely without loss of DNA from the filters (31).

ACKNOWLEDGEMENTS

We would like to thank Jacky Smith for excellent technical assistance, and Rita Tilly for performing the electron microscopy. We also thank Dr. J.R. Tata for encouragement and use of laboratory facilities.

PFS is in receipt of an MRC research studentship.

[†]Present address: Department of Biochemistry, Imperial College of Science and Technology, London, SW7 2AZ, United Kingdom

REFERENCES

1. Tata, J.R. (1976) *Cell* **9**, 1-14
2. Tata, J.R. (1978) "Biochemical Actions of Hormones", vol. V, ed. Litwack, G. pp 397-431, Acad. Press, New York.
3. Tata, J.R. and Smith, D.F. (1979) *Rec. Prog. Hor. Res.*, in the press
4. Ansari, A.Q., Dolphin, P.J., Lazier, C.B., Munday, K.A. and Akhtar, M. (1971) *Biochem. J.* **122**, 107-112
5. Redshaw, M.R. and Follett, B.K. (1971) *Biochem. J.* **124**, 759-767
6. Wallace, R.A. (1970) *Biochim. Biophys. Acta* **215**, 176-183
7. Wagh, L.J. and Knowland, J. (1975) *Proc. Nat. Acad. Sci. USA* **72**, 3172-3175
8. Green, C.D. and Tata, J.R. (1976) *Cell* **7**, 131-139
9. Shapiro, D.J. and Baker, H.J. (1977) *J. Biol. Chem.* **252**, 5244-5250
10. Smith, D.F. (unpublished data)
11. Baker, H.J. and Shapiro, D.J. (1977) *J. Biol. Chem.* **252**, 8428-8434
12. Ryffel, G.U., Wahli, W. and Weber, R. (1977) *Cell* **11**, 213-221
13. Grunstein, M. and Hogness, D.S. (1975) *Proc. Nat. Acad. Sci. USA* **72**, 3961-3975
14. Alwine, J.C., Kemp, D.J. and Stark, G.R. (1977) *Proc. Nat. Acad. Sci. USA* **74**, 5350-5354
15. White, R.L. and Hogness, D.S. (1977) *Cell* **10**, 177-192
16. Berridge, M.V., Farmer, S.R., Green, C.D., Henshaw, E.C. and Tata, J.R. (1976) *Eur. J. Biochem.* **62**, 161-171

17. Singer, R. and Penman, S. (1973) *J. Mol. Biol.* 78, 321-328
18. Bailey, J.M. and Davidson, N. (1976) *Anal. Biochem.* 70, 75-85
19. Maniatis, T., Jeffrey, A. and Van deSande, H. (1975) *Biochemistry*, 14, 3787-3794
20. Williams, J.G. and Penman, S. (1975) *Cell* 6, 197-206
21. Schenk, T.E., Rhodes, C., Rigby, P. and Berg, P. (1975) *Proc. Nat. Acad. Sci. USA* 72, 989-993
22. Williams, R.E.O. (1975) Report of the Working Party on the Practice of Genetic Manipulation, HMSO, London.
23. Curtiss, R., Inoue, M., Pereira, D., Hsu, J.C., Alexander, L. and Rock, L. (1977) *Miami Winter Symposia*, Ed. Scott, W.A. and Wernu, R. Academic Press, Vol. 13. pp99-111
24. Enea, V., Vovis, G.F. and Zinder, N.D. (1975) *J. Mol. Biol.* 96, 495-509
25. Williams, J.G. and Lloyd, M.M. *J. Mol. Biol.* (in press)
26. Clewell, D.B. and Helinski, D.R. (1970) *Biochemistry* 9, 4428-4440
27. Rigby, P.W.J., Dieckmann, M., Rhodes, C. and Berg, P. (1977) *J. Mol. Biol.* 113, 237-251
28. Pelham, H. and Jackson, R.J. (1976) *Eur. J. Biochem.* 67, 247-256
29. Bolivar, F., Rodriguez, R.L., Greene, P.J., Betlach, M.C., Heyneker, H.L., Boyer, H.W., Crosa, J.H. and Falkow, S. (1977) *Gene* 2, 95-113
30. Patterson, B.M., Roberts, B.E. and Kuff, E.L. (1977) *Proc. Nat. Acad. Sci. USA* 74, 4370-4374
31. Stark, G.R. and Williams, J.G. (1979) *Nuc. Acid. Res.* 6, 195-203
32. Kay, R.M. and Williams, J.G., manuscript in preparation.
33. Wahli, W., Ryffel, G.U., Wyler, T., Jaggi, R.B., Weber, R. and Dawid, I.B. (1978) *Dev. Biol.*, in press
34. Wahli, W., Wyler, T., Weber, R. and Ryffel, G.U. (1978) *Eur. J. Biochem.* 86, 225-234.