

## Effects of Temperature on Emergence and Seasonality of West Nile Virus in California

David M. Hartley,\* Christopher M. Barker, Arnaud Le Menach, Tianchan Niu, Holly D. Gaff, and William K. Reisen

Fogarty International Center, National Institutes of Health, Bethesda, Maryland; Imaging Science and Information Systems Center and Departments of Microbiology and Immunology and Radiology, Georgetown University Medical Center, Washington, District of Columbia; Center for Vectorborne Diseases, University of California, Davis, California; Center for Disease Dynamics, Economics and Policy, Resources for the Future, Washington, District of Columbia; Department of Biological Sciences, Old Dominion University, Norfolk, Virginia

**Abstract.** Temperature has played a critical role in the spatiotemporal dynamics of West Nile virus transmission throughout California from its introduction in 2003 through establishment by 2009. We compared two novel mechanistic measures of transmission risk, the temperature-dependent ratio of virus extrinsic incubation period to the mosquito gonotrophic period (BT), and the fundamental reproductive ratio ( $R_0$ ) based on a mathematical model, to analyze spatiotemporal patterns of receptivity to viral amplification. Maps of BT and  $R_0$  were created at 20-km scale and compared throughout California to seroconversions in sentinel chicken flocks at half-month intervals. Overall, estimates of BT and  $R_0$  agreed with intensity of transmission measured by the frequency of sentinel chicken seroconversions. Mechanistic measures such as these are important for understanding how temperature affects the spatiotemporal dynamics of West Nile virus transmission and for delineating risk estimates useful to inform vector control agency intervention decisions and communicate outbreak potential.

### INTRODUCTION

The introduction of West Nile virus (WNV; family *Flaviviridae*, genus *Flavivirus*) into New York in 1999<sup>1</sup> initiated an epidemic that swept rapidly across North America. This virus invaded southern California during 2003, and within a year was detected in all 58 counties in the state.<sup>2,3</sup> West Nile virus circulates mainly between mosquitoes in the genus *Culex* and a diverse set of mostly passerine avian hosts and causes disease in humans, horses, and some bird species. The impact on avian populations has been severe in some cases, and in areas where WNV circulates consistently significant decreases from projected trends in abundance have been observed for several bird species, including American crows (*Corvus brachyrhynchos*), western scrub-jays (*Aphelocoma californica*), yellow-billed magpies (*Pica nuttalli*), and house finches (*Carpodacus mexicanus*).<sup>4</sup> Since its introduction, 2,973 human cases of WNV have been reported in California, including 1,254 neuroinvasive cases and 97 deaths.<sup>5</sup> This virus is now endemic to California and activity is detected each summer, although the intensity of transmission varies spatially and temporally. More than 60 independent local (county-level or smaller) agencies are charged with reducing the risk for epidemic transmission through the management of mosquito populations and public awareness campaigns to encourage residents to avoid exposure to mosquitoes during periods of peak biting activity.

Although surveillance programs have tracked the invasion and seasonal transmission of WNV in California, a synoptic understanding of spatiotemporal emergence and the factors leading to the rapid dispersal of WNV throughout California have not been described. Previous studies have suggested that temperature may be an important factor in the amplification transmission of WNV, especially in temperate areas such as the upper prairie states.<sup>6</sup> Warm temperature was associated statistically with higher human WNV infection risk in Connecticut<sup>7</sup> and predictive of increased WNV infection in vectors in northeast Illinois.<sup>8</sup> Increasing weekly maximum

temperature and weekly cumulative temperature were associated with the increasing incidence of reported human WNV cases during the following month in a recent study of WNV disease across the United States.<sup>9</sup> These and studies on other North American encephalitides suggest that temperature plays an important role in maintenance, amplification, and tangential human infection.

Biological mechanisms affected by warming temperature include the shortening of the duration of the gonotrophic period (GP) of the mosquito<sup>10</sup> and the extrinsic incubation period (EIP) of the virus,<sup>6,11</sup> both of which increase efficiency of transmission. Shortening the GP increases the rate of host-mosquito contact (i.e., mosquito biting) and the rate of mosquito population increase, whereas shortening the EIP decreases the time from infection to transmission and therefore the calendar age at which mosquitoes can transmit virus. Recently, the seasonal range of temperatures observed in two areas of California was used to estimate the times required for completion of the EIP and GP in *Cx. tarsalis* during the 2004 WNV epidemic year.<sup>6</sup> In these areas, WNV transmission increased markedly after temperatures became warm enough for mosquitoes to complete the EIP within two GPs, suggesting a pattern of increasing transmission efficiency with increasing temperature. Not only do vectors become infectious more quickly than at cooler temperatures (effect of the shortened EIP), they also transmit virus earlier in their reproductive lives (the effect of the shorter gonotrophic cycle). In this way, the rate of pathogen acquisition and transmission from vector to host can be expected to increase with temperature.

California, with its large geographic area (> 400,000 km<sup>2</sup>), contains great ecologic and climatic diversity. In the current study, we used a novel mechanistic measure of transmission risk and a mathematical model to analyze the spatiotemporal patterns of WNV activity from invasion to establishment (2003–2009). We present the most complete model for WNV transmission dynamics to date. Several earlier papers have developed or analyzed mechanistic models for WNV epidemiology,<sup>12–28</sup> but all have modeled birds as a single entity and none incorporated multiple levels of avian host competence. Also, only one earlier model<sup>22</sup> acknowledged temperature-dependence for any parameters. In our model, we extend these existing models by incorporating 1) three avian host classes

\*Address correspondence to David M. Hartley, Georgetown University Medical Center, 2115 Wisconsin Avenue NW, Suite 603, Washington, DC 20057. E-mail: Hartley@isis.georgetown.edu

(incompetent, moderately competent, and highly competent); 2) the effects of temperature on vector carrying capacity and transmission dynamics; and 3) infection caused by direct contact among birds and vertical transmission within vector populations. We parameterized our models using data from ecologic studies in California and then validated our outcome by comparisons with WNV seroconversion patterns in sentinel chickens. Our goal was to assess the role that environmental temperature played in the receptivity of California to WNV introduction and as a driver of spatiotemporal dynamics throughout the state.

## METHODS

**West Nile virus activity.** The California Vectorborne Disease Surveillance System monitors meteorologic factors, adult mosquito abundance, and virus activity measured by testing mosquitoes, sentinel chickens, wild birds (particularly dead birds for WNV), horses, and humans for evidence of infection.<sup>29</sup> Three elements of the California surveillance database<sup>30</sup> were used in our study. The first element used was temperature. Daily average temperature surfaces for California were acquired at 1-km<sup>2</sup> resolution from the National Aeronautics and Space Administration Terrestrial Observation and Prediction System.<sup>31</sup> The second element used was mosquito abundance. Host-seeking *Culex* vector species were collected systematically by local mosquito control agencies by using dry ice-baited traps.<sup>32</sup> Mosquitoes were enumerated by species and sex, and reported as females per trap type per night per collection period. Mosquito infection rates were not used in the current models or validation procedures. The third element used was sentinel chicken flocks. Flocks of 10 hens were deployed at approximately 230 locations throughout the state to measure virus transmission. Blood samples were taken biweekly to screen for antibodies by using an enzyme immunoassay.<sup>33</sup> Positive birds were confirmed, and the infecting virus was identified by immunofluorescence assay, Western blot, or plaque reduction neutralization test.<sup>34</sup> Dead or antibody-positive chickens may be replaced with seronegative birds. Husbandry and sample collection methods were approved by University of California Davis Internal Animal Care and Use Committee protocols.

Field and laboratory personnel at participating agencies entered surveillance data into the California Surveillance Gateway. Permission to use data for 2003–2009 was granted through a CalSurv Data Use agreement with partner agencies from the California Vectorborne Disease Surveillance System (CalSurv; <http://www.calsurv.org>), including the Mosquito and Vector Control Association of California, California Department of Public Health, and University of California, Davis.

All data were aggregated for each agency at a half-month time step, which was sufficient to resolve seasonal patterns and corresponded well with the frequency of mosquito trapping and sentinel chicken flock monitoring by most mosquito control agencies. Data were stored in PostgreSQL version 8.4 (<http://www.postgresql.org>) databases with added spatial capabilities of PostGIS (<http://postgis.refrains.net>) and were aggregated and analyzed by using a combination of queries in SQL and scripts in R version 2.10.<sup>35</sup>

**Mathematical modeling.** To investigate the expected impact of temperature on WNV emergence and transmission, we constructed a mathematical model (Figure 1). This model

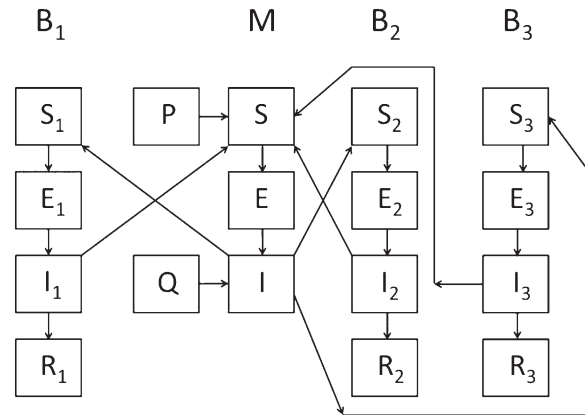

FIGURE 1. Schematic of the SEIR model constructed for West Nile virus circulation in California. Birds (B) are categorized as highly competent (1), moderately competent (2), or incompetent (3), and adult mosquitoes (M) may emerge from uninfected (P) or vertically infected (Q) eggs. See the text for a complete explanation.

made the following assumptions regarding the ecology of WNV in California.

- 1) There are three prototypical hosts. The first, host B<sub>1</sub>, was an amplification host that developed high viremia, has a relatively high probability of infecting feeding vectors, and frequently succumbed to infection (e.g., Western scrub jay [*Aphelocoma californica*]). Host B<sub>2</sub> was a maintenance host that developed a moderate viremia, which resulted in a lower probability of infecting feeding vectors, and usually survived infection (e.g., house finch [*Carpodacus mexicanus*]). Host B<sub>3</sub> was a dead-end host (e.g., mourning dove [*Zenaidura macroura*]) that developed low viremia, which resulted in no vector infection, and as such, diverted infectious mosquitoes from feeding on competent hosts. Host B<sub>3</sub> therefore represented a sink of WNV.<sup>36,37</sup> Mathematically, hosts B<sub>1</sub>–B<sub>3</sub> could represent any hosts fed upon by vectors.
- 2) At any given time, vertebrate hosts were either susceptible (S) to infection, infected but not infectious (i.e., they possess a latent infection, E), infectious with WNV (I), or immune after recovery from infection (R). If a host survived, after clearing infection, it was assumed to retain immunity for life.<sup>38,39</sup>
- 3) Vertical transmission occurred infrequently in the mosquito population.<sup>40,41</sup> Mosquito eggs were either uninfected (P) or infected (Q) and matured into either susceptible (S) or infectious (I) adults, respectively.
- 4) Avian hosts also may become infected (E) through contact with other infectious hosts. This infection could occur as a result of fecal shedding of virus at a communal roost,<sup>42</sup> predation,<sup>43</sup> or scavenging of infectious carcasses.<sup>36</sup> This type of infection was believed to occur at low rates in comparison to infection by mosquito bite during the warmer parts of the year.
- 5) At any given time, adult mosquitoes (M) were either susceptible (S) to WNV infection, infected but not infectious (E, during the extrinsic incubation period), or infectious with WNV (I). Mosquitoes were assumed to remain infectious for life<sup>6</sup> and blood feed on hosts B<sub>1</sub>–B<sub>3</sub> in proportion to their abundance in the environment.<sup>44,45</sup>

- 6) The growth of all vector and host populations was logistic and characterized by their respective rates of birth and non-disease related mortality.

The GP, EIP, and vector environmental carrying capacity ( $1/\beta_{VB}$ ,  $1/\varepsilon_1$ , and  $K_1$ , respectively, in the model equations) were modeled as being temperature-dependent. The vector transmission rate was modeled as the product of the probability of transmission from vector to host (i.e., vector competence) divided by the temperature-dependent gonotrophic period. The EIP was modeled as  $1/(-0.132 + 0.0092 \times \text{temperature})$  by using a published linear regression of median extrinsic incubation rates for *Cx. tarsalis*.<sup>6</sup> The EIP values were truncated at temperatures below the thermal minimum of 14.3°C. These values were similar for the *Cx. pipiens* complex.<sup>46</sup> The environmental carrying capacity for vectors was approximated by fitting a four-parameter logistic model relating half-monthly mean temperatures to log-transformed counts of female vector mosquitoes per trap-night (*Cx. tarsalis* and the *Cx. pipiens* complex) from CO<sub>2</sub>-baited traps operated throughout California during 2003–2009 during the same half-months.

The model was fitted (using the `nls()` function in R) and the resulting equation for the carrying capacity was computed as  $K_1 = \text{pop}_{\text{base}} \times \exp(0.05326 + 3.11241/(1 + \exp((14.56325 - \text{Temp}_t)/2.93755)))$  in which where  $\text{Temp}_t$  is the temperature for half-month  $t$  and  $\text{pop}_{\text{base}}$  is an arbitrary baseline that scaled annual fluctuations in abundance. In California, trends in abundance tend to follow antecedent temperature, but a model that captures all relevant effects of temperature would necessarily be complicated and beyond the scope of the current study. In addition, because of the Mediterranean climate of California, nearly all precipitation occurs during the winter, and therefore rainfall-driven models are not appropriate. Our attempts to accommodate mosquito production from the diversity of irrigated agroecosystems also has been complex from a state-wide perspective, especially considering the difference in larval habitats exploited by *Culex tarsalis* and the *Culex pipiens* complex. Therefore, we have used temperature to drive the seasonality of vector abundance. Finally, the gonotrophic period (i.e., the number of days between blood meals) was modeled as  $\text{GP} = 2 + 1/(-0.066 + 0.018 \times \text{temperature})$  by using a published linear regression equation for the ovarian maturation rate<sup>10</sup> plus two days for oviposition and locating a blood meal host. Similar to the EIP, the GP was truncated at temperatures below the thermal minimum (3.7°C).

We implemented the full model in terms of differential equations (mathematical details appear in the Appendix) and applied the methods described by van den Driessche and Watmough<sup>47</sup> to derive an expression for the basic reproduction ratio ( $R_0$ ). For directly transmissible infections, this ratio represents the number of secondary cases that arise from a single infectious case introduced into a completely susceptible population,<sup>48,49</sup> so that when  $R_0 < 1$ , there are insufficient new cases per case for propagation and the pathogen cannot persist in the population. When  $R_0 \geq 1$ , the pathogen is efficiently transmitted and becomes endemic; greater  $R_0$  values indicate that transmission is more intense (and therefore may spill over to infect equines and humans) and that stochastic fadeout of the pathogen is less likely. For complex models of vectorborne infections, it has been demonstrated that out-

breaks are possible for  $R_0 < 1$  under certain circumstances.<sup>50,51</sup> Because the model incorporates vertical and horizontal transmission,  $R_0$  for the current WNV system was the sum of the  $R_0$  values for each mode of transmission determined separately,  $R_0 = R_0^{(V)} + R_0^{(H)}$ .<sup>52,53</sup> Details of the  $R_0$  computation and a sensitivity analysis of the model appear in the Appendix.

$R_0$  was a function of the parameters of the model (notation and parameter descriptions are shown in Supplemental Appendix Table 1. After introduction into a fully susceptible population, if  $R_0 > 1$ , herd immunity will not, in general, be zero, as it was in the disease free state. However, for the purposes of this study,  $R_0$  still remains a measurement of the intrinsic transmissibility of the virus.<sup>54</sup> By using a temperature-dependent biting rate, EIP, and vector environmental carrying capacity, we were able to compute  $R_0$  as a function of temperature from our model. The prevalence of immunity in WNV hosts throughout California at the beginning of each transmission season is unclear. Because the annual appearance of susceptible nestlings suggests that herd immunity is decreased each year,  $R_0$  represents a measure of transmission risk until WNV circulates and herd immunity increases significantly. In this study, the use of  $R_0$  is meant to estimate the risk of transmission assuming low levels of herd immunity, not as a measure of transmission intensity as circulation increases during an outbreak.

Daily mean air temperatures for  $R_0$  calculations were obtained at 1-km<sup>2</sup> resolution from the National Aeronautics and Space Administration Terrestrial Observation and Prediction System and were adjusted to approximate mean temperatures to which mosquitoes were exposed during their daily activities.<sup>55</sup> Because *Culex* mosquitoes are nocturnally active,<sup>56</sup> they avoid peak afternoon air temperatures by resting in shelters where temperatures are lower than air temperatures; this difference was greater during summer (4.15°C) than winter (1.55°C). We fitted a sinusoidal function to monthly temperature differences from Meyer and others<sup>55</sup> and applied these reductions to the Terrestrial Observation and Prediction System air temperatures for each half-month. Estimated mosquito exposure temperatures were averaged within the boundaries of each 20-km grid cell, and the averages were used to calculate  $R_0$  values. Maps of  $R_0$  were created by using the `maptools` and `rgdal` packages in R, and serologic results from sentinel chickens were added to the maps as an indication of WNV transmission throughout the state.

Stochastic sampling from ranges of parameter estimates was applied to assess the sensitivity of  $R_0$  to the model parameters. The ranges of values used for each parameter are shown in Supplemental Appendix Table 2. The range of  $K_1$ , the vector carrying capacity, was computed from the function for  $K_1$  described above by varying the temperature over the range of minimum and maximum values of California temperatures. Likewise, the EIP and vector GP were functions of temperature. We assumed a uniform distribution for each parameter across ranges shown in Supplemental Appendix Table 2. The ranges of all the other parameters are from the references shown in Supplemental Appendix Table 1. Because our model includes  $V = 21$  uncertain variables,  $N = 300$  sets of sampled parameter values were generated by Latin hypercube sampling according to the suggestion of Matala<sup>57</sup> that an  $N$  such that  $N/V > 10$  should suffice for the number of stochastic samples of complete parameter sets. Partial rank correlation



coefficients were computed across ranges of parameters described in Supplemental Appendix Table 2 to assess the significance of each parameter with respect to  $R_0$ .

## RESULTS

Values of  $R_0$  across California for May–October 2003 and 2004 that were calculated by using the approach described in the Appendix are shown in Figure 2. These periods included the initial introduction (2003) and subsequent spread (2004) of WNV throughout California. During May 2003,  $R_0$  values were greatest in mosquito control districts in the southeastern deserts, and only these districts and those at the southern end of the Central Valley had  $R_0$  values approaching 1, implying

receptivity to WNV enzootic activity. In general,  $R_0$  was lower along the western coast compared with inland areas because of the cooling influence of the Pacific Ocean. From the second half of July through September 2003, every mosquito control district in southeastern deserts and the Central Valley had  $R_0 \geq 1$ . The first sentinel chicken flocks that seroconverted to WNV during early August were in the Imperial County along the southern border of California with Mexico, and had the highest  $R_0$  values, including values  $\geq 1$  in every half-month from late May–early October 2003.

In 2004, a similar spatio-temporal pattern and trend for temperature and  $R_0$  emerged, except that WNV activity was detected earlier in the season, most likely caused by interseasonal virus persistence. In May 2004 one flock

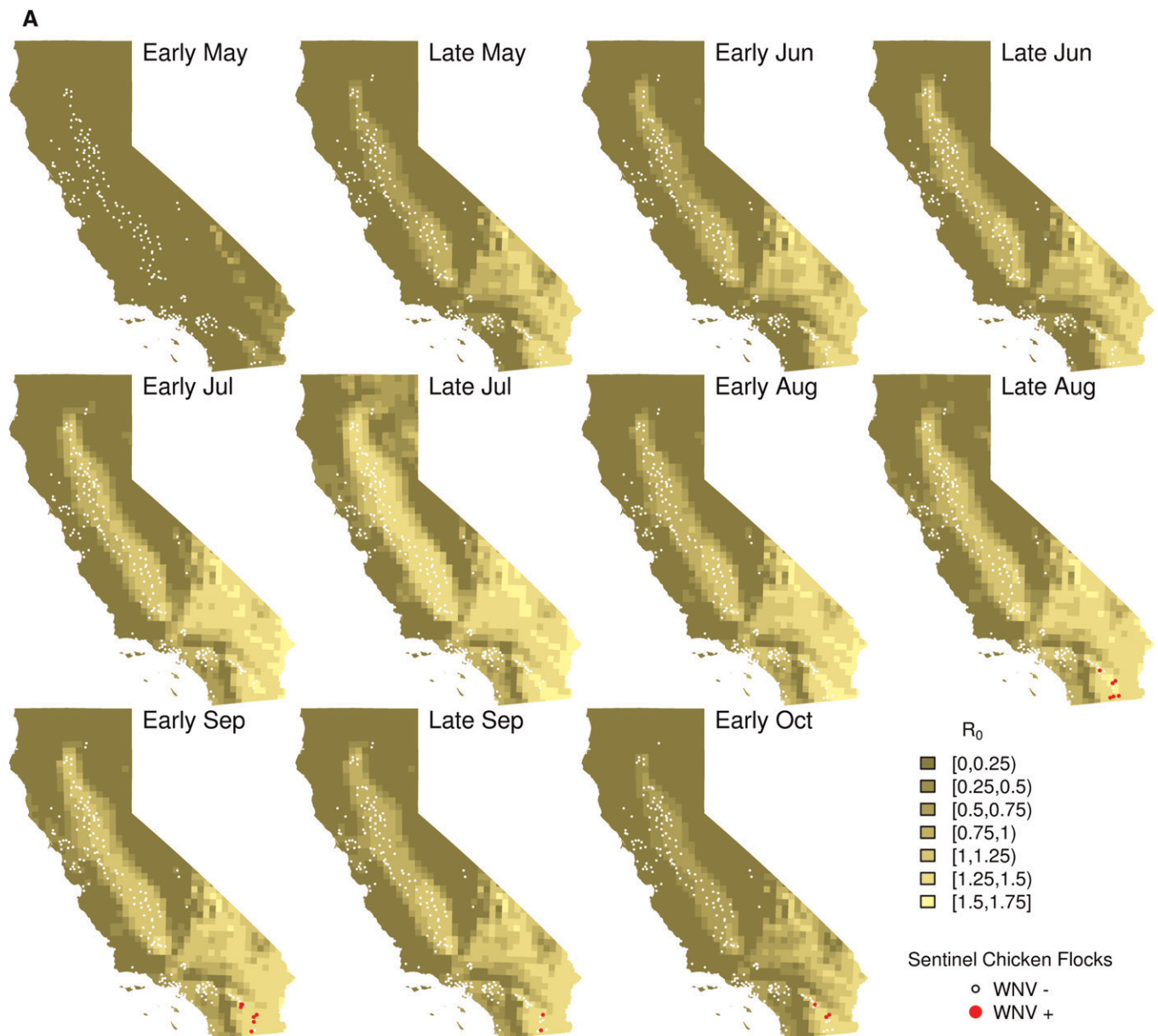
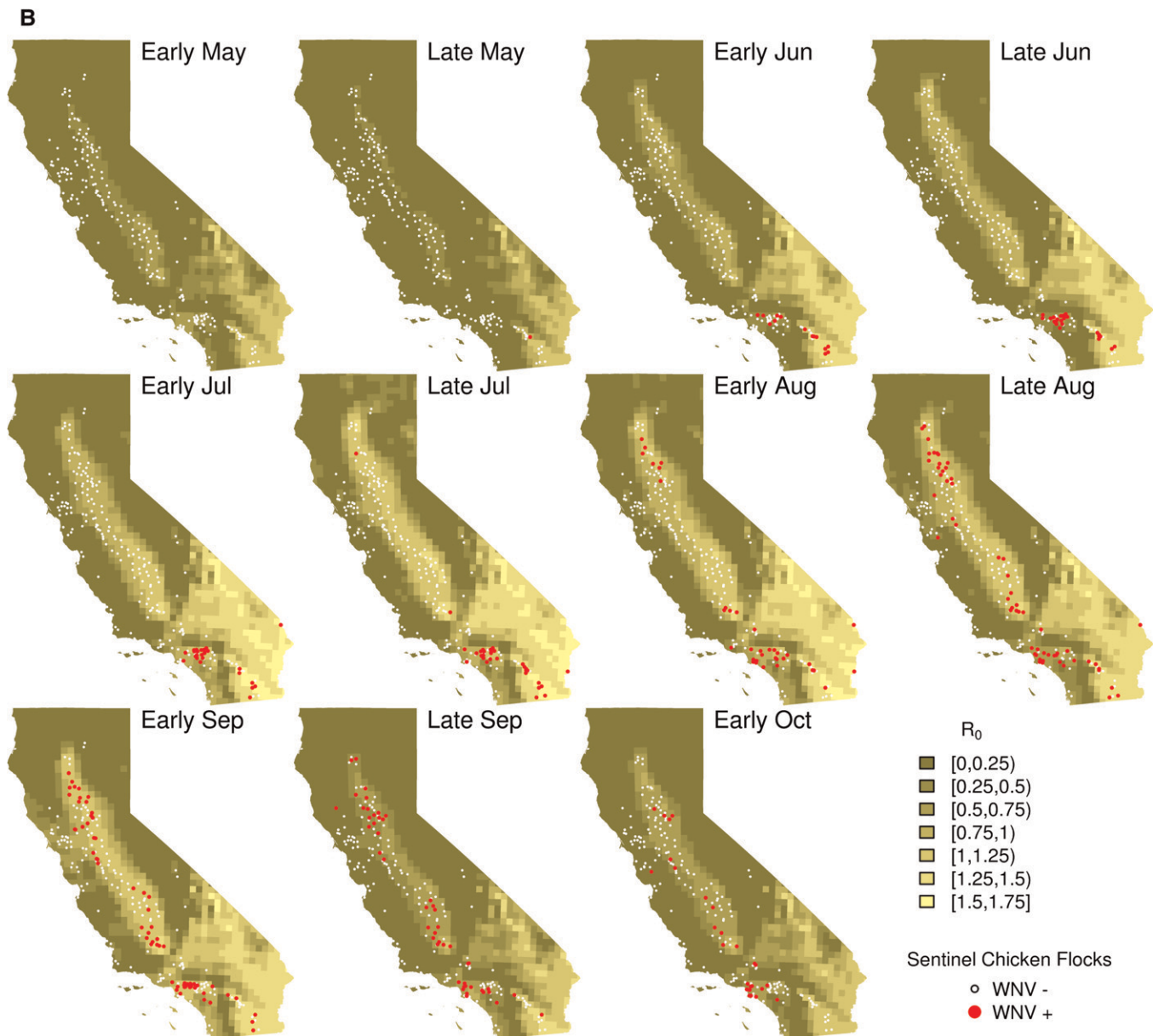

FIGURE 2. Calculated fundamental reproductive ratio ( $R_0$ ) estimates during the period of West Nile virus (WNV) introduction and spread in California, 2003 (A) and 2004 (B). Green colors indicate  $R_0$  estimates below or above the threshold value of 1, with less intense colors indicating values greater than 1 (see scale). For comparison of  $R_0$  values with observed transmission patterns, sentinel chicken flocks are indicated by circles, with red or white circles representing flocks with or without serological evidence of WNV transmission during each half-month, respectively.

FIGURE 2. *Continued.*

seroconverted in the Coachella Valley in the southeast, followed by a northwestward progression of seroconversions into the inland areas of the Los Angeles Basin, with relatively few seroconversions occurring along the coast. This pattern in Los Angeles was similar for other measures of virus activity including mosquito infection and dead bird reports and WNV-positive test results.<sup>36</sup> Notably, in the first half of July 2004, there were simultaneous seroconversions in flocks at the southern and northern ends of the Central Valley, which was warmer than areas in between that were cooled by the intrusion of marine air from the San Francisco Bay. Transmission subsequently spread but remained most prominent in southern California and the northern and southern ends of the Central Valley, with only sporadic evidence of transmission to sentinel chickens elsewhere.

The correspondence between sentinel seroconversions (i.e., WNV transmission) and  $R_0$  in the areas surrounding the

flocks was striking. In no instance were seroconversions observed in areas where  $R_0 < 1$  in 2003, and in the entire 2003–2009 data set, 5.7% of chicken samples were positive in areas with  $R_0 \geq 1$ , compared with 1.7% of samples in areas with lower  $R_0$ . The proportions of chickens with seroconversions increased with increasing  $R_0$  (Figure 3), further indicating that the  $R_0$  values derived from the model represented the intensity of transmission, although it was clear that transmission occurred below the conventional  $R_0$  threshold of 1. A time series of model-generated  $R_0$  values for three mosquito control districts, in two-week time steps during 2003–2009, is shown in Figure 4. The three districts (Coachella Valley, Sacramento-Yolo, and Marin-Sonoma) were chosen to represent hot, moderate, and cool regions of the state, respectively. Note the clear seasonality of WNV and the varying durations of these transmission seasons. Transmission seasons in hot districts tended to be longer than the seasons in cool districts,

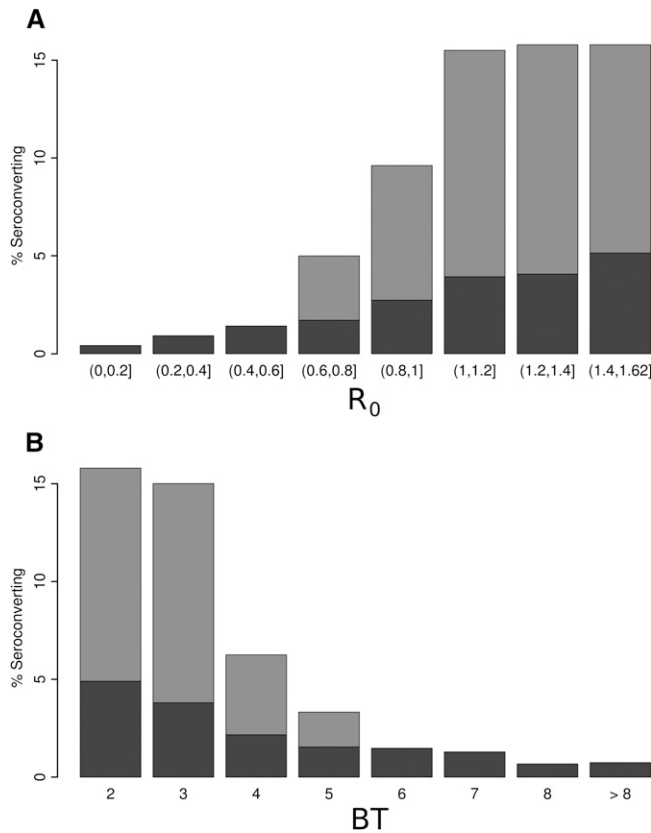

FIGURE 3. Relationship between seroconversions in sentinel chickens and calculated values for fundamental reproductive ratio ( $R_0$ ) (A) and the temperature-dependent ratio of virus extrinsic incubation period to the mosquito gonotrophic period (BT) (B) during May–October 2003–2009. Graph shows means (height of gray bars) and 90th percentiles (total height of gray plus blue bars; if the blue bar is not visible, mean was > 90th percentile) for the percentage of chickens that seroconverted to West Nile virus in each agency over the range of  $R_0$  values calculated in this study.

and peak  $R_0$  in hot districts (ranging approximately from 1.5 to 1.6 in these simulations) were substantially higher than the peak  $R_0$  in cool districts (which ranged between approximately 0.25 and 0.75). Districts with intermediate temperatures had results between these values. Also evident in the  $R_0$  time series were changes in the time of onset (when  $R_0$  first exceeded 1) and the time of peak  $R_0$  from season to season. From 2004 onward after WNV had spread throughout California, the duration of WNV transmission to sentinel chickens was closely related to the length of the transmission season defined by  $R_0$  (Figure 4).

Significant partial rank correlation coefficient values showed which model parameters had the greatest influence on  $R_0$  over the ranges used (Supplemental Appendix Table 2). As expected, temperature (T) greatly influenced model performance because several key model parameters such as mosquito carrying capacity ( $K_1$ ), virus extrinsic incubation ( $1/\epsilon_1$ ), and host contact rates [ $\beta_{B1V}$ ] were functionally linked to changes in T over space and time. The rate of vertical transmission ( $q_1$ ) also was highly significant, possibly because of its impact on rapid amplification without delays caused by extrinsic incubation. As expected,  $R_0$  also was highly sensitive to the dynamics of infection in the highly competent avian

host 1 including birth and death rates, duration of infection, and the disease-related mortality rate.

To further understand the impact of temperature on transmission, we derived a simple algebraic formula as an explicit function of the  $R_0$  model parameters. The EIP was an important factor in determining the seasonality of arbovirus transmission because transmission was impossible when the EIP exceeded the lifespan of a vector. This situation occurred during cool seasons at temperate latitudes. If the EIP was completed within the vector lifespan, transmission was possible, but the probability of transmission became more likely as the duration of the EIP decreased. The potential for acquiring and transferring virus also depended upon the length of the gonotrophic period or the time between successive blood meals. A longer GP resulted in fewer blood meals taken by a mosquito per unit time, and a shorter GP increased the biting rate per period. Both EIP and GP were temperature dependent (Figure 5A) and decreased as temperature increased. Interestingly, the ratio of the WNV EIP:GP also decreased as a function of temperature (Figure 5B). This ratio estimates the number of bites to transmission (BT) after infection of a mosquito vector as  $BT = EIP/GP$ , which is the EIP expressed in units of gonotrophic cycle length or vector blood meals. We compared the behavior of  $R_0$  with the simpler function BT (black line in Figure 4). Note the strong inverse relationship between  $R_0$  and BT. When the temperature was such that the EIP was many multiples of GP, then transmission was inefficient (low  $R_0$ ). Transmission within a single GP (i.e., the next bite after infection) was unlikely at temperatures in California unless there were significant delays in oviposition or blood meal host acquisition. Therefore, the most efficient transmission (highest  $R_0$ ) occurred when the EIP was < 2 GP. This situation is clearly evident in Figure 4 and from examination of Figure 8 in the report by Reisen and others in 2006.<sup>6</sup>

The spatio-temporal behavior of the ratio BT throughout California during 2004 was comparable to the pattern of  $R_0$  for the same period (Figure 6). Most (55.0% during 2004 and 58.8% during 2003–2009) seroconversions occurred in areas and time periods where  $BT = 2$ –3, which meant that transmission of WNV was expected by the second or third blood meal after infection. Low values of BT were closely associated with the development of foci of WNV transmission during the spring and early summer, and these areas seemed to serve as starting points for the introduction of WNV into adjacent regions, such as the cooler coastal areas of the Los Angeles Basin or the southern end of the San Francisco Bay (Figure 6). As the warm areas of California began to cool in late Sep 2004 and estimates of BT increased, transmission subsided. Overall, transmission to sentinel chickens was most intense when BT reached its minimum of 2, and the incidence of seroconversions in chickens increased as BT decreased (Figure 3B).

## DISCUSSION

Warm temperatures are known to facilitate the transmission of vectorborne pathogens, and estimates of vectorial capacity<sup>58</sup> usually assume an even distribution of vector bites in time, which results in a smooth increase in transmission efficiency with warming temperature. In reality, *Culex* vectors of WNV generally take a single blood meal per gonotrophic period because females are almost never collected host-seeking with partially developed ovaries,<sup>59–61</sup> gonotrophic periods



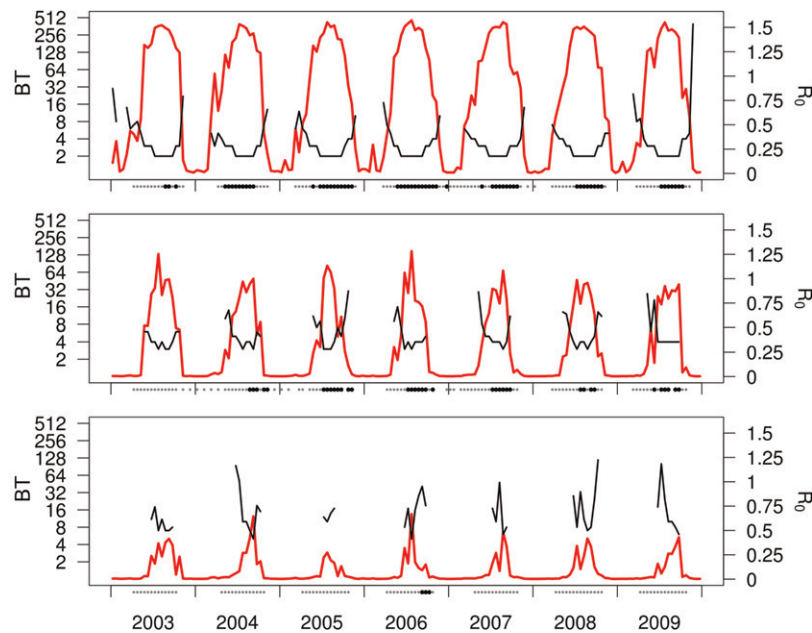

FIGURE 4.  $R_0$  as a function of time (plotted in red) for representative mosquito control districts along the cool northern coast of California (Marin-Sonoma; bottom panel), in the warm Central Valley (Sacramento-Yolo; middle panel), and in the hot southeastern deserts (Coachella Valley; top panel). BT, the ratio of extrinsic incubation period to the gonotrophic period as a function of time, is plotted in black. Values of BT are shown only for periods when West Nile virus (WNV) amplification is theoretically possible (i.e., when temperatures were above the WNV replication threshold of 14.3°C). For comparison, sentinel chicken flocks are indicated along the x-axis by circles, with black and gray circles representing flocks with or without serologic evidence of WNV transmission, respectively.  $R_0$  = fundamental reproductive ratio.

require several days for completion, and all eggs are laid at once at night. Therefore, a female that becomes capable of transmitting WNV within a gonotrophic period would not transmit virus until after oviposition, when she takes her next blood meal. This resulted in marked differences in the proportion of mosquitoes expected to survive the extrinsic incubation at different temperatures (Figure 7). Warmer temperatures were

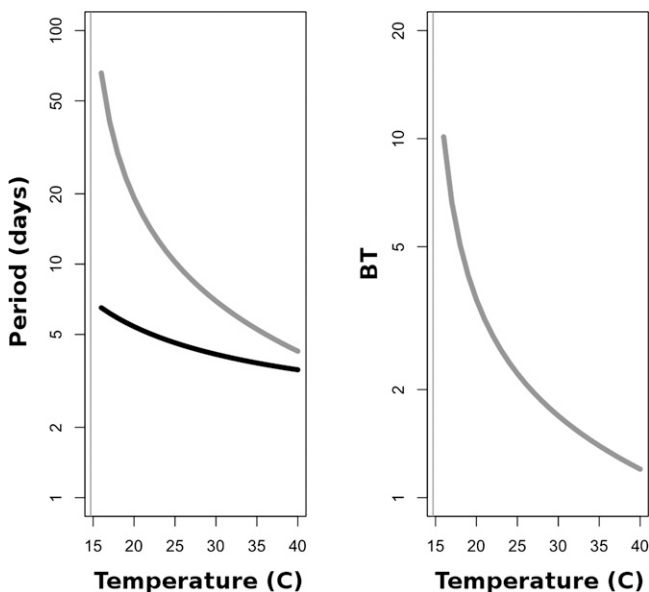

FIGURE 5. **A**, Red = extrinsic incubation period (EIP); black = gonotrophic period (GP). **B**, Ratio of EIP to GP (ratio of extrinsic incubation period to the gonotrophic period as a function of time). In both panels, the red vertical line denotes 14.3°C, the replication threshold of West Nile virus.<sup>6</sup>

associated with the greater likelihood that females survived to transmit because of shortening of the gonotrophic<sup>10</sup> and extrinsic incubation periods.<sup>6</sup> Although survival decreased as temperatures increased,<sup>62</sup> more females survived to transmit at the cooler end of each level of BT, reaching a maximum of approximately 26.7°C (Figure 7). Transmission within a single gonotrophic period was not expected to occur commonly in nature because it required incubation temperatures above 47.6° (the intersection of curves in Figure 5A), which was outside the thermal tolerance limits of WNV vectors,<sup>60</sup> some alteration of the typical midgut virus dissemination pathway occurred to enable earlier transmission,<sup>11</sup> or there were delays in oviposition site or blood meal host acquisition thereby elongating the GP modeled in the laboratory where the requisites of life were constantly available. Because our estimates were based on median values from laboratory experiments using constant temperatures, there also may be departures from our expectations, especially under naturally cycling temperature regimens, as documented for dengue virus in *Aedes aegypti*.<sup>63</sup>

The dynamic transmission model used in our study was driven largely by temperature and successfully explained much of the observed pattern of WNV introduction, spread, and subsequent transmission to sentinel chickens as a rolling epidemic tracking increases in  $R_0$ . Clearly, other factors were also important, including movements of birds and vectors, avian immunity, mosquito control operations, and habitat availability. Our sensitivity analysis suggested that the dynamics of infection in highly competent avian hosts was clearly important in amplification transmission. This finding may lead to heterogeneity of transmission focused on selected avian species serving as super spreaders responsible for a disproportionate amount of transmission. Many of the vernal transient and summer resident migrants appeared

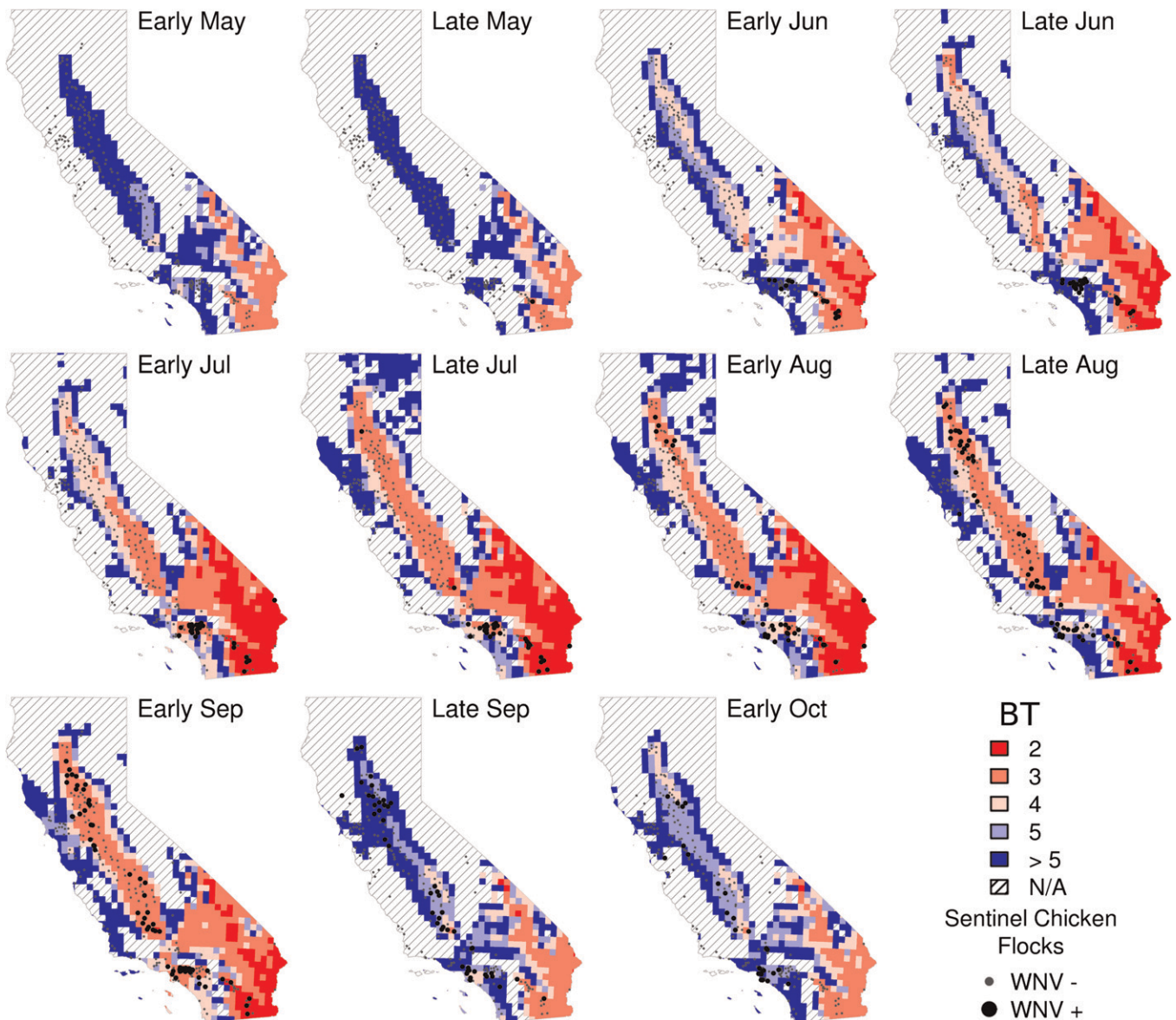

FIGURE 6. BT, the ratio of extrinsic incubation period to gonotrophic period for West Nile virus (WNV) based on estimated mean mosquito exposure temperatures during 2004 as WNV spread northward across California. Hatched areas are below the estimated threshold for WNV replication in mosquitoes.<sup>6</sup> Serologic evidence of WNV transmission to sentinel chickens is shown for comparison of extrinsic incubation periods with observed transmission patterns, with closed and open circles representing flocks with or without serologic evidence of WNV transmission during the half-month, respectively. N/A = not applicable.

to become infected during late spring as they moved into California and may have been responsible for initially moving WNV from the southeastern deserts into the Los Angeles basin and then the Central Valley.<sup>64</sup> Alternatively, the timing of the introduction and subsequent movements first into the Los Angeles Basin in 2003 and then into the Central Valley in 2004 occurred in August and June, respectively, after many of the passeriform nestlings had fledged and began to form dispersive foraging flocks. Previous models of WNV dispersal had indicated that these post-fledging movements may have been sufficient to explain the sudden jumps in WNV distribution within North America.<sup>23</sup> West Nile virus now seems to be endemic throughout California and modeled changes in  $R_0$  based on temperature and cumulative herd immunity would seem sufficient to explain the patterns of epidemic increase, subsequent subsidence, and reemergence.

Our estimates of  $R_0$  and BT agreed with sentinel chicken seroconversion rates, a measure of enzootic virus transmission. In Los Angeles,<sup>65</sup> and perhaps elsewhere in California,<sup>66,67</sup> chicken seroconversions usually lagged behind other measures of virus activity such as mosquito infection and dead bird data and may track spill over events concurrent with tangential infection of humans. These data indicated that WNV amplification may begin and proceed under  $R_0$  values  $< 1$  and precede the transmission events depicted here that may parallel spill over events and increased risk for human infection. Therefore, although WNV activity was found throughout California in 2004,<sup>3</sup> the patterns we projected paralleled increased risk for human infection with clusters of human disease detected in Los Angeles and Kern County. These delays also resulted in new seroconversions being detected late in the season after most amplification transmission subsided.



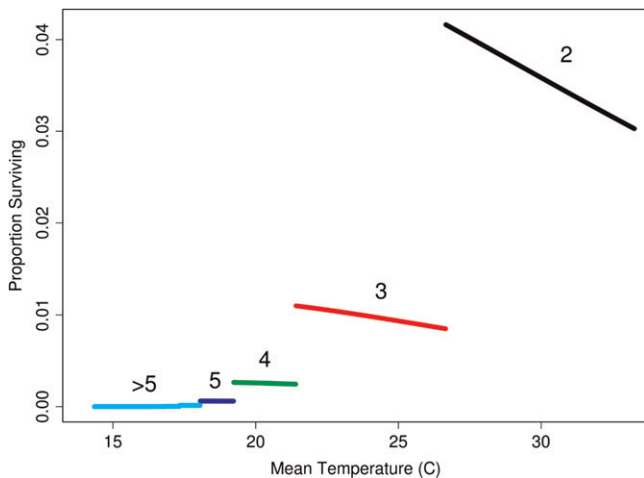

FIGURE 7. Proportion of mosquitoes surviving the minimum number of gonotrophic cycles required for West Nile virus transmission (temperature-dependent ratio of virus extrinsic incubation period to the mosquito gonotrophic period [BT]) after infection for the estimated mosquito exposure temperatures in this study. Because survival decreases with increasing temperature (daily survival =  $0.943 - 0.0092 \times \text{temperature}$ ),<sup>41</sup> for each value of BT, the greatest proportionate survival occurs at the lower end of the temperature range.

Mechanistic risk estimates such as those we presented are important for supporting the decisions of vector control agencies and for communicating risk to the public when control measures are needed. Because risk can be stated in plain language that directly relates to aspects of pathogen transmission, they provide sound guidance for policy making and should result in improved decisions. Ongoing research aims at comparisons of process-based risk estimates with established estimates of WNV transmission risk currently used in California.<sup>30</sup>

Received May 31, 2011. Accepted for publication February 4, 2012.

Note: Supplemental appendix appears at [www.ajtmh.org/content/86/5/884/suppl/DC1](http://www.ajtmh.org/content/86/5/884/suppl/DC1).

Financial support: This study was supported by the Research and Policy for Infectious Disease Dynamics program of the Science and Technology Directorate, Department of Homeland Security and the Fogarty International Center, National Institutes of Health. Christopher M. Barker and William K. Reisen are supported, in part, by Centers for Disease Control and Prevention grant U01EH000418 to study the impacts of climate change on mosquito-borne virus transmission, and National Institutes of Allergy and Infectious Diseases, National Institutes of Health grant R01 AI55607 to model amplification of WNV.

Authors' addresses: David M. Hartley and Tianchan Niu, Georgetown University Medical Center, Washington DC, E-mails: [Hartley@isis.georgetown.edu](mailto:Hartley@isis.georgetown.edu) and [Niu@isis.georgetown.edu](mailto:Niu@isis.georgetown.edu). Christopher M. Barker and William K. Reisen, Center for Vectorborne Diseases, University of California, Davis, CA, E-mails: [cmbarker@ucdavis.edu](mailto:cmbarker@ucdavis.edu) and [wkreisen@ucdavis.edu](mailto:wkreisen@ucdavis.edu). Arnaud Le Menach, Resources for the Future, Center for Disease Dynamics, Economics and Policy, Washington, DC, E-mail: [arnaudlemedenach@gmail.com](mailto:arnaudlemedenach@gmail.com). Holly D. Gaff, Department of Biological Sciences, Old Dominion University, Norfolk, VA, E-mail: [hgaff@odu.edu](mailto:hgaff@odu.edu).

## REFERENCES

- Lanciotti RS, Roehrig JT, Deubel V, Smith J, Parker M, Steele K, Crise B, Volpe KE, Crabtree MB, Scherret JH, Hall RA, Mackenzie JS, Cropp CB, Panigrahy B, Ostlund E, Schmitt B, Malkinson M, Banet C, Weissman J, Komar N, Savage

- HM, Stone W, McNamara T, Gubler DJ, 1999. Origin of the West Nile virus responsible for an outbreak of encephalitis in the northeastern United States. *Science* 286: 2333–2337.
- Reisen W, Lothrop H, Chiles R, Madon M, Cossen C, Woods L, Husted S, Kramer V, Edman J, 2004. West Nile virus in California. *Emerg Infect Dis* 10: 1369–1378.
- Hom A, Marcus L, Kramer VL, Cahoon BE, Glaser C, Cossen C, Baylis E, Jean C, Tu EH, Eldridge BF, Carney R, Padgett K, Sun B, Reisen WK, Woods L, Husted S, 2005. Surveillance for mosquito-borne encephalitis virus activity and human disease, including West Nile virus in California, 2004. *Proc Mosq Vector Control Assoc Calif* 73: 66–77.
- Wheeler SS, Barker CM, Fang Y, Armijos MV, Carroll BD, Husted S, Johnson WO, Reisen WK, 2009. Differential impacts of West Nile virus on California birds. *Condor* 111: 1–20.
- California Department of Public Health, 2010. *California West Nile Virus*. Available at: <http://westnile.ca.gov>. Accessed March 24, 2011.
- Reisen WK, Fang Y, Martinez VM, 2006. Effects of temperature on the transmission of West Nile virus by *Culex tarsalis* (Diptera: Culicidae). *J Med Entomol* 43: 309–317.
- Liu A, Lee V, Galusha D, Slade MD, Diuk-Wasser M, Andreadis T, Scotch M, Rabinowitz PM, 2009. Risk factors for human infection with West Nile virus in Connecticut: a multi-year analysis. *Int J Hlth Geograph* 8: 67.
- Ruiz MO, Chaves LF, Hamer GL, Sun T, Brown WM, Walker ED, Haramis L, Goldberg TL, Kitron UD, 2010. Local impact of temperature and precipitation on West Nile virus infection in *Culex* species mosquitoes in northeast Illinois, USA. *Parasites and Vectors* 19: 19.
- Soverow JE, Wellenius GA, Fisman DN, Mittleman MA, 2009. Infectious disease in a warming world: how weather influenced West Nile virus in the United States (2001–2005). *Environ Health Perspect* 117: 1049–1052.
- Reisen WK, Milby MM, Presser SB, Hardy JL, 1992. Ecology of mosquitoes and St. Louis encephalitis virus in the Los Angeles Basin of California, 1987–1990. *J Med Entomol* 29: 582–598.
- Kilpatrick AM, Meola MA, Moudy RM, Kramer LD, 2008. Temperature, viral genetics, and the transmission of West Nile virus by *Culex pipiens* mosquitoes. *PLoS Pathogens* 27: e1000092.
- Bowman C, Gumel AB, van den Driessche P, Wu J, Zhu H, 2005. A mathematical model for assessing control strategies against West Nile virus. *Bull Math Biol* 67: 1107–1133.
- Blayneh KW, Gumel AB, Lenhart S, Clayton T, 2010. Backward bifurcation and optimal control in transmission dynamics of West Nile virus. *Bull Math Biol* 72: 1006–1028.
- Liu RS, Shuai JP, Wu JH, Zhu HP, 2006. Modeling spatial spread of West Nile virus and impact of directional dispersal of birds. *Math Biosci Eng* 3: 145–160.
- Cruz-Pacheco G, Esteva L, Montano-Hirose JA, Vargas C, 2005. Modeling the dynamics of West Nile virus. *Bull Math Biol* 67: 1157–1172.
- Hartemink NA, Davis SA, Reiter P, Hubalek Z, Heesterbeek JAP, 2007. Importance of bird-to-bird transmission for the establishment of West Nile virus. *Vector Borne Zoonotic Dis* 7: 575–584.
- Jiang JF, Qiu ZP, 2009. The complete classification for dynamics in a nine-dimensional West Nile virus model. *SIAM J Appl Math* 69: 1205–1227.
- Jiang JF, Qiu ZP, Wu JH, Zhu HP, 2009. Threshold conditions for West Nile virus outbreaks. *Bull Math Biol* 71: 627–647.
- Kenkre VM, Parmenter RR, Peixoto LD, Sadasiv L, 2005. A theoretical framework for the analysis of the West Nile virus epidemic. *Math Comput Model* 42: 313–324.
- Lewis M, Renclawowicz J, Van den Driessche P, 2006. Traveling waves and spread rates for a West Nile virus model. *Bull Math Biol* 68: 3–23.
- Lewis MA, Renclawowicz J, van den Driessche P, Wonham M, 2006. A comparison of continuous and discrete-time West Nile virus models. *Bull Math Biol* 68: 491–509.
- Lord CC, Day JF, 2001. Simulation studies of St. Louis encephalitis and West Nile viruses: the impact of bird mortality. *Vector Borne Zoonotic Dis* 1: 317–329.
- Rappole JH, Compton BW, Leimgruber P, Robertson J, King DI, Renner SC, 2006. Modeling movement of West Nile virus in the western hemisphere. *Vector Borne Zoonotic Dis* 6: 128–139.

24. Thomas DM, Urena B, 2001. A model describing the evolution of West Nile-like encephalitis in New York City. *Math Comput Model* 34: 771–781.
25. Wan H, Zhu HP, 2010. The backward bifurcation in compartmental models for West Nile virus. *Math Biosci* 227: 20–28.
26. Wonham MJ, Camino-Beck T, Lewis MA, 2004. An epidemiological model for West Nile virus: invasion analysis and control applications. *Proc R Soc Lond B Biol Sci* 271: 501–507.
27. Wonham MJ, Lewis MA, 2008. A comparative analysis of models for West Nile virus. Brauer F, van den Driessche P, Wu J, eds. *Mathematical Epidemiology*. Berlin: Springer-Verlag, 365–390.
28. Wonham MJ, Lewis MA, Renclawowicz J, Van den Driessche P, 2006. Transmission assumptions generate conflicting predictions in host-vector disease models: a case study in West Nile virus. *Ecol Lett* 9: 706–725.
29. California Department of Public Health, 2011. *Mosquito and Vector Control Association of California, University of California. California Mosquito-Borne Virus Surveillance and Response Plan*. Available at: [http://westnile.ca.gov/downloads.php?download\\_id=820&filename=2008\\_CA\\_Mosq\\_Surv.pdf](http://westnile.ca.gov/downloads.php?download_id=820&filename=2008_CA_Mosq_Surv.pdf). Accessed March 3, 2012.
30. Barker CM, Kramer VL, Reisen WK, 2010. *Decision Support System for Mosquito and Arbovirus Control in California. Earthzine: an IEEE Publication*. Available at: <http://www.earthzine.org/2010/09/24/decision-support-system-for-mosquito-and-arbovirus-control-in-california/>. Accessed January 14, 2012.
31. Nemani R, Votava P, Michaelis A, White M, Melton F, Milesi C, Pierce L, Golden K, Hashimoto H, Ichii K, Johnson L, Jolly M, Myneni R, Tague C, Coughlan J, Running S, 2007. Remote sensing methodologies for ecosystem management. Aswathanarayana U, ed. *Food and Water Security*. Oxford, UK: Taylor & Francis, 1–19.
32. Newhouse VF, Chamberlain RW, Johnston JG Jr, Sudia WD, 1966. Use of dry ice to increase mosquito catches of the CDC miniature light trap. *Mosq News* 26: 30–35.
33. Reisen WK, Presser SB, Lin J, Enge B, Hardy JL, Emmons RW, 1994. Viremia and serological responses in adult chickens infected with western equine encephalomyelitis and St. Louis encephalitis viruses. *J Am Mosq Control Assoc* 10: 549–555.
34. Patiris PJ, Oceguela LF 3rd, Peck GW, Chiles RE, Reisen WK, Hanson CV, 2008. Serologic diagnosis of West Nile and St. Louis encephalitis virus infections in domestic chickens. *Am J Trop Med Hyg* 78: 434–441.
35. Development Core Team R, 2009. *R: A Language and Environment for Statistical Computing*. Vienna, Austria: Foundation for Statistical Computing.
36. Komar N, Langevin S, Hinten S, Nemeth N, Edwards E, Hettler D, Davis B, Bowen R, Bunning M, 2003. Experimental infection of North American birds with the New York 1999 strain of West Nile virus. *Emerg Infect Dis* 9: 311–322.
37. Reisen WK, Fang Y, Martinez VM, 2005. Avian host and mosquito (Diptera: Culicidae) vector competence determine the efficiency of West Nile and St. Louis encephalitis virus transmission. *J Med Entomol* 42: 367–375.
38. Nemeth NM, Oesterle PT, Bowen RA, 2009. Humoral immunity to West Nile virus is long-lasting and protective in the house sparrow (*Passer domesticus*). *Am J Trop Med Hyg* 80: 864–869.
39. Reisen WK, Chiles RE, Green EN, Fang Y, Mahmood F, 2003. Previous infection protects finches from re-infection with St. Louis encephalitis virus. *J Med Entomol* 40: 300–305.
40. Goddard LB, Roth AE, Reisen WK, Scott TW, 2003. Vertical transmission of West Nile virus by three California *Culex* (Diptera: Culicidae) species. *J Med Entomol* 40: 743–746.
41. Reisen WK, Fang Y, Lothrop HD, Martinez VM, Wilson J, O'Connor P, Carney R, Cahoon-Young B, Shafii M, Brault AC, 2006. Overwintering of West Nile virus in southern California. *J Med Entomol* 43: 344–355.
42. Dawson JR, Stone WB, Ebel GD, Young DS, Galinski DS, Pensabene JP, Franke MA, Eidson M, Kramer LD, 2007. Crow deaths caused by West Nile virus during winter. *Emerg Infect Dis* 13: 1912–1914.
43. Garmendia AE, Van Kruiningen HJ, French RA, Anderson JF, Andreadis TG, Kumar A, West AB, 2000. Recovery and identification of West Nile virus from a hawk in winter. *J Clin Microbiol* 38: 3110–3111.
44. Thiemann TC, 2011. Bloodfeeding patterns of *Culex tarsalis* and the *Culex pipiens* complex in California. *Entomology*. Davis, CA: University of California, 110.
45. Chaves LF, Harrington LC, Keogh CL, Nguyen AM, Kitron UD, 2010. Blood feeding patterns of mosquitoes: random or structured? *Front Zool* 7: 3.
46. Goddard L, Roth A, Reisen WK, Scott TW, 2003. Extrinsic incubation period of West Nile virus in four California *Culex* (Diptera: Culicidae) species. *Proc Mosq Vector Control Assoc Calif* 71: 70–75.
47. van den Driessche P, Watmough J, 2002. Reproduction numbers and sub-threshold endemic equilibria for compartmental models of disease transmission. *Math Biosci* 180: 29–48.
48. Anderson RM, May RM, 1991. *Infectious Diseases of Humans: Dynamics and Control*. Oxford, UK: Oxford University Press.
49. Heffernan JM, Smith RJ, Wahl LM, 2005. Perspectives on the basic reproductive ratio. *J R Soc Interface* 2: 281–293.
50. Massad E, Coutinho FAB, Burattini MN, Amaku M, 2010. Estimation of  $R_0$  from the initial phase of an outbreak of a vector-borne infection. *Trop Med International Health* 15: 120–126.
51. Dushoff J, Huang WZ, Castillo-Chavez C, 1998. Backwards bifurcations and catastrophe in simple models of fatal diseases. *J Math Biol* 36: 227–248.
52. Lipsitch M, Nowak MA, Ebert D, May RM, 1995. The population dynamics of vertically and horizontally transmitted parasites. *Proc Biol Sci* 260: 321–327.
53. Gaff H, Hartley D, Leahy N, 2007. An epidemiological model of Rift Valley fever. *Electron J Diff Eqn* 2007: 1–12.
54. Fraser C, Riley S, Anderson RM, Ferguson NM, 2004. Factors that make an infectious disease outbreak controllable. *Proc Natl Acad Sci USA* 101: 6146–6151.
55. Meyer RP, Hardy JL, Reisen WK, 1990. Diel changes in adult mosquito microhabitat temperatures and their relationship to the extrinsic incubation of arboviruses in mosquitoes in Kern County, California, USA. *J Med Entomol* 27: 607–614.
56. Reisen WK, Lothrop HD, Meyer RP, 1997. Time of host-seeking by *Culex tarsalis* (Diptera: Culicidae) in California. *J Med Entomol* 34: 430–437.
57. Matala A, 2008. *Sample Size Requirement for Monte Carlo Simulations Using Latin Hypercube Sampling*. Helsinki University of Technology, Department of Engineering Physics and Mathematics, Systems Analysis Laboratory. Available at: [www.sal.tkk.fi/publications/pdf-files/emmat08.pdf](http://www.sal.tkk.fi/publications/pdf-files/emmat08.pdf). Accessed January 14, 2012.
58. Garrett-Jones C, Shidrawi GR, 1969. Malaria vectorial capacity of a population of *Anopheles gambiae*: an exercise in epidemiological entomology. *Bull World Health Organ* 40: 531–545.
59. Mitchell CJ, Millian KY Jr, 1981. Continued host seeking by partially engorged *Culex tarsalis* (Diptera: Culicidae) collected in nature. *J Med Entomol* 18: 249–250.
60. Reisen WK, 1995. Effect of temperature on *Culex tarsalis* (Diptera: Culicidae) from the Coachella and San Joaquin Valleys of California. *J Med Entomol* 32: 636–645.
61. Wekesa JW, Yuval B, Washino RK, 1997. Multiple blood feeding by *Anopheles freeborni* and *Culex tarsalis* (Diptera: Culicidae): spatial and temporal variation. *J Med Entomol* 34: 219–225.
62. Reeves WC, Hardy JL, Reisen WK, Milby MM, 1994. Potential effect of global warming on mosquito-borne arboviruses. *J Med Entomol* 31: 323–332.
63. Lambrechts L, Paaijmans KP, Fansiri T, Carrington LB, Kramer LD, Thomas MB, Scott TW, 2011. Impact of daily temperature fluctuations on dengue virus transmission by *Aedes aegypti*. *Proc Natl Acad Sci USA* 108: 7460–7465.
64. Reisen WK, Wheeler SS, Garcia S, Fang Y, 2010. Migratory birds and the dispersal of arboviruses in California. *Am J Trop Med Hyg* 83: 808–815.
65. Kwan JL, Klugh S, Madon MB, Nguyen DV, Barker CM, Reisen WK, 2010. Sentinel chicken seroconversions track tangential transmission of West Nile virus to humans in the greater Los Angeles area of California. *Am J Trop Med Hyg* 83: 1137–1145.
66. Reisen WK, Lothrop HD, Wheeler SS, Kensington M, Gutierrez A, Fang Y, Garcia S, Lothrop B, 2008. Persistent West Nile virus transmission and the apparent displacement St. Louis encephalitis virus in southeastern California, 2003–2006. *J Med Entomol* 45: 494–508.

67. Reisen WK, Carroll BD, Takahashi R, Fang Y, Garcia S, Martinez VM, Quiring R, 2009. Repeated West Nile virus epidemic transmission in Kern County, California, 2004–2007. *J Med Entomol* 46: 139–157.
68. Reisen WK, Milby MM, Reeves WC, Meyer RP, Bock ME, 1983. Population ecology of *Culex tarsalis* (Diptera: Culicidae) in a foothill environment of Kern County, California: temporal changes in female relative abundance, reproductive status, and survivorship. *Ann Entomol Soc Am* 76: 800–808.
69. Reisen WK, Lothrop HD, Hardy JL, 1995. Bionomics of *Culex tarsalis* (Diptera: Culicidae) in relation to arbovirus transmission in southeastern California. *J Med Entomol* 32: 316–327.
70. Cornell Laboratory of Ornithology, 2011. *The Birds of North America*. Available at: <http://bna.birds.cornell.edu/bna/>. Accessed May 9, 2011.
71. Dohm DJ, O'Guinn M, Turell MJ, 2002. Effect of environmental temperature on the ability of *Culex pipiens* (Diptera: Culicidae) to transmit West Nile virus. *J Med Entomol* 39: 221–225.
72. Kilpatrick AM, LaDeau SL, Marra PP, 2007. Ecology of West Nile virus transmission and its impact on birds in the Western Hemisphere. *Auk* 124: 1121–1136.