Characterization and use of the *Drosophila* metallothionein promoter in cultured *Drosophila melanogaster* cells

Thomas A. Bunch, Yevgenya Grinblat and Lawrence S.B. Goldstein*

Department of Cellular and Developmental Biology, Harvard University, Cambridge, MA 02138, USA

Received September 14, 1987; Revised and Accepted December 29, 1987

ABSTRACT

The promoter from the metallothionein gene may be a useful conditional promoter for the construction of chimeric genes to be expressed in *Drosophila* cells in culture. To explore this possibility the responses of the endogenous metallothionein gene and an *in vitro* constructed chimeric gene containing the metallothionein promoter were examined. Copper and cadmium, when added to the growth medium of *Drosophila* Schneider's line 2 cells, can produce a 30-100 fold induction of metallothionein mRNA levels. The level of induction depends on the amount of copper or cadmium added to the medium and these mRNA levels remain high for at least four days. Copper is less toxic than cadmium and does not induce a typical heat-shock response in the cells. Finally, a chimeric gene containing the metallothionein promoter shows a similar induction when transformed into the cells.

INTRODUCTION

Conditional promoters have been used to great advantage by molecular biologists studying biological problems in both eukaryotes and prokaryotes. Genes that produce potentially lethal products can be placed under the control of such promoters and transformed into cells under conditions that result in little or no expression of the gene product. Once transformed cells are selected, the conditional promoter can be induced, leading to increased production of the gene product. Large amounts of the gene product may then be extracted from the cells and used for biochemical studies. Alternatively, observation of the phenotype of cells producing a toxic gene product may lend an understanding of the reason for its toxicity and thus elucidation of its normal function(s). In vertebrates, one of the most useful promoters for these purposes is the metallothionein promoter.

Metallothionein is a high cysteine metal binding protein that has been found in yeast, blue-green algae, arthropods, avians, insects,

and mammals [1-4]. These organisms all respond to elevated amounts of the heavy metal ions copper, zinc, and cadmium by increasing the levels of metallothionein mRNA and protein in the cell [1,5-13]. In mammals, there is good evidence that this rise in metallothionein mRNA is the result of increased transcription rates [14,15]. Regions of DNA located 5' to the metallothionein genes have been shown to be sufficient to induce transcription in the presence of heavy metals and have been termed metal response elements. The functional significance of these metal response elements has been demonstrated by placing these elements 5' to non-responsive genes and conferring metal inducibility on them [16-19].

Recently a metallothionein gene from *Drosophila melanogaster* has been isolated and its DNA sequence determined. The DNA sequence upstream of the structural gene shows homology with metal response elements described in human and mouse metallothionein genes [20]. This portion of the *Drosophila* metallothionein gene (from nucleotide -370 to nucleotide +54, with nucleotide +1 being the start of transcription) has been shown to confer responsiveness to the metallothionein gene in *Drosophila* larvae and to a chimeric gene transformed into baby hamster kidney cells [21].

In this report we examine the characteristics of induction and expression of the metallothionein gene, and a chimeric gene that contains its promoter, in cultured cells of *Drosophila melanogaster*. In addition, we report on the gross physiology and growth characteristics of cells subjected to various inducing conditions. The cell line that we have used is capable of being transformed and transformants can be selected and cloned. This should therefore be a valuable system for *Drosophila* biologists to use in concert with their analysis of biological problems at the organismic level.

MATERIALS AND METHODS

Drosophila Cell Culture and Transformation

S2/M3 cells are Schneider's line 2 cells [22] adapted for growth in M3 medium [23]. S2/M3 cells were grown in M3 medium supplemented with 12.5% fetal calf serum (FCS), which has been heat inactivated at 60°C

for 30 minutes. Transformed cells were grown in M3 medium + 12.5% FCS + 2×10^{-7} M methotrexate (methotrexate stock solution is 4×10^{-4} M in 50 mM sodium carbonate). For transformations, 3×10^6 S2/M3 cells in 3 ml of M3 medium + 12.5% FCS were seeded in 60mm tissue culture plates. DNA-calcium phosphate co-precipitates were prepared as described by Wigler et al. [24]. One ml of this precipitate, containing 20 ug of DNA, was incubated with each plate of cells for 15-18 hours. The DNA was a 1:10 (population 1 of figure 7), or 1:100 (population 2 of figure 7) ratio of the plasmids pMMAP-1:pHGCO (pMMAP-1 is described below; pHGCO is a plasmid containing the methotrexate-resistant bacterial DHFR gene [25]). After 15-18 hours, cells were collected by centrifugation at setting 6 in an IEC (International Equipment Co.) clinical centrifuge [approximate RCF (relative centrifugal force) -1100] for 20 seconds, washed once with 5 ml of M3 medium, resuspended in 5 ml of M3 + 12.5% FCS, and then plated in a 25 cm² tissue culture flask. After 4 days of growth in this non-selective medium the cells were collected by centrifugation and resuspended in the same medium containing 2×10^{-7} M methotrexate. Cells were pelleted and resuspended in fresh medium containing methotrexate every 5 days. After 40 days, the populations of transformed selected cells are comprised of actively dividing cells at about 1×10^6 cells/ml. Negative controls, cells transformed with just pMMAP-1, showed no actively dividing cells after this selection. This procedure is essentially the same as that given by Bourouis and Jarry [25] with the modifications of Robert Moss [26]. Cells are maintained between 1×10^6 and 1×10^7 cells/ml. The medium was changed or diluted, at least 1:5 with fresh medium, every 5-7 days.

Treatment of Cells with Copper or Cadmium

For the treatments of cells with copper or cadmium, 100 ul of a 100x concentrated solution of copper sulfate or cadmium chloride were added to cells growing in 10 ml of medium.

Nucleic Acid Preparation and Northern Analysis

Total nucleic acids were extracted from cell pellets by resuspending them in extraction buffer (2% SDS, 0.2 M NaCl, 10 mM Tris-HCl pH 7.5, 10 mM EDTA, protease-K at 25 ug/ml -- predigested for 30 minutes at 37°C) followed by a 30 minute incubation at 50°C. This was followed by 2 or 3 phenol/chloroform extractions, 1 chloroform extraction, and an ethanol precipitation. This protocol is a simplified version of that given by Kwan et al. [27]. PolyA+ RNA was selected with oligo-dT cellulose as

described by Maniatis et al. [28]. RNAs were electrophoresed on formaldehyde gels [28] and blotted onto GeneScreen nylon filters as suggested by the manufacturers. Instead of baking the filters, we have used the U.V. crosslinking technique of Church and Gilbert [29] to crosslink the RNA to the filter. Filters were prehybridized at 42°C for 4-16 hours in 50% formamide, 5x SSC, 50 mM sodium phosphate, 250 ug/ml sheared denatured calf-thymus DNA, 0.5% SDS, 1x Denhardt's [30]. Hybridization was carried out at 42°C for 16 hours in the same solution with the addition of dextran sulfate (10% w/v). Probes were prepared by nick translation of plasmid DNA [31]. After hybridization, the filters were washed in 2x SSC, 0.5% SDS (four 15 minute washes at 23-37°C), and 0.1x SSC, 0.5% SDS (two 15 minute washes at 50°C) [32].

Dot Blot Analysis

Dot blot analysis was done as described by Thomas [33] with slight modifications. Preliminary experiments, using total nucleic acids from cells that had been treated with copper for 24 hours, showed that loadings between 1 and 40 ug of total nucleic acids per spot give a linear increase in signal when probed with a nick translated plasmid containing the metallothionein gene. To determine metallothionein mRNA specific cpm for each of the points in figures 4 or 5, 5 ug of RNA-enriched total nucleic acids (total nucleic acids were first precipitated in 2.5 M lithium chloride on ice for 2 hours, redissolved in 0.3 M sodium acetate, and ethanol precipitated by adding 2.5 volumes of 100% ethanol-- this should remove a significant amount of the DNA present [34]), in 10X SSC (1.5 M sodium chloride and 0.15 M trisodium citrate), were spotted onto each of 6 spots on nitrocellulose. Nucleic acids were bound to the nitrocellulose by baking in a vacuum oven at 80°C for 1-2 hours. Two of the six dots were probed with nick translated plasmid, pDml31 [20], containing the metallothionein gene. Two were probed with nick translated pUC 18 [35]- essentially the plasmid that the metallothionein gene was cloned into to give the plasmid pDml31. The final two dots were probed with nick translated plasmid containing the RP49 gene [36]. Probing and washing of the filters were done with the same conditions used for Northern analysis. These spots were then placed in scintillation

fluid and counted in a Beckman scintillation counter. To obtain metallothionein specific cpm, the background counts (that given by pUC18 probing) were subtracted from the counts obtained from pDM131 probing. RP49 probing provides a control to adjust these values to correct for any loading differences. Each of the points in figures 4 and 5 represents the average of 2 such experiments done in parallel. HSP70 mRNA levels were similarly determined for figure 2.

Plasmid Constructions

For the construction of pRmHa-1 (figure 6), pUC18 was digested with Hind3 and blunt ends were created by filling in the Hind3 ends with DNA polymerase 1 large fragment [28]. This linearized blunt-ended vector was ligated with a, polyadenylation signal containing, 738 bp Hinf1 fragment, from the *Drosophila melanogaster* ADH gene (the ADH allele used came from the plasmid pSAC1 [37]), which had been similarly rendered blunt. The 5' Hinf1 site occurs naturally in the ADH gene at position 1770 [38]. The 3' Hinf1 site is derived from pUC18, into which the ADH gene had been cloned, and is 4 bases 3' to the Xba1 site at position 2500 of the ADH gene. The EcoR1-Stu1 fragment containing the metallothionein promoter [20] was then cloned into this polyadenylation signal containing plasmid, pHA-1, which had been digested with EcoR1 and Sma1. This results in the plasmid pRmHa-1 described in figure 6. pMMAP-1 was constructed by cloning a 2.1 Kb BamH1 fragment from the 205Kd microtubule associated protein (205K MAP) cDNA [41 and unpublished data] into the BamH1 site of pRmHa-1. All restriction endonucleases and other nucleic acid modifying enzymes were used as recommended by their suppliers. Ligation reactions were done as described by Maniatis et al. [28].

Suppliers

Fetal calf serum was purchased from HyClone. Restriction endonucleases, DNA polymerase 1 large fragment, and DNA polymerase 1 were from New England Biolabs and T4 DNA ligase and oligo(dT)-cellulose (type 3) were from Collaborative Research, Inc. Calf intestine phosphatase was from Boehringer Mannheim (#713-023).

RESULTS

Response of S2/M3 Cells to Inducers of the Metallothionein Promoter

Effects of metals on growth

In order to conduct physiological experiments in which gene products are conditionally expressed under the control of the metallothionein promoter in *Drosophila melanogaster* cultured cells, it is important to determine if the inducers, copper and cadmium, have detrimental effects on the cells. To test for detrimental effects, the growth of *Drosophila* S2/M3 cells was assessed in the presence of various concentrations of copper and cadmium.

In figure 1, growth rates for *Drosophila* S2/M3 cells grown in the presence of the indicated concentrations of copper or cadmium are shown. The data indicate that cells grown in 0.5 mM copper sulfate have normal doubling rates, while those grown in 10 μ M cadmium chloride or 1.5 mM copper sulfate continue to double but at slower rates. Higher concentrations of either metal are toxic to the cells. Subsequent experiments have demonstrated that growth of cells in the presence of 0.7 mM copper sulfate is identical to growth in 0.5 mM copper sulfate (unpublished data).

Induction of a heat-shock response

It has been reported that addition of heavy metals to growth media induces a heat-shock response in mammalian and avian cells [39,40]. To determine if this is the case in S2/M3 cells, HSP70 [70 Kd heat-shock polypeptide] mRNA levels from untreated cells and cells treated for 24 hours with various concentrations of copper and cadmium were examined.

Figure 2 shows that 24 hour treatment of cells with cadmium induces the accumulation of elevated levels of HSP70 mRNA. This is observed at all concentrations above 1 μ M that were tested. When time course experiments are analyzed, HSP70 mRNA levels continue to rise to higher amounts in cells treated for 48 or 96 hours with cadmium (unpublished data). In contrast, copper, even at a concentration of 5 mM, does not induce the accumulation of significant amounts of HSP70 mRNA after 24 hours. The slight induction of HSP70 mRNA levels in cells treated with 0.2 mM copper is probably due to stressing the cells during their

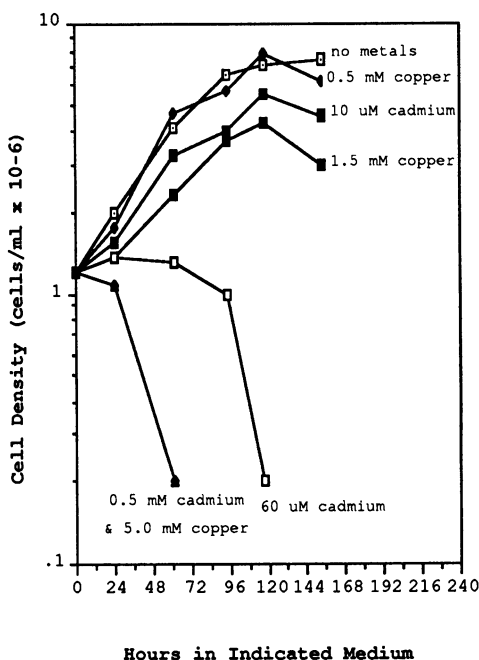

Figure 1. Growth curves of cells grown in the presence of various concentrations of copper or cadmium, or in the absence of metals. At time 0 copper or cadmium was added to 10 ml plates containing S2/M3 cells, at a density of 1.2×10^6 cells/ml, to bring the final metal concentrations to those indicated in the figure. At the various time points cell density was determined with a hemocytometer. Each of the points represents the average of two identical experiments done in parallel. Cells treated with 0.5 mM cadmium or 5 mM copper for 60 hours and those treated with 60 μ M cadmium for 120 hours were dead and were not counted at subsequent time points.

collection as this increase was not consistently seen. Analysis of time courses of expression indicate that there is a slight induction of HSP70 mRNA in copper treated cells after 6 hours of treatment. However, at the 12, 24, 48, and 96 hour time points no HSP70 mRNA above control levels is detectable (unpublished data). These same results have been observed by hybridization of an HSP70 probe to Northern blots of RNA from untreated and copper or cadmium induced cells (unpublished data).

Induction ratio of metallothionein mRNA

Before constructing chimeric genes based on the metallothionein promoter it is important to know whether the

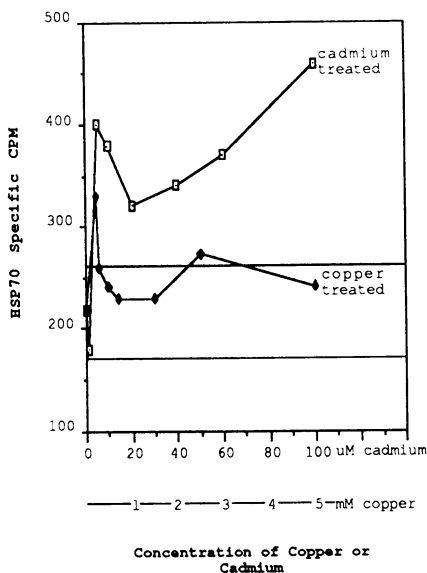
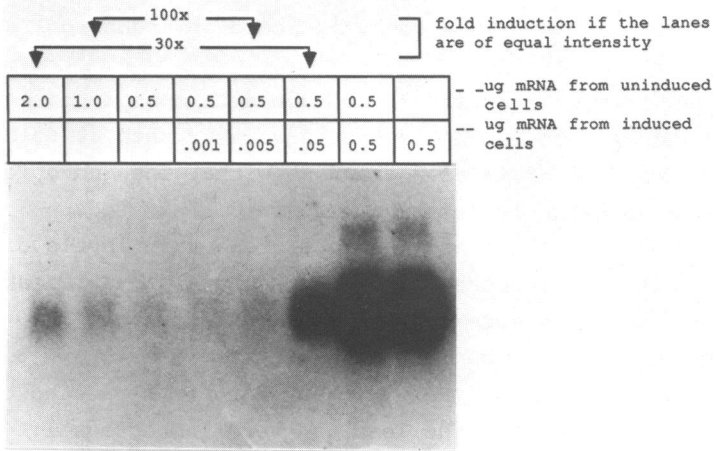

Figure 2. Dot blot analysis of HSP70 mRNA levels in S2/M3 cells treated with various concentrations of copper and cadmium. S2/M3 cells were treated with the indicated concentrations of copper and cadmium for 24 hours. Dot blot analysis was performed as described in Materials and Methods and HSP70 specific cpm, which reflects the level of HSP70 MRNA in the cells, was plotted for each of the seven indicated concentrations of copper or cadmium and for untreated cells. The two horizontal lines represent the two values obtained from untreated cells. All points are the average of two experiments done in parallel.

endogenous metallothionein gene is being significantly induced in cultured cells by the addition of copper or cadmium to the medium. As the cells grow with normal doubling rates and without inducing a heat-shock response in medium that contains up to 0.7 mM copper sulfate the induction ratio of metallothionein mRNA levels was examined after treating cells for 24 hours with this concentration of copper.

Comparison of mRNA from cells treated with or without, 0.7 mM copper indicates a dramatic induction of metallothionein mRNA (figure 3a, lanes 3 and 8). To quantitate the extent of induction, the following mixing experiment was carried out. 0.5 ug of uninduced polyA+ RNA was mixed with 0.001, 0.005 or 0.05 ug of induced polyA+ RNA (figure 3a, lanes 4, 5 and 6). By comparing

a. Metallothionein Probe



b. RP49 Probe

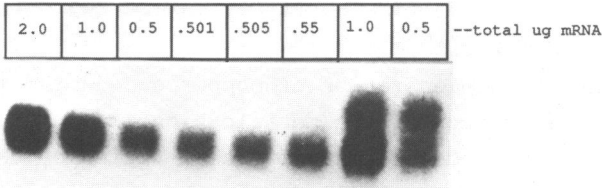

Figure 3. Northern analysis of metallothionein mRNA induction after treatment of cells with copper. PolyA⁺ RNA was isolated from untreated S2/M3 cells or cells treated with 0.7 mM copper sulfate for 24 hours. The indicated amounts of uninduced mRNA were loaded in lanes 1-7 and induced mRNA in lanes 4-8. Northern analysis was performed as described in Materials and Methods, probing for (a) metallothionein mRNA or (b) reprobng for RP49 mRNA. (a) shows that the induction has been greater than 30x (lane 6 is more intense than lane 1) and close to or slightly less than 100x (lane 5 is of similar intensity as lane 2) -- see text for explanation. (b) shows that the loadings of uninduced and induced mRNA are equal (compare lanes 3 and 8). As indicated in the text, the extra bands in lanes 7 and 8 of (b) are due to incomplete removal of the metallothionein probe before reprobng.

the signal intensities of these mixtures with lanes containing 2.0, 1.0 or 0.5 ug of uninduced polyA⁺ RNA (figure 3a, lanes 1, 2 and 3) the induction ratio is determined. If the intensity of the metallothionein signal in lane 6 which contains 0.05 ug of induced RNA plus 0.5 ug of uninduced RNA is equal to the signal intensity of lane 1 containing 2.0 ug of uninduced RNA then the amount of

metallothionein mRNA in 0.05 ug of induced polyA+ RNA must be equivalent to the amount of metallothionein mRNA in 1.5 ug of uninduced polyA+ RNA. This would indicate an induction ratio of 30.

As can be seen, the signal in lane 6 is more intense than that in lane 1, thus the induction is greater than 30 fold. Similar comparison of lanes 2 and 5 show that the induction ratio is close to or slightly less than 100 fold.

To demonstrate that all loadings are equal, levels of a non-inducible RNA were assessed. Figure 3b shows a hybridization of the filter used in figure 3a with a segment from the RP49 [ribosomal protein 49] gene. Comparison of lanes 3 and 8, which contain 0.5 ug of polyA+ mRNA from untreated and treated cells respectively, shows that the loadings were indeed equal. The extra bands in lanes 7 and 8 are due to metallothionein probe that was not completely removed from the filter before reprobing.

Dose Response and Kinetic Experiments

To determine the concentration of copper or cadmium that gives the maximal induction of the metallothionein gene, as well as to determine if the induction level can be varied by using different amounts of metal as the inducer, the relationship between the metal concentration in the medium and the response of the metallothionein gene was investigated.

The data shown in figure 4 indicate that the amount of accumulated metallothionein mRNA present after a 24 hour treatment is dependent on the amount of copper sulfate or cadmium chloride added to the growth media. Accumulated metallothionein mRNA levels increase with increasing amounts of copper in the media and reach a plateau between 0.7 and 1.0 mM copper sulfate. Cadmium chloride treatment results in a peak of induction around 10-20 uM cadmium chloride followed by a decline in metallothionein mRNA levels at higher concentrations. These same induction profiles are seen in hybridization to Northern blots of total nucleic acids (unpublished data).

In these dot blot experiments it would appear that the induction ratio in cells treated with 0.7 mM copper sulfate is only 4-5 fold as compared to the 30-100 fold induction seen in the

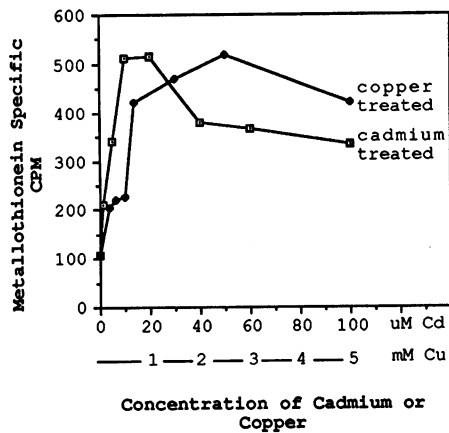

Figure 4. Dot blot analysis of metallothionein mRNA levels in cells treated with different concentrations of copper or cadmium. S2/M3 cells were treated for 24 hours with the indicated concentrations of copper or cadmium and dot blot analysis was performed as described in Materials and Methods. Metallothionein mRNA levels are reflected in metallothionein specific cpm. All points are the average of two experiments.

mixing experiment shown in figure 3. One possibility is that this is due to the saturation of the RNA binding capacity of the filters used for these experiments. However loading 4 times the amount of mRNA results in a 4 fold increase in metallothionein signal (unpublished data). Therefore, it is unlikely that the low induction seen here is due to saturation effects. Mixing experiments, performed exactly as in figure 3, with the same two uninduced samples and the same two 0.7 mM copper sulfate treated samples used in figure 4 (all points are the average of two experiments) again show a 30-100 fold induction (unpublished data). We therefore conclude that the untreated point in our dot blot experiments may be an overestimate of the basal levels of metallothionein mRNA levels in untreated cells.

In order to use the metallothionein promoter for physiological experiments it is important to determine whether the addition of copper or cadmium to the growth media results in a transient, or a prolonged increase in metallothionein mRNA levels. To determine which of these alternatives is correct the levels of metallothionein mRNA were examined at various times after the addition of metal to the growth medium.

Figure 5 shows data from cells grown in the presence of various levels of copper or cadmium. In cells treated with non-toxic concentrations of copper (0.1-0.5 mM) or cadmium (10 uM) the levels of metallothionein mRNA increase to a peak between 24 and 48 hours and then remain high for at least 4 days. With 1.5 mM copper sulfate, which slows the growth of cells (figure 1), the metallothionein mRNA levels rise to a peak and then decrease. The same is true for 40 and 150 uM cadmium chloride. Thus, the addition of non-toxic levels of copper or cadmium results in a prolonged increase in metallothionein mRNA levels.

A transcription vector based on the metallothionein promoter

As shown above, expression of the endogenous metallothionein gene is responsive to the presence of copper or cadmium in the growth medium. Thus, it can be concluded that S2/M3 cells have the necessary trans-acting factors required for activation of the metallothionein promoter. To capitalize on this observation and to determine if this is indeed a useful conditional expression system in *Drosophila* cultured cells, chimeric genes that contain the metallothionein promoter and the proposed metal response element were constructed. To facilitate the construction of such chimeric genes a transcription vector was developed. A restriction map of this vector, pRmHa-1, is shown in figure 6. It is based on the bacterial plasmid pUC18 [35] and contains the metallothionein promoter and metal response consensus sequences. The segment of the metallothionein gene used extends from the EcoR1 restriction site at nucleotide -370 to the StuI restriction site at nucleotide +54 (with nucleotide +1 being the start of transcription). Nucleotide +54 is located in the 5' untranslated leader sequence [20]. Following this promoter are four unique restriction enzyme (cloning) sites and then the 3' portion of the *Drosophila* ADH gene. This ADH segment extends from 35 bp upstream of the polyadenylation/cleavage sequence, in the 3' untranslated portion of ADH mRNA, to 700 bp downstream of the polyadenylation signal. Thus, DNA cloned into this vector should be transcriptionally regulated by the metallothionein promoter and polyadenylated. As shown below, in the analysis of a chimeric gene, these expectations are indeed correct.

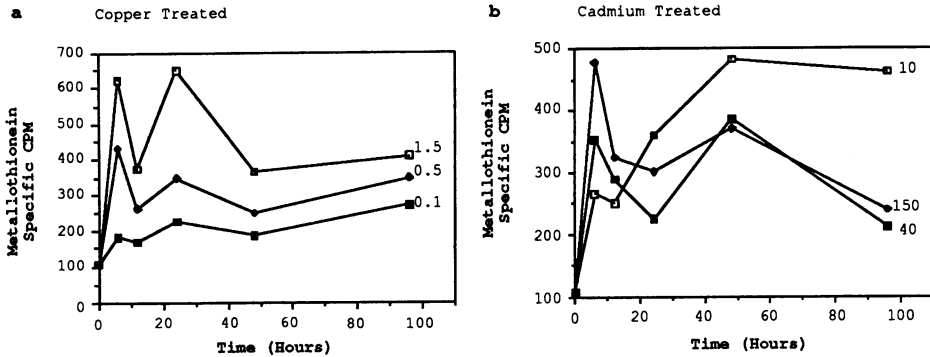

Figure 5. Dot blot analysis of cells treated for various times with different concentrations of copper or cadmium. S2/M3 cells were treated for 0, 6, 12, 24, 48 or 96 hours with (a) 0.1, 0.5 or 1.5 mM copper sulfate or with (b) 10, 40 or 150 uM cadmium chloride. Dot blot analysis of RNA from these cells was performed as described in Materials and Methods to determine metallothionein mRNA levels (as reflected in metallothionein specific cpm). All points are the average of two experiments.

Similar expression vectors that contain the additional unique cloning sites EcoR1, SacI, KpnI and SmaI after the metallothionein promoter have been constructed (not shown, but available upon request).

Analysis of a Chimeric Gene

To test the responsiveness of the transcription vector pRMHa-1 a 2.1 Kb portion of the *Drosophila* 205 Kd microtubule associated protein (205K MAP) cDNA [41] was inserted into the vector. This results in the plasmid pMMAP-1. S2/M3 cells were co-transformed with this plasmid and the plasmid pHGCO [25]. The plasmid pHGCO contains the bacterial DHFR [dihydrofolate reductase] gene, which confers resistance to methotrexate. Thus, transformed populations of cells can be selected by growth in methotrexate containing media [25]. PolyA⁺ mRNA from these transformed populations was collected from either untreated cells or cells grown in the presence of 0.7 mM copper sulfate for 24 hours. Figure 7 shows Northern blots of polyA⁺ RNA hybridized with probes for either (a) 205K MAP homologous RNA or (b) RP49 mRNA. Lanes 1 and 2 of figure 7a show that there is no change in the levels of endogenous 205K MAP mRNA after the addition of 0.7

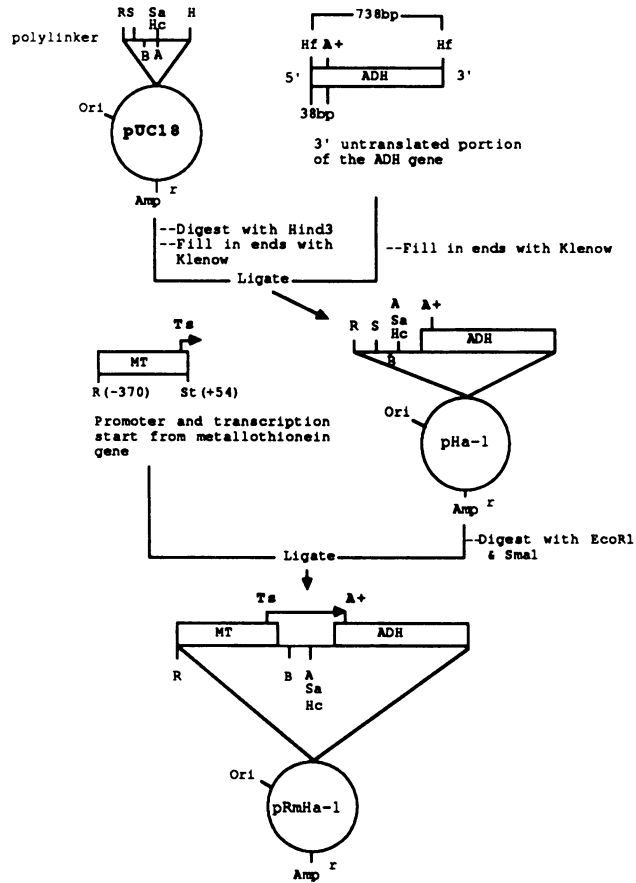

Figure 6. Construction of the plasmid pRmHa-1. The expression vector pRmHa-1 is based on the bacterial plasmid pUC18 and contains the promoter, metal response element and transcriptional start site (Ts) from the metallothionein (MT) gene followed by the unique cloning sites BamHI (B), AccI (A), Sall (Sa) and Hinc2 (Hc), and the polyadenylation signal (A+) from the *Drosophila melanogaster* alcohol dehydrogenase (ADH) gene. It also contains the origin of replication (Ori) and the beta-lactamase gene conferring resistance to ampicillin (Amp^r) from pUC18. Other restriction endonuclease sites shown in the construction are Hind3 (H), HinfI (Hf), SmaI (S), EcoRI (R) and StuI (St). A detailed description of this construction can be found in the Materials and Methods.

mM copper sulfate to untransformed cells. However, transformed cells show a dramatic increase in the amount of 205K MAP homologous RNA (transformed gene product) following exposure to

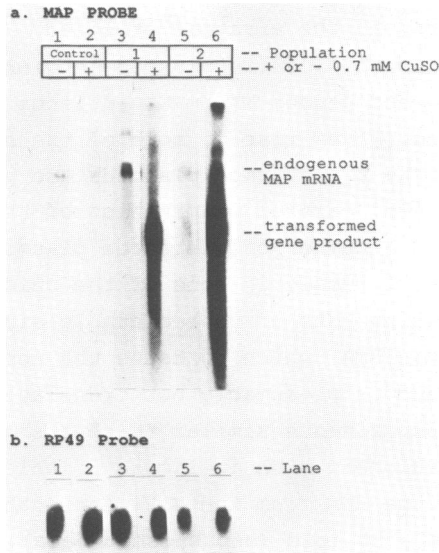

Figure 7. Northern analysis of RNA from cells transformed with a chimeric gene containing the metallothionein promoter. PolyA⁺ RNA was isolated from three populations of cells that were untreated (lanes 1,3 and 5) or treated with 0.7 mM copper sulfate for 24 hours (lanes 2,4 and 6). These populations were either untransformed S2/M3 cells (Control--lanes 1 and 2) or S2/M3 cells transformed with a 1:10 (population 1--lanes 3 and 4) or a 1:100 (population 2--lanes 5 and 6) ratio of pMMAP-1:pHGCO. This RNA is analyzed by Northern analysis probing for (a) MAP homologous RNA, which hybridizes to the transformed chimeric gene RNA. (b) is a probing of identically loaded lanes for RP49 mRNA to show that for each pair of lanes the amount of polyA⁺ mRNA is equivalent.

copper. This is shown by comparing lanes 3 and 4, and lanes 5 and 6 of (a). Each pair of lanes represents a different transformed population of cells. As can also be seen in these figures, there is a smear of RNA above and below the appropriately sized chimeric gene product. We suggest that this improperly sized RNA results from incorrectly terminated RNA, possibly resulting from the ADH gene's cleavage/polyadenylation signal functioning at less than 100% efficiency. The principal evidence for this hypothesis is that we commonly see inducible RNAs that are the expected length plus one or two plasmid lengths. This is expected if the first polyadenylation/cleavage site fails to function and the second or

third one encountered in the array is utilized. One such RNA species, expected length plus two plasmid lengths, can be seen migrating above the endogenous MAP mRNA in lanes 4 and 6. Another factor that certainly gives rise to some of the smear is the fact that while most of the transformed plasmids are present in head to tail tandem arrays [25] careful examination of these arrays has shown that there are a number of disrupted plasmids within the array [26]. This will result in some of the chimeric genes being disrupted and producing RNAs of unpredictable sizes. Finally it is possible that this RNA, which contains the non-coding strand from the MAP gene and is presumably not translated, may be unstable. Mixing experiments similar to that shown for the endogenous metallothionein mRNA in figure 3 indicate that the induction ratio of the RNA from the MAP-metallothionein chimeric gene is approximately 30 fold (unpublished data). Observation of the endogenous metallothionein gene's response indicates that it is induced slightly greater than 30 fold in both untransformed cells and in the transformed, selected populations of cells. The probing of identical RNA loadings with an RP49 probe in figure 7b demonstrates that all RNA loadings are equivalent in the uninduced and induced lanes of each population of cells. Therefore, it can be concluded that the vector pRmHa-1 has sequences that are capable of conferring copper inducibility, presumably at the transcriptional level, to exogenous DNA.

DISCUSSION

The experiments presented here indicate that the response to metals of the *Drosophila* metallothionein promoter in S2/M3 cells is similar to the responses seen in the mammalian systems that have been studied. For example, cadmium induction of metallothionein mRNA levels at concentrations less than 30 μ M, and cytotoxicity at higher concentrations accompanied by a less pronounced induction of metallothionein mRNA levels is observed both in our experiments and those of Hamer and Walling [15] working with African green monkey kidney cells. It is interesting to note that the causes of cadmium toxicity and diminution of response are not completely clear but it has been suggested that cadmium may displace zinc in zinc metalloenzymes and interact with

free sulfhydryl groups of other proteins causing a disruption of macromolecular synthesis and cell death [1]. Hamer and Walling [15] also noted that treatment of African green monkey kidney cells with 40 uM cadmium resulted in 70% inhibition of total cell protein synthesis.

The induction of a heat-shock response by the heavy metals copper, cadmium, zinc and mercury has been previously noted in work on chick embryo cells and human foreskin cells in culture [39,40]. In contrast to the situation in vertebrates, cadmium but not copper induces a prolonged heat-shock response as evidenced by the increase in HSP70 mRNA levels. As stated in the results section, copper causes a brief rise in HSP70 mRNA levels which then decrease to background levels after 12 hours of growth in copper containing media. It should be noted, however, that it is possible that the addition of copper to the media results in an altered heat-shock response that does not involve high levels of HSP70 mRNA.

The data presented here on the induction ratio of metallothionein mRNA levels indicate that there is a significant change in the mRNA levels, between 30 and 100 fold. This induction ratio is similar to the 30 fold induction seen in African green monkey cells and cadmium resistant CHO (Chinese hamster ovary) cells [15,12]. Hela cells show a 20-40 fold induction of metallothionein mRNA levels after treatment with zinc [42].

Chimeric genes containing metallothionein promoters have been constructed and analyzed in other systems. These chimeric genes, when transformed into mouse or human cells, show variable induction ratios. The ratios varied from 2 to 40 fold between different lines of transformed cells [43,19]. Data presented here show that two populations of transformed cells both exhibit an induction ratio of approximately 30 fold. We have also constructed other chimeric genes based on the metallothionein promoter and they are likewise highly inducible when transformed into S2/M3 cells (unpublished data).

One final point should be made in reference to the work presented here on chimeric genes. While it is likely that the metallothionein promoter confers metal inducibility upon exogenous

DNA by elevating rates of transcription as has been seen in other systems, our work does not exclude the formal possibility that the 54 bases of metallothionein untranslated leader sequence confers increased, metal induced, stability to the chimeric RNA. Taken together though, the data on induction, toxicity, and heat-shock induced by copper and cadmium, indicate that copper may be an excellent inducer for physiological experiments that use the metallothionein promoter to control expression of chimeric genes in *Drosophila* cells.

ACKNOWLEDGEMENTS

We would like to thank Dr. Gustavo Maroni and his colleagues for providing unpublished information concerning the use of the metallothionein promoter and Dr. Andrea Pereira, Bob Coyne and Nick Brown for critical comments on the manuscript. This work was supported by NIH grants GM35252 and GM29301.

*To whom reprint requests should be sent

REFERENCES

1. Kagi, J.H.R. and Nordberg, M. (1979) Metallothionein, Birkhauser, Verlag, Basel.
2. Olafson, R.W., Abel, K. and Sim, R.G. (1979) Biochem. Biophys. Res. Commun. **89**, 36-43.
3. Yamamura, M., Suzuki, K.T., Hatakeyama, S. and Kubota, K. (1983) Comp. Biochem. Physiol. **75C**, 21-24.
4. Everard, L.B. and Swain, R. (1983) Comp. Biochem. Physiol. **75C**, 275-280.
5. Cherian, M.G. and Goyer, R.A. (1978) Life Sci. **23**, 1-10.
6. Suzuki, Y. and Yoshikawa, H. (1976) Ind. Health **14**, 25-31.
7. Richards, M.P. and Cousins, R.J. (1977) Biochem. Biophys. Res. Commun. **75**, 286-294.
8. Squibb, K.S. and Cousins, R.J. (1977) Biochem. Biophys. Res. Commun. **75**, 806-812.
9. Shapiro, S.G., Squibb, K.S., Markowitz, L.A., Cousins, R.J. (1978) Biochem. J. **175**, 833-840.
10. Anderson, R.D. and Weser, U. (1978) Biochem. J. **175**, 841-852.
11. Ohi, S., Cardenosa, G., Pine, R., Huang, P.C. (1981) J. Biol. Chem. **256**, 2180-2184.
12. Enger, M.D., Tall, L.B. and Hildebrand, C.E. (1979) Nucleic Acids Res. **7**, 271-288.
13. Debec, A., Mokdad, R. and Wegnez, M. (1985) Biochem. Biophys. Res. Commun. **127**, 143-152.
14. Durnam, D.M. and Palmiter, R.D. (1981) J. Biol. Chem. **256**, 5712-5716.
15. Hamer, D.H. and Walling, M.-J. (1982) J. Mol. Appl. Genet. **1**, 273-288.

16. Brinster, R.L., Chen, H.Y., Warren, R., Sarthy, A. and Palmiter, R.D. (1982) *Nature* **296**, 39-42.
17. Stuart, G.W., Searle, P.F., Chen, H.Y., Brinster, R.L. and Palmiter, P.D. (1984) *Proc. Natl. Acad. Sci. U.S.A.* **81**, 7318-7322.
18. Carter, A.D., Felber, B.K., Walling, M.-J., Jubier M.-F., Schmidt, C.J. and Hamer, D.H. (1984) *Proc. Natl. Acad. Sci. U.S.A.* **81**, 7392-7396.
19. Karin, M., Haslinger, A., Holtgreve, H., Cathala, G., Slater, E. and Baxter, J.D. (1984) *Cell* **36**, 371-379.
20. Maroni, G., Otto, E. and Lastowski-Perry, D. (1986) *Genetics* **112**, 493-504.
21. Otto, E., Allen, J.M., Young, J.E., Palmiter, R.D. and Maróni, G. (1987) *Mol. Cell. Biol.* **7**, 1710-1715.
22. Schneider, I. (1972) *J. Embryol. exp. Morph.* **27**, 353-365.
23. Lindquist, S.L., Sonoda, S., Cox, T. and Slusser, K. (1982) *Drosophila Information Service* **58**, 163.
24. Wigler, M., Pellicer, A., Silverstein, S., Axel, R., Urlaub, G. and Chasin, L. (1979) *Proc. Natl. Acad. Sci. U.S.A.* **76**, 1373-1376.
25. Bourouis, M. and Jarry, B. (1983) *EMBO J.* **2**, 1099-1104.
26. Moss, R. (1985) *Doctoral Thesis, Harvard University.*
27. Kwan, S.-P., Wood, T.G. and Lingrel, J.B. (1977) *Proc. Natl. Acad. Sci. U.S.A.* **74**, 178-182.
28. Maniatis, T., Fritsch, E.F., Sambrook, J. (1982) *Molecular Cloning, Cold Spring Harbor, New York.*
29. Church, G.M., Gilbert, W. (1984) *Proc. Natl. Acad. Sci. U.S.A.* **81**, 1991-1995.
30. Denhardt, D. (1966) *Biochem. Biophys. Res. Commun.* **23**, 641-652.
31. Rigby, P.W.J., Dieckmann, M., Rhodes, C. and Berg, P. (1977) *J. Mol. Biol.* **113**, 237-251.
32. Savakis, C., Koehler, M.M.D. and Cherbas, P. (1984) *EMBO J.* **3**, 235-243.
33. Thomas, P.S. (1980) *Proc. Natl. Acad. Sci. U.S.A.* **77**, 5201-5205.
34. Auffray, C. and Rougeon, F. (1980) *Eur. J. Biochem.* **107**, 303-314.
35. Yanisch-Perron, C., Vieira, J. and Messing, J. (1985) *Gene* **33**, 103-119.
36. Vaslet, C.A., O'Connell, P., Izquierdo, M., Rosbash, M. (1980) *Nature* **285**, 674-676.
37. Goldberg, D.A. (1980) *Proc. Natl. Acad. Sci. U.S.A.* **77**, 5794-5798.
38. Kreitman, M. (1983) *Nature* **304**, 412-417.
39. Levinson, W., Oppermann, H. and Jackson, J. (1980) *Biochim. Biophys. Acta* **606**, 170-180.
40. Hightower, L.E. and White, F.P. (1981) *J. Cell Physiol.* **108**, 261-276.
41. Goldstein, L.S.B., Laymon, R.A. and McIntosh, J.R. (1986) *J. Cell Biol.* **102**, 2076-2087.
42. Karin, M., Anderson, R.D., Herschman, H.R. (1981) *Eur. J. Biochem.* **118**, 527-531.
43. Mayo, K.E., Warren, R. and Palmiter, R.D. (1982) *Cell* **29**, 99-108.