



Respiration hastens maturation and lowers yield in rice

V. Sitaramam, R. Bhate, P. Kamalraj and S. Pachapurkar

Department of Biotechnology, University of Pune, Pune – 411 007, India

ABSTRACT

Role of respiration in plant growth remains an enigma. Growth of meristematic cells, which are not photosynthetic, is entirely driven by endogenous respiration. Does respiration determine growth and size or does it merely burn off the carbon depleting the biomass? We show here that respiration of the germinating rice seed, which is contributed largely by the meristematic cells of the embryo, quantitatively correlates with the dynamics of much of plant growth, starting with the time for germination to the time for flowering and yield. Seed respiration appears to define the quantitative phenotype that contributes to yield via growth dynamics that could be discerned even in commercial varieties, which are biased towards higher yield, despite considerable susceptibility of the dynamics to environmental perturbations. Intrinsic variation, irreducible despite stringent growth conditions, required independent validation of relevant physiological variables both by critical sampling design and by constructing dendrograms for the interrelationships between variables that yield high consensus. More importantly, seed respiration, by mediating the generation clock time via variable time for maturation as seen in rice, directly offers the plausible basis for the phenotypic variation, a major ecological stratagem in a variable environment with uncertain water availability. Faster respiring rice plants appear to complete growth dynamics sooner, mature faster, resulting in a smaller plant with lower yield. Counter to the common allometric views, respiration appears to determine size in the rice plant, and offers a valid physiological means, within the limits of intrinsic variation, to help parental selection in breeding. [**Physiol. Mol. Biol. Plants** 2008; 14(3) : 253-271] E-mail : sitaramamv@gmail.com

Key words : Meristematic cells, allometry, flowering, branching

Abbreviations : J_o , nmoles of oxygen consumed.min⁻¹.plant⁻¹, specified for individual part of the plant; t_g , time taken for 50% germination; t_f , time taken for 50% flowering; t_{lai} , time taken for appearance of *i*th leaf ; t_{lgi} , time taken for 50% growth of the *i*th leaf

INTRODUCTION

Growth of rice (*Oryza sativa* L.) seedling is characterized primarily by two major events of meristematic growth, the first at the time of germination and the second at the time of flowering (Okubo, 2000). The differentiation for the early vegetative growth occurs during embryogenesis itself (Sato *et al.*, 1996). The time for maturation (flowering) [induced by a florigen from leaves e.g. in *Arabidopsis* and possibly in rice and other plants (Abe *et al.*, 2005)] determines the duration available for the plant to harvest the photosynthate in its life span and thereby correlates well with plant height and grain yield. Respiration is considered to affect biomass as it uses up the reserves/photosynthate (Cannell and Thornley, 2000). However, in organisms with well-

coupled respiration, the demand due to cell proliferation, hence growth, is more likely to render respiration supportive of biomass generation (Smith, 1995) rather than its loss. Therefore we addressed the question, whether respiration has any ontogenic role beyond the usual models of plant energetics (Cannell and Thornley, 2000), by a careful comparison of the detailed dynamics of plant growth with respiration with attention to variations intrinsic to growth processes, in rice.

The relationship between these various parameters of different parts of the seedling/plant involve several processes such as cell division, elongation, structure formation etc., which could be a simple monotonic cascade or could be mutually independent determinate growth of each part. A major consideration is the variation, intravarietal as well as intervarietal, which requires specific statistical designs that exploit the intrinsic variation itself as a tool to understand the

Correspondence and Reprint requests : V. Sitaramam

interrelationships. Also the ability to predict yield as a phenological variable will be limited by this intrinsic variation, which sets absolute limits to the prediction, regardless of the methodology used. However, the physiological determinants can be assessed even in the face of variation, given due care in the statistical models adopted. Respiration in seeds itself varies which could be effectively used to design experiments. The results obtained here show that the life stages defined by the time constants (t_g , t_f , t_{gi} etc., *vide infra*) dominate the interrelationships between various parts. Respiration in seeds (necessarily 'dark', owing to lack of photosynthetic ability), hence meristematic respiration, contributes to the control of the time for maturation and secondarily yield, in a simple cascade of growth dynamics in a monocot, rice.

The heart of the matter in the prediction of yield is not simply finding good correlation but assessing what traits are more susceptible to variation to weed out the confounding variables. It brings us to reconsider how to define the phenotype, mass based or time based. The conventional wisdom arises from the need to explain the macro-phenomena from the micro-attributes. The classic approach in genetics of the triad of genotype-phenotype-environment and interactions thereof constitutes a macro description. This is being attempted to be reduced to the micro-realm, e.g., genomics - proteomics with component transcripts, metabolons etc., to offer an explanatory platform for the genetic paradigms (Glass *et al.*, 2006). The results are often illuminating while handling single genes and their inheritance. The parallel efforts with multigenic quantitative traits is to identify the quantitative trait loci and attempt to do genetics as well as genomic analysis on these loci (Nishimura *et al.*, 2005; Yin *et al.*, 2004). The phenotype is considered a result of, or traceable to, mass fluxes such that metabolism or function accounts for the observed changes associated with phenotypic transformation of the *ith* phenotypic measure (as reflected in its mass), *ceteris paribus*,

$$\phi(m)_i = \int_{t=i-1}^{t=i} \frac{\partial S}{\partial t} dt \quad \dots\dots (1)$$

where S refers to the substrate catalyzed (mass consumed). This treatment is simply incapable of handling time scales (which is already normalized while computing the velocities), nor is it intended to in the first approximation.

The alternative is time. A clock is a dynamical system and, as any linear or non-linear device measures the

elapsed time, real or event related, any dynamical system can also serve as a clock. Heterochrony has been used in many contexts in biology (Klingenberg, 1998) emphasizing time. The biological time in plant growth can be defined at different levels starting with cell division forming the basis of nearly exponential growth of each and every plant part; the second relates to branching and the third to the life cycle or the generation time. Time for maturation is the measure of the generation time in an annual. Thus the phenotypic description (as life stage in time achieved), *ceteris paribus*, is equally served thus:

$$\phi(t)_i = \tau_{i-1} + \int_{m=0}^{m=m_c} \frac{\partial t}{\partial S} .dS \quad \dots\dots (2)$$

such that the *ith* phenotype is defined as the acquisition of a critical mass, m_c , in a clock time of t_i , adjustable by the rate processes that convert the mass, m.

The critical distinction is in what to measure... if the phenotype is measured by mass specific processes, as the heart of quantitative trait identification, one set of strategies follow. If time is the foundation of developmental biology, then dynamics would form the heart of measurement for plant growth and yield. Despite heroic attempts at measurements of plant growth (Causton and Venus, 1981), a concrete synthesis towards an understanding of yield has not materialized. We know a priori that derivatives (as in rate processes) enhance variation while the asymptotes (e.g., maximal mass/length of a leaf) tend to have less variation. Specifically, the distinction between the mass-based and time-based approaches *in relation to variance* has not been clearly delineated, a major focus of the current work.

MATERIALS AND METHODS

The phenological characteristics related to all the commercial varieties for which nuclear stock seeds of in-bred lines were available (n = 24) were defined prior to their release by the Directorate of Rice Research, Hyderabad, India. Yield (tonnes/ha), time for flowering (t_f , (d, for 50% of the plants)) and plant height (cm) correlated well in these varieties as expected (Fig. 1). Interrelationships were determined by Reduced Major Axis method (Sokal and Rohlf, 1995; Falster, 2003).

Growth models

The growth measurements are derived from growth models of intrinsically independent parts, i.e., each part

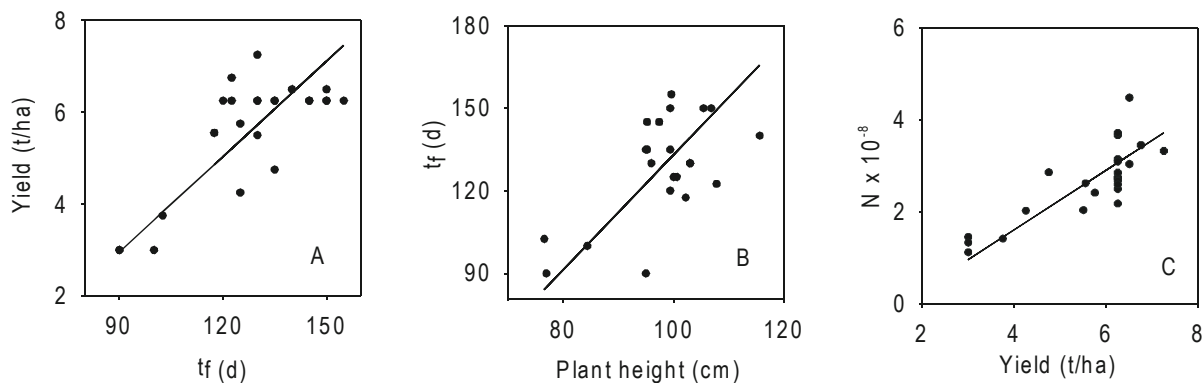

Fig. 1. Physiological correlation in 24 varieties of rice. Correlation between yield (tonnes per hectare) (5.59 ± 1.26), time for 50% flowering (t_f , days), ($128 + 18.2$), plant height (cm) (97.9 ± 9.1) and seed number (N , per hectare $2.58 \times 10^8 + 0.82 \times 10^8$). Data of 24 commercially released varieties of rice from Directorate of Rice Research (DRR), Hyderabad, India. Plant height was based on Kharif field data, 2002, Courtesy, DRR. Breeder quality nuclear stock seeds, at $\geq 98\%$ germination, weighed ($n = 40-45$) to obtain yield as number of seeds. Analysis of slope by reduced major axis (RMA): A. yield = $0.0692 \times t_f - 3.271$, $r = 0.7835$, $P < 0.001$, $n = 24$; B. $t_f = 2.09 \times (\text{plant height}) - 76$, $r = 0.627$, $P < 0.002$, $n = 22$; C. $N = 6.66 \times 10^7 \times (\text{yield}) - 1.1 \times 10^8$, $r = 0.8136$, $P < 0.001$, $n = 24$. Seed weight (mg) (21.9 ± 3.5) exhibited no correlation to with any of these variables in these 24 varieties.

grows independent of the other, e.g., the logistic growth curve and the Richard function which accommodates a greater degree of non-linearity (Causton and Venus, 1981). Interdependent growth models can be devised (e.g., Appendix I) to handle energy partitioning and ascribe the growth achieved by each part as the result of competition with another part, e.g., each leaf or bud in a monocot for transported nutrients, equivalent of pruning in horticulture (Jacobs and Suthers, 1974).

The logistic growth curve,

$$y = \frac{a}{1 + e^{\left[-\left(\frac{t-\tau}{b}\right)\right]}} \quad \text{..... (3)}$$

where, a represents of the maximal value ($y_{\max(i)}$), the asymptote in each measured variable (y) and τ , the time taken for $y = 0.5a$ and b , a (rate-related) constant, was adequate for the experiments reported here by accounting for $\geq 99\%$ variance in all data sets. Various life stages in the early development of the seed, which are largely determinate, can be defined representing τ in the logistic relationship (Equation 3) variously, e.g., as t_g , the time for 50% germination, $t_{lg(i)}$, the time for 50% of length (the dominant axis for growth in rice that permits non-destructive measurements) achieved by the i th leaf. Time for appearance of each leaf could also be directly assessed as $t_{la(i)}$. Subsequent to this determinate growth, the time for flowering, t_f , in 50% of the plants is a comparable measure for maturation. The data was

fitted using Marquardt-Levenberg algorithm (Sigma Plot, SPSS, version 9), which yields an estimate of the deviation associated with the fit.

Germination

Germination, %, was determined using non-floating seeds of individual cultivars in Arnon and Hoagland's (Hoagland and Arnon, 1950) nutrient solution at (29-30) °C ($n = (193 + 34)$) on blotting papers wetted with the same solution. % Germination was determined at intervals of 3 h up to 60 h or 100%, whichever was earlier. In all varieties, % germination (y) versus time (t) fitted the logistic Equation 3 ($r \geq 0.998$) and the residuals were random confirmed by using Minitab (version 9.2, 1993, minitab Inc., PA).

Germination at different atmospheric pressures

The seeds (variety Aditya ($t_f = 90$ d), Tulasi ($t_f = 100$ d), Vikas ($t_f = 120$ d), Ajaya ($t_f = 130$ d), Mandyavijay ($t_f = 140$ d) and Salivahana ($t_f = 150$ d)) were grown in Arnon-Hoagland's medium, pH 5.6, under low pressure (obtained with a vacuum pump, (69-71) mm Hg less than control) and control seedlings were kept open to atmosphere. The partial pressure of oxygen was enhanced ~ 25 times the normal partial pressure of oxygen, at ~ 20 mm Hg greater pressure, with a balloon filled with pure oxygen attached to the mouth of the glass bottle in which the seeds/seedlings were grown. The pressure was monitored at least twice a day using

APPENDIX I

Fig 14. shows that the energy produced by various means from seed to photosynthesis along with the transported nutrients, oxygen and water yields the biomass due to growth by cell division elongation etc. and is susceptible to environmental influences. The output of the electron transport chain (ETC), as reducing equivalents and ATP is transformed into growth process with output y , which in turn is transformed into output, mass. The model implies that after an initial delay of t_{lg} , the plant part at P+2 level (e.g., 3rd leaf) begins to consume the energy for its growth which in turns halts the growth of the part P+1, or the 2nd leaf, resulting in the a sigmoid growth curve variously described. By excising any part (leaf) early enough should promote the growth of the earlier or the subsequent part (leaf, which is the heart of the energy partition model.

The model can be formally represented thus: the growth of each part of the plant exhibited a common and specific relationship: the initial growth (f_g) was indeed exponential, invariably followed by a correspondingly exponential inhibition of the process (f_2-f_1), an invariant pattern in all structural parts studied. The self limiting growth of each part is best seen in individual measurements, average measurements being complicated by variations, reflecting some threshold for the second process perceived in the experimental data, i.e.,

$$\begin{aligned} f_g &= f_1 && \dots t \leq t_0 \\ &= f_2 && \dots t \geq t_0 \\ &= f_1 + (f_2-f_1) && \dots t \geq t_0 \end{aligned}$$

More explicitly,

$$\begin{aligned} f(t) &= \beta(e^{at}-1) && \dots 0 \leq t \leq t_0 \\ &= \beta (e^{at_0} - 1) + \alpha [1 - e^{-b(t-t_0)}] && \dots t \geq t_0 \end{aligned} \quad \text{..... Eq. 1.1}$$

and since the C^1 function would be smooth and continuously differentiable,

$$\alpha = \beta (a/b) e^{-at_0}$$

where β has dimensions of length. If $f(t_0)=M/2$, where M is the maximal value of f ,

$$\begin{aligned} f(t) &= [M/2(e^{at_0}-1)] (e^{at}-1) && \dots t \leq t_0 \\ &= (M/2)+(M/2)[1-e^{-b(t-t_0)}] && \dots t \geq t_0 \end{aligned} \quad \text{..... Eq. 1.2}$$

where

$$ae^{at_0} = b(e^{at_0}-1)$$

The dimensions are

$$f(t) = L, \text{ length}, a = t^{-1}, \beta = L, t_0 = t, \alpha = L, b = t^{-1}.$$

The growth data was fitted to the model adapting a minimization package 'Minuit', of the program library (see <http://wwwasdoc.web.cern.ch/wwwasdoc/minuit/minmain.html>). The programme yields data on t_{lg} , y_c , y_{max} , a and b .

a mercury manometer and adjusted using a vacuum pump for low pressure and refilling with oxygen for oxygen at higher pressure.

Growth measurements

The plantlets were kept under constant illumination of $15 \mu\text{mol}\cdot\text{s}^{-1}\cdot\text{m}^{-2}$ using fluorescent lamps uniform within 5% (measured with LI-COR LI-189 with LI-190SA quantum sensor), in a desiccator with water for maintaining 100% humidity. The plant length was measured in terms of shoot length and length of upto first four leaves, at $8 (\pm 1/2)$ h intervals by using overhead projector with a magnification of $\times 7.5$. The laboratory measurements are defined based on Eq.3, as illustrated in Fig. 2.

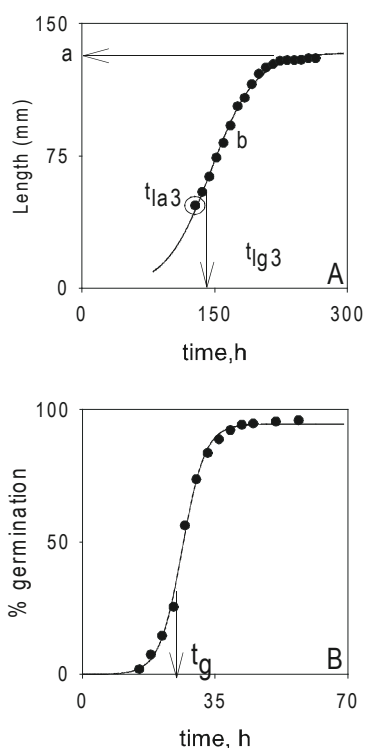

Fig. 2. Definition of growth parameters. Rice seedlings (variety Tulasi, $n=35$) growth grown in $(29-29.5)^\circ\text{C}$ under constant fluorescent lamp light at $(15 \mu\text{mol}\cdot\text{s}^{-1}\cdot\text{m}^{-2})$ in a desiccator for keeping at 100% humidity in Arnon-Hoagland's medium at $\text{pH}=5.6$. A. data for third leaf illustrate t_{la3} (128 h) as the first observable time point at the measured height from the seed. t_{lg3} (145 ± 0.67)h was derived for each leaf from Eq.3 (vide text). a, represents the asymptote y_{max} (133.4 ± 0.94)mm for that leaf. b(25.3 ± 0.87) reflects the inverse of steepness of the slope. B. %germination was plotted for 200 randomly selected seeds and t_g (26.3 ± 0.195)h was computed for eq.1 for 50% germination (t_g). Filled circle, data; continuous line, theoretical fit to (the logistic) Eq. 3.

Measurement of respiration in rice seedlings using constant pressure manometry (Slater, 1967)

Seeds of rice were germinated in Arnon and Hoagland's nutrient solution (with added NaCl where required, as in Fig 6A) for (48 ± 2) h at $(30 \pm 2)^\circ\text{C}$ in an environmental shaker/incubator. Germinated seeds ($\sim 1.5 \text{ g}\cdot\text{flask}^{-1}$) were weighed and transferred to respiratory flasks containing 3mL of 10 mM sodium phosphate buffer, $\text{pH} 7.4$. Fluted filter paper was placed in the central well of the flask containing 0.2mL of 10% KOH, to enhance area of absorption for CO_2 . The rate of respiration was expressed as nmoles of oxygen consumed $\text{min}^{-1}\cdot\text{seed}^{-1}$ as well as g^{-1} of seeds. The measurements of rate of respiration were continued till the sampling ($n \geq 5$) yielded regression better than $r = 0.999$, without exceptions.

Measurement of growth and respiration in single seeds

Seeds of variety Vikas (total 72 seeds were selected from 16 class intervals to obtain a uniform distribution in weight, *vide infra*) were soaked in 100 μL Hoagland's medium each for 48h to facilitate germination. Consumption of oxygen each seed was measured polarographically, using Oxygraph (Gilson, USA Model 5/6) in 1.8mL of 10mM Sodium Phosphate buffer, $\text{pH} 5.6$, at 30°C . The germinating seeds were suspended in plastic tips in glass tubes with medium, to ensure aeration, illuminated as above, to obtain growth of the root, shoot and leaf as length, every 6 h. interval without drying. After 16 days, by which time the growth upto 4th leaf was measured, the weight of roots, shoot and leaves of individual plantlets were recorded and their rate of oxygen consumption was measured by using the Gilson oxygraph after ensuring lack of interference due to light (i.e., dark respiration).

Seed selection

Respiration in rice was seen to show a direct relationship to the weight of the seeds (Fig 3). Since the study focuses on the relationship of seed respiration to growth and yield, three kinds of statistical design were used (Fig. 4). In 960 seeds of variety Vikas, standard deviation of individual weights of seeds (average seed weight, 22.2 mg) did not exceed 0.2 mg in a sixuplicate measurement on each seed and was of the order of 0.065 mg for replicates among 960 seeds, using an electronic balance (Fisher Scientific Co.):

1. Random (R) design. Randomly selected seeds were used in all experiments; seeds were stirred and not shaken prior to sampling to avoid size bias similar to the Brazil nut effect (Rosato *et al.*,

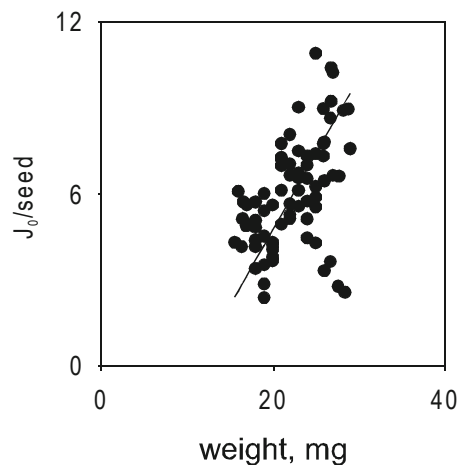

Fig. 3. Seed weight (dry) vs. J_0 in germinating seeds. Respiration per seed was determined polarographically as defined in the text for single seeds. Seeds of variety Vikas were used from the uniform distribution for the respiration measurements (*vide* fig 4). Analysis of slope by reduced major axis, seed wt = $0.531 \times J_0 - 5.82$; $n = 73$, $r = 0.467$, $P < 0.001$.

1987). Randomly selected, 960 seeds were independently weighed and the frequency distribution was determined e.g., Tulasi, (24.3 ± 2.45) mg, Vikas, (22.2 ± 2.14) mg.

2. Low variance (M) design: The mode of the distribution yielded nearly 200 seeds, aliquots of which were used to measure the effects of temperature and pressure at the lowest possible variance in seed weight ($n=35$ in each set, Tulasi (25.1 ± 0.05) mg, Vikas, (23.03 ± 0.05) mg).
3. Maximized variance (U) design. For intra-varietal differences, six seeds from the larger end of each weight class interval including the extremes were used to obtain a more uniform distribution maximizing variance, e.g., Vikas, $n = 73$, (22.3 ± 3.62) mg.

Subsets of seeds which did not grow (e.g., following polarographic measurements of oxygen due to possible injury to the radicle) were tested for possible bias by 't' test and were seen to be indistinguishable from the growing seeds in terms of their weight and rate of respiration.

RESULTS

The experimental logic is based on the reasonable presumption that whatever properties are discernible in a seed will continue to be correlated to each growing

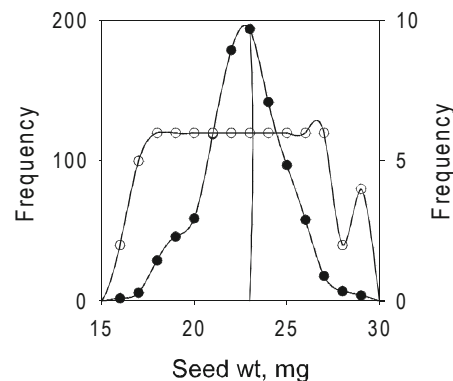

Fig. 4. Statistical design for selection of seeds. Randomly selected, 960 seeds were independently weighed and the frequency distribution was determined (filled circle) e.g., Vikas, (22.2 ± 2.14) mg (R-design). The mode of the distribution (vertical line) yielded nearly 200 seeds, aliquots of which were used to measure the effects of temperature and pressure $n=35$ in each set, (23.03 ± 0.05) mg (M-design). Uniform distribution by selecting six largest seeds from each class interval including the extreme class intervals as available (open circle) (U-design).

plant part, but with increasing variance with growth of the plant, throughout in the seedling stage, ultimately reflecting in the larger variance of the yield. This would be in line with the expectation of isometric relationships in the juvenile (growing forms) in which interrelationships are within reasonably linear ranges between different parts. The essence of the design is to capture the interrelationships as well as the variance at each and every life stage of each and every part, under strict laboratory conditions.

Germination

The earliest measurable life stage would be germination (t_g) exclusively arising from respiration (nmoles of oxygen consumed $\cdot \text{min}^{-1}$ (J_0)) of the stored food. The relative contributions per seed at 24 h germination, ($n=6$) was 38 % ($(0.697 \pm 0.33) \mu\text{mol} \cdot \text{min}^{-1} \cdot \text{g}^{-1}$) from the endosperm and 61 % ($(8.82 \pm 3.2) \mu\text{mol} \cdot \text{min}^{-1} \cdot \text{g}^{-1}$) from the embryo itself (specific activity in parentheses) determined in one representative variety, Vikas (R-design). At normal atmospheric pressure, the rate of respiration is contributed to both by the endosperm and the embryo, while sum of these individual rates is more than the total seed respiration (Fig. 5). Thus, it was clear that the embryo has some degree of diffusional limitation, which may be overcome with high pressure. This in turn could manifest in altered growth rates. The high specific activity of respiration of the seed arising from the embryo *per se* helped reveal the relationship,

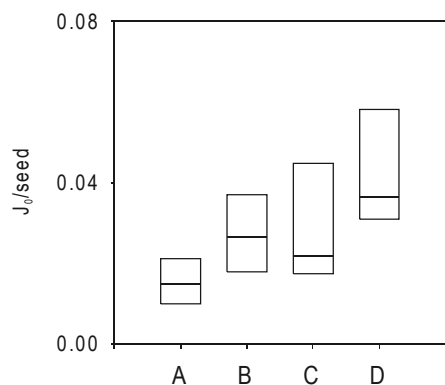

Fig. 5. Respiration by parts of rice seed. Random seeds of variety Vikas were used for the respiration measurements ($\mu\text{mole}\cdot\text{min}^{-1}\cdot\text{seed}^{-1}$). A. endosperm respiration, B. embryo respiration, C. total seed respiration and D, A+B. The relative contributions per seed at 24 h germination, (n=6) was 38 % ($(0.697 \pm 0.33) \mu\text{mol}\cdot\text{min}^{-1}\cdot\text{g}^{-1}$) from the endosperm and 61 % ($(8.82 \pm 3.2) \mu\text{mol}\cdot\text{min}^{-1}\cdot\text{g}^{-1}$) from the embryo itself (specific activity in parentheses) determined in one representative variety, Vikas. The box plot shows the median and 10th and 90th percentile of the coefficient of variation of each variable.

$$t_g = t_{\min} + \frac{b_t}{J_o} \quad \dots\dots (5)$$

where t_{\min} is a constant, t_g , time for germination, achieved faster by the faster respiring seeds, intrinsic or by controlling the rate of respiration and germination by the addition of NaCl (osmoticum) (Sitaramam and Madhavarao, 1997; Mathai *et al.*, 1993) (Fig. 6A). The coefficient, b_t , in units of nmoles of oxygen consumed.seed⁻¹, reflects the energy required for germination. Inter-varietal variation partially masked the exact relationship as in Equation 5 when a number of varieties were tested, though the negative trend was highly significant and could be readily seen (Fig. 6B).

The seed respiration and t_g both correlated well with the phenological traits t_f , plant height and yield (Fig.6C-F). Table 1 gives the complete correlation matrix between the phenological data (Fig 1) and laboratory data (Fig 6). Statistical significance alone is not adequate and some insight into the nature of variation that confounds the interrelationships among the physiological variables is required to understand the relevance of respiration as a possible predictor for yield.

Table 1. Correlation matrix between seed respiration and various other phenological characteristics.

	J_o/g	$J_o/seed$	Seed wt	t_g	Height	t_f	Yield
$J_o/seed$	0.69						
Seed wt	-0.25	0.47					
t_g	-0.49	-0.39	0.06				
Height	-0.11	-0.6	-0.58	0.18			
t_f	-0.29	-0.44	-0.24	0.41	0.63		
Yield	-0.33	-0.51	-0.23	0.43	0.7	0.78	
Seed no	-0.01	-0.55	-0.72	0.25	0.79	0.66	0.81

Seed respiration expressed as nmoles of oxygen consumed.min⁻¹.seed⁻¹ ($J_o/seed$), or gram seed⁻¹ (J_o/g). Seed weight obtained on weighing ~1 gm seeds divided by no. of seeds. t_g represents time (h) taken for 50% germination. t_f represents time (d) taken for 50% flowering, Heights are in cm., and yield expressed in tonnes.hectare⁻¹. Analysis of slope for trends by reduced major axis (RMA); correlation better than 0.05 represented by bold numbers ($\sim r \geq 0.38$ for $n \geq 20$). ($J_o/seed$)=($0.04 \times (J_o/g)$) -0.84, $r=0.69$, $P<0.001$, $n=25$; t_g (h) =(-0.15 \times (J_o/g)) + 62.1, $r=0.49$, $P<0.02$, $n=25$; Seed weight = ($3.36 \times (J_o/seed)$)+2.53, $r=0.47$, $P<0.01$, $n=24$; Plant height = (-8.6 \times ($J_o/seed$)) + 148, $r=0.60$, $P<0.004$, $n=22$. t_f = (-17.4 \times ($J_o/seed$))+227, $r=0.44$, $P<0.03$, $n=25$; Yield = (-1.2 \times ($J_o/seed$)) + 12.5, $r=0.51$, $P<0.02$, $n=24$. Seed number = (-7.8⁰⁷ \times ($J_o/seed$))+7.1⁰⁸, $r=0.55$, $P<0.005$, $n=24$; Plant height = (-2.5 \times seed weight) + 153, $r=0.58$, $P<0.005$, $n=22$. Seed number = (-2.38⁰⁷ \times (seed wt))+7.7⁰⁸, $r=0.72$, $P<0.001$, $n=24$; t_f =(4.42 \times t_g)-31.6, $r=0.41$, $P<0.05$, $n=25$; Yield=(0.36 \times t_g)-5.86, $r=0.43$, $P<0.05$, $n=24$; t_f =(2.09 \times Plant height)-76, $r=0.62$, $P<0.002$, $n=22$; Seed number = ($9^{06} \times$ Plant height)+6.3⁰⁸, $r=0.79$, $P<0.001$, $n=22$; Yield=(0.136 \times Plant height)-7.81, $r=0.69$, $P<0.001$, $n=22$; Yield=(0.07 \times t_f)-3.27, $r=0.78$, $P<0.001$, $n=24$; Seed number = ($4.5^{06} \times$ t_f)-3.1⁰⁸, $r=0.65$, $P<0.001$, $n=24$; Seed number = ($6.5^{07} \times$ yield)-9.9⁰⁷, $r=0.81$, $P<0.001$, $n=24$.

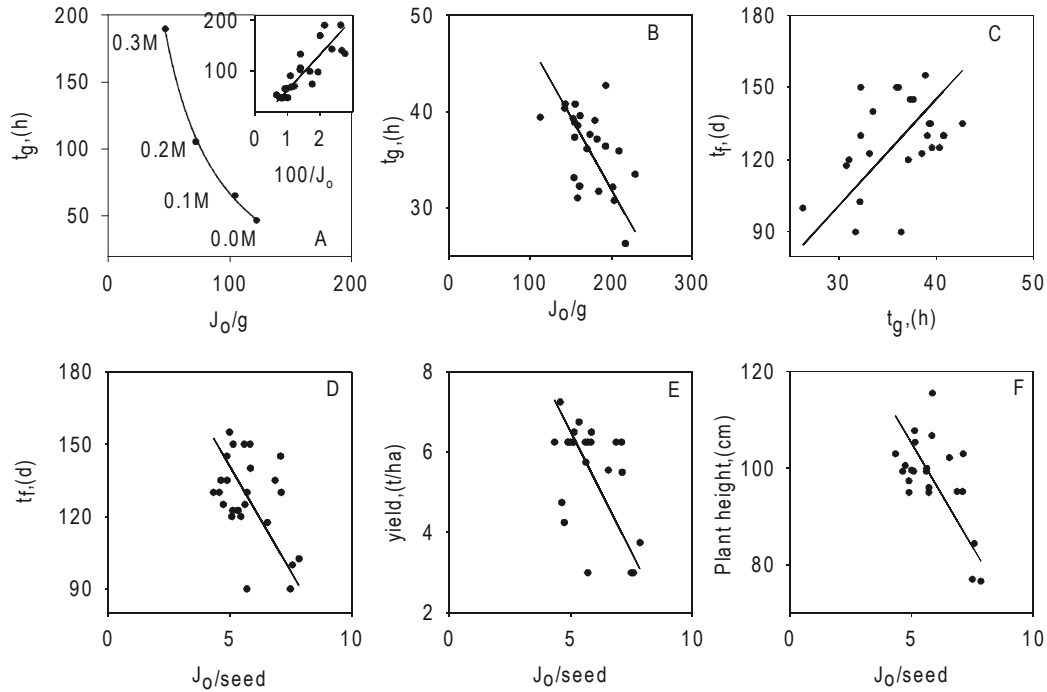

Fig. 6. Phenological correlates with seed respiration. Yield (tonnes per hectare), rate of respiration, J_0 , (nmoles of oxygen consumed. min^{-1}) in germinating seeds (specific activity calculated g^{-1} wet weight of seed, as well as seed^{-1}), time for 50% germination (t_g , h), time for 50% flowering (t_f , d), and plant height (cm). A. t_g at different NaCl concentration and corresponding specific rates of respiration (J_0/g) of variety, Aditya; $t_g = -40.9 + (10764/J_0/g)$, $r = 0.9991$, $P < 0.001$, $n = 4$ (Sigmaplot 5.0). The inset refers to 6 varieties of rice, including Aditya at comparable concentrations of NaCl, such that $100/J_0$ was plotted against t_g . Analysis of slope for trends by reduced major axis (RMA); $t_g = (69.8 \times J_0^{-1}) - 2.03$, $r = 0.858$, $P < 0.0001$, $n = 25$. B. t_g (h) = $-0.15 \times (J_0/g) + 62.1$, $r = 0.489$, $P < 0.02$, $n = 25$; C. $t_f = 4.42 \times t_g - 31.6$, $r = 0.4064$, $P < 0.05$, $n = 25$; D. $t_f = -17.4 \times (J_0/seed) + 227$, $r = 0.4404$, $P < 0.03$, $n = 25$; E. yield = $-1.2 \times (J_0/seed) + 12.5$, $r = 0.513$, $P < 0.02$, $n = 24$. F. Plant height = $-8.6 \times (J_0/seed) + 148$, $r = 0.5974$, $P < 0.004$, $n = 22$. Yield and t_f data were from data on commercial varieties released by Directorate of Rice Research (DRR), Hyderabad, India. Plant height data for these were from Kharif field data, 2002, Courtesy DRR.

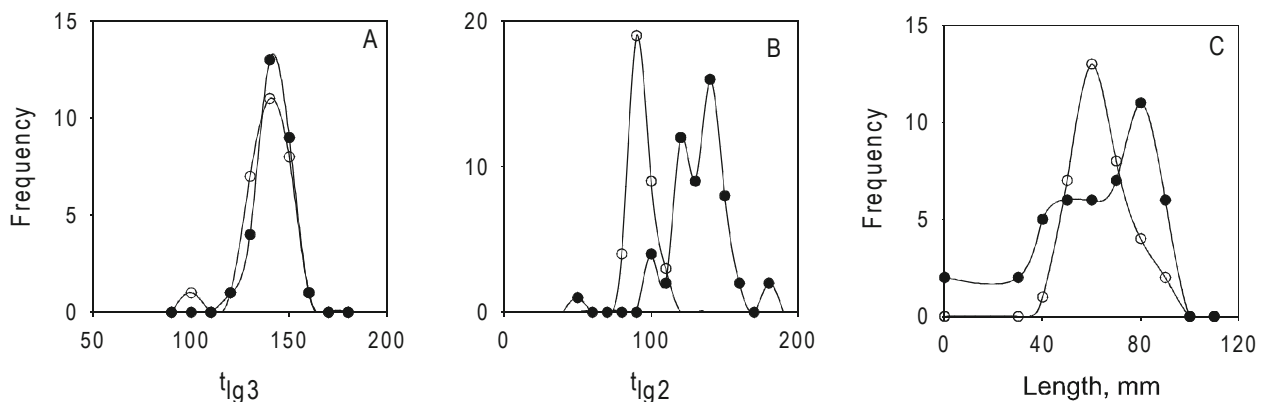

Fig. 7. Variation in growth measurement depending on the seed sampling design. Frequency distribution of time taken for the growth (t_{lg3} , time taken for 50% growth of the leaf), (A and B) and growth of leaf length of rice seedlings. A: t_{lg3} of mode (unfilled circle) and random (filled circle) distributed seeds, Variety, Tulasi. B: t_{lg2} time taken for the growth of random (unfilled circle) and uniform (filled circle) distributed seed, Variety Vikas and C. length of rice seedlings at random (unfilled circle) and uniform (filled circle) distributed seed, Variety, Vikas.

Table 2. Complete Correlation matrix between seed respiration and various growth characteristics of rice seedling grown in ambient temperature.

	Seed wt.	Seed J ₀	Root J ₀	Shoot J ₀	Leaf J ₀	t _{la1}	t _{la2}	t _{la3}	t _{lg1}	t _{lg2}	t _{lg3}	b ₁	b ₂	b ₃	Y _{max1}	Y _{max2}
Seed J ₀	0.516															
Root J ₀	0.631	0.42														
Shoot J ₀	0.222	0.085	0.009													
Leaf J ₀	0.47	0.2	0.348	-0.179												
t _{la1}	-0.221	-0.468	-0.06	-0.17	0.131											
t _{la2}	-0.084	-0.481	0.057	-0.266	0.246	0.75										
t _{la3}	-0.012	-0.127	-0.004	0.134	0.114	0.094	0.183									
t _{lg1}	-0.01	-0.331	-0.059	-0.196	0.345	0.75	0.613	0.328								
t _{lg2}	0.172	-0.219	0.045	-0.015	0.4	0.391	0.422	0.446	0.654							
t _{lg3}	0.204	0.054	0.041	0.069	0.142	0.205	0.189	0.54	0.293	0.454						
b ₁	0.221	0.1	-0.003	-0.03	0.394	-0.057	-0.034	0.433	0.365	0.573	0.295					
b ₂	0.031	0.386	0.221	0.319	0.084	-0.414	-0.494	0.459	-0.365	-0.192	0.183	0.087				
b ₃	0.216	0.342	0.088	0.067	-0.139	-0.133	-0.076	-0.03	-0.199	-0.151	0.638	-0.045	0.038			
Y _{max1}	0.034	0.059	-0.231	0.111	-0.172	-0.116	-0.363	-0.073	0.026	0.402	0.036	0.219	-0.02	-0.12		
Y _{max2}	0.227	0.191	-0.195	0.18	-0.265	-0.366	-0.482	-0.377	-0.214	0.268	-0.089	0.127	-0.024	-0.087	0.916	
Y _{max3}	0.142	-0.148	-0.041	0.013	-0.078	0.152	0.086	-0.502	0.152	0.005	0.002	-0.113	-0.505	0.186	0.316	0.469

Correlation matrix of rate of respiration, J₀, of seed, root, shoot and leaves (nmoles of oxygen consumed/min⁻¹) and various growth characteristics. correlation better than 0.05 represented by bold numbers (~ r ≥ 0.30 for n ≥ 40); t_{la} represents time taken for appearance of leaf (t_{la1}, t_{la2} and t_{la3} represents the first leaf, second leaf and third leaf and third leaf appearances) and t_{lg} represents time taken for 50% growth of the leaf (t_{lg1}, t_{lg2} and t_{lg3} represents the first leaf, second leaf and third leaf 50% growth). 'b' refers to steepness related parameter of the logistic function and Y_{max} refers to the asymptote of growth (length) in each leaf. Bold numbers indicate P < 0.05. Seed J₀ = (0.0005 × seed wt.) - 0.006, r = 0.51, P < 0.001, n = 56. Root J₀ = (0.0003 × seed wt.) - 0.005, r = 0.63, P < 0.001, n = 43. Leaf J₀ = (0.0005 × seed wt.) - 0.007, r = 0.47, P < 0.002, n = 42. Root J₀ = (0.73 × seed J₀) - 1.02, r = 0.42, P < 0.005, n = 43. t_{la1} = (-13.1 × seed J₀) + 174, r = 0.46, P < 0.001, n = 56. t_{lg1} = (-11 × seed J₀) + 179, r = 0.33, P < 0.02, n = 54. t_{la2} = (-11.6 × seed J₀) + 189, r = 0.48, P < 0.001, n = 56. Leaf J₀ = (1.28 × root J₀) - 0.3, r = 0.34, P < 0.02, n = 42. t_{lg1} = (11.7 × leaf J₀) + 59.6, r = 0.34, P < 0.05, n = 42. t_{la2} = (0.89 × t_{la1}) + 35, r = 0.74, P < 0.001, n = 58. t_{lg2} = (0.84 × t_{la1}) + 57.5, r = 0.39, P < 0.005, n = 56. t_{lg2} = (1.01 × t_{lg1}) + 4.37, r = 0.61, P < 0.001, n = 54. t_{lg2} = (1.02 × t_{lg1}) + 23.2, r = 0.65, P < 0.001, n = 54. t_{lg3} = (0.73 × t_{lg1}) + 104, r = 0.33, P < 0.03, n = 43. t_{lg2} = (0.95 × t_{la1}) + 24.3, r = 0.42, P < 0.0012, n = 56. t_{la3} = (0.84 × t_{lg2}) + 66.2, r = 0.44, P < 0.002, n = 43. t_{lg3} = (0.84 × t_{lg2}) + 86.3, r = 0.45, P < 0.002, n = 43. t_{lg3} = (1.01 × t_{la3}) + 19.6, r = 0.54, P < 0.001, n = 43. Seed J₀ = (6.6 × b₂) - 18.372, r = 0.386005, n = 56, P < 0.0033; Seed J₀ = (4.12 × b₃) - 12.386, r = 0.342053, n = 43, P < 0.0248; Shoot J₀ = (10.6 × b₂) - 18.429, r = 0.319374, n = 42, P < 0.0392; leaf J₀ = (5.29 × b₁) - 5.459, r = 0.394968, n = 42, P < 0.0097; t_{la1} = (-0.505 × b₂) + 69.476, r = 0.414729, n = 56, P < 0.0015; t_{la1} = (-0.693 × Y_{max2}) + 109.331, r = 0.36606, n = 56, P < 0.0056; t_{lg1} = (0.393 × b₁) - 26.855, r = 0.36, n = 56, P < 0.001; t_{lg1} = (0.736 × t_{lg3}) + 124.803, r = 0.293258, n = 43, P < 0.0569; b₁ = (2.49 × t_{lg2}) + 94.538, r = 0.573585, n = 54, P < 0.001; b₁ = (1.57 × t_{la3}) + 157.588, r = 0.432435, n = 45, P < 0.003; b₁ = (1.56 × t_{lg3}) + 177.914, r = 0.294958, n = 43, P < 0.0544; Y_{max1} = (-7.56 × t_{la2}) + 194.571, r = 0.363318, n = 56, P < 0.0059; Y_{max1} = (8.18 × t_{lg2}) + 51.219, r = 0.402492, n = 54, P < 0.0026; Y_{max1} = (6.46 × Y_{max2}) - 22.042, r = 0.915969, n = 54, P < 0.001; Y_{max1} = (10.8 × Y_{max3}) - 35.451, r = 0.316228, n = 43, P < 0.0388; t_{la1} = (-0.505 × b₂) + 69.476, r = 0.494, n = 56, P < 0.0015; t_{la1} = (-0.693 × Y_{max2}) + 109.331, r = 0.48, n = 56, P < 0.0056; b₂ = (1.09 × t_{la3}) + 160.943, r = 0.458258, n = 45, P < 0.0015; b₂ = (-1.39 × Y_{max3}) + 117.641, r = 0.504975, n = 43, P < 0.0006; Y_{max2} = (-1.34 × t_{la3}) + 253.372, r = 0.376829, n = 45, P < 0.0108; Y_{max2} = (1.9 × Y_{max3}) - 11.765, r = 0.469042, n = 43, P < 0.0015; t_{la3} = (-1.29 × Y_{max3}) + 325.557, r = 0.501996, n = 43, P < 0.0006; t_{lg3} = (0.554 × b₃) - 99.354, r = 0.637966, n = 43, P < 0.001.

Dynamics of growth of seedlings

a. Intra-varietal differences

Since the initial event of growth, viz., germination, matched closely with the final event of onset of flowering (maturation, t_f), followed by yield, variation needs to be traced to each and every life event that determines the plant growth, leaf by leaf as it were. The intermediate stages of the vegetative growth of individual leaves (shoot) and roots (collectively) based on Equation 3 also were assessed within a variety as well as across varieties. The problem is one of design. Fig 7 shows that the M- and R- sampling designs based on seed weight (i.e., also related to respiration, vide Fig 3), show comparable frequency distributions for leaf growth, while the U-design led to enhanced variation. Thus, U-design in measurements offered excellent scope for examining intra-varietal relationships among physiological variables. Table 2 defines the correlation matrix for the estimates from Equation 3 from various measurements in ambient environment (temperature, (28-34) °C and humidity (~ (60-80) %) using a sample with uniform distribution of seeds (variety Vikas). In these Vikas seeds, $n = 73$, the germinating seeds at 48 h showed a significant relationship between seed weight (x , mg) and seed respiration (y , nmoles. $\text{min}^{-1}.\text{seed}^{-1}$) ($y = 0.531x - 5.82$ by reduced major axis, $r = 0.467$, $P < 0.001$) (Fig. 3). The observed correlation with some later life stages indicates the importance of embryo respiration in these variations. (i.e., critical times measures as t_{ai} and t_{gi} , for each leaf as well as between leaves). Respiration in non-photosynthetic tissues, seed and root, correlated well but not with dark respiration in leaf mass.

b. Inter-varietal differences

Three varieties with the widest possible variation in t_f were chosen and similar experiment on plant growth was conducted, however under more rigorous conditions of temperature ((29.5-30.0) °C) and humidity (100 % throughout) using R-design. Table 3 shows that different life stages and seed respiration conserved the (rank) correlation, but not the rates of growth nor the asymptotic values of growth (y_{max}). Yield already saturated for these varieties; correlation was again better among ‘time-based’ measurements, e.g., t_f with t_g , $t_{lg(2)}$, $t_{la(3)}$, and also b_2 , and among the varieties t_g with $t_{la(3)}$, $t_{lg(2)}$, $t_{lg(3)}$ and b_2 ; $t_{lg(2)}$ with $t_{lg(3)}$ and also b_3 .

Effect of variable partial pressure of oxygen

The influence of respiration on plant growth needed to be determined by directly controlling the rate of

Table 3. Growth parameters of rice seedlings, t_f and yield in 3 varieties at 30°C.

Variety	t_f^*, d	Yield, tonnes/ha	Plant height cm	J_0 , μL of $\text{O}_2/\text{min/g}$ seed	t_g^*, h	t_{la3}^*, h	t_{lg2}^*, h	t_{lg3}^*, h	b_2^*	b_3	$y_{\text{max}2}$	$Y_{\text{max}3}$
Tulasi	100	3	84.4	7.56	26.3	143±8.6	87.2±6.97	145 ± 8.4	17.9±1.9	23.9± 7.3	60.6±8.16	117±15.2
Vikas	123	6.25	107	5.11	33.1	148±9.3	98.3±7.67	158 ± 10.9	17.8±1.29	28.5±5.51	64.8±7.42	151±19
Salivahana	155	6.25	99.6	4.98	38.9	158±11.3	98.0±13.5	159 ± 12.9	17.7±2.38	26.4±12.5	54.7±7.97	104±18.9

*correlation with t_f at $P < 0.05$ or better. Seeds were from randomly chosen. t_g , time taken for 50% germination, t_f , time taken for 50% flowering, t_{la} represents time taken for appearance of the i th leaf, t_{lg} represents time taken for 50% growth of the i th leaf, ‘ b ’ refers to steepness related parameter of the logistic function and y_{max} represents asymptote growth it can obtain for the i th leaf as specified. Analysis of slope for trends among seedlings by reduced major axis (RMA) within each variety (i.e., intra-varietal) which are significant: Tulasi $t_{lg3}(h) = (0.98 \times t_{la3}) + 5.25$, $r = 0.79$, $P < 0.001$, $n = 31$; Vikas ($\sim r \geq 0.35$ for $n \geq 33$), $t_{la3}(h) = (1.25 \times t_{lg2}) + 25.9$, $r = 0.73$, $P < 0.001$, $n = 32$; $t_{lg3}(h) = (1.47 \times t_{lg2}) + 14.3$, $r = 0.64$, $P < 0.001$, $n = 33$; $t_{lg3}(h) = (1 \times t_{la3}) + 11.0$, $r = 0.84$, $P < 0.001$, $n = 32$; Salivahana ($\sim r \geq 0.35$ for $n \geq 30$); $t_{la3}(h) = (0.93 \times t_{lg2}) + 68.1$, $r = 0.43$, $P < 0.02$, $n = 29$; $t_{lg3}(h) = (1.05 \times t_{lg2}) + 56.7$, $r = 0.83$, $P < 0.001$, $n = 29$; $t_{lg3}(h) = (1.14 \times t_{la3}) - 20.7$, $r = 0.71$, $P < 0.001$, $n = 29$ (only time based growth measurements included here for brevity). J_0 computed as $1 \mu\text{L} = 44.64$ nmoles.

respiration. One important variable is the partial pressure of oxygen, modified simply with the application of a vacuum pump or with a balloon, filled with either air or pure oxygen to the mouth of the flask/bottle.

1. Effect of pressure: In an elevated oxygen atmosphere, germination, t_g , decreased from (42.2 ± 1.9) h (normal air and pressure) to (38.1 ± 2.75) h (≥ 25 times the normal partial pressure of oxygen at 20 mm Hg greater pressure) ($P < 0.02$ by Student's 't' test). Germination in seeds was not significantly inhibited by lowering the air pressure from the ambient by 70 mm Hg ($t_g = (42.8 \pm 1.6)$ h) (Fig. 8). The seed varieties ($n = 6$) used were selected for the largest variation in t_f . The effect of higher pressure on germination was consistent with diffusion limitation to the growing embryo (Fig. 5, *vide supra*). The small range of effects did not favour detailed growth studies in rice.

2. Effect of temperature: Temperature enhances respiration and represents a major environmental

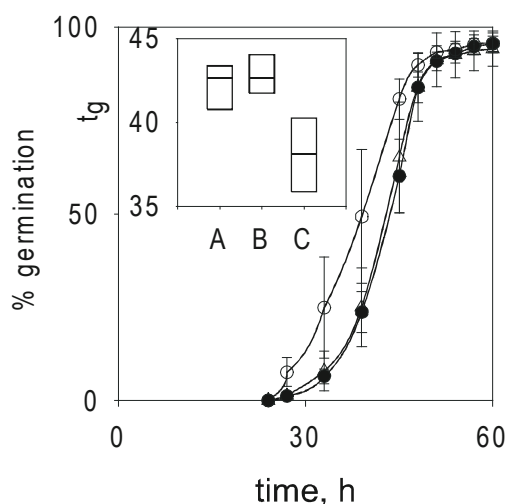

Fig. 8. Effect of variable air pressure on germination. The seeds (variety Aditya ($t_f = 90$ d), Tulasi ($t_f = 100$ d), Vikas ($t_f = 120$ d), Ajaya ($t_f = 130$ d), Mandyavijay ($t_f = 140$ d) and Salivahana ($t_f = 150$ d)) were grown in Arnon-Hoagland's medium, pH 5.6, control (A) seedlings were kept open to atmosphere, (B) under low pressure (obtained with a vacuum pump, (69-71) mm Hg less than control) and the partial pressure of oxygen was enhanced ~ 25 times (C) the normal partial pressure of oxygen, at ~ 20 mm Hg greater pressure, with a balloon filled with pure oxygen attached to the mouth of the glass bottle in which the seeds/seedlings were germinated as described in text. A and B, indistinguishable, dark circle and C, open circle. Vertical line indicate ± 1 S.D.

variable of interest. The seeds (variety Tulasi, $n=35$ each) were (obtained from a single set of the mode of the weight distribution) some grown at $(19.5-20)^\circ\text{C}$ and another aliquot at $(30-30.5)^\circ\text{C}$ and at 100 % humidity. The growth dynamics were 2-3 fold slower at the lower temperature with increase in time for life stages and lowered growth both in terms of time constants ($t_{lg(i)}$, $t_{la(i)}$) and rate related parameters b_i , also in terms of the final asymptotic growth achieved in the leaves $y_{\max(i)}$ of seedlings in Tulasi at $P \ll 10^{-4}$ (Fig 9). Thus, in the determinate phase of vegetative growth, the growth processes behaved as a simple cascade when varied the growth conditions, as seen in the corresponding correlation matrices (Tables 4,5). Time-based measurements of life stages again showed good correlations within each set grown at the same temperature.

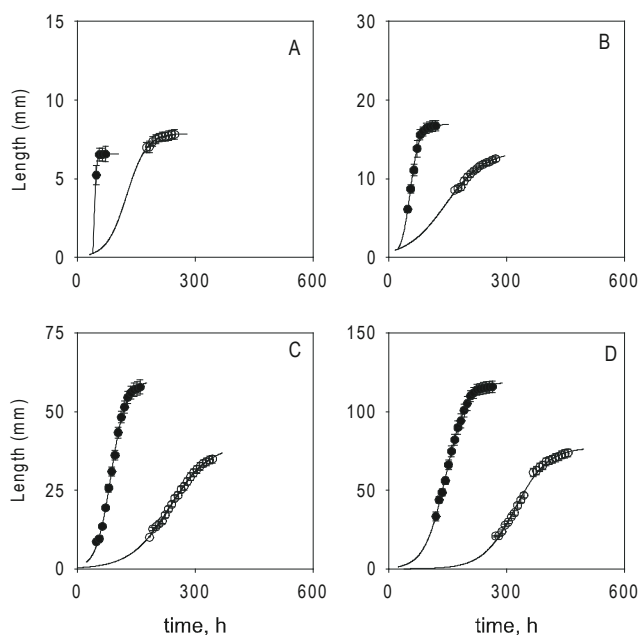

Fig. 9. Growth of rice seedlings (shoot) at 20 & 29 °C. The rice seedlings growth grown in $(29-29.5)^\circ\text{C}$ (filled circle, $n=35$) and $(20-20.5)^\circ\text{C}$ (unfilled circle, $n=35$) under constant fluorescent lamp light ($15 \mu\text{mol}\cdot\text{s}^{-1}\cdot\text{m}^{-2}$) in a desiccator for keeping at 100% humidity. The seeds were grown in Arnon-Hoagland's medium at pH=5.6. Growth of third leaf length was measured at 8 h. intervals and plotted as average length (vertical bars represent S.E.M.). The length of the each part was fitted to logistic equation. The symbols represent the experimental data and lines represent theoretical data by fitting in to logistic equation. A. Growth of coleoptile, B. first leaf, C. second leaf, D. third leaf length. Seeds selected from mode distribution (M-design).

Table 4. Complete correlation matrix between various growth characteristics of rice seedling grown at 30°C.

	t_{la1}	t_{la2}	t_{la3}	t_{lg1}	t_{lg2}	t_{lg3}	b_1	b_2	b_3	y_{max1}	y_{max2}
t_{la2}	0.719										
t_{la3}	0.06	0.227									
t_{lg1}	0.661	0.659	0.169								
t_{lg2}	0.607	0.705	0.423	0.655							
t_{lg3}	0.127	0.248	0.625	0.281	0.607						
b_1	-0.165	0.037	0.244	-0.253	0.214	0.249					
b_2	-0.008	0.054	0.416	-0.17	0.43	0.312	0.407				
b_3	0.049	0.117	0.101	0.183	0.163	0.617	0.123	-0.202			
y_{max1}	-0.328	-0.17	0.119	0.073	0.17	0.253	0.16	0.137	0.165		
y_{max2}	-0.196	-0.023	0.146	0.21	0.367	0.367	0.175	0.153	0.299	0.912	
y_{max3}	-0.107	0.043	0.354	0.216	0.301	0.668	0.052	0.071	0.547	0.424	0.548

Correlation matrix of various growth characteristics of rice seedling at 30°C. Correlations better than 0.05 represented by bold numbers ($r \geq 0.35$ for $n \geq 30$). t_{la} represents time taken for appearance of leaf (t_{la1} , t_{la2} and t_{la3} represents the first leaf, second leaf and third leaf appearances) and t_{lg} represents time taken for 50% growth of the leaf (t_{lg1} , t_{lg2} and t_{lg3} represent the first leaf, second leaf and third leaf 50% growth). b , is the steepness related parameter of the logistic function, and y_{max} represents the asymptote of growth (length) in each leaf. Variety Tulasi. Seeds were mode distribution. Bold numbers indicate $P < 0.05$. $t_{la2}=(1.22 \times t_{la1})-1.41$, $r=0.72$, $n=34$, $P<0.001$; $t_{la3}=(0.904 \times t_{la1})+8.93$, $r=0.66$, $n=34$, $P<0.001$; $t_{lg2}=(1.13 \times t_{la1})+26.9$, $r=0.61$, $n=34$, $P<0.001$; $t_{lg1}=(1.35 \times t_{la2})-13.5$, $r=0.66$, $n=34$, $P<0.001$; $t_{lg2}=(0.924 \times t_{la2})+28.2$, $r=0.71$, $n=34$, $P<0.001$; $t_{lg2}=(1.24 \times t_{la3})+26.3$, $r=0.423$, $n=31$, $P<0.02$; $t_{lg3}=(1.45 \times t_{la3})-48.6$, $r=0.62$, $n=31$, $P<0.0002$; $b_2=(5.21 \times t_{la3})+42.15$, $r=0.416$, $n=31$, $P<0.02$; $y_{max3}=(2.57 \times t_{la3})-223$, $r=0.35$, $n=31$, $P<0.05$; $t_{lg2}=(1.25 \times t_{lg1})+15.8$, $r=0.65$, $n=34$, $P<0.001$; $t_{lg3}=(1.79 \times t_{lg2})-10.5$, $r=0.61$, $n=31$, $P<0.0003$; $b_2=(0.262 \times t_{lg2})-5.05$, $r=0.43$, $n=34$, $P<0.01$; $y_{max2}=(1.48 \times t_{lg2})-68.1$, $r=0.37$, $n=34$, $P<0.03$; $b_3=(0.387 \times t_{lg3})-32.4$, $r=0.62$, $n=31$, $P<0.0002$; $y_{max2}=(1.48 \times t_{lg3})-68.1$, $r=0.38$, $n=34$, $P<0.03$; $y_{max3}=(1.77 \times t_{lg3})-137$, $r=0.67$, $n=31$, $P<0.01$; $b_2=(1.42 \times b_1)+4.3$, $r=0.41$, $n=33$, $P<0.02$; $y_{max3}=(4.58 \times b_3)+11.1$, $r=0.55$, $n=31$, $P<0.001$; $y_{max2}=(4.28 \times y_{max1})-12.6$, $r=0.91$, $n=34$, $P<0.001$; $y_{max3}=(8.8 \times y_{max1})-31$, $r=0.42$, $n=31$, $P<0.0176$; $y_{max3}=(2.08 \times y_{max3})-6.47$, $r=0.55$, $n=31$, $P<0.001$.

3. Energy partitioning: The end effect of respiration lies in the energy available for growth. We examined whether energy partitioning limits growth of each part or whether each part is entirely autonomous. Excision of each leaf before it achieved $t_{lg(i)}$ did not significantly affect the dynamics of either the preceding or the subsequent leaf when tested in the growth phase between the leaves, 2-4. For example, while $t_{lg(3)}$ was (163 ± 30.1) h, excision of 2nd leaf yielded $t_{lg(3)}$ (162 ± 22.5) h, nearly identical, i.e., the influence on life stages was minimal (Fig. 10A). Is the determinate nature of their growth really independent of possible energy partitioning between leaves? In this variety Tulasi, ($n=30$ each, seeds from the mode of the distribution i.e., (21.6 ± 0.27) mg), when the mean values of leaf length were plotted at each time interval of 24 h, the difference significantly increased with time and

saturated ($P < 0.001$ for a quadratic fit) indicating a small yet finite influence on leaf length (therefore mass) consistent with energy partitioning (Fig. 10B) (cf. Appendix I). This effect was not seen in randomly selected seeds (21.7 ± 1.97) mg (data not given, cf. Jacobs and Bullwinkel, 1953; Jacobs and Suthers, 1974). Thus the life stages, unlike biomass *per se*, appear to be less susceptible to energy partitioning inherent to environment-induced variation.

DISCUSSION

Appendix I gives a formal model for energy partitioning, whose relevance required some effort in the experimental design and analysis to demonstrate its small but significant relevance. Such a model has the additional advantage of permitting an evaluation of variance in a

Table 5. Complete correlation matrix between various growth characteristics of rice seedlings grown at 20°C.

	t_{ia1}	t_{ia2}	t_{ia3}	t_{ia4}	t_{ig1}	t_{ig2}	t_{ig3}	t_{ig4}	b_1	b_2	b_3	b_4	Y_{max1}	Y_{max2}	Y_{max3}	
t_{ia2}	0.531															
t_{ia3}	0.14	0.684														
t_{ia4}	0.379	0.33	0.44													
t_{ig1}	0.301	0.056	0.45	0.048												
t_{ig2}	0.374	0.679	0.638	0.263	0.07											
t_{ig3}	0.42	0.605	0.622	0.589	0.214	0.568										
t_{ig4}	0.01	0.053	0.38	0.099	0.721	0.066	0.268									
b_1	0.341	0.036	0.22	0.075	0.874	-0.104	0.006	0.67								
b_2	0.095	-0.128	-0.398	0.232	-0.169	0.33	0.189	-0.011	-0.022							
b_3	0.149	-0.268	-0.082	0.35	0.098	-0.166	0.206	0.238	-0.015	0.17						
b_4	-0.126	-0.174	0.109	-0.12	0.445	-0.012	-0.084	0.714	0.472	0.067	0.365					
Y_{max1}	0.331	0.033	0.36	0.075	0.96	0.02	0.134	0.74	0.963	-0.054	0.064	0.47				
Y_{max2}	0.198	-0.164	0.003	0.328	-0.11	0.67	0.239	0.139	-0.057	0.77	0.205	0.142	0.001			
Y_{max3}	0.374	-0.105	0.061	0.016	0.176	-0.057	0.476	0.252	0.192	0.082	0.207	0.177	0.243	0.72		
Y_{max4}	-0.072	-0.074	0.144	-0.36	0.62	-0.079	0.032	0.84	0.697	0.006	-0.114	0.68	0.684	0.046	0.418	

Correlation matrix of various growth characteristics of rice seedling at 20°C. Correlations better than 0.05 represented by bold numbers ($\sim r \geq 0.35$ for $n \geq 30$). t_{ia} represents time taken for appearance of leaf (t_{ia1} , t_{ia2} and t_{ia3} represents the first leaf, second leaf and third leaf appearances) and t_{ig} represents time taken for 50% growth of the leaf (t_{ig1} , t_{ig2} and t_{ig3} represents the first leaf, second leaf and third leaf 50% growth). b , is the steepness related parameter of the logistic function, and Y_{max} represents the asymptote of growth (length) in each leaf. Variety Tulasi. Seeds were mode distribution. t_{ia} represents time taken for appearance of leaf and t_{ig} represents time taken for 50% growth of the leaf. Seeds were from mode distribution. Analysis of slope for trends by reduced major axis (RMA); Bold numbers indicate $P < 0.05$. $t_{ia2} = (1.29 \times t_{ia1}) - 33.8$, $r = 0.56$, $P < 0.01$, $n = 27$. $t_{ig3} = (1.47 \times t_{ia2}) + 45.2$, $r = 0.42$, $P < 0.05$, $n = 25$. $t_{ia3} = (0.09 \times t_{ig1}) + 277$, $r = 0.45$, $P < 0.05$, $n = 24$. $t_{ig4} = (0.27 \times t_{ig1}) + 363$, $r = 0.65$, $P < 0.01$, $n = 21$. $t_{ig2} = (0.99 \times t_{ia2}) + 23.8$, $r = 0.67$, $P < 0.001$, $n = 31$. $t_{ia3} = (1.33 \times t_{ia2}) + 20.9$, $r = 0.68$, $P < 0.001$, $n = 28$. $t_{ig3} = (0.68 \times t_{ia2}) + 177$, $r = 0.59$, $P < 0.01$, $n = 27$. $t_{ia3} = (1.39 \times t_{ig2}) - 27.8$, $r = 0.64$, $P < 0.001$, $n = 28$. $t_{ig3} = (0.64 \times t_{ig2}) + 168$, $r = 0.57$, $P < 0.01$, $n = 27$. $t_{ig3} = (1.00 \times t_{ia3}) + 23.5$, $r = 0.63$, $P < 0.001$, $n = 27$. $t_{ia4} = (0.96 \times t_{ia3}) + 122$, $r = 0.44$, $P < 0.02$, $n = 22$. $t_{ia4} = (1.24 \times t_{ig3}) + 9.36$, $r = 0.59$, $P < 0.01$, $n = 22$. $t_{ig3} = (0.89 \times t_{ig2}) + 111$, $r = 0.52$, $P < 0.009$, $n = 24$. $t_{ig1} = (0.48 \times b_1) - 29.7$, $r = 0.87$, $P < 0.001$, $n = 26$. $t_{ig1} = (0.141 \times b_4) + 21.4$, $r = 0.44$, $P < 0.04$, $n = 21$. $t_{ig1} = (0.099 \times Y_{max1}) - 1.5$, $r = 0.96$, $P < 0.001$, $n = 26$. $t_{ig1} = (0.256 \times Y_{max4}) + 40.9$, $r = 0.62$, $P < 0.003$, $n = 21$. $t_{ig2} = (0.607 \times Y_{max2}) - 102$, $r = 0.67$, $P < 0.0002$, $n = 26$. $t_{ig3} = (1.08 \times Y_{max3}) - 272$, $r = 0.48$, $P < 0.01$, $n = 27$. $b_1 = (0.558 \times t_{ig4}) + 380$, $r = 0.67$, $P < 0.0009$, $n = 21$. $t_{ig4} = (0.518 \times b_4) - 166$, $r = 0.71$, $P < 0.0002$, $n = 22$. $t_{ig4} = (0.964 \times Y_{max4}) - 310$, $r = 0.84$, $P < 0.001$, $n = 22$. $b_1 = (0.294 \times b_4) + 30.4$, $r = 0.47$, $P < 0.03$, $n = 21$. $b_1 = (0.208 \times Y_{max1}) + 4.67$, $r = 0.96$, $n = 0.001$, $n = 26$. $b_2 = (1.05 \times Y_{max2}) - 3.36$, $r = 0.77$, $P < 0.001$, $n = 26$. $Y_{max1} = (1.38 \times b_4) + 24.1$, $r = 0.47$, $P < 0.03$, $n = 21$. $b_4 = (1.86 \times Y_{max4}) - 1.302$, $r = 0.68$, $P < 0.0005$, $n = 22$. $Y_{max1} = (2.49 \times Y_{max4}) + 45.8$, $r = 0.68$, $P < 0.0006$, $n = 21$. $Y_{max2} = (2.1 \times Y_{max3}) - 7.07$, $r = 0.72$, $P < 0.0001$, $n = 24$.

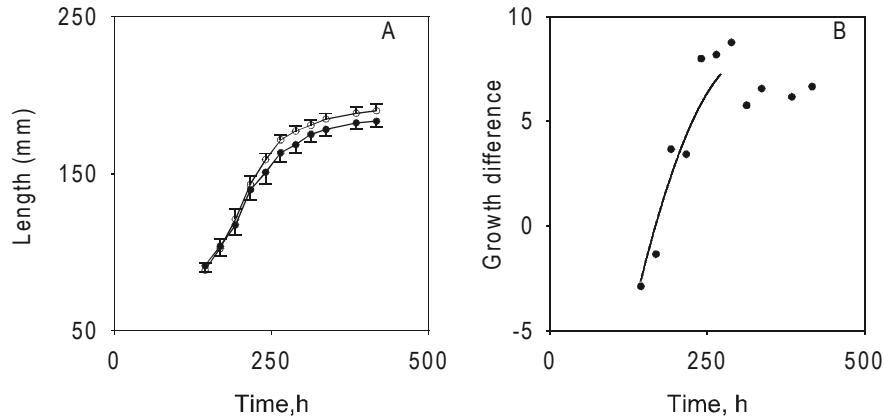

Fig. 10. Effect of excision of 2nd leaf on the growth dynamics of third leaf. Seeds from mode distribution. The rice seedlings growth grown in (29-29.5)°C under constant fluorescent lamp light (15 $\mu\text{mol}\cdot\text{s}^{-1}\cdot\text{m}^{-2}$) in a desiccator for keeping at 100% humidity. The seeds were grown in Arnon-Hoagland's medium at pH=5.6. A. Growth in length of 3rd leaf was measured at 8 h. intervals and plotted as average length (vertical bars represent S.E.M.) in control plants (n=35), filled circle, and in plants which the second leaf of the plant were cut as soon as it emerges and the length of the third leaf was monitored (unfilled circle) (n=35). The logistic equation (Eq.3) yielded for control plant, $\text{length} = 187 / (1 + e^{-(\text{time}-152)/62.2})$, n=11, r=0.997, P<0.001, the second leaf excised plant, $192 / (1 + e^{-(\text{time}-157)/54.8})$, n=11, r=0.998, P<0.001. B. Absolute difference in the growth between second and third leaf length. This was fitted to $y = -27.03 + (0.218 \cdot x) + (-0.0003 \cdot x^2)$ r=0.92, n=11, P<0.001.

number of time and size related parameters as well as rate processes, compared to the rather simpler, though otherwise adequate, logistic model.

Influence of sampling design on the coefficient of variation of different physiological variables

Fig 11 gives an evaluation of the coefficient of variation

among various physiological parameters assessed in an M-design and a U-design. The uniform distribution led to enhanced variation. Also the time measurements (t_{lai} and t_{lgi}) showed much less coefficient of variation than the rate measurements (a, b) and mass measurements (y_o , y_c and y_{max} , all as defined in Appendix I). The influence of U-design was on the magnitude of variation and not on the relative merit of various measurements.

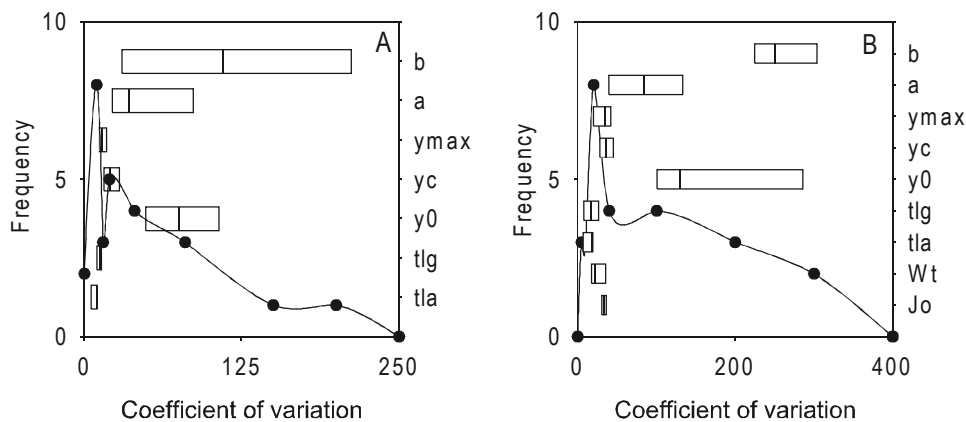

Fig. 11. Frequency distribution of coefficient of variation (%) of growth parameters of Tulasi (A, M-design) and Vikas (B, U-design) seeds, based on the model described in Appendix I. The growth parameter was obtained by fitting the length of the growing shoots in to the energy partitioning model. t_{la} represents time taken for appearance of leaf, t_{lg} represents time taken for 50% growth of the leaf, b and a rate of growth (growth/time), y_{max} maximum value of the growth attribute a plant can achieve (length). y_o lower asymptote value, y_c , 50% growth of the leaf at 50% time. J_o , respiration (nmoles of oxygen consumed. seed^{-1}). Coefficient of variation was calculated for Tulasi n \leq 30, for Viaks n \leq 45. The box plot shows the median and 10th and 90th percentile of the coefficient of variation of each variable indicated on the right axis.

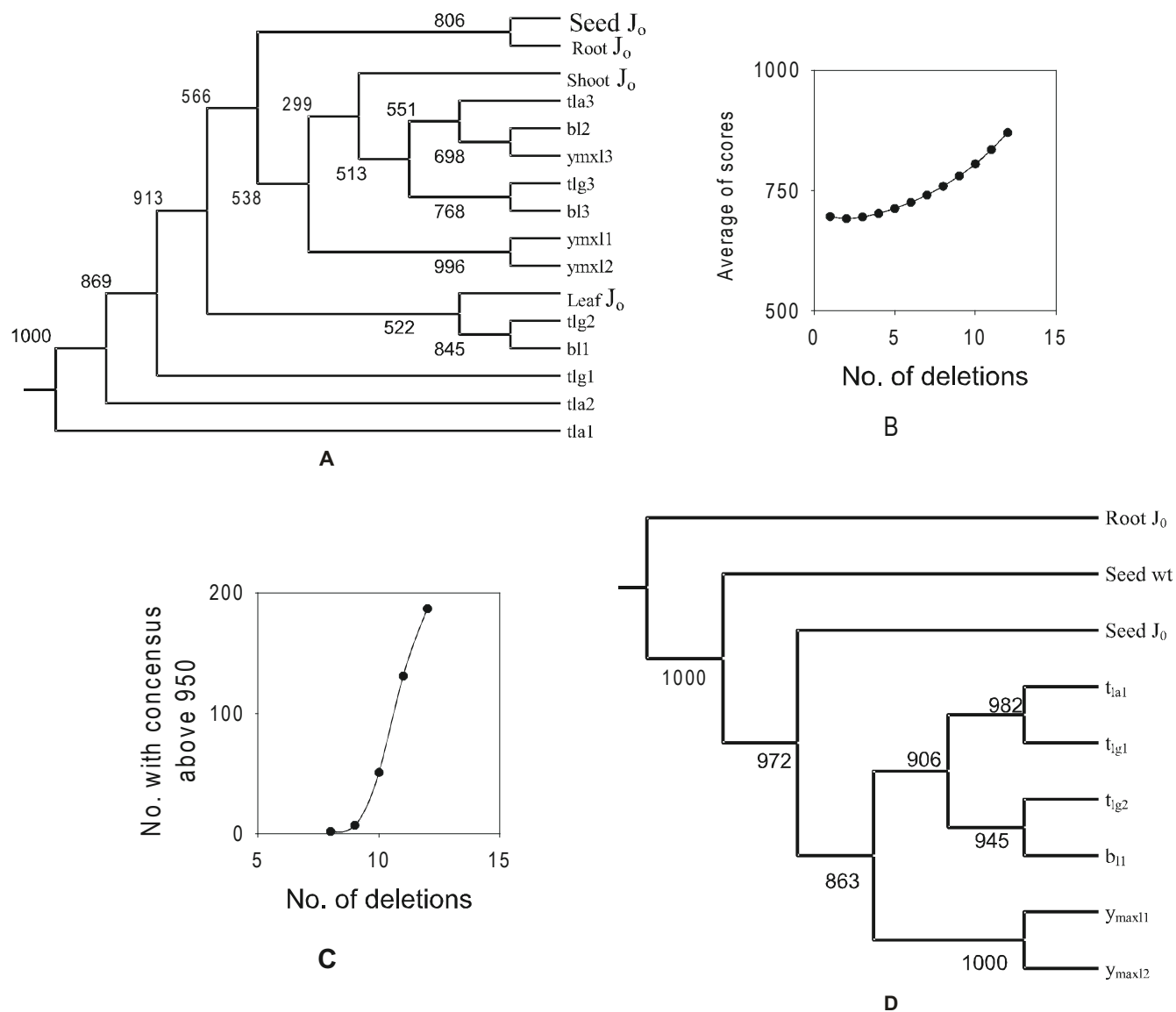

Fig. 12. Dendrogram analysis. A dendrogram (Felsenstein, 1989) was constructed for the phenological variables: seed respiration expressed as nmoles of oxygen consumed.min⁻¹.seed⁻¹ (J_o /seed); t_{ia} represents time taken for appearance of leaf (t_{ia1} and t_{ia2} represent the first leaf and second leaf appearances) and t_{ig} represents time taken for 50% growth of the leaf (t_{ig1} and t_{ig2} represent the first leaf and second leaf 50% growth). 'b' refers to steepness related parameter of the logistic function and y_{max} refers to the asymptote of growth (length) in each leaf. Totally 17 parameters were used for the analysis. Number of consensus trees observed above 95% (Milner *et al.*, 2003). From '(1-r²)*100' values, the jackknife estimates of errors were computed (r1). Totally 17 parameters were used for the analysis. J_o /seed was kept constant and remaining parameters were deleted in all (1 to 12) unique possible combinations. For each combination of deletion 1000 pseudorandom matrices were created and a consensus tree (rooted) was constructed using PHYLIP (Felsenstein, 2004). For each consensus tree average of occurrence of internal node was computed. Fig B, fraction of parameters vs. number of consensus tree appeared above 95% were plotted. Fig C, from the computed averages of consensus tree group at each combination of deletions mean from the group was plotted as the function of number deletion. D. dendrogram was constructed after jackknife estimate. Number of consensus trees observed above 95%. From '(1-r²)*100' values, the jackknife estimates of errors were computed. J_o /seed was kept constant and remaining parameters were deleted in all unique possible combinations. For each combination of deletion 1000 pseudorandom matrices were created and a consensus tree was constructed using PHYLIP. For each consensus tree average of occurrence of internal node was computed. The dendrogram was visualized by an application TREEVIEW (Page, 1996).

In fact, time-based measurements were more robust than mass and rate measurements, regardless of the design (comparable analyses of the data with logistic and Richard functions omitted for brevity). Interestingly, the seed-related variables, weight and rate of respiration exhibit low variance comparable to time based measurements.

How related are the physiological variables?

In a cascade of physiological processes, each step contributes to variance while the processes themselves show interrelationships reflected in the coefficient of correlation. Thus the nature of the cascade (determinant relationships) is obscured to the degree that the correlation suffers and renders the cascade indeterminate. The ontogenic (process) relationships are comparable to phylogenetic or evolutionary relationships as both capture time and distance and best seen by representing the closeness of parametric relationships as a dendrogram (Felsenstein, 1989) as in evolutionary studies, except that $((1-r)^2)$ is used as a measure of distance between the phenological traits. Since the uncertainty associated with the coefficients of correlation leads to several possible alternatives for a specific tree, the best fit for given interrelationships

can be assessed by constructing a consensus tree for such a correlation matrix (cf. Milner *et al.*, 2003). It is reasonable that the net consensus using bootstrapping procedures favours a value better than 0.95. Since much of plant growth is determinate, some variables would be more related than others in a given situation. Less related variables would tend to lower the consensus below 95% (Fig 12A). In order to arrive at 95 % or higher consensus, one examines the results by eliminating all variables one by one, followed by two and even three or more at time (Fig 12B) to arrive at the minimum measured variables to be eliminated iteratively to obtain the required net consensus (Fig 12C). It stands to reason that these would be the physiological variables that are of prime relevance (Fig 12D), as shown with a rooted tree. This approach is significantly different in phenotype determination than pursuit of mere correlations, for which definitive limitations exist due to irreducible variation in plants however good are the samples and their handling. Regardless of the methods used, molecular or physiological, there are no alternatives to this strategy to examine a quantitative trait such as yield.

Clearly, time related events are the best estimators of the phenotype in all the phenological measurements.

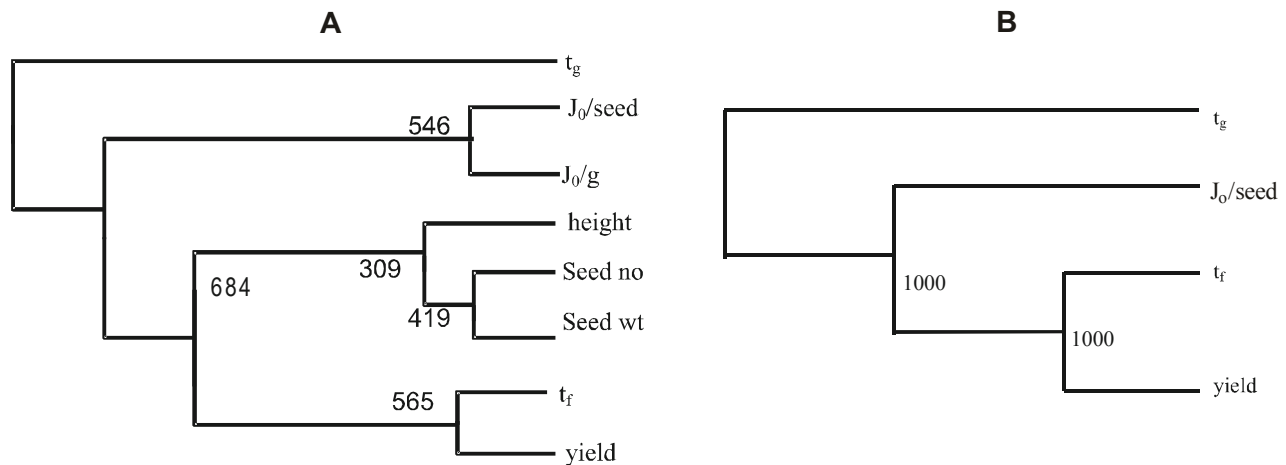

Fig. 13. Analysis of phenological correlations. A. A dendrogram was constructed for the phenological variables using the regression values as described in Fig. 12. Seed respiration expressed as nmoles of oxygen consumed. $\text{min}^{-1}.\text{seed}^{-1}$ (J_0/seed) as well as nmoles of oxygen consumed. $\text{min}^{-1}.\text{g}^{-1}$ (J_0/g); t_g , time (h) taken for 50% germination; t_f , time (d) taken for 50% flowering and yield, expressed in tonnes.hectare $^{-1}$, plant height (cm) and seed weight obtained on weighing ~ 1 gm seeds divided by no. of seeds. B. From $(1-r^2)\times 100$ values, the jackknife estimates of errors were computed. The dendrogram was constructed based on $(1-r^2)\times 100$ values using the program NEIGHBOR (PHYLIP) (Felsenstein, 2004). The dendrogram was visualized by an application TREEVIEW (Page, 1996). Bootstrapping was performed to estimate the confidence on the dendrograms. Initially 1000 pseudorandom matrices (samples) were constructed and dendrogram was constructed by NEIGHBOR. A consensus tree (unrooted) was constructed by the program CONSENSUS (PHYLIP) (Milner, 2003), which exhibited absolute consensus of 1000 with only four variables for seed respiration/germination and for flowering/yield, as shown.

The dendrogram analysis was also carried out on the data on 24 varieties of rice (Table 1). Fig 13A gives the dendrogram using all measured variables with poor resolution. The iterative approach defined here (cf. Fig. 12) permitted omission of seed number, seed weight and plant height, the mass related variables and even respiration expressed per gram seed weight as less relevant and the resulting dendrogram achieved 100% consensus (Fig. 13B)! A rooted or an unrooted tree yielded the same information, the latter preferred since the interest was in the inherent relationships without bias and not in phylogenetic relationships.

The role of budding and branching

The critical feature that emerges in these studies is that the two widely separated meristematic events, largely reflecting cell division, in the growth of an annual (or weakly perennial), i.e., the determinate (vegetative) t_g

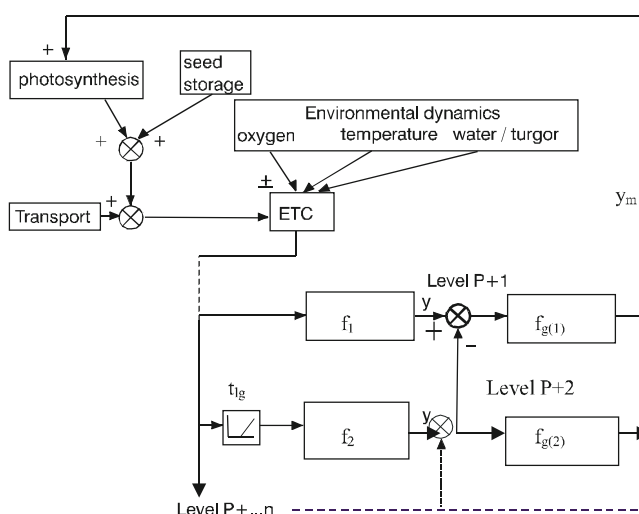

Fig. 14. Respiration as a determinant of plant growth. The overall inputs into plant growth (y_m) are photosynthesis, transport via roots, besides a variable environment, which input ultimately utilizable carbon into the electron transport chain (ETC) of mitochondria. These inputs are mass specific, increasing with the increasing mass of the plant. The plant is made of p levels /parts/branches, the figure representing level $p+1$ and $p+2$. The energy input from ETC leads to growth of meristematic cells defined by an appropriate function f_i with an output, y , which is a measure of energy available for growth of the part, in turn defined by a function f_g for that part. After a finite threshold in time, t_c , growth at level $P+2$ takes off competing for the output y . This leads to cessation of growth of $p+1$. Removal of $p+1$ by excision should affect the partitioning of energy to $p+2$ and vice versa.

and subsequent (reproductive) t_r , both of which are time based measurements, correlate with respiration and even the intervening life stages of leaves, which involve division, differentiation, structure formation and elongation, are also related to seed respiration. There does not appear to be any reason to limit the applicability of the results to rice alone. How does respiration hasten maturation? Cell division is known to be under direct control of the redox state (respiration) of the cell (Gillete and Sejnowski, 2005; Rothstein and Lucchesi, 2005). Faster cell division would require structural/spatial readjustment within the compact meristematic layer of cells. The obvious solution is budding simply based on the inherited pattern (Meyerowitz, 1997; Cho, 2004; Newell and Shipman, 2005). This would lead to completion of the determinate growth (life stages) faster, presaging faster maturation of the plant. It can be shown simply that if D_1 is the internodal length and B_1 is the branch length, for N cells, the volume occupancy in a cube

$$V_o \propto (D_1 + B_1)^3 / (N^2 \cdot D_1^3) \quad \dots\dots (6)$$

Thus an increase in the internodal distance (elongation mediated by the vacuole and not just branching by division alone) would enhance the lacunarity of the three-dimensional structure. Thus a fast breathing plant with faster branching and completes life stages faster with less time for elongation would result in a smaller, more compact, plant with smaller canopy and lower yield. A slow growing plant, on the other hand, captures the larger canopy (area) by high lacunarity and gives better yield. Clearly respiration controls the dynamics of the ontogeny of a plant and thereby contributes to heterochrony relevant to plant evolution (cf. Klingenberg, 1998). While allometry emphasizes mass (Niklas and Enquist, 2001), a more relevant variable for size in plants perhaps relates to the volume/density (Franco and Kelly, 1998). In uncontrolled three-dimensional growth, lacunarity does not exist, unlike in fractal growth patterns. The role of respiration in controlling the size of a plant, not the other way around as conventionally argued in allometry (Reiss, 1989), is consistent with the observations on the enhanced yield in crop plants due to total leaf area/biomass (Shipley and Vu T-T, 2002) and not photosynthetic efficiency per unit leaf area (Richards, 2000). The replacement of volume (which incorporates the lacunarity) with mass and, respiration as the basis of differential growth dynamics rather than the result of growth, have important consequences in understanding allometric behaviour of plants.

Since specific mutations can change and even vitiate these relationships by focal or pleiotypic interactions, we restrict the discussion to normal growth of plants. In a variable environment, availability of water and other environmental conditions being uncertain, a potential for variation in life span that allows a better match for the seasonal variations in environment would be important for the survival and propagation of the species. The vacuole, the means for elongation in plant cells, offers the basis of larger yield by providing for higher lacunarity, to an extent that photosynthesis is hardly limiting for plant growth, thereby its benefit exceeding far out of proportion to costs (Raven, 1997). Breeding strategies for higher yield should focus on selection of parents based on these ecological and developmental principles. Phenotypic variation in respiration/ t_f (competently measured simply by using t_g), offers exactly that, besides contributing to dynamics that serve as a biological clock. Yield is a trade-off derived from the life span, an ecological strategem so important that it can be seen clearly even in commercial varieties, which would be biased towards higher yield as opposed to sampling at the level of germplasm. The key controlling factor itself would remain the generation time, in parts (as with germination etc.,) and for the whole plant (as with flowering), directly modulated by a single physiological factor, respiration, thereby help define where to look for quantitative trait loci for yield. These studies reveal the possibility that the allometric relationship, size determining the metabolic rate, is reversed such that respiration determines the size and the relevant theoretical implications will be communicated elsewhere.

ACKNOWLEDGEMENTS

The authors thank Drs. V. Arunachalam, S. Bhargava, H. Bhate, N.V. Joshi, S.P. Modak and M. Udayakumar and M. Milner for discussions, the Directorate of Rice Research, Hyderabad for rice seeds and phenological data, and, University Grants Commission, Department of Science and Technology and Department of Biotechnology, India and Indian Space Research Organization for research support and fellowships. Prof. N.V. Joshi kindly provided the programme for energy partitioning model in the appendix.

REFERENCES

Abe M, Kobayashi Y, Yamamoto S, Daimon Y, Yamaguchi A, Ikeda Y, Ichinoki H, Notaguchi M, Goto K, Araki T.

- (2005). FD, a bZIP protein mediating signals from the floral pathway integrator FT at the shoot apex. *Science*, 309:1052-1056.
- Cannell M.G.R., Thornley J.H.M. (2000). Modelling components of plant respiration: some guising principles. *Annals of Botany*, 85: 45-54.
- Causton D.R., Venus J.C. (1981). *The Biometry Of Plant Growth*: Edward Arnold, London.
- Cho A. (2004). Life's Patterns: No Need to Spell It Out? *Science*, 303: 782-783.
- Falster D.S. (2003). <http://www.bio.mq.edu.au/ecology/SMATR/>.
- Felsenstein J. (1989). PHYLIP - Phylogeny Inference Package (Version 3.2). *Cladistics*, 5: 164-166.
- Felsenstein J. (2004). PHYLIP - Phylogeny Inference Package (version 3.6). Distributed by the author. Department of Genome Sciences, University of Washington, Seattle.
- Franco M, Kelly C.K. (1998). The inter-specific mass-density relationship and plant geometry. *Proc. Natl. Acad. Sci., (USA)*, 95: 7830-7835.
- Glass Å, Karopka T, Wolkenhauer O. (2006). Bioinformatics and The Virtual Cell (Bioinformatik und die Virtuelle Zelle). *InformationTechnology*, 48: 44-51.
- Gillete M.U., Sejnowski T.J. (2005). Biological clocks coordinately keep life on time. *Science*, 309: 1196-1198.
- Hoagland D, Arnon D. (1950). The water-culture method for growing plants without soil. *California Agricultural Experiment Station Circular* 347.
- Jacobs W.P., Bullwinkel B. (1953). Compensatory growth in coleus shoots. *American Journal of Botany*, 40: 385-392.
- Jacobs W.P, Suthers H.B, (1974). Effect of leaf excision on flowering of Xanthium apical buds in culture under inductive and noninductive photoperiods. *American Journal of Botany*, 61: 1016-1020.
- Klingenberg C.P. (1998). Heterochrony and allometry: the analysis of evolutionary change in ontogeny. *Biological Reviews*, 79: 79-123.
- Mathai J.C, Sauna Z.E, John O, Sitaramam V. (1993). Rate limiting step in electron transport: osmotically sensitive diffusion of quinones through voids in the bilayer. *Journal of Biological Chemistry*, 268: 15442-15454.
- Meyerowitz EM. 1997. Genetic Control of Cell Division Patterns in Developing Plants. *Cell* 88, 299-308.
- Milner M, Patwardhan V, Bansode A, Nevagi S.A, Kulkarni S, Kamakaka R, Modak S.P. (2003). Constructing 3-D phylogenetic trees. *Current Science*, 85:1471-1478.
- Newell A.C, Shipman P.D. (2005). Plants and Fibonacci. *Journal of Statistical Physics*, 121: 937-968.
- Niklas K.J, Enquist B.J. (2001). Invariant scaling relationships for interspecific biomass production rates and body size. *Proc. Natl. Acad. Sci., (USA)*, 98: 2922-2927.
- Nishimura A, Ashikari M, Lin S, Takashi T, Angeles ER, Yamamoto T, Matsuoka M. (2005). Isolation of a rice regeneration quantitative trait loci gene and its application to transformation systems. *Proc. Natl. Acad. Sci., (USA)*, 102: 11940-11944.

- Okubo H. (2000). Growth Cycle and Dormancy in Plants. Editors: Viemont J.D., Crabbé J., CABI Publishing, U.K. pp.1-22.
- Page R.D.M. (1996). TREEVIEW: An application to display phylogenetic trees on personal computers. *Computer Applications in the BioSciences*, 12: 357-358.
- Raven J.A. (1997). The Vacuole: Cost-benefit analysis. In: The Plant Vacuole, Editors: Leight R.A, Sanders D., Academic Press, New York. pp.59-82.
- Reiss MJ. (1989). The allometry of growth and reproduction: Cambridge University Press, Cambridge.
- Richards RA. 2000. Selectable traits to increase crop photosynthesis and yield of grain crops. *Journal of Experimental Botany*, 51: 447-458.
- Rosato A, Strandburg K.J, Prinz F, Swendsen R.H. (1987). Why the Brazil nuts are on top: size segregation of particulate matter by shaking. *Physical Review Letters*, 58: 1038-1040.
- Rothstein E.C, Lucchesi P.A. (2005). Redox control of the cell cycle: a radical encounter. *Antioxidants & redox signaling*, 7: 701-703.
- Shipley B, Vu T-T. (2002). Dry matter content as a measure of dry matter concentration in plants and their parts. *New Phytologist*, 153: 359-365.
- Sitaramam V, Madhavarao C.N. (1997). The Energetic basis of Osmotolerance in plants: Physical principles. *Journal of Theoretical Biology*, 189: 333-352.
- Slater M. (1967). Manometric methods and phosphate determination. *Methods in Enzymology*, 10: 19-29.
- Smith B.N, Lytle C.M, Hansen L.D. (1995). Predicting plant growth rates from dark respiration rates: an experimental approach. In: Proceedings: wildland shrub and arid land restoration symposium, Editors: Roundy B.A, McArthur E.D, Haley J.S, Mann D.K. 1993 October 19-21; Las Vegas, NV. Gen. Tech. Rep. INT-GTR=315. Ogden, UT: U.S. Department of agriculture, Forest Service, Intermountain research Station. http://www.fs.fed.us/rm/pubs/int_gtr315/4_smith.pdf.
- Sokal R.R, Rohlf F.J. (1995). Biometry: the principles and practice of statistics in biological research, 3rd edition. Freeman WH, San Francisco.
- West G.B, Savage V.M, Gillooly J, Enquist B.J, Woodruff W.H, Brown J.H. (2003). Why does metabolic rate scale with body size? and the subsequent correspondence. *Nature*, 421: 713-714.
- Yin X, Struik P.C, Kropff M.J. (2004). Role of crop physiology in predicting gene-to-phenotype relationships. *Trends Plant Science*, 9: 426-432.